

Installation

What's included

Make sure all the supplied parts and accessories are included in the product package (see page 14). If you have a question about the dryer or the accessories, contact a local Samsung service center or the retailer.

Dryer at a glance

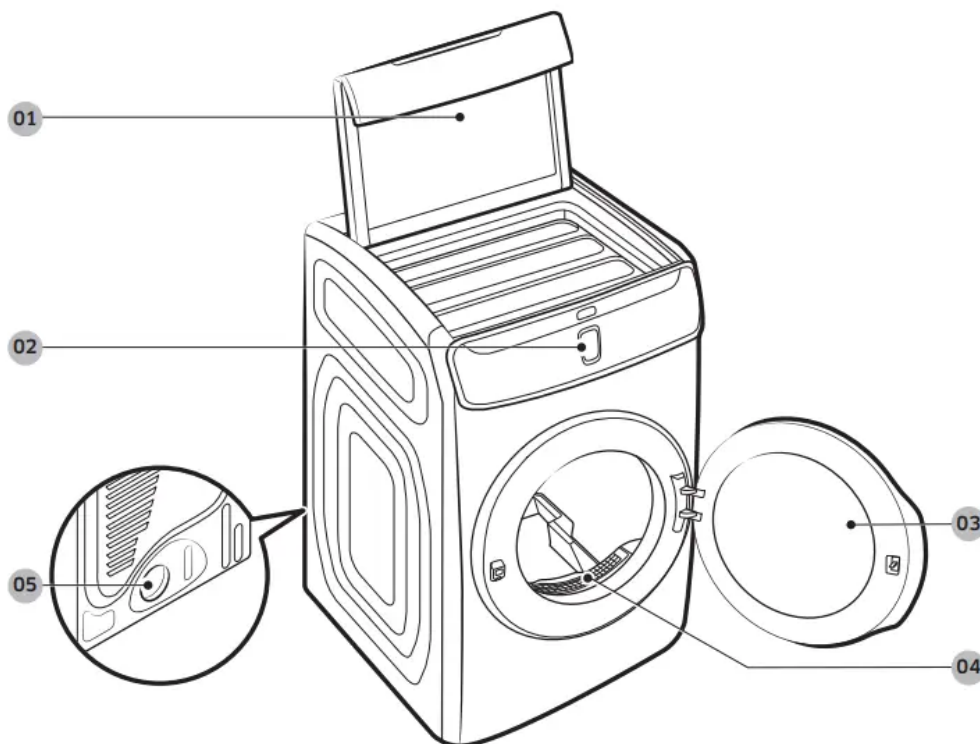

- 01. Top door
- 02. Main panel
- 03. Front door
- 04. Lint filter
- 05. Exhaust duct

Accessories (supplied)



Y connector



Water hose (Canadian elec. models only)



Short water hose



Flexible rack

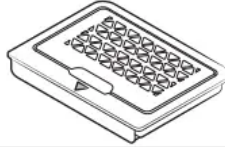

Dryer-sheet case

Accessories (not supplied)

You must purchase these items at a local service center.



Pedestal

Alcove or closet installations

Minimum clearances between the dryer and adjacent walls or other surfaces:



Sides	1 in. (25 mm)	Rear	6 in. (152 mm)
Top	21 in. (533 mm)	Closet front	2 in. (51 mm)

Installation with pedestal

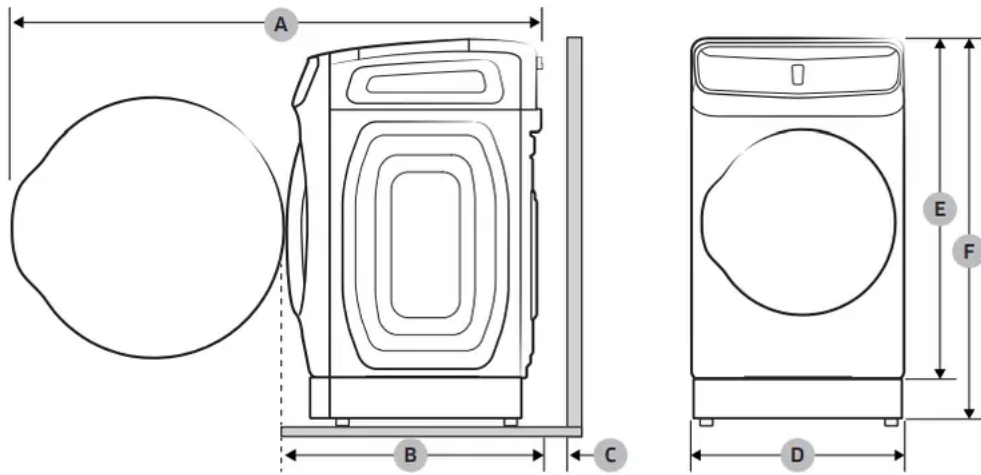

A	53.7 in. (1365 mm)	D	27 in. (686 mm)
B	32.5 in. (825 mm)	E	46.9 in. (1192 mm)
C	6 in. (152 mm)	F	52.2 in. (1326 mm)

Side by side installation

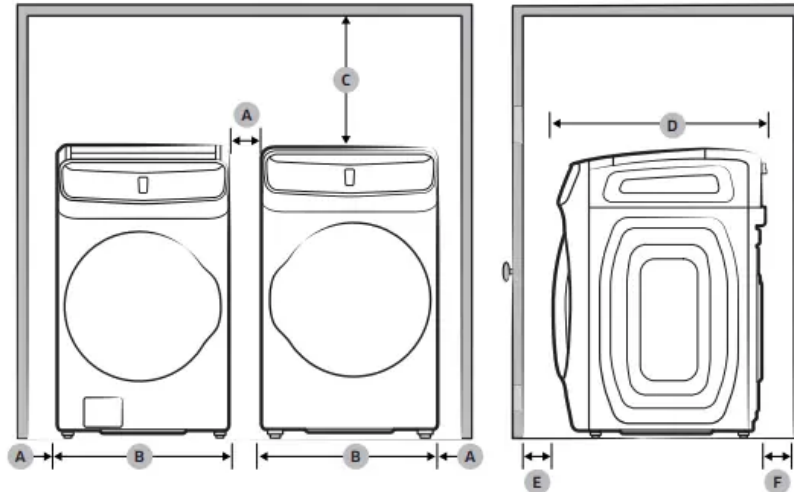

A	1 in. (25 mm)	D	32.5 in. (825 mm)
B	27 in. (686 mm)	E	2 in. (50 mm)
C	21 in. (533 mm)	F	6 in. (152 mm)

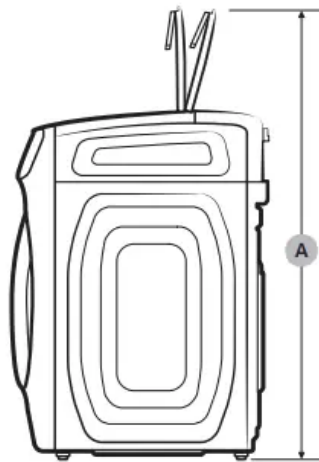

A	61 in. (1550 mm)
----------	------------------

Before you start

Sort and load

- Put one wash load in the dryer at a time.
- Do not mix heavy and lightweight items together.
- To improve drying efficiency for one or two items, add a dry towel to the load.
- For best results, untangle items before inserting them into the dryer. Tangled items may degrade the drying efficiency or cause the door to open.
- Overloading reduces the tumbling action, resulting in uneven drying and wrinkling. Unless recommended on the care label, do not dry woolens or fiberglass items.
- Avoid drying unwashed items.

- Do not dry items soiled with oil, alcohol, gasoline, etc.

Functional prerequisite

Lint filter

To prevent a risk of fire, make sure to clean the lint filter before or after every load.

1. Turn off the dryer.
2. Open the door and pull out the lint filter (A) from inside the drum.
3. Open the lint filter by separating it at the top. Remove the lint, and then clean the lint filter.
4. Close the lint filter, reinsert the lint filter into the dryer, and then close the dryer door.

CAUTION

- Do not operate the dryer without the lint filter in place.
- Do not use a damaged or broken lint filter. This may reduce performance and/or cause fire.

Drying guidelines

The best way to dry items is to follow the instructions on the care label. If no drying instructions are provided, see the following table for reference.

Cycle	Description
Bedspreads & Comforters	<p>Follow the care label instructions or dry using NORMAL.</p> <ul style="list-style-type: none"> • Make sure the item is thoroughly dry before using or storing. • May require repositioning in the drum to ensure even drying.
Blankets	<p>Use NORMAL and dry only one blanket at a time for best tumbling action.</p> <ul style="list-style-type: none"> • Make sure blankets are thoroughly dry before using or storing.
Curtains & Draperies	<p>Use PERM PRESS and the Medium temperature setting to help minimize wrinkling.</p> <ul style="list-style-type: none"> • Dry curtains and draperies in small loads for best results and remove as soon as possible after the cycle is complete.
Cloth Diapers	<p>Use NORMAL and the Medium temperature setting for soft, fluffy diapers.</p>
Down-filled Items (jackets, sleeping bags, comforters, etc.)	<p>Use NORMAL and the Medium temperature setting.</p> <ul style="list-style-type: none"> • Add a couple of dry towels to absorb moisture and shorten drying time.
Foam Rubber (rug backs, stuffed toys, shoulder pads, etc.)	<p>Do not dry on a heat setting. Use AIR FLUFF.</p> <p>WARNING</p> <p>Drying a rubber item with heat may damage it or cause a fire.</p>
Pillows	<p>Use NORMAL.</p> <ul style="list-style-type: none"> • Add a couple of dry towels and a pair of clean sneakers to help the tumbling action and to fluff the pillows. • Do not dry kapok or foam pillows using a heated drying cycle.



	You can dry these items in the dryer only if you use AIR FLUFF.
Plastics (shower curtains, outdoor furniture covers, etc.)	Use AIR FLUFF or TIME DRY and the Low or Extra Low temperature settings depending on the care label instructions.

Operations

This FlexDry™ dryer features the Delicate Dryer and the Tumble Dryer for your convenience. The Delicate Dryer is a top load dryer that is designed to dry relatively small loads while the Tumble Dryer is a drum loader you can use to dry normal or relatively heavy loads. The main panel is divided into 2 independent control panels.

WARNING To reduce the risk of fire, electric shock, or injury, read the Safety information section before operating this dryer.

CAUTION Do not spray water onto the main panel . This may cause a system failure.

Delicate Dryer

Control panel

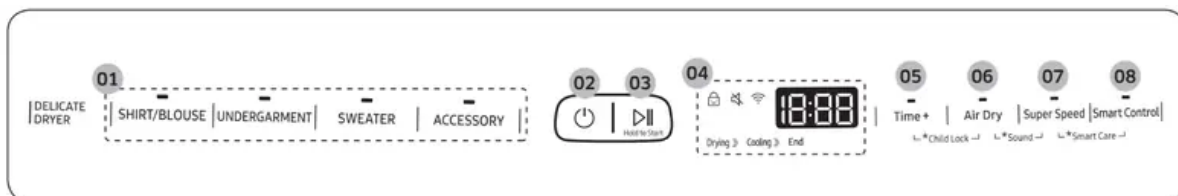

01 Cycle bar	Press to select a cycle
02 POWER	Press to turn the Delicate Dryer on or off
03 START/PAUSE (Hold to Start)	Press to start operation, or press to stop operation temporarily.
04 Status bar	The status bar shows current cycle information and estimated time remaining or an information code if the Delicate Dryer needs to be checked.
05 Time+	Press to increase the drying time in 20-minute increments. You can adjust the drying time up to 100 minutes according to the type and amount of the clothing.
06 Air Dry	You can dry heat-sensitive clothing without heat, in room temperature air. Such clothing may require more time to dry. To extend the drying time, use Time+. This option is for the “shirt/ blouse”, “undergarment” and “accessory” cycle.
07 Super Speed	Super Speed increases the fan speed to shorten the drying time. This option is for the “shirt/blouse”, “undergarment” and “accessory” cycle.
08 Smart Control (Elec.) / Smart Monitor (Gas)	Press to turn the Smart Control function on or off. You can control or monitor the dryer remotely. When started, the Smart Control (Smart Monitor) indicator blinks. For details, see the Samsung Smart Home section later in this manual.

Cycle overview

Each cycle of the Delicate Dryer has a predefined drying time. You must adjust the drying time manually if necessary. To extend the drying time, use Time+.

Cycle	Description
SHIRT/BLOUSE	<ul style="list-style-type: none"> • For synthetic blouses and blouses with accessories (ornaments)
UNDERGARMENT	<ul style="list-style-type: none"> • For synthetic reshaping innerwear, innerwear with laces, spandex fabrics for Pilates or Yoga, and leggings
SWEATER	<ul style="list-style-type: none"> • For washable wool or wool-blended sweaters, cotton or cotton-blended sweaters, and knitted cardigans
ACCESSORY	<ul style="list-style-type: none"> • For scarfs, mufflers, gloves, and stockings



NOTE

- Make sure you input items appropriate to the selected cycle. Overloads may delay the drying time. To extend the drying time, use Time+.
- Stretch out the items as straight as possible. Overlapping items may not dry well.
- Use the Tumble Dryer for blue jeans, thick clothing, or towels.
- The drying time may depend on the load conditions. To shorten, use a higher spinning speed.
- For manual-wash items, use a towel to remove moisture from the items before drying.

Recommended for the Delicate Dryer

- The drying time depends on the load and the item type. To shorten the drying time, use Super Speed.
- Overloads may delay the drying time. To extend the drying time, use Time+.
- For manual-wash items, use a towel to remove moisture from the items before drying.
- For machine-washable items, you can reduce the drying time by choosing a higher spinning rate.
- Arrange items as even and straight as possible. Overlapped items may not be dried well. Available or recommended items for a specific cycle are as below:

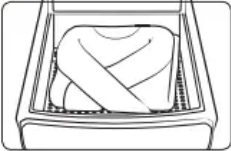

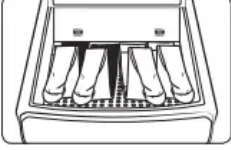
Cycle	Picture	Load	Item
SWEATER		1 EA (max. 2 EA)	Wool or wool-blended sweaters, cotton or cotton-blended sweaters, knitted cardigans
SHIRT/BLOUSE		1 EA (max. 2 EA)	Synthetic blouses, blouses with accessories (ornaments)
UNDERGARMENT		3 EA (max. 6 EA)	Synthetic reshaping innerwear, innerwear with laces, spandex fabrics for Pilates or Yoga, leggings
ACCESSORY		2 EA (max. 4 EA)	Scarfs, mufflers, gloves, stockings

The max load is calculated on the condition of using the drying rack.

Caution: Clothing with accessories or hooks may get stuck in the mesh of the rack.

- Clothing with accessories must face upwards.
- Clothing with hooks must be hooked up before being placed.

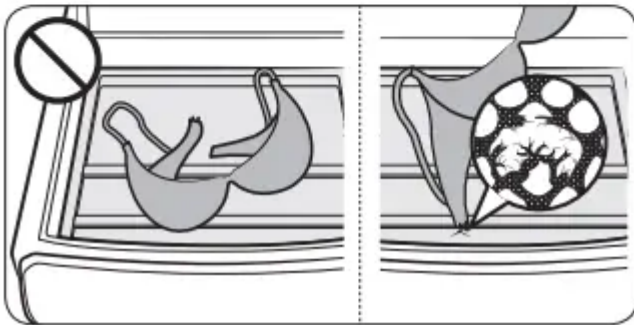
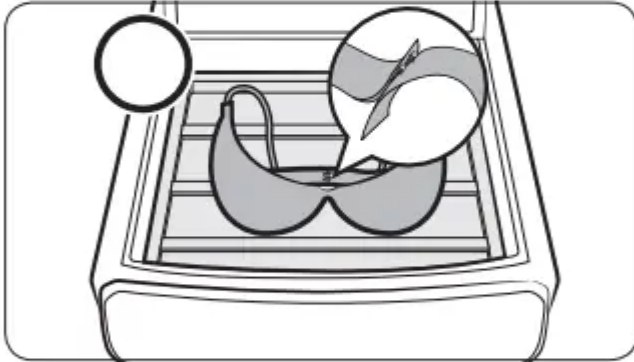
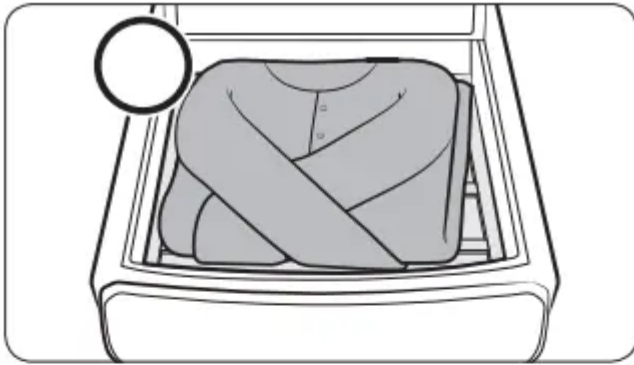

Not Recommended for the Delicate Dryer

Do not dry shoes, bags, down/fur products, rugs, carpets, or bulky items in the Delicate Dryer.

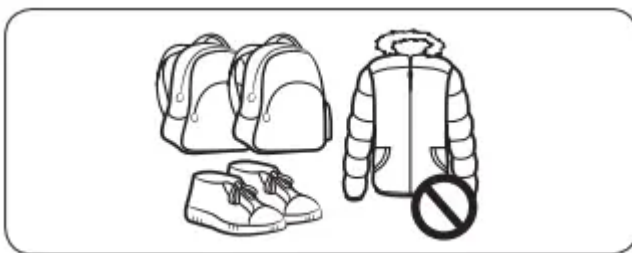

Use the Tumble Dryer for normal items (ex: blue jeans, bulky cotton items, towels, etc.)



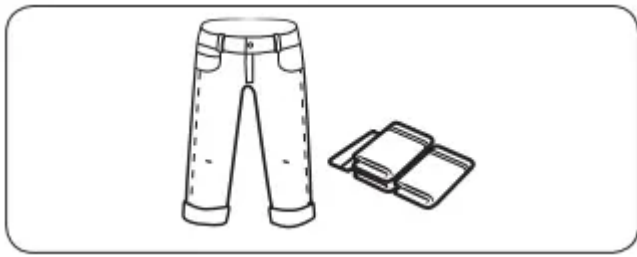

Tumble Dryer

Control panel

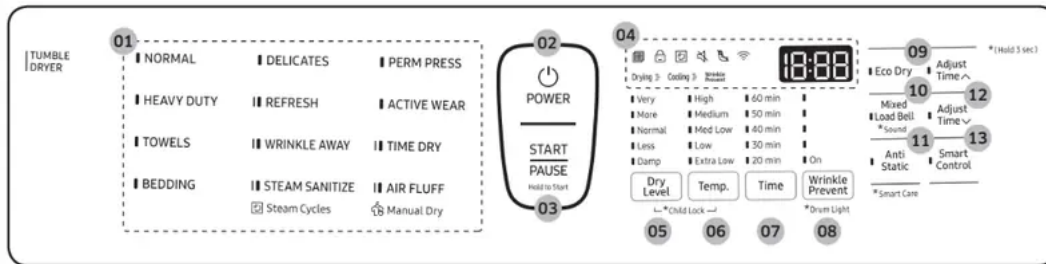

<p>01 Cycle area</p>	<p>Press a cycle name to select a cycle.</p> <ul style="list-style-type: none"> • Sensor Dry cycles: The dryer senses its internal humidity and shuts off when the internal humidity level indicates that the load is dry. This category includes NORMAL, HEAVY DUTY, TOWELS, BEDDING, DELICATES, PERM PRESS, and ACTIVE WEAR. • Steam Dry cycles: The dryer sprays water into the drum to deodorize clothes and reduce static electricity and wrinkles. <p>This category includes REFRESH, WRINKLE AWAY, and STEAM SANITIZE.</p> <ul style="list-style-type: none"> • Manual Dry cycles: The drying time is fixed. <p>This category includes TIME DRY and AIR FLUFF.</p>
<p>02 POWER</p>	<p>Press to turn the Tumble Dryer on or off.</p>
<p>03 START/PAUSE (Hold to Start)</p>	<p>Press and hold to start operation or press to stop operation temporarily.</p>
<p>04 Status bar</p>	<p>The status bar shows current cycle information and estimated time remaining or an information code if the Tumble Dryer needs to be checked.</p>
<p>05 Dry Level</p>	<p>Press Dry Level to select a dry level.</p> <ul style="list-style-type: none"> • Larger or bulkier loads may require Very or More for complete dryness. • The Less dry level is best suited for lightweight fabrics or for leaving some moisture in the clothing at the end of the cycle. • The Damp dry level is designed to partially dry items. Use for items that lay flat or hang to dry. <p>NOTE</p> <p>This option is not available with: REFRESH, WRINKLE AWAY, STEAM SANITIZE, ACTIVE WEAR, TIME DRY, and AIR FLUFF.</p>

<p>06 Temp.</p>	<p>Press Temp. to change the temperature of the current cycle.</p> <p>High: For sturdy cottons or those labeled Tumble Dry.</p> <p>Medium: For permanent press, synthetics, lightweight cottons, or items labeled Tumble Dry Medium.</p> <p>Med Low: For heat lower than Medium. Use to dry synthetic or washable knit fabrics.</p> <p>Low: For heat sensitive items labeled Tumble Dry Low or Tumble Dry Warm.</p> <p>Extra Low: Provides the lowest heated drying temperature possible.</p>
<p>07 Time</p>	<p>Press Time to select a drying time for the selected cycle. This is available only with TIME DRY, AIR FLUFF, and WRINKLE AWAY. This button is not available for Sensor Dry cycles because exact drying times are determined by fluctuating humidity levels.</p>
<p>08 Wrinkle Prevent</p>	<p>Wrinkle Prevent provides approximately 180 minutes of intermittent tumbling in unheated air at the end of the cycle to reduce wrinkling. Press Wrinkle Prevent to activate this feature. The load is dry and can be removed at any time during the Wrinkle Prevent cycle.</p>
<p>09 Eco Dry</p>	<p>This function is available with NORMAL and TIME DRY.</p> <p>With the Eco Dry activated, drying takes a longer time but power consumption is reduced.</p> <p>The drying time can be extended by up to 3 times normal depending on the temperature and load. The Eco Dry function is enabled by default.</p>
<p>10 Mixed Load Bell</p>	<p>The Mixed Load Bell notifies you when the average dry level in a load is damp dry (80 % dried). This lets you take items that you don't want fully dried or that dry quickly out of the dryer early while letting others continue to dry.</p> <p>You can select this option in all Sensor Dry cycles except for ACTIVE WEAR, and STEAM SANITIZE. Available dry levels are Normal, More, and Very.</p>



<p>11 Anti Static</p>	<p>Anti Static reduces static electricity that occurs from clothing friction. This is done by spraying steam into the drum in a later stage of the drying cycle.</p> <p>NOTE</p> <p>The Anti Static function is only available with NORMAL, HEAVY DUTY, PERM PRESS, DELICATES, and TIME DRY.</p>
<p>12 Adjust Time</p>	<p>You can change the set time for the selected cycle. This is available only with TIME DRY, AIR FLUFF, and WRINKLE AWAY. To change the cycle time, press Adjust Time /s, or Adjust Time v until the desired time is displayed.</p>
<p>13 Smart Control (Elec.) / Smart Monitor (Gas)</p>	<p>After connecting the Tumble Dryer to your home network using the Samsung Smart Home app, you can control or monitor the dryer remotely. When started, the Smart Control (Smart Monitor) indicator blinks. The dryer enters waiting mode and waits for remote commands.</p>

Cycle overview

Sensor Dry



Cycle	Description
NORMAL	<ul style="list-style-type: none"> • For most fabrics including cottons and linens. • If NORMAL is selected, the Eco Dry function is enabled by default. For more information, see Eco Dry in the Control panel section.
HEAVY DUTY	<ul style="list-style-type: none"> • For drying items made out of heavy fabrics, such as jeans, corduroys, or work clothes, with high temperature heat.
TOWELS	<ul style="list-style-type: none"> • For bath towels and similar items.
BEDDING	<ul style="list-style-type: none"> • For bulky items such as blankets, sheets, and comforters.
DELICATES	<ul style="list-style-type: none"> • For heat-sensitive items at a low drying temperature.
PERM PRESS	<ul style="list-style-type: none"> • Use to dry wrinkle-free cottons, synthetic fabrics, knits, and permanent press fabrics automatically.
ACTIVE WEAR	<ul style="list-style-type: none"> • For exercise wear and outdoor wear such as sports jerseys, training pants, water-repellent jackets, and other performance clothing. • Thick fabrics like a zipper or velcro closure on a jacket, or training socks may not be completely dried.

Steam Cycles

Cycle	Description
REFRESH	<ul style="list-style-type: none"> • Use to smooth out wrinkles and reduce odors in loads of one to four items. With this cycle selected, a small amount of water is sprayed into the dryer drum after several minutes of tumbling with heat. Before removing the laundry, confirm that the laundry load is dry.
WRINKLE AWAY	<ul style="list-style-type: none"> • For best results, load 2-3 items at once. You can extend the drying time by a minimum of 20 minutes, depending on the item type or load. Before removing the laundry, confirm that the laundry load is dry.
STEAM SANITIZE	<ul style="list-style-type: none"> • Use to sanitize items by applying steam and high-temperature heat to the fabric. This cycle can make items soft and reduce smells. Confirm that the laundry load is wet or partially wet before starting this cycle.

Manual Dry

Cycle	Description
TIME DRY	<ul style="list-style-type: none"> • You can specify a cycle time in minutes. • If TIME DRY is selected, the Eco Dry function is enabled by default. For more information, see Eco Dry in the Control panel section.
AIR FLUFF	<ul style="list-style-type: none"> • Tumbles the load in room temperature air.

Simple steps to start

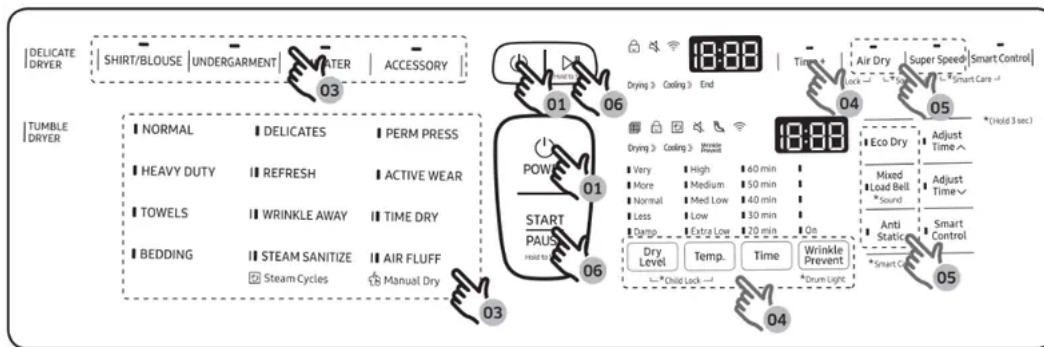

1. Press **POWER** on the control panel of a desired dryer (Delicate, Tumble) to turn the dryer on.
2. Put the items you want to dry into the dryer.
3. Select a cycle.
4. Change the cycle settings (temperature and/or dry level) as appropriate to the items.
5. Select cycle options as needed.
6. Press **START/PAUSE**.

To change the cycle during operation

1. Press **START/PAUSE** to stop operation temporarily.
2. Select a different cycle.
3. Press **START/PAUSE** again to start the new cycle.

This product is a smart dryer that supports the Samsung Smart Home service. The amount of time the EZ setup function (for connecting the dryer to your network) can take to complete the network connection varies, depending on your network conditions.

Samsung Smart Home

Installation

Visit the Google Play Store, Galaxy Apps, or Apple App Store and search for “Samsung Smart Home”. Download and install the Samsung Smart Home app provided by Samsung Electronics to your smart device.

NOTE

- The Samsung Smart Home app is designed for Android 4.0 (ICS) or higher, or iOS 8.0 or higher, and is optimized for Samsung smartphones (Galaxy S and Galaxy Note series).
- On other devices, some functions may operate differently.

- For improved performance, the Samsung Smart Home app is subject to change without notice.

Registering a Samsung account

To use the Samsung Smart Home app, you must first sign in to your Samsung account. If you don't have a Samsung account, select Register in the app, and then follow the on screen instructions to create an account.

NOTE

- If you have a registered Samsung account, log into your Samsung account. If you have a Samsung smartphone, you can go to the Settings menu on your smartphone, select Accounts, and then sign in to your Samsung account. This will allow you to log in without additional authentication.
- For third-party smart phones, the app account must be the same as the EZ Setup account

Getting started

Using Samsung Smart Home, you can control your dryer from your smart device remotely.

For improved performance, the content and design of the app is subject to change without notice.

1. Launch the Samsung Smart Home App on your smartphone.
 2. If 'Dryer' is not listed, tap **Add Device > Select other device > Dryer** on the app screen.
 3. Press and hold Smart Control on your dryer's control panel for more than 5 seconds until the '**AP**' message appears on the display.
 4. When the device registration is complete, turn on the Smart Control function on your dryer and you can monitor (gas models) or control (electric models) your dryer remotely.
- For gas models, the Dryer app only serves as a monitoring device. You cannot use any of the controls available on the app.

Special features

Child Lock

To prevent children or infants from accidentally starting the dryer or setting any of the dryer's functions, Child Lock locks all buttons except for the POWER button. Note that each dryer operates independently and has its own Child Lock function.

To activate the Child Lock

- Press and hold **Dry Level** and **Temp.** (or Time+ and Air Dry for the Delicate Dryer) simultaneously for 3 seconds. Then, press **START/PAUSE** to activate. The door locks and the Child Lock indicator turns on.

To deactivate Child Lock temporarily

- You can deactivate Child Lock temporarily for 1 minute. To do this, press and hold Dry Level and Temp. (or Time+ and Air Dry for the Delicate Dryer) simultaneously for 3 seconds. The door is unlocked for 1 minute and the Child Lock indicator blinks

To cancel Child Lock

- Press and hold Dry Level and Temp. (or Time+ and Air Dry for the Delicate Dryer) for 3 seconds to deactivate, and then press and hold the buttons again for 3 seconds to release Child Lock. The door unlocks and the Child Lock indicator turns off.

Smart Care

The Smart Care function helps you diagnose and troubleshoot your dryer if it has a problem. To enable this function, you must first download the Samsung Smart Dryer app from the Play Store or the Apple Store, and then install it on a mobile device that has a built-in camera. The Smart Care function has been optimized for Galaxy and iPhone series devices. (It is not supported by some models.)

As the dryer operates, it runs a self-diagnosis function in the background. If it senses a problem, it displays an information code on the display which you can scan using the app's Smart Care function. The Smart Care function will then display detailed information about the code.

1. Press and hold Wrinkle Prevent (or Smart Care for the Delicate Dryer) on the dryer for 3 seconds to enter the Smart Care mode.
2. Run the Samsung Smart Dryer app on your mobile device, and then tap Smart Care.
3. Hold the mobile device so that the mobile device and the dryer's status bar face each other. The app will recognize the information code automatically.
4. When the information code is recognized correctly, the app provides detailed information about the symptom and recommends further action.

Sound

Mute or unmute the sound (button beeps, indicator beeps and chimes, etc.)

Delicate Dryer

- To mute the dryer's alarm sound or beeps, press and hold Air Dry and Smart Care for 3 seconds. To unmute, press and hold the same buttons for 3 seconds again.

Tumble Dryer

- To mute the dryer's alarm sound or beeps, press and hold Anti Static for 3 seconds. To unmute, press and hold the same button again for 3 seconds.

Drum Light (Tumble Dryer only)

The drum light turns on when the door is opened and turns off after 2 minutes. To manually turn the drum light on or off, press and hold Time for 3 seconds.

Maintenance

Keep your FlexDry™ dryer clean to prevent decreased performance and to lengthen its life

General cleaning and maintenance instructions

Main panel

- Clean with a soft, damp cloth. Do not use abrasive substances.
- Do not spray liquid cleaning agents directly onto the dryer display.
- Some laundry pre-treatment soil and stain removers may damage the control panel.
- When using liquid cleaning agents, apply them to the cleaning cloth. Do not apply them directly to the dryer. Wipe up any spills or overspray immediately.

Exterior

- Clean with a soft, damp cloth. Do not use abrasive substances.
- Protect the surface from sharp objects.
- Do not place any heavy or sharp objects or a detergent container on the dryer. They can scratch or damage the top cover of the dryer.
- The dryer has a high-gloss finish on the entire surface. Be careful not to scratch or damage the surface.

Exhaust system

- Check and clean the exhaust system on a regular basis to maintain optimum performance.
- The external exhaust hood must be cleaned frequently to ensure proper air flow.

Vent sensor

The dryer features a vent sensor that detects and notifies you when it is time to clean the ductwork. The  indicator lets you know the status of the duct.

Level	 Indicator	Status	Action
0	Off	The ductwork is not clogged.	-
1	On	<ul style="list-style-type: none"> • The duct or lint filter is clogged. • High pressure being applied to the duct because the duct is too long or bent. 	<ul style="list-style-type: none"> • Check the lint filter or duct and clean if necessary. • Check the duct connections and shorten or straighten the duct if necessary.
2	Blinking	<ul style="list-style-type: none"> • The duct or lint filter is severely clogged. • The pressure applied to the duct is very high because the duct is too long or bent. 	<ul style="list-style-type: none"> • Check and clean the lint filter or duct and make sure they are not clogged. • Check the duct connections and shorten or straighten the duct work.

If the dryer is in the Level 2 state, the  indicator blinks for 3 hours after the completion of the current cycle. If you press **POWER** or open the door, the dryer powers off immediately

Delicate Dryer

Flexible rack

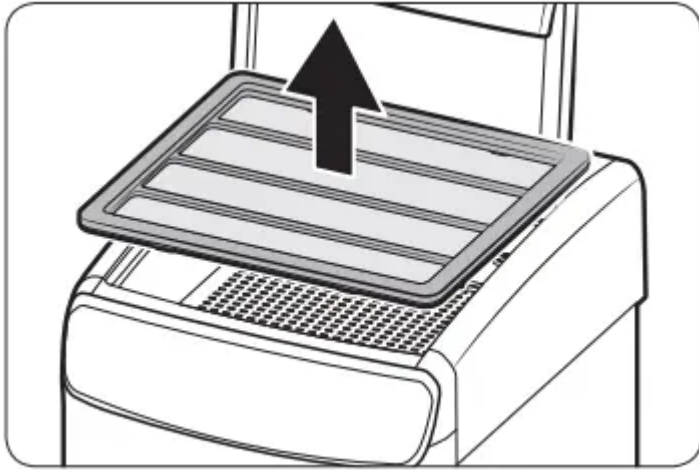

- If you use the flexible rack, make sure to clean the rack after every use so that it is readily available for future use.
- Clean the rack with neutral cleaning agents and running water.

Upper recesses

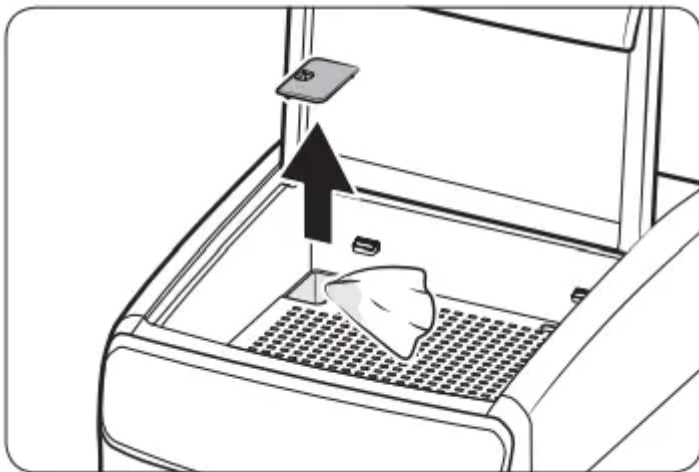

- Clean the left and right rear recesses of the Delicate Dryer after every use.
- Locate the recesses in the rear corners of the Delicate Dryer, and then remove the recess covers on both sides.
- The Delicate Dryer may have collected water while it is operating. After every use or while the Delicate Dryer is operating, remove the covers of the rear recesses, and then clean the recesses using a soft dry cloth.
- By design, the surface of the Delicate Dryer is slanted to facilitate collection of water.

Dryer-sheet case

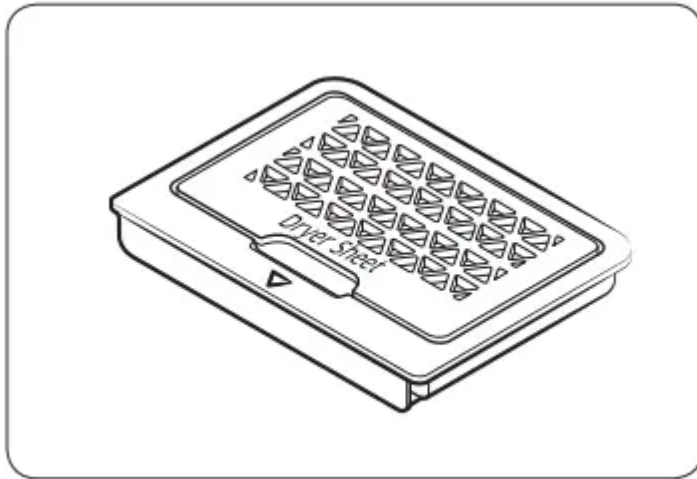

- Clean the Dryer-sheet case with neutral cleaning agents and running water.

Tumble Dryer

Stainless steel drum

- Clean the drum after every use.
- To clean the stainless steel drum, use a damp cloth with a mild, non-abrasive cleaner suitable for easily marred surfaces. Remove cleaner residue and dry with a clean cloth.

Drying rack

- If you used the lower drying rack, make sure to clean the rack after every use so that it will be readily available for future use.
- Clean the drying rack with neutral cleaning agents and running water.

Troubleshooting

Checkpoints

If the dryer operates abnormally, first check the list of problems in the table below and try the suggested actions.

Symptom	Action
Does not run.	<ul style="list-style-type: none"> • Make sure the door is latched shut. • Make sure the power cord is plugged into a live electrical outlet. • Check your home's circuit breakers or fuses. • Press and hold START/PAUSE again if the door was opened during a cycle. • Clean the lint filter. • If you are using the Delicate Dryer but it does not operate properly, you can turn the Tumble Dryer on and see if an information code appears.
Does not heat.	<ul style="list-style-type: none"> • Check your home's circuit breakers or fuses. • Some cycles do not require heat. Check the selected cycle again. • For a gas dryer, make sure the gas supply is on. • Clean the lint filter and exhaust duct. • The dryer may have moved into the cool-down phase of the cycle.



<p>Does not dry.</p>	<ul style="list-style-type: none"> • Check all of the above, plus... • Make sure the exhaust hood outside your home can open and close freely. • Check the exhaust system for lint buildup. Ducting should be inspected and cleaned annually. • Use a 4" rigid metal exhaust duct. • Do not overload. 1 wash load = 1 dryer load. • Dry heavy items and light weight items separately. • Large, bulky items, such as blankets or comforters, may require repositioning to ensure even drying. • The load may be too small to tumble properly. Add a few towels and restart the dryer. • The load may be too large to tumble properly. Remove some items and restart the dryer. • Clean the lint filter.
<p>Is noisy.</p>	<ul style="list-style-type: none"> • Check the load for objects such as coins, loose buttons, nails, etc. Remove promptly. • It is normal to hear the dryer gas valve or heating element cycle on and off during the drying cycle. • Make sure the dryer is leveled properly as outlined in the installation instructions. • It is normal for the dryer to hum due to the high velocity of air moving through the dryer drum, fan, or exhaust system.
<p>Dries unevenly.</p>	<ul style="list-style-type: none"> • Seams, pockets, and other similarly heavy areas may not be completely dry when the rest of the load has reached the selected dryness level. This is normal. You can choose a higher dryness level or a cycle that involves a higher dryness level. • If one heavy item is dried with a light weight load, such as one towel with sheets, it is possible that the heavy item will not be completely dry when the rest of the load has reached the selected dryness level. • For the best drying results, dry heavy items and light weight items separately.



<p>Has odors.</p>	<ul style="list-style-type: none"> • Household odors from paint, varnish, strong cleaners, etc. may enter the dryer with the surrounding room air. This is normal as the dryer draws the air from the room, heats it, pulls it through the drum, and exhausts it outside. • When these odors linger in the air, completely ventilate the room before using the dryer.
<p>Lint on clothes.</p>	<ul style="list-style-type: none"> • Make sure the lint filter is cleaned before every load. For clothes that naturally build up lint, clean the filter during the cycle. • Some fabrics are lint producers (for example, a fuzzy white cotton towel) and they must be dried separately from clothes that are lint trappers (for example, a pair of black linen pants). • Divide larger loads into smaller loads for drying. • Check pockets thoroughly before drying, then dry clothes. • Remove lint inside the drum before drying a load.
<p>Items still wrinkled after Wrinkle Prevent (Wrinkle Away, Wrinkle Release).</p>	<ul style="list-style-type: none"> • Small loads of 1 to 4 items work best. • Load fewer items. Load similar-type items. • Take out the items immediately after drying is complete.
<p>Water drips from the nozzle when the Steam cycles starts.</p>	<ul style="list-style-type: none"> • This is steam condensation. The dripping water will stop after a short time.
<p>Sprayed water is not visible during Steam cycles.</p>	<ul style="list-style-type: none"> • Sprayed water is difficult to see when the door is closed.
<p>Extended time.</p>	<ul style="list-style-type: none"> • Sensor Dry automatically senses the moisture in the load and shuts the dryer off when the selected dryness level is reached. • The drying time can change according to the type and amount of laundry. See the cycle chart for reference.

If a problem persists, contact a local Samsung service center.



Samsung Smart Home

Symptom	Action
<p>I could not find “Samsung Smart Home” in the app market.</p>	<ul style="list-style-type: none"> • The Samsung Smart Home app is available for smartphones that run Android 4.0 (ICS) or higher, or iOS 8.0 or higher.
<p>The Samsung Smart Home app fails to operate.</p>	<ul style="list-style-type: none"> • The Samsung Smart Home app is available for applicable models only. • The old Samsung Smart Dryer app cannot connect with Samsung Smart Home models.
<p>The Samsung Smart Home app is installed but is not connected to my dryer.</p>	<ul style="list-style-type: none"> • You must log into your Samsung account to use the app. • Use the Samsung Smart Home app to connect and register the dryer with your home network access point (AP). • Make sure that your router is operating normally.
<p>Could not log into the app.</p>	<ul style="list-style-type: none"> • You must log into your Samsung account to use the app. • If you don't have a Samsung account, follow the app's onscreen instructions to create one.
<p>An error message appears when I try to register my dryer.</p>	<ul style="list-style-type: none"> • The connection may fail due to the distance from your access point (AP) or electrical interference from the surrounding environment. Wait a moment and try again.
<p>The Samsung Smart Home app is successfully connected to my dryer but does not run.</p>	<ul style="list-style-type: none"> • Exit and restart the Samsung Smart Home app or unplug your router and then reconnect it.

Information codes

If the dryer fails to operate, you may see an information code on the display panel. To determine what you should do, check the list of codes in the table below, and then try the suggested actions

Code		Action
Delicate Dryer	Tumble Dryer	
1 dC	dC	<p>Operating the dryer with the door open.</p> <ul style="list-style-type: none"> • Make sure the door is properly closed. • Make sure laundry is not caught in the door.
1 FC	FC	<p>Invalid power source frequency.</p> <ul style="list-style-type: none"> • Try restarting the cycle. • If this information code remains, contact a Samsung service center.
1 AC	AC	<p>Electronic control problem [Invalid Communication (SUB PBA <-> MAIN PBA)].</p> <ul style="list-style-type: none"> • Contact a Samsung service center.
1 HC	HC	<p>High temperature heating check.</p> <ul style="list-style-type: none"> • Clean the lint filter. • If this information code remains, contact a Samsung service center.
-	9C1	<p>The electronic control needs to be checked.</p> <ul style="list-style-type: none"> • Check if power is supplied properly. • If the information code remains, contact a Samsung service center.
1 tC	tC	<p>The Thermistor1 resistance is very low or high.</p> <ul style="list-style-type: none"> • Check for a clogged lint screen . • Check if the vent system is restricted.

Code		Action
Delicate Dryer	Tumble Dryer	
		<ul style="list-style-type: none"> • If this information code remains, contact a Samsung service center.
1tC5	tC5	<p>The Thermistor2 resistance is very low or high.</p> <ul style="list-style-type: none"> • Check for a clogged lint screen. • Check if the vent system is restricted. • If this information code remains, contact a Samsung service center.
-	dF	<p>Incorrect door switch.</p> <ul style="list-style-type: none"> • Contact a Samsung service center.
1 AC7	-	<p>Electronic Control Problem [Invalid Communication (Delicate Dryer MAIN <-> Tumble MAIN PBA)].</p>

If any information code keeps appearing on the screen, contact a Samsung service center.

Warning

This content is compiled from multiple sources and is provided for reference purposes only. It may not be complete or fully applicable to all situations. If you are unable to resolve your issue, please contact the product manufacturer or an authorized service provider for official support.