

What is Included/TV Placement Setup

TV Stand Installation /Removal

43T7U

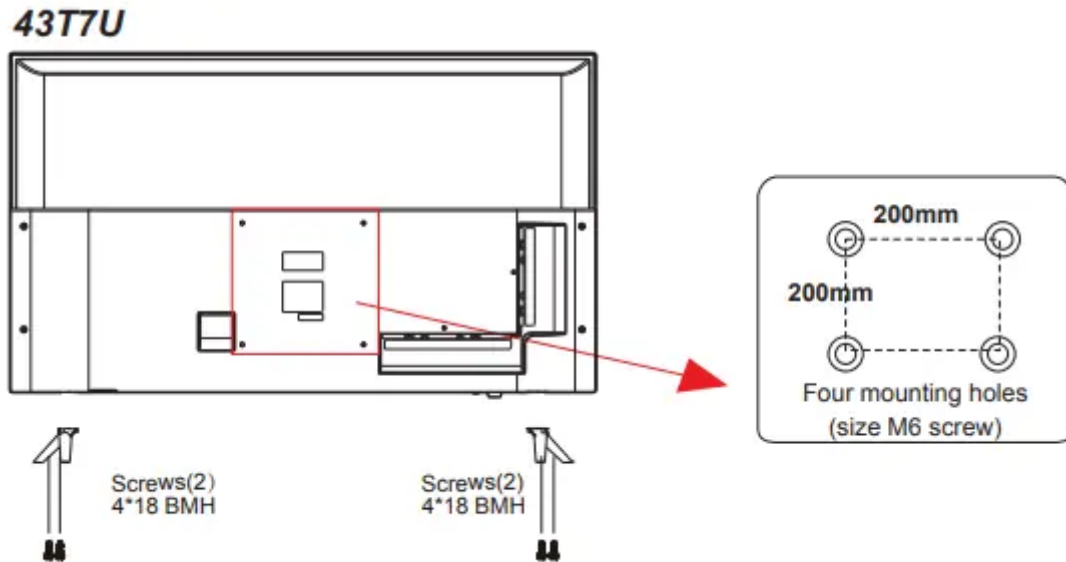

Wall Mounting

- The TV is provided with mounting holes for a VESA approved wall mounting bracket (NOT SUPPLIED). The VESA mounting pattern is 200 x 200 mm. Remove the screws holding the base to the base bracket and lift the base away (do not remove the base mounting brackets). Mount the VESA bracket using 4 x M6 x 20 isometric threaded screws (not supplied). Do not use screws longer than 20 mm; damage will occur to the internal components.
- Caution: Your new TV is heavy; please consult with a professional wall mount installer to perform this installation.

49T7U

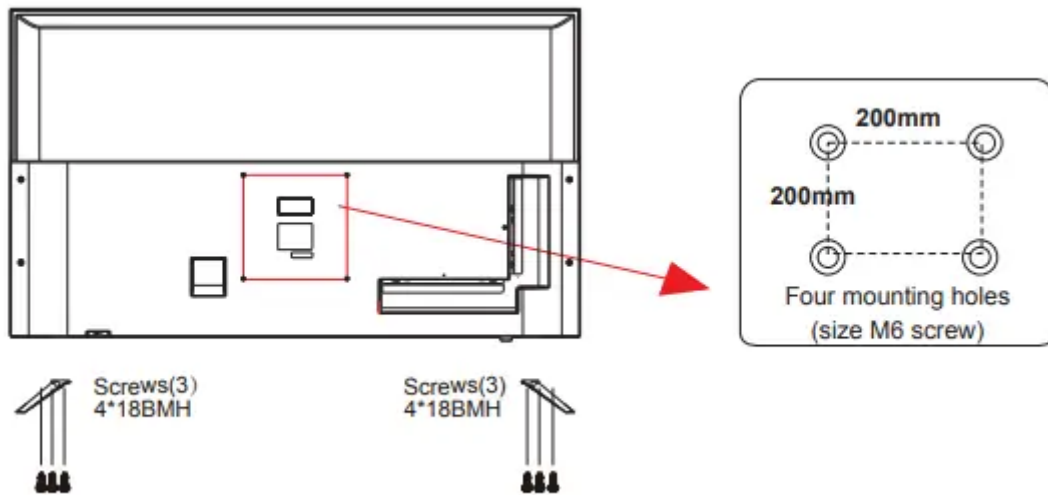

Wall Mounting

- The TV is provided with mounting holes for a VESA approved wall mounting bracket (NOT SUPPLIED). The VESA mounting pattern is 200 x 200 mm. Remove the screws holding the base to the base bracket and lift the base away (do not remove the base mounting brackets). Mount the VESA bracket using 4 x M6 x 20 isometric threaded screws (not supplied). Do not use screws longer than 20 mm; damage will occur to the internal components.
- Caution: Your new TV is heavy; please consult with a professional wall mount installer to perform this installation.

50T7U

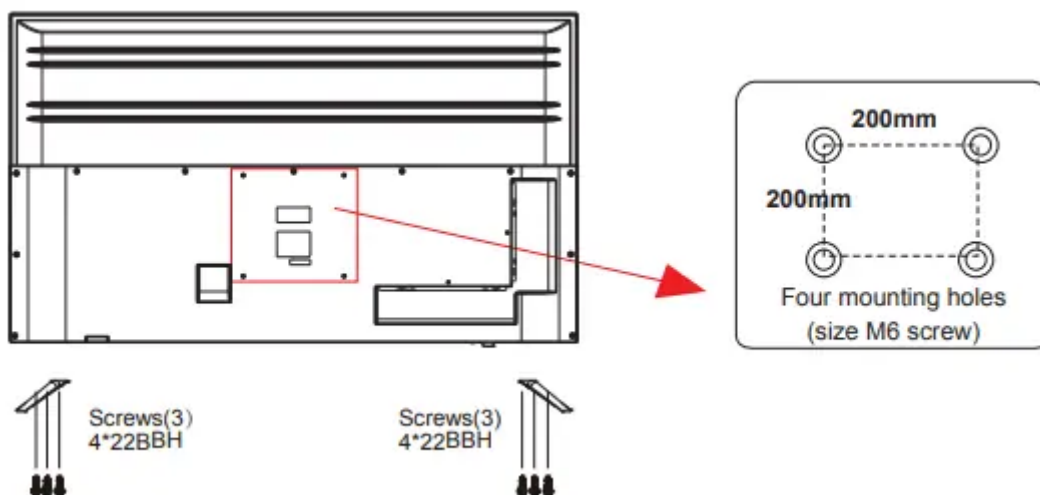

Wall Mounting

- The TV is provided with mounting holes for a VESA approved wall mounting bracket (NOT SUPPLIED). The VESA mounting pattern is 200 x 200 mm. Remove the screws holding the base to the base bracket and lift the base away (do not remove the base mounting brackets). Mount the VESA bracket using 4 x M6 x 20 isometric threaded

screws (not supplied). Do not use screws longer than 20 mm; damage will occur to the internal components.

- Caution: Your new TV is heavy; please consult with a professional wall mount installer to perform this installation.

55T7U

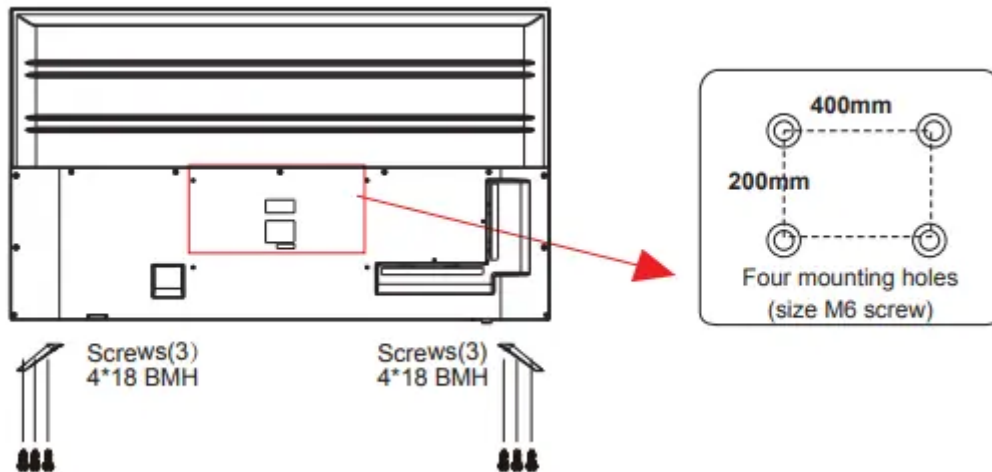

Wall Mounting

- The TV is provided with mounting holes for a VESA approved wall mounting bracket (NOT SUPPLIED). The VESA mounting pattern is 400 x 200mm. Remove the screws holding the base to the base bracket and lift the base away (do not remove the base mounting brackets). Mount the VESA bracket using 4 x M6 x 20 isometric threaded screws (not supplied). Do not use screws longer than 20 mm; damage will occur to the internal components.
- Caution: Your new TV is heavy; please consult with a professional wall mount installer to perform this installation.

Front/Back View

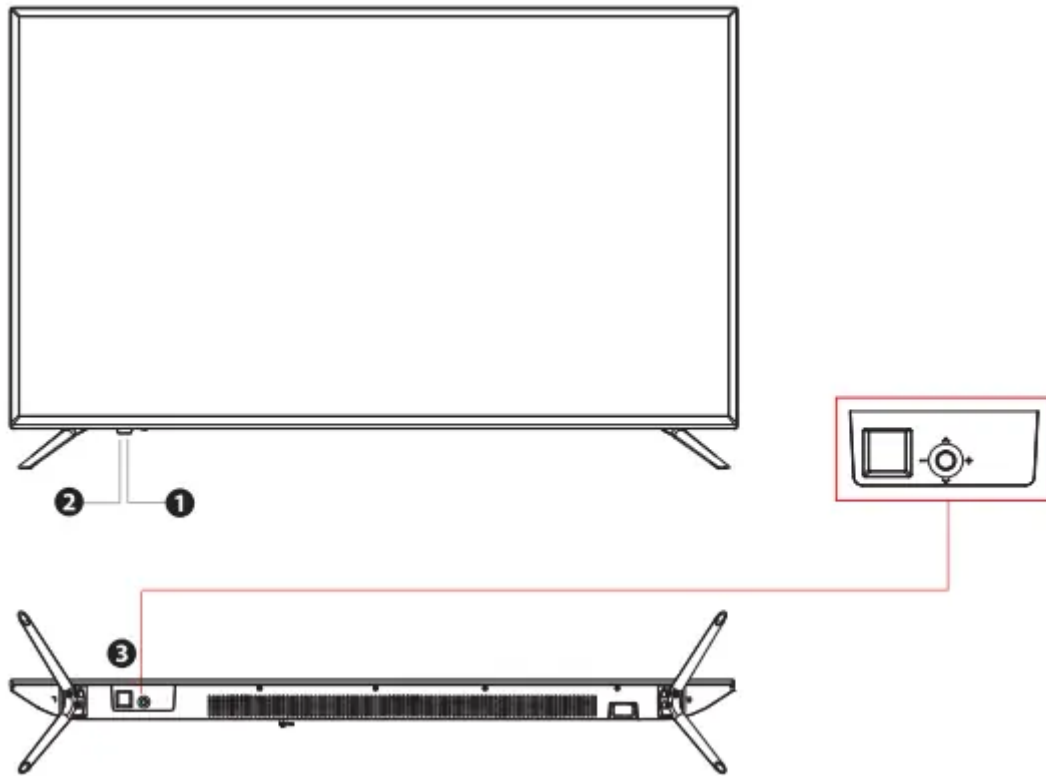

NOTICE: There is a square glue to protect the IR model, it can be removed after instal the base.

Button Functions

1. POWER LED: illuminates green when the TV is turned on. illuminates red when the TV is in standby mode.

2. IR(Infrared Receiver):

3.  POWER ON: Press the middle button. CH+: Push forward to choose the next higher channel in the channel list. CH-: Pull back to choose the next lower channel in the channel list. VOL+: Push right to increase the volume. VOL-: Push left to decrease the volume. QUICK MENU: Press the middle button for 2~5 seconds. MUTE: Press “ ^ ” to select press the middle button to enter. POWER OFF: Press “ ” to select press the middle button to turn off. MENU: Press “ - ” to select press the middle button to enter. INPUT: Press “ + ” to select press the middle button to enter

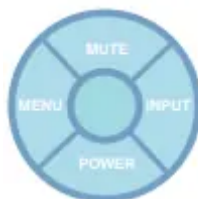

Connecting to External Devices



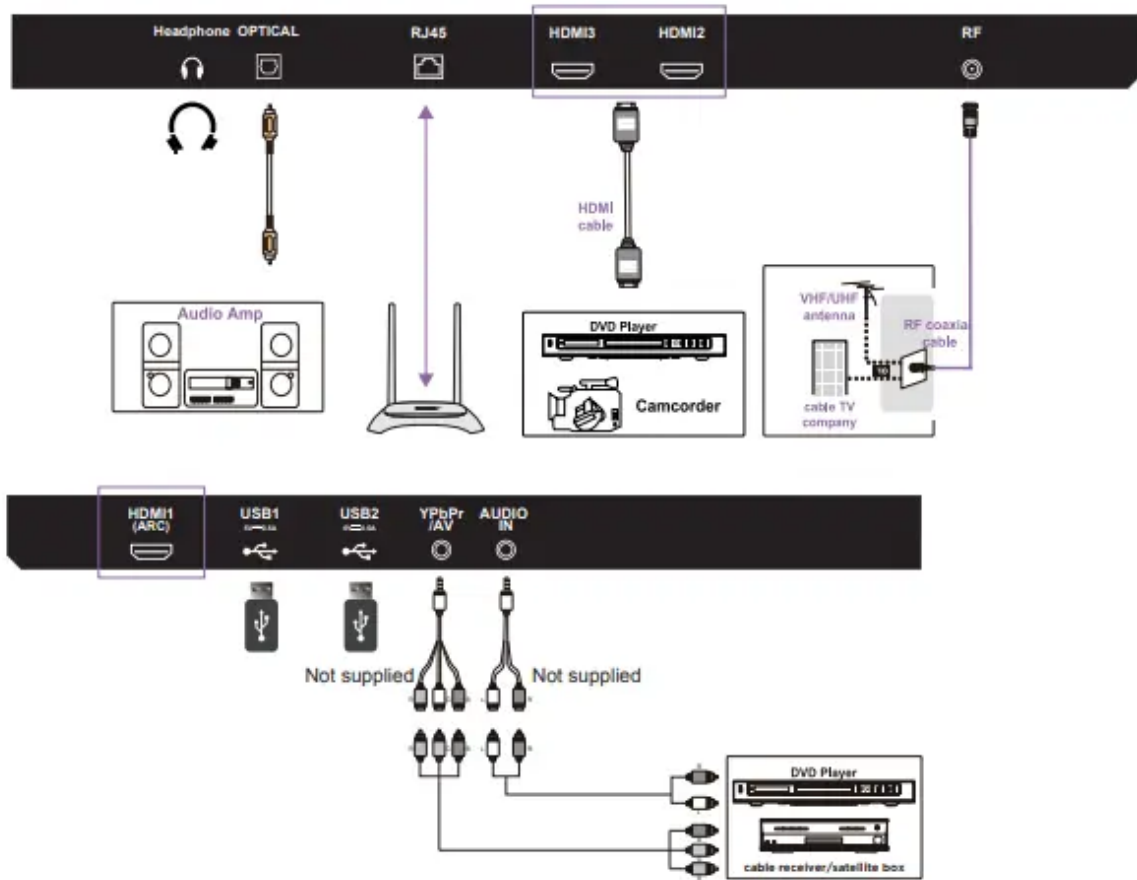

Connecting external devices to your LED TV

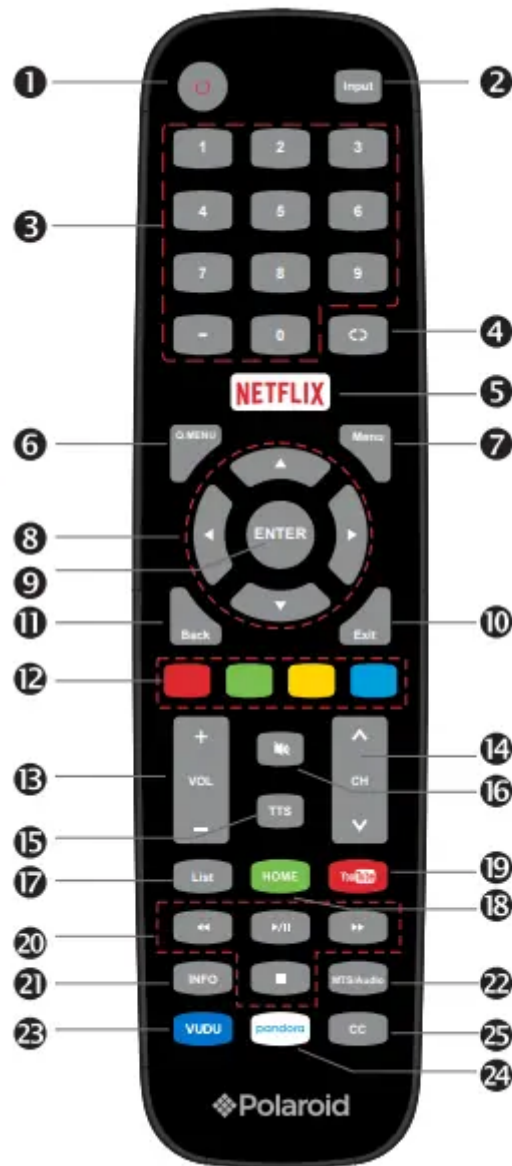

1. HEADPHONES :Connect to the Headphones.
2. OPTICAL:Connect a digital sound system to this jack.
3. RJ45:Network connection port.
4. HDMI :Connect to High-Definition(HD) signal output device.(HDMI can support 4K60Hz Signal)
5. RF: Connect to the antenna(75Ω VHF/UHF) socket with the RF coaxial cable.
6. USB
7. YPBPR/AV: Connect to the YPbPr video output terminal of the DVD. Connect video output from a DVD or VCR.
8. AUDIO IN: Audio input.

Remote Control



1. POWER: Turn the TV on and off
2. Input: This button is used to switch among different sources, Select a source and press ENTER button to confirm.
3. Digital Buttons(0-9, -): Directly select channel with digital buttons.
4.  : Switch to the previous program
5. NETFLIX: If network connects, press this key to view NETFLIX directly.
6. Q.MENU: Press this key to go to quick menu.
7. MENU: Display the main menu or exit the current menu.
8. Arrow buttons    : Use to select on-screen menu items and change menu values.

9. ENTER: Validation key.
10. Exit: Exit the menu.
11. Back: Return.
12. COLOR BUTTONS: It's used as it's showed in the EPG or Program Edit menu.
13. VOL+/-: Press these buttons to adjust the volume.
14. CH \wedge/\vee : Press these buttons to change channel upward or downward.
15. TTS: Press this button to set TTS on or off.
16. : Press this button to cut off the sound of the TV set temporarily, press again to resume.
17. List: Press it to show channel list and favorite list on screen.
18. HOME: Press it to go to App home page.
19. YouTube: If network connects, press this key to view YouTube directly
20. DIGITAL MEDIA PLAYER CONTROL BUTTON: Include play/pause, stop, backward, forward is used in USB mode .Please refer to relevnat instructions in the section of multimed player.
21. INFO: Display the program information .
22. MTS/AUDIO: In USB mode, press this button to switch audio track when movie is playing. In TV mode, press this button to switch MTS or Audio Language.
23. VUDU: Press this button to select VUDU application.
24. pandora: Press this button to select pandora application.
25. CC: Press this button to adjust CC mode.

Install the Batteries

If the remote control fails to operate the TV functions, replace the batteries in the remote control.

1. Open the battery compartment cover on the back side.
2. Insert two 1.5V AAA size batteries incorrect polarity. Don't mix old or usedbatteries with new ones.
3. Closed the cover.

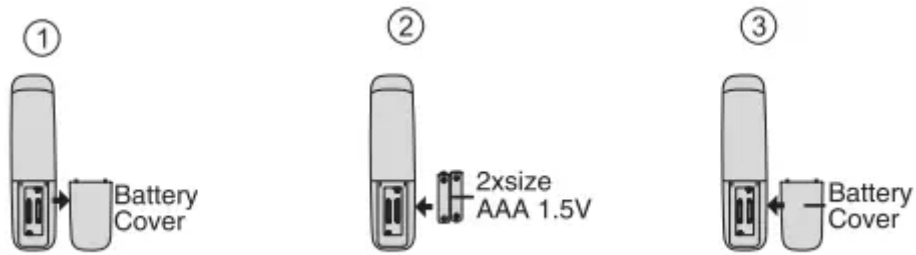

Initial Setup



1. Connecting your TV on the poweroutlet;
2. Press the POWER button on the remote to turn on the TV in green for the LED light.
CAUTION: Always disconnect the TV from the power outlet when the TV will not be used for a long period of time. The POWER button on the front panel is only used for switching the TV into standby, it does not disconnect the device from the main voltage. To completely disconnect the main voltage, please remove the power plug from the socket.
3. Press the key ▼ / ▲ / ◀ / ▶ and following the picture as bellow to operate the subject.

NOTE: The picture is for reference only.

Basic Operations

Menu Operation



Setup Wizard - Select OSD Language

- Press ▼ / ▲ button to select the language to be used for menus and message. Press ENTER button to enter the next menu.

DATA COLLECTION AND FIRMWARE UPDATES NOTICE

- Press ◀ / ▶ button to select.
- Press ENTER button to enter the next menu.
- Note: Select the “VIEW ADDITIONAL DETAILS” for more information

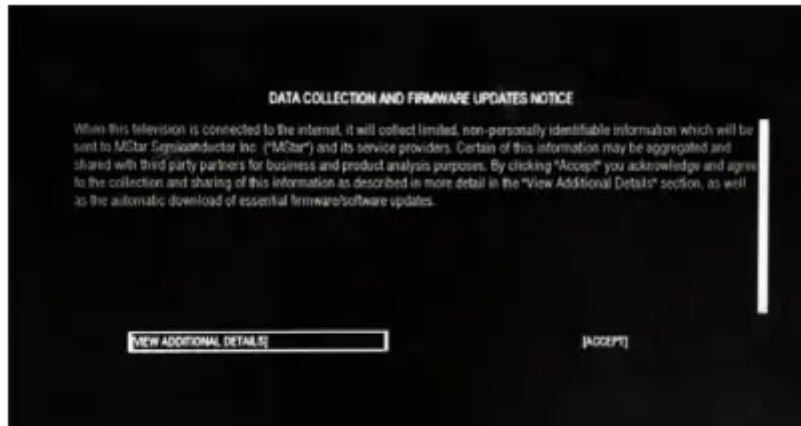

Select Clock

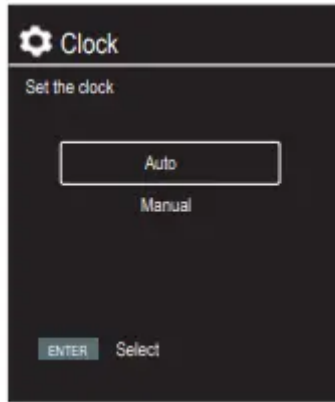

- Press ▼ / ▲ button to select the clock . Press ENTER button to enter the next menu.

Select Home or Retail

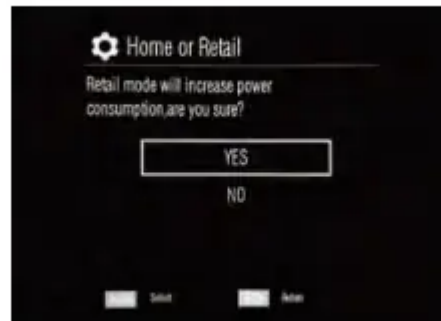

- Set the TV Mode to Home or Retail display use.
- Press ▼ / ▲ button to select(Home Mode / Retail).
- Press ENTER button to enter the sub-menu.

Select Time Zone

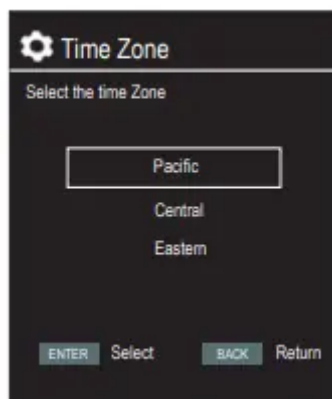

- Press ▼ / ▲ button to select the Time Zone.
- Press ENTER button to enter the next menu.

Select DST

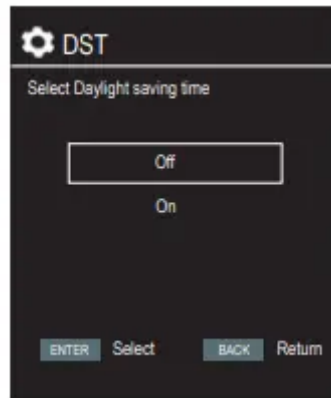

- Press ▼ / ▲ button to select the Select Daylight saving time.
- Press ENTER button to enter the next menu

Select Network Configuration

- Press ▼ / ▲ button to select Network Configuration.
- Select YES to enter the Network Configuration

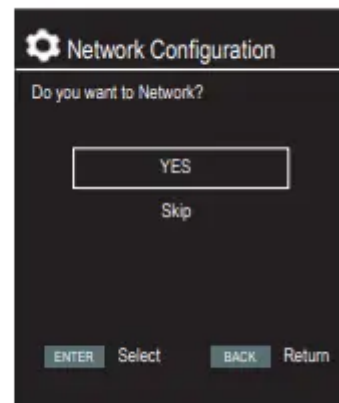

Select Auto Search

- Press ▼ / ▲ button to select Auto Search.
- Slect YES to enter the Auto Search

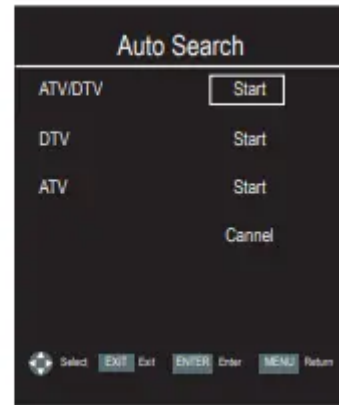
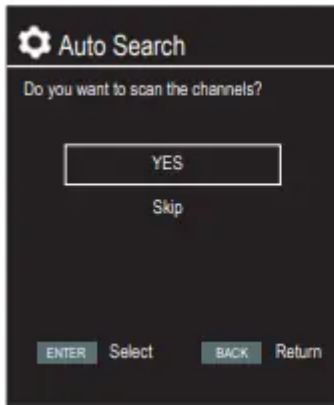

Input Setup

- Press input key on the remote control to enter "INPUT SOURCE" menu. There are these options for you to select: "TV", "AV", "Component", "HDMI1", "HDMI2", "HDMI3", "USB".
- Use ◀ / ▶ key to select a input source and press Enter key to confirm.

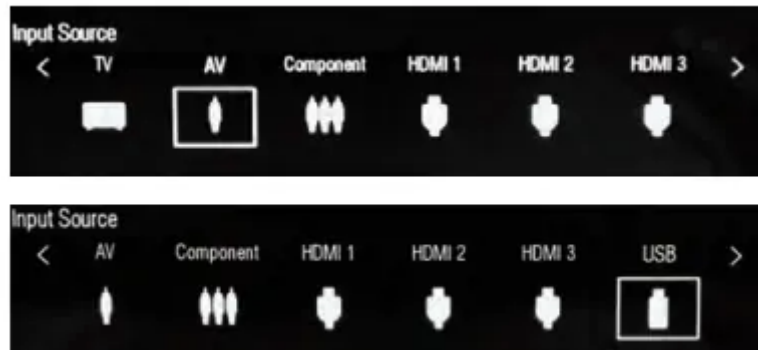

Current Channel Information

- Press "INFO" key on the remote control to view current channel information, the indications of channel information are listed in the following table.

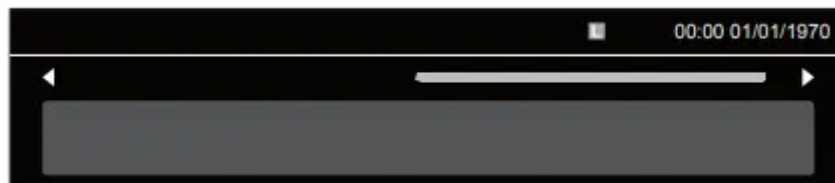

- Press "EXIT" key on the remote control to exit this OSD.

Menu system instruction

Picture

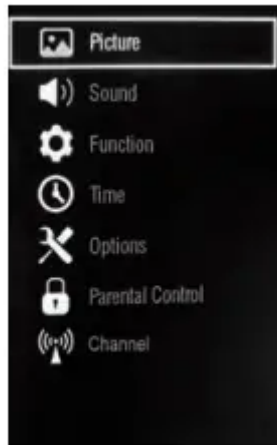

1. Press Menu key to display the main menu on the screen.
2. Press ▲/▼ key to select "Picture" option.
3. Press ► key to enter "Picture" submenu.

Picture Mode: Your TV has four picture settings (Dynamic, Standard, Movie, Game, Power Saving, User) that are preset at the factory. Only "User" mode can be set to your preference by adjusting particular items such as Contrast, Brightness, Color, Sharpness.

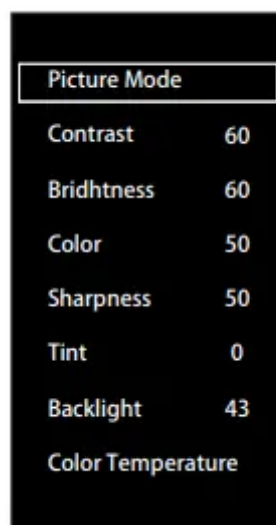

1. Press ▲/▼ key to select "Picture Mode" option.
2. Press ▲/▼ key to select one picture mode.

User settings for PICTURE (Contrast, Brightness, Color, Sharpness, Tint): Your set has several settings which allow you to control picture quality.

1. Press ▲/▼ key to select a particular item.
2. Press ◀ / ▶ key to decrease or increase the value of a particular item. Note: The adjusted values are stored according to the selected particular item.

Contrast: Adjusts the lightness and darkness between objects and the background.

Brightness: Adjusts the brightness of the picture.

Color: Adjusts the colors, making them lighter or darker.

Sharpness: Adjusts the outline of objects to either sharpen them or make them more dull.

Tint: Adjusts the Tint of the picture.

Backlight: You can Change the brightness of the entire screen according to your preference.

1. Press ▲ / ▼ key to select "Backlight" option.
2. Press ◀ / ▶ key to increase or decrease the backlight value.

Backlight: Adjusts the brightness of the whole screen.

Color Temperature: You can change the color of the entire screen according to your preference.

1. Press ▲ / ▼ key to select "Color Temperature" option.
2. Press ◀ / ▶ key to select one color temp.

Cool: Makes whites bluish.

Neutral: Makes whites nature

Warm: Makes whites reddish

Sound

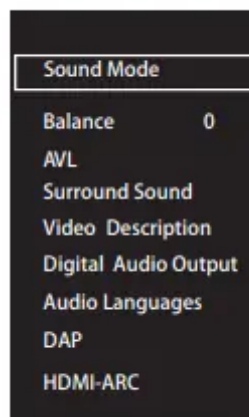

1. Press Menu key to display the main menu on the screen.
2. Press ◀ / ▶ key to select "Sound" option.
3. Press ▶ key to enter "Sound" submenu.

Sound Mode: You can select the type of the special sound effect to be used when watching a given broadcast. Your TV has five sound settings ("Standard", "Music", "Movie", "Sports", "User") that are preset at the factory.

1. Press ◀ / ▶ key to select "Sound Mode" option. Press ENTER or ▶ to enter.

2. Press ◀ / ▶ key to select one sound mode

Standard: Selects the normal sound mode.

Music: Provides clear and live sound for music.

Movie: Provides live and full sound for movies.

Sports: Emphasizes bass over other sounds.

User: Selects your custom sound settings.

Balance: If the volumes of the left speaker and the right speaker are not the same, you can adjust the "Balance" to suit your personal preference.

1. Press ◀ / ▶ key to select "Balance" option.

2. Press ◀ / ▶ key to decrease or increase the value of the item.

AVL: Each broadcasting station has its own signal conditions, and it is inconvenient to adjust the volume every time the channel is changed. "AVL" automatically adjusts the volume of the desired channel by lowering the sound output when the modulation signal is high or by raising the sound output when the modulation signal is low.

1. Press ▲ / ▼ key to select "AVL" option.

2. Press ▲ / ▼ key to select "On" or "Off".

Surround sound: This is used to turn on surround sound to gain better sound effect.

1. Press ▲ / ▼ key to select "Surround sound" option.

2. Press ▲ / ▼ key to select "Surround" or "Off".

Video Description

1. Press ▲ / ▼ key to select "Video Description" option.

2. Press ▲ / ▼ key to select "On" or "Off".

Digital Audio Output: This is used to set digital audio output

1. Press ▲ / ▼ key to select "Digital Audio Output" option.

2. Press ▲ / ▼ key to select "Auto" or "PCM".

Audio Languages : You can set the first and secondary language for audio

DAP: This is used to set DAP.

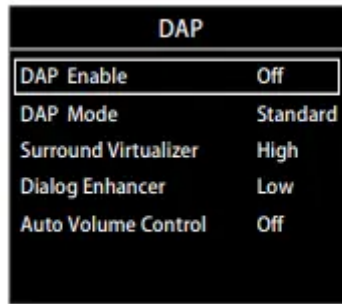

1. Press ▲/▼ key to select "DAP" option.
2. Press ► key to enter "DAP" submenu

HDMI ARC: Turn on or turn off the HDMI ARC function.

Function

1. Press Menu key to display the main menu on the screen.
2. Press ▲/▼ key to select "Function" option.
3. Press ► key to enter "Function" submenu.

Noise Reduction

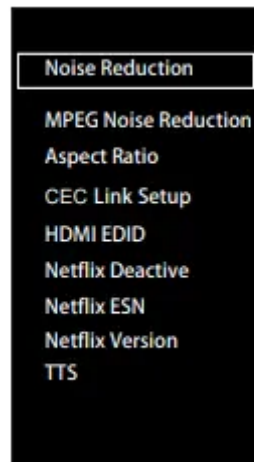

- Press ▲/▼ key to select the Noise Reduction mode. You can select the right mode to match the pictures.

MPEG Noise Reduction

- Press ▲/▼ key to select the mode: off/low/middle/high. The picture will be better when it is in "high" mode.

Aspect Ratio

1. Press ▲/▼ key to select "Aspect Ratio" option.
2. Press ▲/▼ key to change the size of the picture on the size of the picture on the screen.

CEC Link Setup

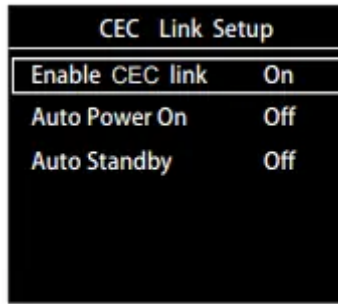

1. Press ▲/▼ key to select “Link Setup” option.
2. Press ENTER or ► key to enter “Link Setup” submenu. Enable Link: Press ◀ / ▶ to turn on/off the link setup. Auto Power On: When this option is “On” and the TV is in standby mode. To turn on the DVD can also turn the TV at the same time. Auto Standby: When this Option is “On” and the TV is on, to turn off TV can also turn the DVD into standby mode.

HDMI EDID: This function is only used in HDMI mode.

1. Press ▲/▼ key to select “ HDMI EDID” option.
2. Press ▲/▼ key to select “ 1.4” or “ 2.0”

The HDMI jacks on your TV are Ultra HD (UHD) jacks. Depending on the HDMI device you connect to the HDMI jack or the streaming content you watch, you may need to adjust the timing

- 1.4: For FHD compatible HDMI device. Supports timing limit on 3840 x 2160@60Hz, YCbCr 420
- 2.0: For UHD compatible HDMI device. Supports timing limit on 3840 x 2160@60Hz, YCbCr 444/422/420

Netflix Deactive

1. Press “ ▲/▼ ” key to select “Netflix Deactive” option.
2. Press “ ► ” or “ENTER” key to confirm.
3. Press “Yes” to confirm again, the Netflix will be activated.

Netflix ESN: Display the Netflix ESN information.

Netflix Version: Display the Netflix version

Time

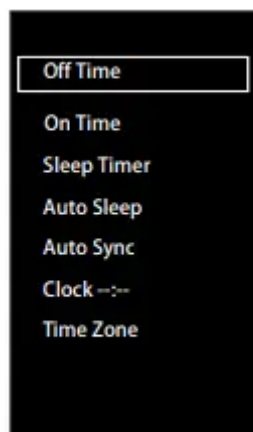

1. Press Menu key to display the main menu on the screen.
2. Press ▲/▼ key to select "Time" option.
3. Press ► key to enter "Time" submenu.

Off Time: In "Off Time" item, press ► button or ENTER button to enter the submenu, set the day & time to turn off the TV set.

On Time: In "On Time" item, press ► button or ENTER button to enter the submenu, set the time to turn on the TV set, when the TV set is in the standby mode. You can also choose which day to control you TV set in a week.

Sleep Timer

1. Press ▲/▼ key to select "Sleep Timer" option.
2. Press ▲/▼ key repeatedly until the desired time appears (Off, 10mins, 20mins, 30mins, 60mins, 90mins, 120mins, 180mins, 240mins).

Notes: The sleep timer you have set will be cancelled when the TV turns off or if a power failure occurs.

Notes: When the time is less than 60 seconds, remind information will be displayed on the screen. Press any key button to cancel timer function.

Auto Sleep: Press ▲/▼ key to select whether to open the Nosignal Power off features. If this function is opened, the TV will power off in ten minutes when there is no signal.

Auto Sync: You can modify the time of your TV set in Manual mode. In Auto mode, the "clock" is decided by the DTV signal.

Clock --:-- : When Auto Sync is on, the clock is got from DTV streams; Set the clock when Auto Sync is off.

Time Zone: You can choose it to modify your time zone in the TV set.

1. Press ▲/▼ key to select "Time Zone" option.
2. Press ▲/▼ key to select time zone.

Options

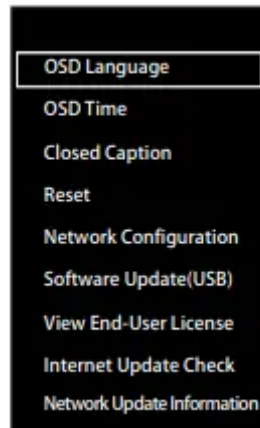

1. Press Menu key to display the main menu on the screen.
2. Press ▲/▼ key to select "Option" option.
3. Press ► key to enter "Option" submenu.

OSD Language .

1. Press ▲/▼ key to select "OSD Language " option.
2. Press ENTER or ► key to select a proper language for OSD.

OSD Time: Set the preferred amount of time for the OSD to be displayed on the screen.

Closed Caption

1. Press ▲/▼ key to select "Closed Caption" option.
2. Press ▲/▼ key to select CC mode.

Reset

1. Press "▲/▼" key to select "Reset" option.
2. Press "►" or "ENTER" key to confirm.
3. Press "Yes" to confirm again, TV will turn off automatically and change all setting to factory setting.

Network Configuration: Please refer to "Network setting" behind. Software Update(USB) When the TV need to be updated, please copy the new software to a USB storage and inset the USB storage to TV, then operating by following steps.

1. Press "▲/▼" key to select "Software Update" option.
2. Press "►" or "ENTER" key to confirm.
3. Press "Yes" to confirm again, the TV will update by USB, Please wait a few minutes and don't turn off the power, it will turn off automatically when updating is finish.

View End-User License: Press "▶" or "ENTER" key to confirm. Internet Update Check This can update TV through internet. Network Update Information Display the Network Update Information .

Parent Control: The "Parent Control" feature automatically locks out programming that is deemed inappropriate for children. The user must first enter a Password before any of the lock restrictions can be set up or changed.

1. Press ▲/▼ key to select "Parent Control" option.
2. Press ENTER or ▶ key to enter "Parent Control" submenu, "Enter Password" menu will appear, enter your 4-digit password to enter "Parent Control" submenu (the default password is 0000 and the universal password is 1470)

Parent Control: Set the Lock function on or off.

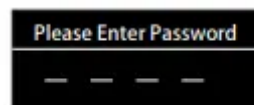

1. Press ▲/▼ key to select "Parent Control" option.
2. Press ▲/▼ key to select "On" or "Off".

Set Password

1. Press ▲/▼ key to select "Set Password" option.
2. Enter your 4-digit password to enter "Set Password" submenu. Choose any 4-digits for your new password and enter them. As soon as the 4 digits are entered, the cursor skipped to "Confirm Password" item, re-enter the same 4 digits, and your new password has been memorized. When the programs is locked, you can also press the menu key, Info key and so on. Then you can press ◀ / ▶ key to call back the input-password window.



USA TV

1. Press ▲/▼ key to select "USA TV" option.
2. Press ENTER key to open USA TV menu.

USA MPAA

1. Press ▲/▼ key to select "USA MPAA" option.
2. Press ENTER key to open USA MPAA menu.

Canada English

1. Press ▲/▼ key to select "Canada English" option.
2. Press ENTER key to open Canada English menu.

Canada French

1. Press ▲/▼ key to select "Canada French" option.
2. Press ENTER key to open Canada French menu.

RRT Setting

1. Press ▲/▼ key to select "RRT Setting" option.
2. Press ENTER key to open RRT Setting menu.

RRT Reset

1. Press ▲/▼ key to select "RRT Reset" option.
2. Press ENTER key to open RRT Reset menu.

Block Unrated TV

1. Press ▲/▼ key to select "Block Unrated TV" option.
2. Press ▲/▼ key to select "On" or "Off".

Channel

Before your television can begin memorizing the available channels, you must specify the type of signal source that is connected to the TV (i.e. an antenna or a cable system).

1. Press Menu key to display the main menu on the screen.
2. Press ▲/▼ key to select "Channel" option.
3. Press ENTER or ► key to enter "Channel" submenu.

Antenna Mode

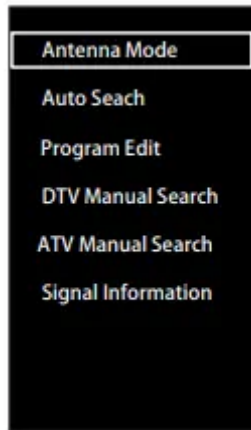

1. Press ▲/▼ key to select "Antenna" option.
2. Press ▲/▼ key to select "Antenna" or "CABLE".

Auto Search

1. Press ▲/▼ key to select "Auto Search" option.
2. Press ► or ENTER key to confirm. then a notice window will be displayed on the screen. Select "Start" to start search or "Cancel" to cancel it. When searching, press EXIT key to exit tuning at any moment. Press Menu key to skip DTV tuning when searching DTV, skip ATV tuning when searching ATV, skip CATV tuning when searching CATV.
3. After all the available channels are stored, the searching menu will exit.

Program Edit : After the program is searched, select "Program Edit" in the "Channel" menu, press "enter" button, program can be edited such as delete or skip according to the user's habit.

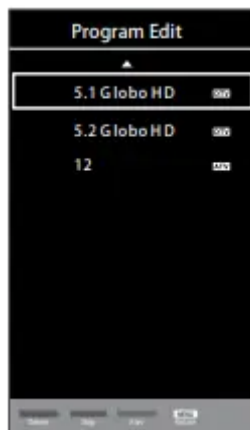

Skip (Blue) Button: This function can help shield certain program. Program skips when selecting program by the "▲/▼" button on the TV or remote control.

1. Select the program to be shielded in the "Program Edit".
2. Press "Skip" (Blue) button, the skip mark is displayed at the left side of the program and this program is shielded.

3. To cancel the Skip function, enter the channel edit menu, select the shielded program and press "Skip" (Blue) button, the skip mark at the left side of the program disappears then program is recovered.

Delete (Red) Button: This function can help delete program.

1. Select the program to be deleted in the "Program Edit".
2. Press "Delete"(Red) button, the program will be deleted.

Favorite(Yellow) button: This function can help store the favorite program then these programs can be quickly selected.

1. Select the program which is favorite.
2. Press "Fav"(Yellow) Button, the favorite mark is displayed at the left side of the program and this program is store into the Favorites.
3. To cancel the Favorite function, enter the program edit menu, select the program and press "Fav"(Yellow) button, the favorite mark at the left side of the program disappears.

DTV Manual Search

- Enter digital number and press "ENTER" to select DTV Channel.

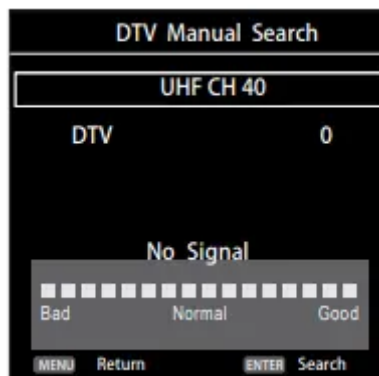

ATV Manual Search

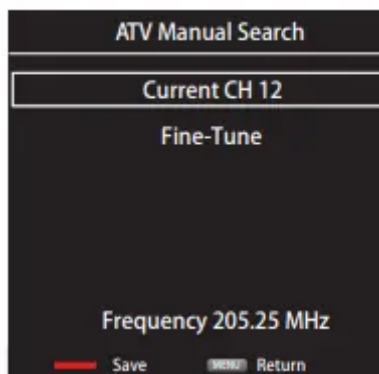

1. Press ▲/▼ key to select "ATV Manual Search" option.
2. Press ► or ENTER key to enter submenu.

Current CH

1. Press ▲/▼ key to select the second item.
2. Press ◀ / ▶ key to select current channel.

Fine-Tune

1. Press ▲/▼ key to select the third item.
2. Press ◀ / ▶ key to select a better frequency for current channel.

Signal Information(Used only in DTV)

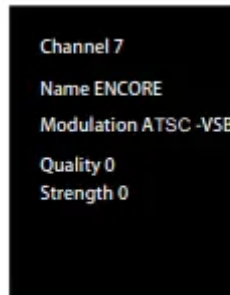

1. Press ▲/▼ key to select "Signal Information" option.
2. Press "ENTER" or ▶ key ,you can see the information of the DTV channel.

Network Setting

1. Press the " Menu " to enter, then pitch on the "Options", and press "ENTER" or click the right button to enter the submenu.

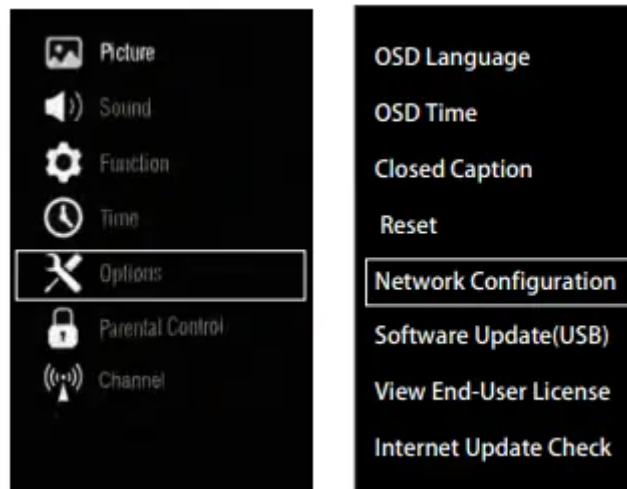

2. Pitch on the "Network Configuration", and press "ENTER" or click right button to enter the "Network Configuration".



3. When the wired network is used, if select dynamic IP address setting, pitch on the "DHCP" in the "Network Configuration", then click the "Setting", and press the "ENTER" button to enter. If select static IP address setting, pitch on the "Static" in the "Network configuration", then setting up the IP, Netmask, Gateway and DNS in sequence. When the setting complete, pitch on the "setting" and press the "Enter".

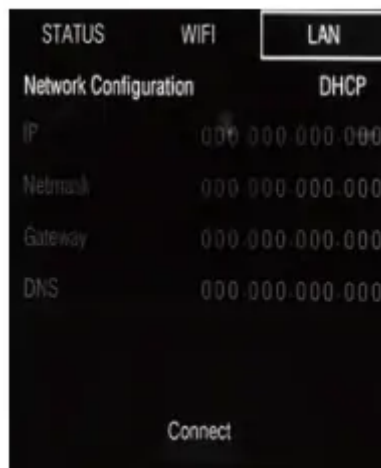

4. If shows "Success" , the "WLAN" on the bottom right corner will turn to green from red, and it means the network connect successfully; If shows "Fail" , it means the network can not connect, please check whether the net wire and router connect successfully or not.

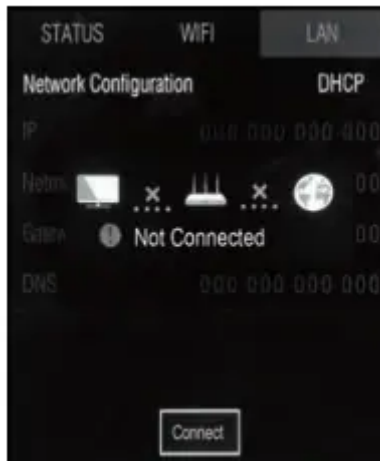

5. Select the "WIFI" in the Network Configuration before using WIFI connecting.

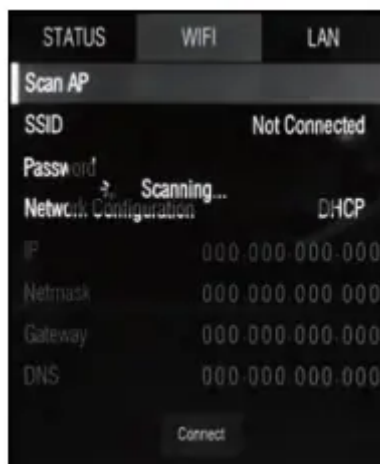

Press on the "Setting" , press the "ENTER" to confirm. If shows "Success" , the "WIFI" on the bottom right corner will turn to green from red, and it means the network connect successfully; If shows "Fail" , it means the network can not connect, please check whether the wireless router connects successfully or not.

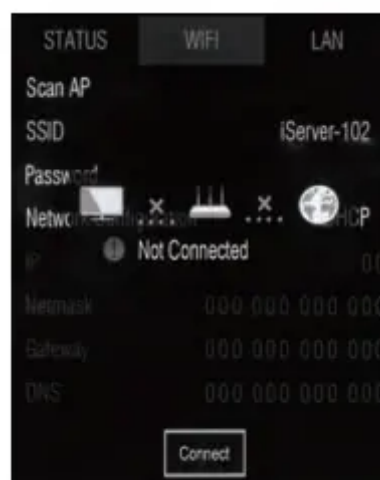

USB Operation

- Note: Before operating USB menu, Plug in USB device, then press INPUT button to set the Input Source to USB .
- Press ◀ / ▶ button to select USB in the Source menu, then press ENTER button to enter.

Picture Menu

- Select Picture in the main menu, then press Enter button to enter.
- Press Exit button to return to the previous menu and exit menu to quit.

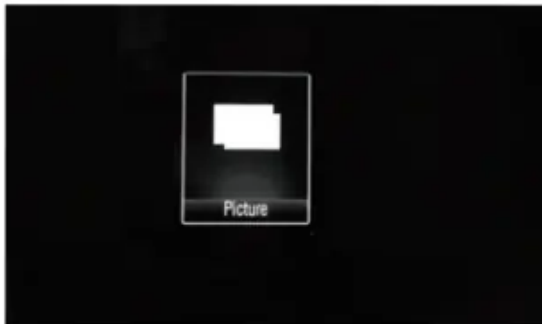

USB version 2.0

Image	Photo	Resolution (width x height)	Remark
JPEG	Base-line	15360x8640 (1920x8 x 1080x8)	The limitation of max resolution depends on DRAM size
	Progressive	1024x768	The limitation of max resolution depends on DRAM size

Troubleshooting

If the device performance fails, check whether the detected problem is in the following table. If your device still fails, contact customer service.

1. TV – No signal input connected, loose or disconnected.

- Signal cable is loose or not connected.
 - Ensure signal cable is not loose or disconnected. Reattach and try again.

2. Remote Control - Distance is short, no control.

- Receiver of remote control is covered.
 - Ensure the remote receiver is not obstructed.
- The battery energy of the remote control is too low.
 - Change the batteries.



3. TV - Display is faint

- Adjustment is incorrect.
 - Use auto-adjustment function.
- Display mode is incorrect.
 - Use recommended mode.

4. TV - Display image does not fill the screen

- Adjustment is incorrect.
 - Use auto-adjustment function.
 - Enter PICTURE to adjust the horizontal and vertical position.
- Display mode is incorrect
 - Use recommended mode.

5. TV - Unable to operate the TV

- Exterior influence, for example lighting, static electricity and so on, which might disturb the normal operation of the TV.
 - Press the  button to turn off electrical source, then press the  button to turn on the TV again after 1-2 minutes.

6. Static and sound noise.

- Antenna cable connector is loose, cable is damaged.
 - Check the antenna cable connector plug for secure connection and any damage.
- Antenna cable type is not correct.
 - Check antenna cable type (VHF/ UHF).
- Direction or position of antenna is incorrect.
 - Adjust the direction or position of antenna.
- Signal is weak.
 - Attempt to use signal amplifier.

7. TV image is better, but has noise .

- Antenna cable connector is loose, cable is damaged.
 - Check the antenna cable connector plug for secure connection and any damage.

8. No image. No sound

- Power plug is loose, power cord does not connect well.
 - Check to ensure power cord is connected.
 - Press POWER on panel or remote control.
 - Check if the  button is on.

9. TV image has stripes

- Signal is exposed to interference, such as a car, neon light, electric blower, etc.
 - Do not use an electric blower around unit.
 - Adjust antenna cable direction to reduce interference.

10. TV image has shadows.

- TV signal is reflected by valley or building.
 - Use a high-directional antenna.
- Direction of antenna is incorrect.
 - Adjust direction of the antenna

11. TV has no sound.

- Volume setting is too low.
 - Adjust volume to proper level.
- Sound is muted.
 - Press MUTE to deactivate mute.

CAUTION: Do not allow your TV screen to display the same image for an extended period of time. Please set up a screen protection procedure. If a high-contrast picture remains on the TV screen for a long time, this picture could burn the image onto the screen. Usually the burnt image will disappear gradually when you turn off the TV's power. However, this damage cannot be repaired.

Specifications

Model	43T7U
TV System	NTSC
Resolution	3840x2160
Wireless LAN	IEEE 802.11b/g/n 2.4-2.5 GHz ISM Band
Power Consumption	85W
Power Supply	AC 100-120V~50/60Hz
Connectivity	HDMI input x 3 RF Antenna Input YPbPr/AV AUDIO IN RJ45 Headphones Output OPTICAL Output

Model	49T7U
TV System	NTSC
Resolution	3840x2160
Wireless LAN	IEEE 802.11b/g/n 2.4-2.5 GHz ISM Band
Power Consumption	138W
Power Supply	AC 100-120V~50/60Hz
Connectivity	HDMI input x 3 RF Antenna Input YPbPr/AV AUDIO IN RJ45 Headphones Output OPTICAL Output

Model	50T7U
TV System	NTSC
Resolution	3840x2160
Wireless LAN	IEEE 802.11b/g/n 2.4-2.5 GHz ISM Band
Power Consumption	138W
Power Supply	AC 100-120V~50/60Hz
Connectivity	HDMI input x 3 RF Antenna Input YPbPr/AV AUDIO IN RJ45 Headphones Output OPTICAL Output

Model	55T7U
TV System	NTSC
Resolution	3840x2160
Wireless LAN	IEEE 802.11b/g/n 2.4-2.5 GHz ISM Band
Power Consumption	168W
Power Supply	AC 100-120V~50/60Hz
Connectivity	HDMI input x 3 RF Antenna Input YPbPr/AV AUDIO IN RJ45 Headphones Output OPTICAL Output

Remote Control

Signal Type	Infrared
Control Distance	8 meters
Control Angle	30° (Horizontal)
Power Supply	AAA 1.5V x 2

Warning

This content is compiled from multiple sources and is provided for reference purposes only. It may not be complete or fully applicable to all situations. If you are unable to resolve your issue, please contact the product manufacturer or an authorized service provider for official support.

