

## Overview of your washer

Make sure all the parts are included in the product package. If you have a problem with the washer or the parts, contact a local Samsung customer center or the retailer.

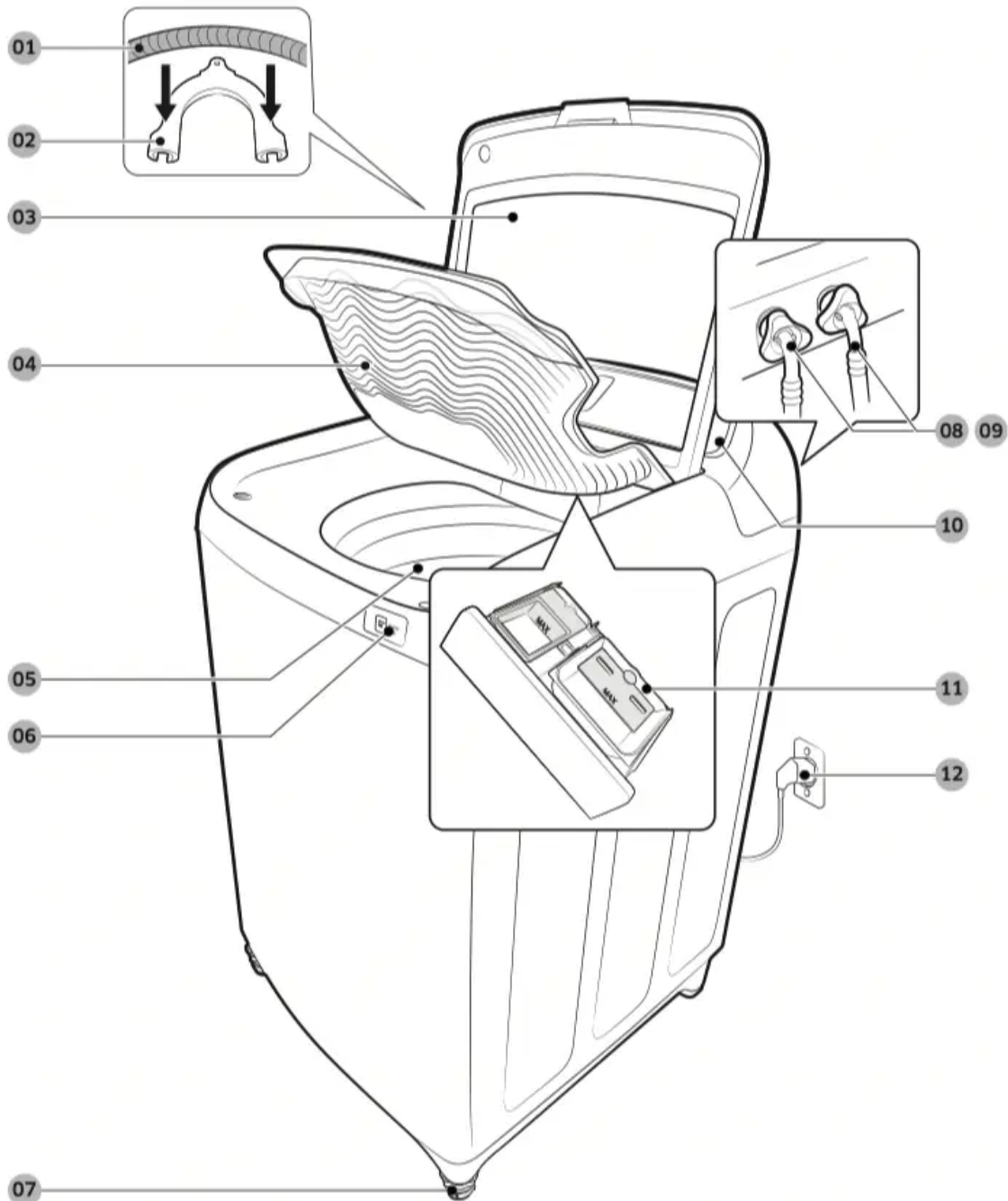

01 Drain hose

02 Hose guide



- 03 Lid
- 04 Built-in sink
- 05 Tub
- 06 Water Jet
- 07 Leveling feet
- 08 Water hose (Cold)
- 09 Water hose (Hot)
- 10 Control panel
- 11 Detergent drawer
- 12 Power cord

## Operating instructions

### WARNING

To reduce the risk of fire, electric shock, or injury to persons when using your appliance, follow basic precautions, including the following:

### Loading your washer

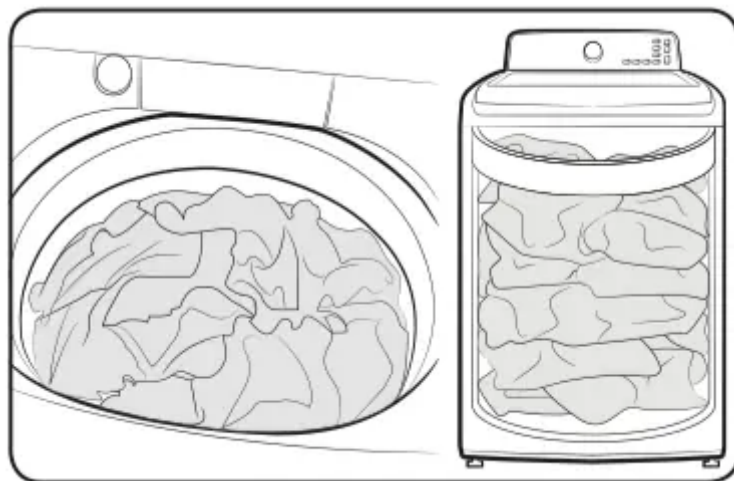

- Fill the tub with dry, unfolded clothes evenly around in order to enhance washing efficiency and prevent excess wear, or wrinkling of the load.
- For optimal washing performance, make sure the laundry is piled up evenly.
- Wash delicate items such as bras, hosiery, and other lingerie in the Delicates cycle with similar lightweight items.

- When washing big bulky items or a few smaller items that don't fill the tub completely – a rug, a pillow, stuffed toys, or one or two sweaters, for example – add a few towels to improve spin performance.
- Do not insert bulky items except for Bedding in this cycle.

**NOTE**

During the spin cycle, the washer may add additional water to redistribute the clothes and correct an imbalance inside the drum.

- When washing heavily soiled loads, do not overload your washer to ensure good cleaning results.

**CAUTION**

- Inflatable items may cause damage to the laundry or the machine during the wash or drying process.
- Regardless of the size, blankets or quilts are safer and cleaner to wash one item at a time. Two different-sized blankets in the same load may compromise the drying performance due to unbalanced loads.

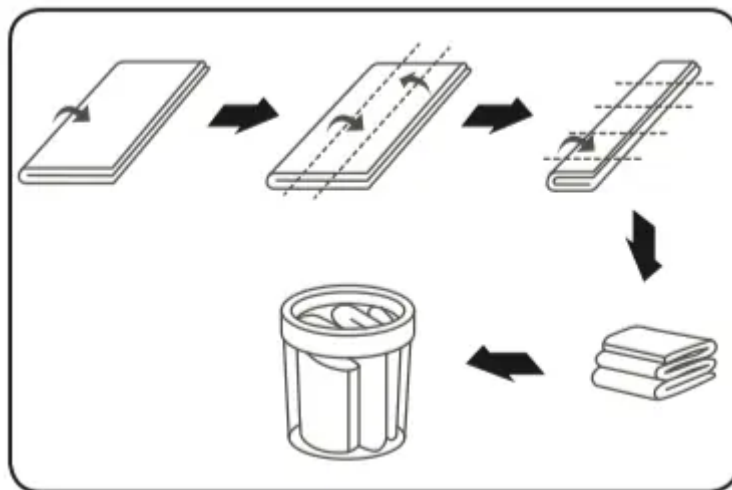

**To input a blanket**

Fold the blanket into the blanket-specific net as shown, and then insert in the tub below the plastic area of the tub.

**CAUTION**

Make sure the laundry is inserted completely.

- Any exposed part of the laundry may cause damage to the machine or the laundry itself, or a water leak.
- Do not overload the tub. Make sure no part of the laundry is exposed outside of the tub.

**To add a forgotten item:**



1. Press Start/Pause to pause the washer.
2. Wait for the door to unlock automatically, and then open the door.
3. Add the item, close the door, and then press Start/Pause. The cycle will resume.

## Getting started

1. Load your washer.
2. Add liquid (or powder) detergent and additives to the dispenser (see the "Detergent use" section on page 42).
3. Select the appropriate cycle and options for the load (see the "Washing a load of laundry" section page 30).
4. Close the lid.
5. Press Start/Pause.
6. The Wash Indicator illuminates.
7. The estimated cycle time will appear in the display. The time may fluctuate to indicate the time remaining in the cycle.

### NOTE

The actual time required for a cycle may differ from the estimated time in the display depending on the water pressure, water temperature, detergent, and laundry.

8. Before your washer starts to fill, it will make a series of clicking noises to check the door lock and do a quick drain.

### NOTE

- When the cycle is complete, the  Door Lock indicator will go out and "End" will appear in the display.
- Pressing Power cancels the cycle and stops your washer.
- The Wash, Rinse, and Spin indicators will illuminate during those portions of the cycle.

## Washing a load of laundry

### WARNING

To reduce the risk of fire, electric shock, or injury to persons, read the IMPORTANT SAFETY INSTRUCTIONS before operating this appliance.

# Control panel

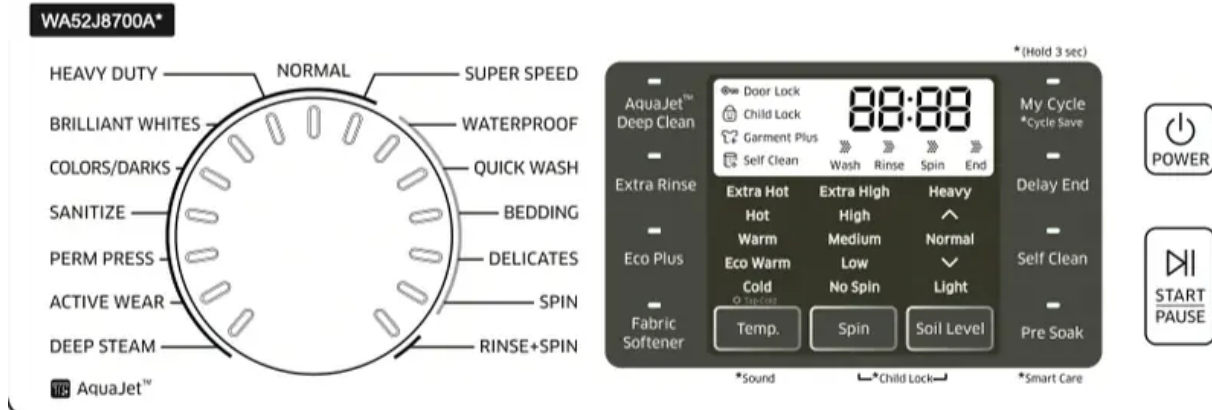

<b>01 Cycle Selector</b>	Turn the Cycle Selector to select the desired cycle. The indicator by the cycle name lights up.
<b>02 Display</b>	Provides instructions and diagnostics while keeping you updated on the cycle status and time remaining.
<b>04 Spin</b>	<p>Press the button repeatedly to cycle through the different spin speed options.</p> <ul style="list-style-type: none"> <li>• Extra High - Removes more water from loads during spin.</li> <li>• High - Use for underwear, t-shirts, jeans, and sturdy cottons.</li> <li>• Medium - Use for jeans, wrinkle-free or wash-and-wear items, and synthetics.</li> <li>• Low - Use for delicate items needing a slow spin speed.</li> <li>• No Spin - Drains your washer without spinning. Use for extremely delicate items that cannot tolerate any spin.</li> </ul>
<b>05 Soil Level</b>	<p>Press the button to select the soil level/washing time. (Light &gt; ▼ &gt; Normal &gt; ▲ &gt; Heavy)</p> <ul style="list-style-type: none"> <li>• Heavy - For heavily soiled loads.</li> <li>• ▲</li> <li>• Normal - For moderately soiled loads. This setting is best for most loads.</li> <li>• ▼</li> <li>• Light - For lightly soiled loads.</li> </ul>
<b>06 AquaJet™ Deep Clean</b>	Improve washing performance through longer AquaJet spray action. Water Level can be adjusted.
<b>07 Extra Rinse</b>	Change from spray rinse mode to deep rinse mode, and rinse once again.
<b>08 Eco Plus</b>	To increase your energy savings on your wash cycles. (Less hot water consumption)



<b>09 Fabric Softener</b>	Add an additional rinse at the end of the cycle to more thoroughly remove laundry additives and perfumes.
<b>10 My Cycle</b>	Press and hold for 3 seconds to save your own cycle.  Create and/or use a cycle you have customized temperature, spin speed, soil level, options, etc.
<b>11 Delay End</b>	Delay the end of any cycle for up to 19 hours in one-hour increments. Displayed hour indicates the time the wash will be ended.
<b>12 Self Clean</b>	Use to clean dirt and bacteria from the drum. Regular use (after every 20 washes) is recommended. No detergent or bleach is needed.
<b>13 Pre Soak</b>	It adds 15 minutes soaking time at the start of the wash cycle for better stain removal.
<b>14 Power</b>	Press once to turn your washer on. Press again to turn your washer off. If the washer is left on for more than 10 minutes without any buttons being pressed, the power automatically turns off.
<b>15 Start/ Pause</b>	Press to pause and restart cycles.

## Cycle overview

### NOTE

To minimize wrinkling of laundry, select Perm Press.

Cycle	Description
<b>NORMAL</b>	For most fabrics including cottons, linens, and normally soiled garments.
<b>SUPER SPEED</b>	Lightly soiled and Normal Loads (up to 8lb).
<b>BRILLIANT WHITES</b>	For white fabrics with or without bleach.
<b>COLORS/DARKS</b>	For brightly or dark colored casual garments.
<b>HEAVY DUTY</b>	For sturdy, colorfast fabrics and heavily soiled garments. We propose to use this function only when washing lot of heavily soiled garments.
<b>ACTIVE WEAR</b>	Use this cycle to wash exercise wear such as sports jerseys, training pants, shirts/tops and other performance clothing. This cycle provides effective soil removal with gentle action for special fabric care.
<b>PERM PRESS</b>	For wash-and-wear, synthetic fabrics, and lightly to normally soiled garments.
<b>DEEP STEAM (WA52J8700A*)</b>	For heavily soiled, colorfast garments, this cycle provides a high washing temperature and steam and is effective for cleaning stains.
<b>SANITIZE (WA52J8700A*)</b>	<p>For heavily soiled, colorfast garments. (less than 14lbs)</p> <p><b>NOTE</b></p> <p>If you select pause during the heating portion of the Sanitize Cycle, your Washer door will remain locked for your safety.</p>
<b>WATERPROOF</b>	<p>For waterproof or water-resistant items. (less than 14lbs)</p> <p><b>CAUTION</b></p> <p>※ Do not wash waterproof items and non-waterproof items together.</p> <p>※ Check the specification label on the fabric item and see if the item is waterproof. Do not wash non-waterproof items with the WATERPROOF cycle.</p>



<b>QUICK WASH</b>	For lightly soiled garments needed quickly.
<b>BEDDING</b>	<p>For bulky and large items, such as comforters, blankets and sheets.</p> <p>When washing comforters, use liquid detergent. Waterproof sheets and all water resistant items should be washed using the waterproof cycle.</p> <p><b>CAUTION</b></p> <p>※ Use the waterproof cycle for waterproof or water-resistant items such as mattress covers, plastic mats, bath mats, ski pants, raincoat and comforters which hardly absorb water.</p>
<b>DELICATES</b>	For sheer fabrics, bras, lingerie, silks, and other handwash-only fabrics. For best results, use liquid detergent.
<b>SPIN</b>	Drains the water and spins at a high speed.
<b>RINSE + SPIN</b>	Use for loads that need rinsing only or to add rinse-added fabric softener to a load.

## Options

### Child Lock

Child Lock prevents children from playing with your washer.

#### Activating the Child Lock function

Press and hold Spin and Soil Level simultaneously for approximately 3 seconds.

- When you activate the Child Lock function, the Child Lock  indicator blinks. Using the Child Lock function If the lid is opened when the Child Lock function is on, “dC” is displayed and an alarm sounds.
- If the water level in the tub is above the safe water level, “dC” is displayed on the LED display and the washer starts to drain water by force after 30 seconds.
- If the water level in the tub is above the safe water level and the Child Lock function is turned on while the door is open, “CL” is displayed on the LED display even if the power of the washer is turned off and the washer drains water by force.
- Even if the power of the washer is turned off, if the lid is opened while the water level in the tub is above the Reset water level, “CL” is displayed on the LED display without the alarm sounding and the washer starts to drain water. When the draining operation finishes, the power is automatically turned off again.

- You have activated the Child Lock function while the washer is running, the Start/Pause button will not work.
- After the compulsory drain, the “CL” blinks at 1 second intervals and the product enters the “CL” mode. (When the product is in the “CL” mode, only the Power button works.)
- To cancel the “CL” mode, you need to turn the power off and then on again.
- To cancel the “dC” mode, deactivate the Child Lock function. To deactivate the Child Lock function, press and hold Spin and Soil Level simultaneously for at least 3 seconds.

## NOTE

Adding laundry when Child Lock is on To add laundry, deactivate the Child Lock function. To deactivate the Child Lock function, press and hold Spin and Soil Level simultaneously for at least 3 seconds. See the “Pause Option” section on page 38 for additional details.

## Deactivating the Child Lock function

Press and hold both Spin and Soil Level simultaneously for approximately 3 seconds.

- When you deactivate the Child Lock function, the  Child Lock indicator is turned off.
- The Child Lock function prevents children or the infirm from accidentally operating the washer and injuring themselves.

## WARNING

If a child enters the washer, the child may become trapped and suffocate.

## CAUTION

- Once you have activated the Child Lock function, it continues working even if the power is turned off.
- Forcing the lid open can result in injury or damage to the product.

## NOTE

To add laundry after you have activated the Child Lock function, you must first deactivate the Child Lock function.

## Sound

The Sound Off function can be selected during all cycles.

## Garment Plus

You can add or take out laundry items even after the wash has started, as long as the  Garment Plus indicator is on. Pressing Start/Pause unlocks the lid. If you open the lid and want to continue the wash cycle, close the lid, and then press Start/Pause.

## NOTE

If you have activated the Child Lock, you must deactivate it first. See page 34.

## **My Cycle**

Lets you save a custom wash cycle (temperature, spin, soil level, etc.) and then recall and use it with one button convenience.

To save a cycle and selected options as your My Cycle, follow these steps:

1. Press Power.
2. Select a cycle using the Cycle Selector.
3. After cycle selection, set each option.

### **NOTE**

See the “Cycle chart” section on page 63 for available option settings with each cycle.

4. You can then store the selected cycle and options by pressing and holding My Cycle for longer than 3 seconds. The cycle and options you select will be displayed the next time you choose the My Cycle function.
5. Press My Cycle to load and use the saved My Cycle options. The “My Cycle” light will indicate activation. Also, the chosen cycle and option lights will flicker.

### **NOTE**

You can change the My Cycle settings by repeating the process above.

The last saved settings will be displayed the next time you choose the My Cycle function.

### **NOTE**

If you press My Cycle and release it within 3 seconds, the previously saved cycle and options appear. If you press and hold My Cycle for 3 second or longer, the currently set cycle and options are saved and the LED blinks for 3 seconds.

## **Delay End**

You can set the washer to start your wash automatically at a later time, by choosing a delay time.

The hour displayed indicates the time at which the wash will be ended.

1. Set your wash cycle.
2. Press Delay End repeatedly until the delay time is set.
3. Press Start/Pause. The “Delay End” indicator will be lit, and the clock will begin counting down until it reaches the set time.
4. To cancel a Delay End function, press the Power button and then turn the washer on again.

## **Pre Soak**

Use this function when the laundry is heavily contaminated or stained. This function improves the wash performance by adding a Pre Soak cycle.

- If you select this function, the total cycle time is increased by 15 minutes.
- When the Pre Soak cycle starts, the washer repeats a wash cycle after supplying water and then performs a 15-minute soak cycle.
- When the Pre Soak cycle is complete, the configured wash cycle starts without draining water.

**AquaJet™**

With a strong spray and soapy water recirculated by the AquaJet™ pump, laundry can be more gently and thoroughly cleaned than in conventional Top Loads.

- AquaJet™ Deep Clean: If AquaJet™ Deep Clean is selected, washing performance can be further improved by the additional spray action. Sufficient water quantity can be ensured by adjusting the water level.

Cycles	AquaJet™ Deep Clean
NORMAL, SUPER SPEED, BRILLIANT WHITES, COLORS/ DARKS, HEAVY DUTY, SANITIZE (WA52J8700A*), DEEP STEAM (WA52J8700A*), ACTIVE WEAR, PERM PRESS, RINSE+SPIN	Available
WATERPROOF, QUICK WASH, BEDDING, DELICATES, SPIN	Not available

**Eco Plus**

This function sets the temperature somewhat lower than the typical washing cycle and extends the wash time slightly. With laundry time slightly extended, it's possible to keep the same level of washing performance with cooler water. This function reduces energy consumption and maintains the quality of the wash.

**Mist Shower**

Mist Shower sprays water from a nozzle that is independent of the main water supply system. It states that it soaks the laundry with water from the beginning of the rinse cycle and ensures an effective wash, but it's not part of the wash cycle, it's part of the rinse cycle, so this needs to state that it ensures an effective rinse.

(The Mist Shower function may not work if there is too large of a load in the machine.)

**Smart Care**



This function enables you to check the status of the washer using a smartphone.

1. To enable the Smart Care function, press and hold Pre Soak for 3 seconds after turning the power on or when an error occurs.

#### **NOTE**

The error code history is deleted after you use this function.

2. The Smart Care indicator is lit on the display.

3. Run the Smart Care app on your smart phone.

- Android: Galaxy S series, Galaxy Note series. (Other devices may not be normal operation).

Supported OS : Android 2.2 or higher

- iOS: iPhone series

Supported OS : iOS 4.3 or higher

4. Focus your smart phone's camera on the display panel of the washer.

5. If the smart phone's camera is focused on the display panel of the washer, the panel and error message is automatically recognized and the error type and countermeasures are displayed on the smart phone.

6. If the smartphone fails to recognize the error code more than twice, please enter the error code displayed on the display panel of the washer manually into the Smart Care app.

#### **NOTE**

##### **Downloading the Smart Care app**

- Download the Samsung Laundry App into your mobile phone from the Android market or Apple App store. (Search word : Samsung Smart Washer/ Dryer)

#### **NOTE**

##### **Precautions when using Smart Care**

- If light from a light bulb, fluorescent bulb, or lamp is reflected on the display panel of the washer, the smartphone may not be able to recognize the panel or error message easily.
- If you hold the smartphone at too large an angle relative to the front of the display panel, it may not be able to recognize the error code. For best results, hold the smartphone so that the front of the panel and the smartphone are parallel or nearly parallel.

##### **Washing clothes using the cycle selector**

Your new washer makes washing clothes easy, using Samsung's "Fuzzy Control" automatic control system. When you select a wash program, the machine will set the correct temperature, washing time, and washing speed.

1. Press Power.
2. Open the lid.
3. Load the articles of clothing one at a time loosely into the drum, without overfilling it.
4. Add liquid (or powder) detergent, softener, and/or bleach (if necessary) to the appropriate compartments. See the "Detergent use" section on page 39.
5. Close the lid.
6. Use the Cycle Selector to select the appropriate cycle according to the type of material: NORMAL, HEAVY DUTY, SANITIZE (WA52J8700A\*), DEEP STEAM (WA52J8700A\*), COLORS/DARKS, PERM PRESS, ACTIVE WEAR, SUPER SPEED, BRILLIANT WHITE, WATERPROOF, BEDDING, QUICK WASH, DELICATES, SPIN, and RINSE+SPIN. The relevant indicators will illuminate on the control panel.
7. At this time, you can control the wash temperature, the number of rinse cycles, the spinning speed, and the delay time by pressing the appropriate option button.
8. Press Start/Pause and the wash will begin. The process indicator will light up and the remaining time for the cycle will appear in the display.

### **Pause Option**

To remove or add laundry items, follow these steps:

1. Press Start/Pause to unlock the lid.

### **NOTE**

The lid cannot be opened when the water is too HOT.

2. Remove or add laundry items.
3. Close the lid, and then press Start/Pause to restart the wash.

### **NOTE**

If you have Child Lock on, you must deactivate it first. See page 34.

### **When the cycle is finished:**

After the total cycle has finished, the power will turn off automatically.

1. Open the lid.
2. Remove laundry.

### **ATC (Auto Temperature Control)**

ATC is the control function that the washer controls water temperature with temperature sensor (thermistor).

### **NOTE**

Because there are numerous water temperatures depending on the customer's environments (cold areas, warm areas, various water temperatures, settings of heater temperature, etc.), ATC function in our washer maintains the certain level of wash temperature to output the best washing performance at each cycle.

**NOTE**

If you select NORMAL cycle, this cycle is the regulation and UL cycle. Since new washers must reduce the amount of energy usage as a first priority, customers will notice more cold water entering the washer. But, this is normal, not a problem.

In those regulation cycles, Hot temperature is similar to acceptable adult bath-water temperature and warm temperature is similar to comfortable swimming-pool water temperature.

**NOTE**

If customers want to wash clothes in specific water temperatures, customers should choose a different cycle at each temperature (Hot/Warm/Eco Warm).

**The basics (WA52J8700A\*)**

**Prewash (Water Jet & Built-in sink)**



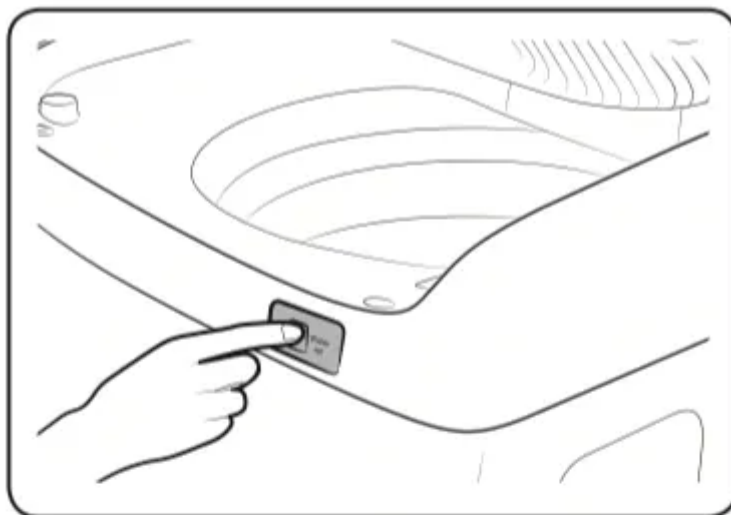

Water Jet and Built-in sink help you handwash before the washing machine starts operation. Water Jet is available only when the door is open with the water level set to less than High. For prewashing, use the Built-in sink that is designed to facilitate the hand-wash.

1. With the door open, lower the Built-in sink . To open only the door, press and release the front right corner of the door. To close and lock both the door and the Built-in sink, press down the door until you hear a clicking sound.
2. Put clothes to prewash in it.
3. Press Water Jet to supply water to the Built-in sink, and hand-wash.

4. When done, gently lift up the Built-in sink to drain water into the tub.

#### **NOTE**

- If you want to hand-wash while the machine is operating, press Start/Pause to stop operation, and then follow steps 1-4 above.
- If you open both the door and the Built-in sink, lower the Built-in sink manually for prewashing.

#### [Water Jet stops]

- Water Jet stops operation automatically when the washing machine detects the maximum water level.
- Water Jet stops operation automatically 5 minutes after it begins. To add more water, press Water Jet again to resupply water.

#### [Water Jet drains]

- Select a cycle and press Start/Pause. Then the washing machine drains the water to be used during the prewash.
- When the washing machine is turned off before starting the wash cycle, it drains the water to be used during the prewash. However, when it is turned off during the wash cycle, it does not drain the water.

#### **NOTE**

- Water Jet extracts the water through the Mist Shower nozzle for 1 second and then through the Water Jet nozzle from then on when it is first activated after the washing machine turns on.

#### **CAUTION**

- Do not abuse Water Jet. Excessive use of Water Jet increases water consumption.
- When running water to the tub, do that gently. Otherwise, water may overflow the tub.
- Use caution when removing laundry from the tub. You may bump your head on the Built-in sink.
- Do not block the outlet of Water Jet with hands. Water may leak outside the tub, causing a system failure.
- Put only clothes to prewash in the Built-in sink. Other items such as shoes, food, or animals can not be used for prewash.
- Do not open the Built-in sink in a hurry. Remaining water in the sink may splash on the door or control panel.
- Due to a difference in air pressure, Water Jet may splash water from its outlet when it is first activated.

- This lid must be closed tightly to do the laundry.

## Detergent use



Your washer is designed to use high efficiency (HE) detergents.

- For the best cleaning results, use a high efficiency detergent such as Tide HE, Wisk HE, Cheer HE or Gain HE\*. High efficiency detergents contain suds suppressors that reduce or eliminate suds. When fewer suds are produced, the load tumbles more efficiently and cleaning is maximized. (\* Brand names are trademarks of their respective manufacturers.)

### WARNING

Regular detergent is not recommended. Use HE detergents only.

### NOTE

Reducing the amount of detergent may reduce the quality of cleaning. It is important to pre-treat stains, sort carefully by color and soil level, and avoid overloading.

## Features

### Automatic dispenser

Your washer has separate compartments for dispensing detergent and color-safe bleach and fabric softener. Add all laundry additives to their respective compartments before starting your washer.

The automatic dispenser must always be in place before you start your washer.

DO NOT open the automatic dispenser when your washer is running.

### NOTE

- Never exceed the manufacturer's recommendations when adding detergent.
- This compartment holds liquid detergent for the main wash cycle, which is added to the load at the beginning of the cycle.
- When using powdered detergent, remove the liquid detergent compartment from the detergent drawer. The washer will not dispense powdered detergent from the liquid detergent compartment.

**To add detergent to the automatic dispenser:**

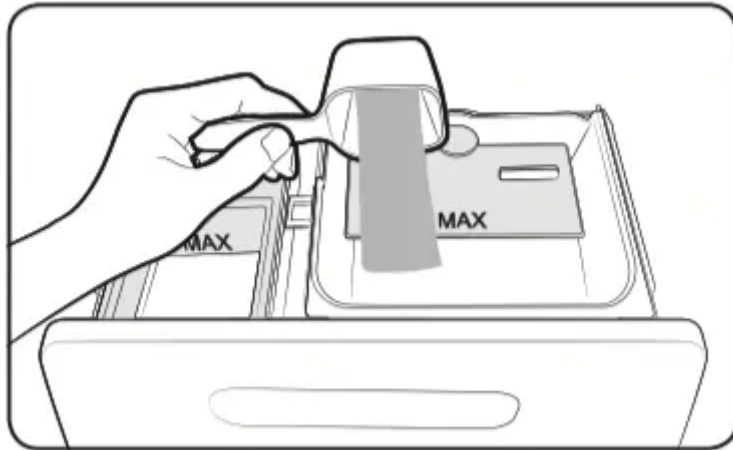

1. Open the dispenser drawer.
2. Load the recommended amount of liquid (or powder) detergent into the detergent compartment before you start your wash.
3. Close the drawer slowly and smoothly to avoid spilling, splashing, or premature dispensing of the contents.

**NOTE**

It is normal for a small amount of water to remain in the dispenser compartments at the end of the cycle.

**NOTE**

Do not put chlorine bleach in the dispenser drawer.

**Loading the Liquid (or Powder) detergent compartment**

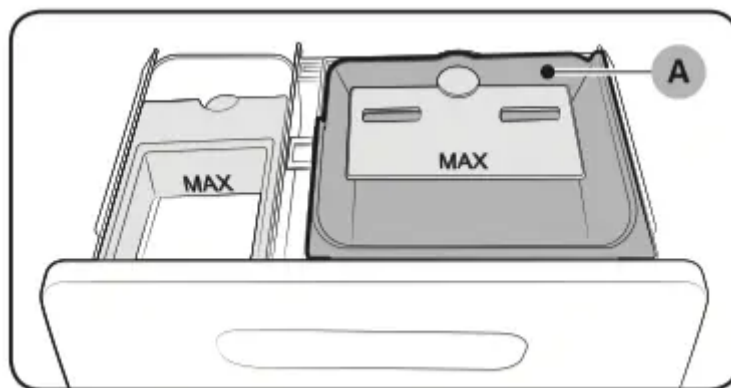

1. Pour the recommended amount of laundry detergent directly into the detergent compartment before starting your washer.
2. If you are using color-safe bleach, add it with the detergent to the detergent compartment.

**NOTE**

When adding color-safe bleach with detergent, it is best if both laundry products are in the same form – liquid.

## NOTE

When using powdered detergent, remove the liquid detergent compartment (A) from the detergent drawer. The washer will not dispense powdered detergent from the liquid detergent compartment.

### Loading the Bleach compartment (WA52J8060A\*)

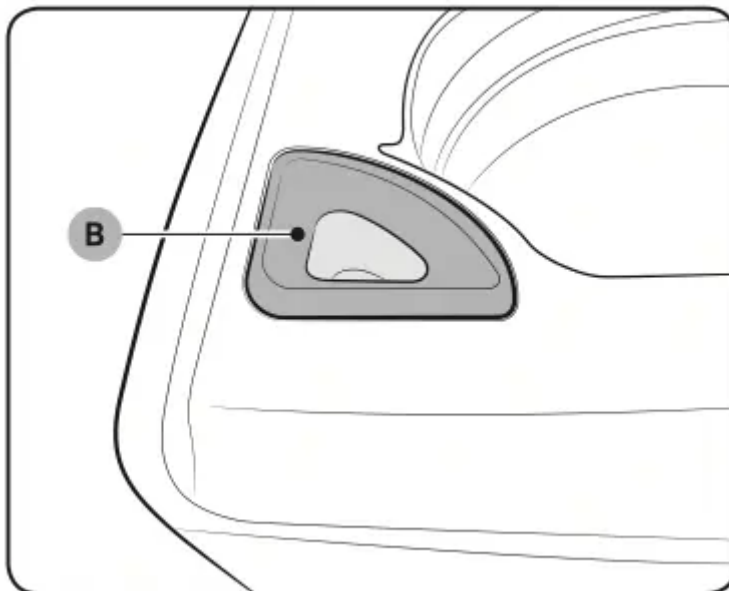

## CAUTION

Use the liquid chlorine bleach only.

1. Add chlorine bleach to the bleach compartment (B). DO NOT exceed the MAX FILL line.

## NOTE

- Avoid splashing or over-filling the compartment.
  - Your washer automatically dispenses bleach into the tub at the appropriate time.
2. The dispenser automatically dilutes liquid chlorine bleach before it reaches the wash load.
- Never pour undiluted liquid chlorine bleach directly onto the load or into the tub. It is a powerful chemical and can cause fabric damage, such as weakening of the fibers or color loss, if not used properly.
  - If you prefer to use color-safe, non-chlorine bleach, add it to the appropriate detergent compartment. DO NOT pour color-safe bleach into the Bleach compartment.

### Loading the Bleach compartment (WA52J8700A\*)

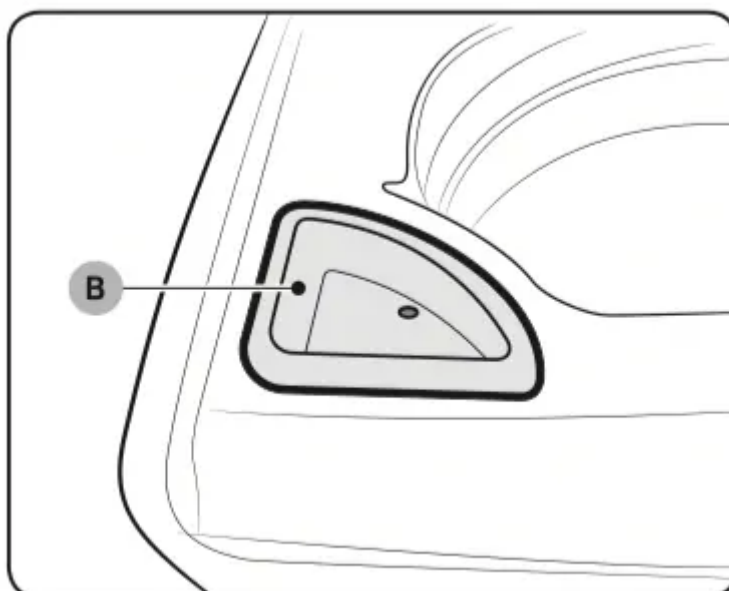

### CAUTION

Use the liquid chlorine bleach only.

1. Add chlorine bleach to the bleach compartment (B). DO NOT exceed the bleach compartment.

### NOTE

- Avoid splashing or over-filling the compartment.
- Never pour undiluted liquid chlorine bleach directly onto the load or into the tub. It is a powerful chemical and can cause fabric damage, such as weakening of the fibers or color loss, if not used properly.
- If you prefer to use color-safe, nonchlorine bleach, add it to the appropriate detergent compartment. DO NOT pour color-safe bleach into the Bleach compartment.

### Loading the fabric softener compartment

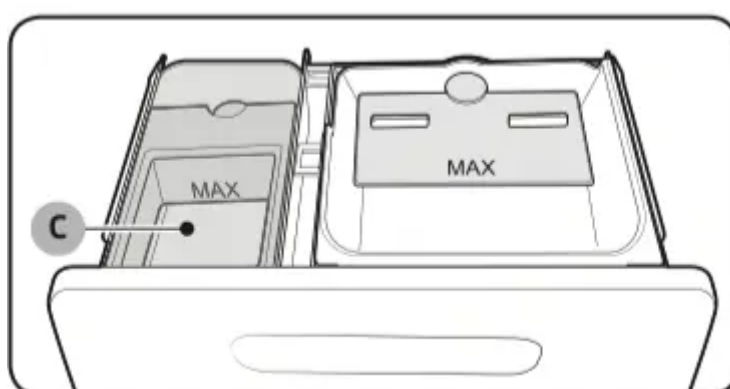

1. Pour the recommended amount of liquid fabric softener into the softener compartment (C). For smaller loads, use less than one capful.

2. Dilute the fabric softener with water until it reaches MAX FILL in the compartment.
3. The dispenser automatically releases liquid fabric softener at the proper time during the rinse cycle.

#### **NOTE**

- Use the softener compartment **ONLY** for liquid fabric softeners.
- **DO NOT** use the Downy Ball\* in the fabric softener compartment with this washer. It will not add fabric softener at the appropriate time. Use the detergent compartment.

(\* Brand names are trademarks of their respective manufacturers.)

- Do not use liquid fabric softener that is too sticky as it may not mix with the water sufficiently.

## **Maintaining your washer**

### **Cleaning the exterior**

1. Turn off the water faucets after finishing the day's washing. This will shut off the water supply to your washer and prevent the unlikely possibility of damage from escaping water. Leave the lid open to allow the inside of your washer to dry out.
2. Use a soft cloth to wipe up all detergent, bleach or other spills as they occur.
3. Clean the following as recommended: Control Panel – Clean with a soft, damp cloth. Do not use abrasive powders or cleaning pads. Do not spray cleaners directly on the panel.

### **Cleaning the interior**

Clean the interior of your washer periodically to remove any dirt, soil, odor, mold, mildew, or bacterial residue that may remain in your washer as a result of washing clothes.

Failure to follow these instructions may result in unpleasant conditions, including odors and/or permanent stains on your washer or laundry.

Hard water deposits may be removed, if needed. Use cleaners labeled "Washer safe".

### **Storing your washer**

Washers can be damaged if water is not removed from hoses and internal components before storage.

Prepare your washer for storage as follows:

1. Select the Quick Wash cycle and add bleach to the automatic dispenser. Run your washer through the cycle without a load.
2. Turn the water faucets off and disconnect the inlet hoses.

3. Unplug your washer from the electrical outlet and leave your washer lid open to let air circulate inside the drum. If your washer has been stored in below-freezing temperatures, allow time for any leftover water in your washer to thaw out before use.

### Preserving the top cover and the front frame

Do not place any heavy or sharp objects or a detergent box on the washer. They can scratch or damage the top cover of the unit.

#### NOTE

Since the entire washer has a high-gloss finish, the surface can be scratched or damaged.

Avoid scratching or damaging the surface when using the washer.

### Cleaning mesh filter

Clean the mesh filter of the water hose once or twice a year.

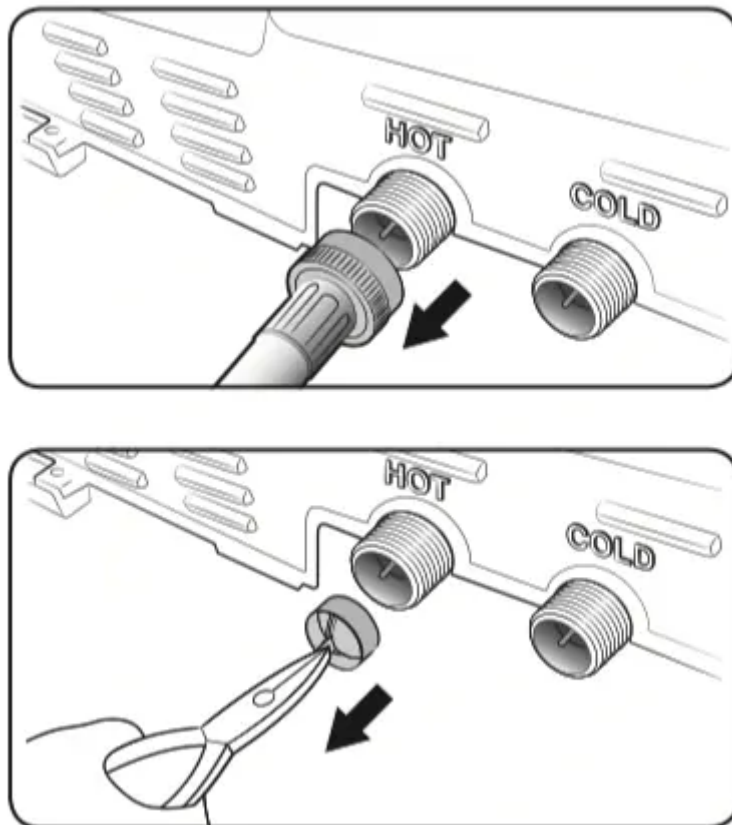

1. Turn off the washer, and then unplug the power cord.
2. Close the faucet.
3. Loosen and disconnect the water hose from the back of the washer. Cover the hose with a cloth to prevent water from gushing out.
4. Use pliers to pull out the mesh filter from the inlet valve.

5. Submerge the mesh filter deeply in water so that the threaded connector is also submerged.
6. Dry the mesh filter completely in a shaded area.
7. Reinsert the mesh filter into the inlet valve, and reconnect the water hose to the inlet valve.
8. Open the faucet.

**NOTE**

If the mesh filter is clogged, the “4C” information code appears on the the washer’s display screen.

**Cleaning the dispensers**

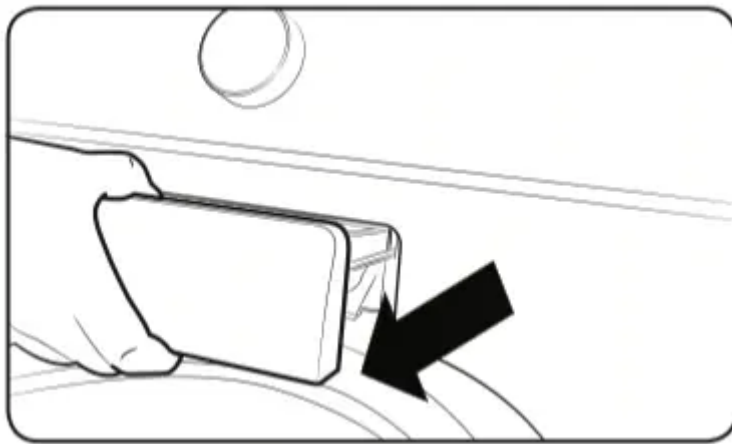

The automatic dispenser may need to be cleaned periodically due to laundry additive buildup.

1. Pull the dispenser drawer straight back until it stops.



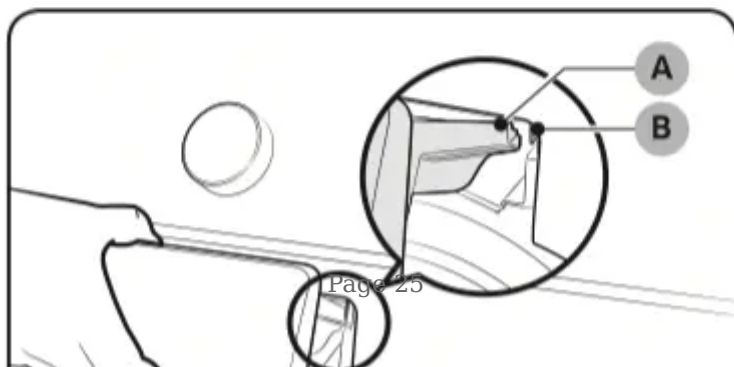
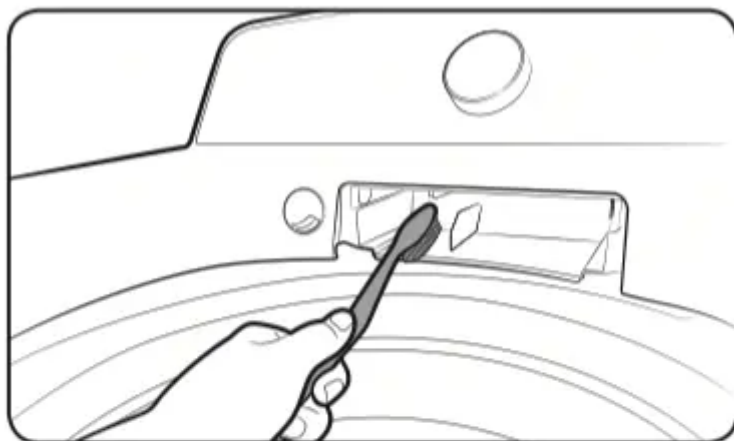
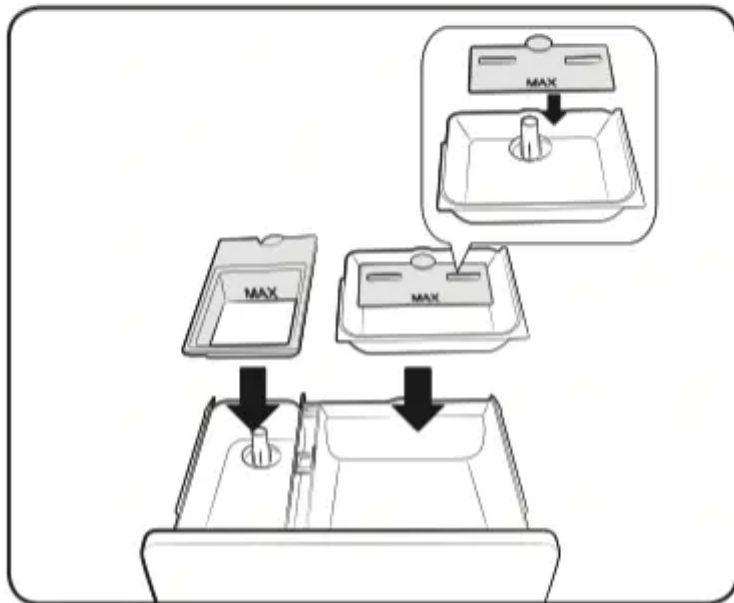
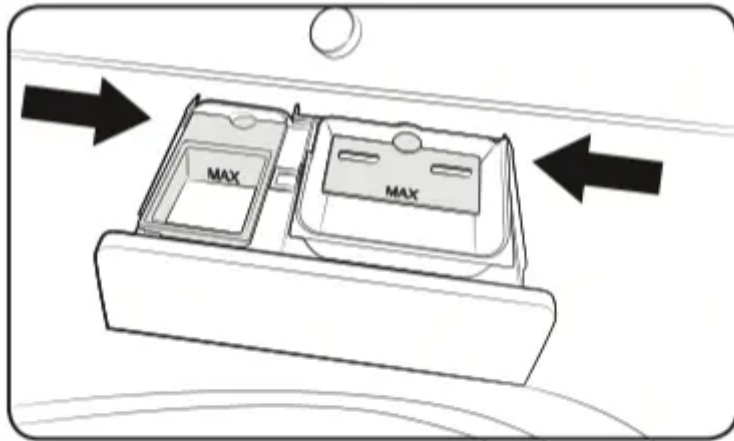

2. Push the ends of each side of the case at the same time. When you feel the ends push, pull out the dispenser drawer.
3. Remove the inserts from the 3 compartments. Rinse the inserts and the drawer with warm water to remove traces of accumulated laundry products.
4. To clean the drawer opening, use a small, non-metal brush to clean the recess. Remove all residue from the upper and lower parts of the recess.
5. Return the inserts to the proper compartments and replace the drawer by placing the dispenser drawer rail (B) on top of the compartment rail (A) (Tilt the dispenser drawer downward and insert it). Then push the drawer in firmly and slowly.

## Self Clean

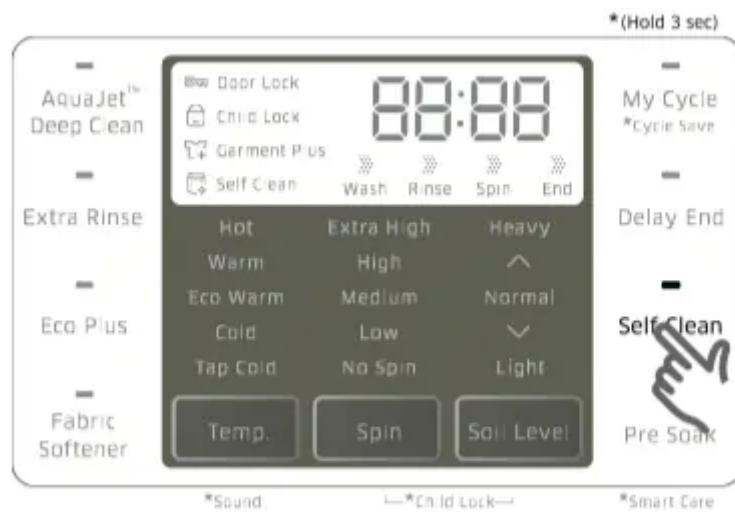

Self Clean is a self-cleaning cycle that removes mold that may occur inside the washer.





1. Press Power.
2. Select Self Clean. Once Self Clean is selected, the only function that can be set is Delay End.
3. Press Start/Pause. Self Clean begins.

### CAUTION

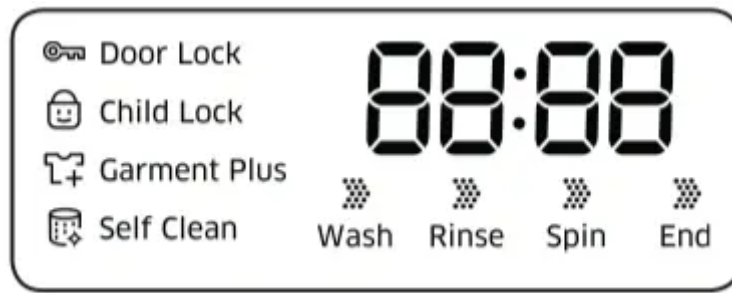
- Using Self Clean, you can clean the drum without using a cleansing agent.
- Never use Self Clean when laundry is in the washer. This may cause damage to the laundry or a problem with the washer.

### Self Clean Auto Indicator function



- If the  Self Clean indicator is lit after a wash, it indicates that tub (drum) cleaning is required. In this case, remove the laundry from the washer, turn the power on, and clean the drum by running Self Clean.
- If you do not run Self Clean, the  Self Clean indicator turns off. However, the  Self Clean indicator will light again after two washes. Not running Self Clean at this point will not cause a problem with the washer.
- Although the  Self Clean indicator is lit once a month or so, the frequency may differ depending on the number of times the washer is used.

## Troubleshooting

### Checkpoints

If you encounter a problem with the washer, first check the table below and try the suggestions.

Problem	Action
<b>Does not turn on.</b>	<ul style="list-style-type: none"> <li>• Make sure you use rated power for the product.</li> <li>• Make sure the power cord is completely plugged in.</li> <li>• Check the fuse or reset the circuit breaker.</li> </ul>
<b>Does not start.</b>	<ul style="list-style-type: none"> <li>• Make sure the door is closed.</li> <li>• Make sure the water taps are open.</li> <li>• Make sure to press or tap Start/Pause to start the washing machine.</li> <li>• Make sure Child Lock is not activated.</li> <li>• Before the washing machine starts to fill, it will make a series of clicking noises to check the door lock and does a quick drain.</li> <li>• Was the door opened during the spinning cycle? Close the door, and press or tap Start/Pause to resume.</li> <li>• The machine enters Standby or is in a soaking cycle. Please wait.</li> <li>• Check the fuse or reset the circuit breaker</li> </ul>
<b>Water is not supplied.</b>	<ul style="list-style-type: none"> <li>• Make sure you press or tap Start/Pause after selecting the water supply.</li> <li>• Make sure the water taps are open.</li> <li>• Is the filter net at the water supply hose connector clogged? Clean the filter net by brushing with a toothbrush.</li> <li>• Is the water supply cut off? If the water supply is cut off, close the tap and power off.</li> <li>• Straighten the water supply hoses.</li> <li>• Open and close the door, then press or tap Start/Pause.</li> <li>• If the water pressure is low, it takes longer to start washing.</li> <li>• If the water level is not as high as necessary or lower than expected, use the level selector to adjust the water level.</li> </ul>



<p><b>After a cycle, detergent remains in the automatic dispenser.</b></p>	<ul style="list-style-type: none"> <li>• Make sure the washing machine is running with sufficient water pressure.</li> <li>• Make sure the detergent drawer is properly inserted.</li> <li>• Remove and clean the detergent drawer, and then try again.</li> </ul>
<p><b>Vibrates excessively or makes noise.</b></p>	<ul style="list-style-type: none"> <li>• Make sure the washing machine is set on a level floor. If the floor is not level, use the levelling feet to adjust the washing machine.</li> <li>• Make sure the washing machine is not contacting any other object.</li> <li>• Make sure the laundry load is balanced.</li> <li>• Make sure the laundry is spread evenly in the washing machine. Spread out the laundry evenly and start again.</li> <li>• Make sure the space around the washing machine is free of objects.</li> <li>• Humming is produced normally during operation.</li> <li>• Objects such as coins can cause noise. Remove these objects from the washing machine after washing is complete.</li> </ul>
<p><b>Stops.</b></p>	<ul style="list-style-type: none"> <li>• Plug the power cord into a live electrical outlet.</li> <li>• Check the fuse or reset the circuit breaker.</li> <li>• Close the door, and press or tap Start/Pause to start the washing machine. For your safety, the washing machine will not spin unless the door is closed.</li> <li>• Before the washing machine starts to fill, it will make a series of clicking noises to check the door lock and does a quick drain.</li> <li>• There may be a pause or soak period in the cycle. Wait briefly and the washing machine may start.</li> <li>• Make sure the inlet hose screens at the taps are not clogged. Periodically clean the screens.</li> <li>• This problem occurs temporarily due to low voltages, and will be solved when power recovers.</li> </ul>



<p><b>Fills with the wrong temperature water.</b></p>	<ul style="list-style-type: none"> <li>• Fully open both water taps.</li> <li>• Make sure the temperature selection is correct.</li> <li>• Make sure the hoses are connected to the correct water taps.</li> </ul> <p>Flush water lines.</p> <ul style="list-style-type: none"> <li>• Disconnect the hoses and clean the screens. The hose filter screens may be clogged.</li> <li>• While the washing machine fills, the water temperature may change as the automatic temperature control feature checks incoming water temperature. This is normal.</li> <li>• While the washing machine fills, you may notice just hot and/ or just cold water going through the dispenser when cold or warm temperatures are selected.</li> </ul> <p>This is a normal function of the automatic temperature control feature as the washing machine determines the water temperature.</p>
<p><b>Door (Lid) locked or will not open.</b></p>	<ul style="list-style-type: none"> <li>• While the washing machine is operating, press or tap Start/ Pause to stop the washing machine.</li> <li>• It may take a few moments for the door lock mechanism to disengage.</li> </ul>
<p><b>Does not drain and/ or spin.</b></p>	<ul style="list-style-type: none"> <li>• Check the fuse or reset the circuit breaker.</li> <li>• Make sure the electrical voltage is normal.</li> <li>• Make sure the washing machine is plugged in.</li> <li>• Make sure the drain hose is pointed downward. (Natural drain models only)</li> <li>• Make sure the drain hose is not clogged.</li> <li>• Make sure the drain hose is not kinked.</li> <li>• Straighten the drain hose. If there is a drain restriction, call for service.</li> <li>• Close the door, and press or tap Start/Pause. For your safety, the washing machine will not spin unless the door is closed.</li> </ul>
<p><b>Load is wet at the end of the cycle.</b></p>	<ul style="list-style-type: none"> <li>• Use the High or Extra High spin speed. (Applicable model only)</li> <li>• Use high efficiency (HE) detergent to reduce oversudsing.</li> <li>• Load is too small. Small loads (one or two items) may become unbalanced and not spin completely.</li> </ul>



<p><b>Leaks water.</b></p>	<ul style="list-style-type: none"> <li>• Make sure all hose connections are tight.</li> <li>• Make sure the water supply hose's rubber packing is in the correct position. Screw tightly again.</li> <li>• Make sure the end of the drain hose is correctly inserted and secured to the drain system.</li> <li>• Avoid overloading.</li> <li>• Use high efficiency (HE) detergent to prevent oversudsing.</li> <li>• Make sure the water supply hose is not kinked.</li> <li>• If the water supply is too strong, water may leak. Close the water tap a little.</li> <li>• Make sure water is not leaking from the water tap. If so, repair the water tap.</li> </ul>
<p><b>Excessive suds.</b></p>	<ul style="list-style-type: none"> <li>• Use high efficiency (HE) detergent to prevent oversudsing.</li> <li>• Reduce the detergent amount for soft water, small loads, or lightly soiled loads.</li> <li>• Non-HE detergent is not recommended.</li> </ul>
<p><b>The spin basket or drain/supply hose is frozen.</b></p>	<ul style="list-style-type: none"> <li>• Use warm water to disconnect the water supply hose and drain hose. Soak them in warm water.</li> <li>• Fill the spin basket with warm water, and then wait for about 10 minutes.</li> <li>• Put a hot towel on the drain hose connector.</li> <li>• Reconnect the water supply hose and drain hose, and check if water is supplied properly.</li> </ul>



<p><b>Water drains out immediately.</b></p>	<ul style="list-style-type: none"> <li>• Make sure the drain hose is not clogged, and is hung over the drain hose hook. Fill the spin basket halfway with water, and try spinning again.</li> <li>• Lift the end of the drain hose to prevent water from draining.</li> </ul> <p>Fill the spin basket halfway with water, and then run spinning after releasing the drain hose.</p> <ul style="list-style-type: none"> <li>• Make sure the drain hose is installed correctly. See the installation section of this user manual and adjust the position of the drain hose as instructed.</li> </ul>
<p><b>Stains on clothes.</b></p>	<ul style="list-style-type: none"> <li>• Clean the magic filter.</li> </ul>

<p><b>Has odours.</b></p>	<ul style="list-style-type: none"> <li>• Excessive suds collect in recesses and can cause foul odours.</li> <li>• Run cleansing cycles to sanitize periodically.</li> <li>• Dry the washing machine interior after a cycle has finished.</li> </ul>
---------------------------	---

If a problem persists, contact a local Samsung service center.

## Information codes

The washer may display information codes to help you understand what is occurring with your washer better.

No	Code.	Meaning
1	<b>1C</b>	<p>The WaterLevel sensor is not working properly.</p> <ul style="list-style-type: none"> <li>• Check WaterLevel Sensor wire harness.</li> <li>• If the information code remains, contact a customer service centre.</li> </ul> <p><b>NOTE</b></p> <p>When the washer displays “1C”, the washer do draining for 3 minutes. During this time, the Power button is inoperative.</p>
2	<b>3C</b>	<p>Check the motor for operation.</p> <ul style="list-style-type: none"> <li>• Try restarting the cycle.</li> <li>• If the problem continues, call for service.</li> </ul>
3	<b>4C</b>	<p>Water is not supplied.</p> <ul style="list-style-type: none"> <li>• Make sure the water taps are open.</li> <li>• Make sure the water hoses are not clogged.</li> <li>• Make sure the water taps are not frozen.</li> <li>• Make sure the washing machine is operating with sufficient water pressure.</li> <li>• Make sure that the cold water tap and the hot water tap are properly connected.</li> <li>• Clean the mesh filter as it may be clogged.</li> </ul> <p><b>NOTE</b></p> <p>When the washer displays “4C”, the washer do draining for 3 minutes. During this time, the Power button is inoperative.</p>
4	<b>4C2</b>	<ul style="list-style-type: none"> <li>• Make sure the cold water supply hose is firmly connected to the cold water tap.</li> </ul> <p>If it is connected to the hot water tap, the laundry may be deformed with some cycles.</p>
5	<b>5C</b>	<p>Water is not draining.</p> <ul style="list-style-type: none"> <li>• Make sure the drain hose is not frozen or clogged.</li> <li>• Make sure the drain hose is positioned correctly, depending on the connection type.</li> <li>• Clean the debris filter as it may be clogged.</li> </ul>



		<ul style="list-style-type: none"> <li>• Make sure the drain hose is straightened all the way to the drain system.</li> <li>• If the information code remains, contact a customer service centre.</li> </ul>
6	<b>9C1</b>	<p>The electronic control needs to be checked (Over Voltage Error).</p> <ul style="list-style-type: none"> <li>• Check the PCB and wire harness.</li> <li>• Check if power is supplied properly.</li> <li>• If the information code remains, contact a customer service centre.</li> </ul>
7	<b>9C2</b>	<p>Low voltage detected</p> <ul style="list-style-type: none"> <li>• Check if the power cord is plugged in.</li> <li>• If the information code remains, contact a customer service centre.</li> </ul>
8	<b>AC6</b>	<p>Inverter Communication problem</p> <ul style="list-style-type: none"> <li>• Check the Inverter PCB and wire harness.</li> <li>• If the information code remains, contact a customer service centre.</li> </ul>
9	<b>dC</b>	<p>Operating the washer with the door open.</p> <ul style="list-style-type: none"> <li>• Make sure the door is properly closed.</li> <li>• Make sure laundry is not caught in the door.</li> </ul>
10	<b>HC</b>	<p>High temperature heating check.</p> <ul style="list-style-type: none"> <li>• If the information code remains, contact a customer service centre.</li> </ul>

11	<b>LC.</b>	<p>Check the drain hose.</p> <ul style="list-style-type: none"> <li>• Make sure the end of the drain hose is placed on the floor.</li> <li>• Make sure the drain hose is not clogged.</li> <li>• If the information code remains, contact a customer service centre.</li> </ul> <p>NOTE</p> <p>When the washer displays “LC”, the washer do draining for 3 minutes. During this time, the Power button is inoperative.</p>
12	<b>OC</b>	<p>Water is overflowed.</p> <ul style="list-style-type: none"> <li>• Restart after spinning.</li> <li>• If the information code remains on the display, contact a local Samsung service centre.</li> </ul>
13	<b>PC</b>	<p>When position of the clutch can't be detected.</p> <ul style="list-style-type: none"> <li>• If the information code remains, contact a customer service centre.</li> </ul>
14	<b>PC1</b>	<p>After position of the clutch is detected, if the signal of the clutch hall goes wrong.</p> <ul style="list-style-type: none"> <li>• If the information code remains, contact a customer service centre.</li> </ul>
15	<b>Ub</b>	<p>Spinning does not work.</p> <ul style="list-style-type: none"> <li>• Make sure laundry is spread out evenly.</li> <li>• Make sure the washing machine is on a flat, stable surface.</li> <li>• Redistribute the load. If only one item of clothing needs washing, such as a bathrobe or pair of jeans, the final spin result might be unsatisfactory, and an “Ub” check message will be</li> </ul> <p>1. shown in the display.</p>

For any codes not listed above, call 1–800–726–7864 (1–800–SAMSUNG).

### Warning

This content is compiled from multiple sources and is provided for reference purposes only. It may not be complete or fully applicable to all situations. If you are unable to resolve your issue, please contact the product manufacturer or an authorized service provider for official support.

