

## Shelves and Bins

### Refrigerator Door Bins and Freezer Door Tilt-Out Bins

#### Large Bins

The larger refrigerator door bins freezer tilt-out door bins are adjustable.

**To remove:** Lift the front of the bin straight up, then lift up and out.

**To replace or relocate:** Engage the back side of the bin in the molded supports of the door. Then push down on the front of the bin. Bin will lock in place.

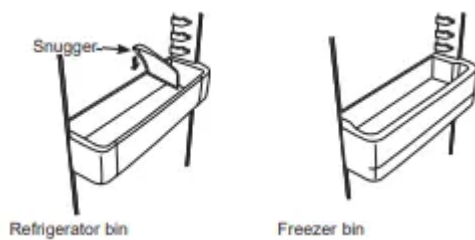

#### Small Bins

**To remove:** Lift the front of the bin straight up then out.

**To replace:** Position the bin above the rectangular molded supports on the door. Then slide the bin down onto the support to lock it in place.

The snagger helps prevent tipping, spilling or sliding of small items stored on the door shelf. Place a finger on either side of the snagger near the rear and move it back and forth to fit your needs.

NOTE: Be careful when placing items in the top bin. Make sure that items do not block or fall into the ice chute.

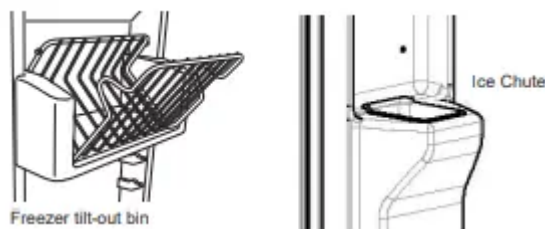

### Slide-Out Shelf (on some models)

The slide-out shelf allows you to reach items stored behind others. The special edges of the spillproof shelf are designed to help prevent spills from dripping to lower shelves.

#### Spillproof Shelf

**To remove:** Slide the shelf out until it reaches the stop, then press down on the tab and slide the shelf straight out.

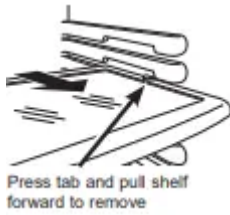

**To replace or relocate:** Line the shelf up with the supports and slide it into place. The shelf can be repositioned when the door is at 90° or more. To reposition the shelf, slide the shelf past the stops and angle downward. Slide shelf down to the desired position, line up with the supports and slide into place. Make sure you push the shelves all the way back in before you close the door.

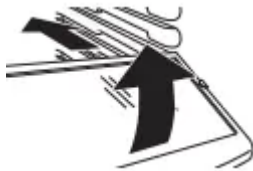

### Edge-to-Edge Shelf

**To remove:** With door opened at an angle greater than 90°, slide the shelf out until it reaches the stop tab. Press down on the tab and slide the shelf out until it reaches the shelf's back trim. While keeping the left side of the shelf in contact with the cabinet, pull the shelf down and forward toward the left to remove.

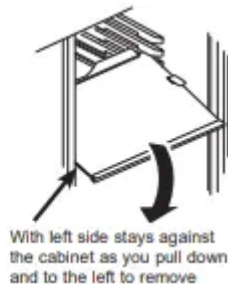
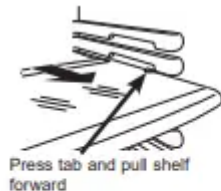

**To replace or relocate:** With door opened at an angle greater than 90°, align the shelf's back trim against the shelf support. Keeping the left side against the cabinet, slowly lift and gently push the shelf back into place. Reposition the shelf past the stop tabs. Make sure you push the shelves all the way back in before you close the door.

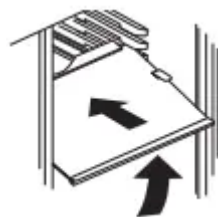

### Freezer Baskets (on some models)

To remove, slide out to the stop position, lift the front past the stop position, and slide out. Make sure you push the baskets all the way back in before you close the door.



### Freezer Baskets (on some models)

**To remove**, push the basket all the way to the back of the freezer. Lift up until the back pins are disengaged. Lift the entire basket up and pull out.

Make sure you push the baskets all the way back in before you close the door.



### QuickSpace™ Shelf (on some models)

This shelf splits in half and slides under itself for storage of tall items on the shelf below.

This shelf can be removed and replaced or relocated just like Slide-Out Spillproof Shelves.

On some models, this shelf can not be used in the lowest position.



### Slide-Out Freezer Shelves

To remove, slide out to the stop position, lift the front past the stop position, and slide out from rib.

Make sure you push the shelves all the way back in before you close the door.



### Fixed Freezer Shelves

To remove, lift the shelf up at the left side and then bring the shelf out.

**NOTE FOR DISPENSER MODELS:** In order to take full advantage of the tilt-out ice bin (on some models), only store items on the shelf below the ice bin that are no taller than the lowest point on the bin.

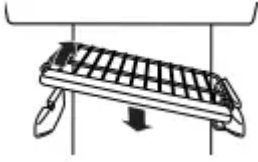

## Refrigerator Doors

### Refrigerator Doors (on some models)

The refrigerator doors may feel different than the ones you are used to. The special door opening/closing feature makes sure the doors close all the way and are securely sealed.

When opening and closing the door you will notice a stop position. If the door is opened past this stop point, the door will remain open to allow you to load and unload food more easily. When the door is only partially open, it will automatically close.

The resistance you feel at the stop position will be reduced as the door is loaded with food.

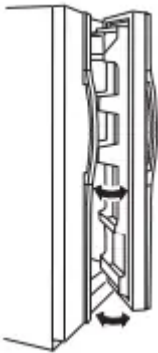

*When the door is only partially open, it will automatically close.*

*Beyond this stop the door will stay open.*

### Door Alignment

If doors are uneven, adjust the refrigerator door.

To remove the base grille, open the doors, remove the screw at each end of the base grille and then pull the grille straight out.

1. Using a 7/16" socket wrench, turn the door adjusting screw to the right to raise the door; to the left, to lower it. (A nylon plug, imbedded in the threads of the pin, prevents the pin from turning unless a wrench is used.)
2. After one or two turns of the wrench, open and close the refrigerator door and check the alignment at the top of the doors.

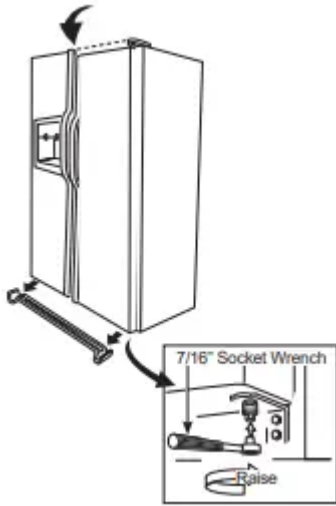

## Crispers and Pans

### Fruit and Vegetable Crispers

Excess water that may accumulate in the bottom of the drawers should be wiped dry.

On some models, the bottom drawer has full extension slides that allow full access to the drawer



### Adjustable Humidity Crispers

Slide the control all the way to the LO setting to provide high humidity recommended for most vegetables.

Slide the control all the way to the HI setting to provide lower humidity levels recommended for most fruits.

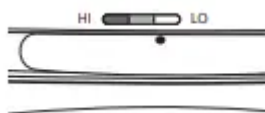

### Crisper Removal

Crispers can easily be removed by pulling the drawer straight out and lifting the drawer up and over the stop location.

If the door prevent you from taking out the drawers, first try to remove the door bins. If this does not offer enough clearance, the refrigerator will need to be rolled forward until the door opens enough to slide the drawer out. In some cases, when you roll the refrigerator out, you will need to move the refrigerator to the left or right as you roll it out.



### **Convertible Deli Pan (on some models)**

The convertible deli pan has its own cold air duct to allow a stream of cold air from the freezer compartment or refrigerator compartment to flow to the pan.

The variable temperature control regulates the air flow from the Climate Keeper. Set the control to the coldest setting to store fresh meats.

Set the control to cold to convert the pan to normal refrigerator temperature and provide extra vegetable storage space. The cold air duct is turned off. Variable settings between these extremes can be selected.

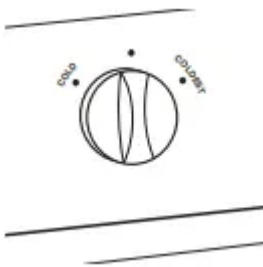

### **How to Remove and Replace the Drawer**

To remove:

1. Pull the drawer out to the stop position.
2. Rotate all four swing locks to the unlock position.
3. Lift the front of the drawer up and out.

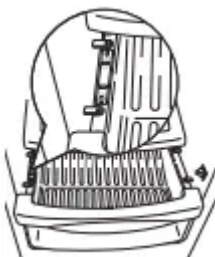

To replace:

1. Make sure all four swing locks are in the unlock position.
2. Place the sides of the drawer into the drawer supports, making sure the swing locks fit on the drawer slots.
3. Lock all four swing locks by rotating them to the lock position.



## Automatic Icemaker

Not all features are on all models.

The icemaker will produce seven cubes per cycle— approximately 100–130 cubes in a 24-hour period, depending on freezer compartment temperature, room temperature, number of door openings and other use conditions.

If the refrigerator is operated before the water connection is made to the icemaker, set the power switch in the OFF position.

When the refrigerator has been connected to the water supply, set the power switch to the ON position.

The icemaker will fill with water when it cools to 15°F (–10°C). A newly installed refrigerator may take 12 to 24 hours to begin making ice cubes.

You will hear a buzzing sound each time the icemaker fills with water.

Throw away the first few batches of ice to allow the water line to clear.

Be sure nothing interferes with the sweep of the feeler arm.

When the bin fills to the level of the feeler arm, the icemaker will stop producing ice. It is normal for several cubes to be joined together. If ice is not used frequently, old ice cubes will become cloudy, taste stale and shrink.

**CAUTION** Avoid contact with the moving parts of the ejector mechanism, or with the heating element (located on the bottom of the ice maker) that releases the cubes. Do not place fingers or hands on the automatic ice making mechanism while the refrigerator is plugged in.

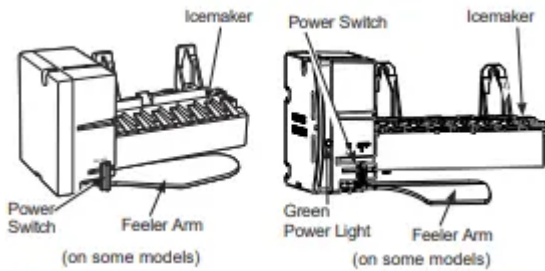

### Special note about dispenser models:

- Some models have a tilt-out ice bin. The bin can be tilted out as shown in the illustrations, and it will hold itself up while you take ice out or turn the icemaker power switch on and off. Be sure to put the bin back in place before closing the door.
- To restore your ice level from an empty bucket stage, the following steps are recommended:
  1. 12 hours after the first batch of ice has fallen into the bin, dispense 3 to 4 cubes.
  2. After an additional 6 hours, dispense 3 to 4 cubes again.

These steps will restore your ice level in the shortest amount of time.

**NOTE:** In homes with lower than average water pressure, you may hear the icemaker cycle multiple times when making one batch of ice.

### Accessing Ice and Reaching the Power Switch on Dispenser Models

There are two types of ice storage bins on dispenser models. One has a shelf above the bin, the other does not

#### Special note for models with tilt-out ice bin:

- These models have a tilt-out tilted out ice bin. The bin can be as shown in the illustrations, and it will hold itself up while you take ice out or turn the icemaker power switch on and off. Be sure to put the bin back in place before closing the door.

**NOTE:** In order to take full advantage of the tilt-out ice bin, only store items on the shelf below the ice bin that are no taller than the lowest point on the bin.

#### Models with tilt out ice bin

To access ice and reach the icemaker power switch:

1. Lift the bin, then pull it forward until the bin stops.



2. Lower the bin to access ice or reach the power switch.



### Models with a shelf above the ice bin

To access ice, pull the bin forward.

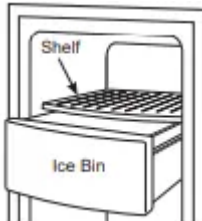

To reach the power switch, pull the shelf straight out. Always be sure to replace the shelf.



### On some models, to access ice or reach the power switch:

1. Pull the bin forward until the bin stops.

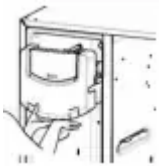

2. Lower the bin to access ice or reach the power switch.

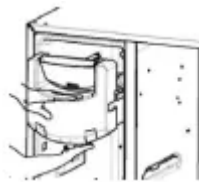

### Removing Ice Bin (dispenser models)

**CAUTION** These models have a tilt-out tilted out ice. The ice bin is heavy when full.

Set the power switch to the OFF position before removing the bin.

When replacing the bin, be sure to press it firmly into place. If it does not go all the way back, remove it and rotate the drive mechanism 1/4 turn. Then push the bin back again. The bin can be as shown in the illustrations, and it will hold itself up while you take ice out or turn the icemaker power switch on and off. Be sure to put the bin back in place before closing the door.

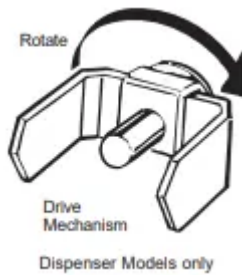

## Ice and Water Dispenser (on some models.)

### Using the Dispenser



Select CUBED ICE .

CRUSHED ICE .

or WATER .

Press the glass gently against the top of the dispenser cradle.

The spill shelf is not selfdraining. To reduce water spotting, the shelf and its grille should be cleaned regularly.

If no water is dispensed when the refrigerator is first installed, there may be air in the water line system. Press the dispenser arm for at least two minutes to remove trapped air from the water line and to fill the water system. To flush out impurities in the water line, throw away the first six glassfuls of water.

### Locking the Dispenser

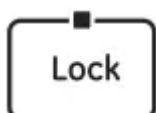

Press the LOCK pad for 3 seconds to lock the dispenser and control panel. To unlock, press and hold the pad again for 3 seconds.

### Dispenser Light



This pad turns the light in the dispenser on and off. The light also comes on when the dispenser cradle is pressed. For models with a bulb, if the light burns out, it should be replaced with a 6 watt 12V maximum bulb. For LED models, contact Factory Service.

#### **Quick Ice (on some models)**

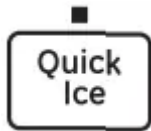

When you need ice in a hurry, press this pad to speed up ice production. This will increase ice production for the following 48 hours or until you press the pad again.

#### **Door Alarm (on some models)**



To set the alarm, press this pad until the indicator light comes on. This alarm will sound if either door is open for more than 3 minutes. The light goes out and the beeping stops when you close the door.

#### **Water Filter (on some models)**



The Filter Indicator Light will turn yellow when the filter is nearing expiration., and red when the filter is expired. After you replace the water filter, press and hold the Reset Filter pad for 3 seconds until the light turns off to reset the timer

#### **Filter Status (on some models)**



Press the Filter Status pad to display the water filter's life percentage (%).

## Important Facts About Your Dispenser

- Do not add ice from trays or bags to the storage drawer. It may not crush or dispense well.
- Avoid overfilling glass with ice and use of narrow glasses. Backed-up ice can jam the chute or cause the door in the chute to freezer shut. If ice is blocking the chute, poke it through with a wooden spoon.
- Beverages and foods should not be quick-chilled in the ice storage drawer. Cans, bottles or food packages in the storage drawer may cause the icemaker or auger to jam.
- To keep dispensed ice from missing the glass, put the glass close to, but not touching, the dispenser opening.
- Some crushed ice may be dispensed even though you selected CUBED ICE. This happens occasionally when a few cubes accidentally get directed to the crusher.
- After crushed ice is dispensed, some water may drip from the chute.
- Sometimes a small mound of snow will form on the door in the ice chute. This condition is normal and usually occurs when you have dispensed crushed ice repeatedly. The snow will eventually evaporate.

## Care and Cleaning

### Cleaning the Outside



The dispenser drip area, (on some models) beneath the grille, should be wiped dry. Water left in this area may leave deposits. Remove the deposits by adding undiluted vinegar to the well. Soak until the deposits disappear or become loose enough to rinse away.

The dispenser cradle (on some models). Before cleaning, lock the dispenser by pressing and holding the LOCK pad for 3 seconds. Clean with warm water and baking soda solution—about a tablespoon (15 ml) of baking soda to a quart (1 l) of water. Rinse thoroughly and wipe dry.

### Cleaning the Inside

To help prevent odors, leave an open box of baking soda in the refrigerator and freezer compartments.

Unplug the refrigerator before cleaning. If this is not practical, wring excess moisture out of sponge or cloth when cleaning around switches, lights or controls.

Use warm water and baking soda solution— about a tablespoon (15 ml) of baking soda to a quart (1 liter) of water. This both cleans and neutralizes odors. Rinse and wipe dry.

Use of any cleaning solution other than that which is recommended, especially those that contain petroleum distillates, can crack or damage the interior of the refrigerator.

**CAUTION** Do not clean glass shelves or covers with warm water when they are cold. Glass shelves and covers may break if exposed to sudden temperature changes or impact such as bumping or dropping.

Tempered glass is designed to shatter into many small pieces if it breaks.

Do not wash any plastic refrigerator parts in the dishwasher.

The chill/thaw tray is dishwasher safe.

### **Behind the Refrigerator**

Be careful when moving the refrigerator away from the wall. All types of floor coverings can be damaged, particularly cushioned coverings and those with embossed surfaces.

Pull the refrigerator straight out and return it to position by pushing it straight in. Moving the refrigerator in a side direction may result in damage to the floor covering or refrigerator.

When pushing the refrigerator back, make sure you don't roll over the power cord or icemaker supply line (on some models).

### **Preparing for Vacation**

For long vacations or absences, remove food and unplug the refrigerator. Clean the interior with a baking soda solution of one tablespoon (15 ml) of baking soda to one quart (1 liter) of water. Leave the doors open.

Set the icemaker power switch to the OFF position and shut off the water supply to the refrigerator.

If the temperature can drop below freezing, have a qualified servicer drain the water supply system (on some models) to prevent serious property damage due to flooding.

### **Preparing to Move**

Secure all loose items such as shelves and drawers by taping them securely in place to prevent damage.

When using a hand truck to move the refrigerator, do not rest the front or back of the refrigerator against the hand truck. This could damage the refrigerator. Handle only from the sides of the refrigerator.

Be sure the refrigerator stays in an upright position during moving.

### **Replacing the lights on models with LED lighting (on some models)**

Setting the controls to OFF does not remove power to the light circuit. Not all features are on all models.

### **Refrigerator Compartment**

There is an LED lighting display in the top and sides of the refrigerator compartment and in the rear and side of

If this assembly needs to be replaced, call GE Appliances Service at 1.800.432.2737 in the United States or 1.800.561.3344 in Canada.

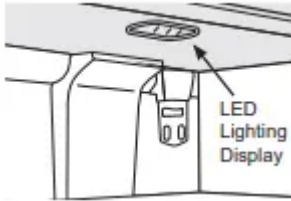

## Installation Instructions

### LOADING THE REFRIGERATOR ONTO A HAND TRUCK

Leave all tape and door pads on doors until the refrigerator is in its final location.

To move the refrigerator, use a padded hand truck. Center the refrigerator on the hand truck and secure the strap around the refrigerator.

DO NOT OVERTIGHTEN THE STRAP.

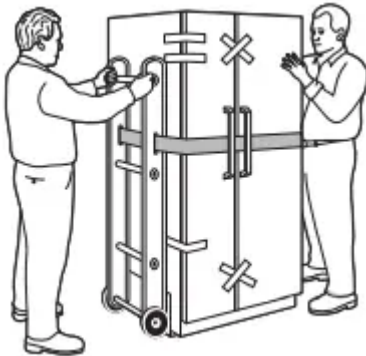

### REMOVE THE BASE GRILLE

Remove the grille by removing the two Phillips head screws.

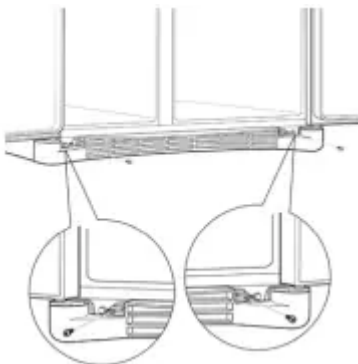

### DISCONNECT THE WATER COUPLING (on some models)

If the refrigerator has a water dispenser, there is a water line from the cabinet into the bottom hinge on the freezer door that must be disconnected.

To disconnect, push in on the white collar of the coupling and pull out the tubing.

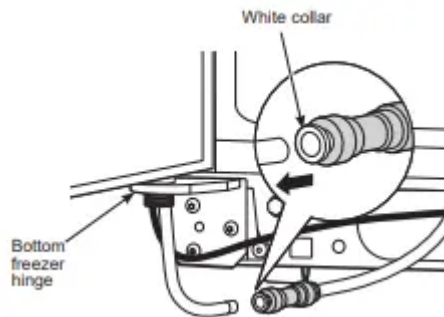

### DISCONNECT THE ELECTRICAL CONNECTORS (on some models)

If the refrigerator has a refreshment center, there are electrical connectors (harnesses) from the cabinet into the bottom hinge on the refrigerator door that must be disconnected. To disconnect, pull apart each connector.

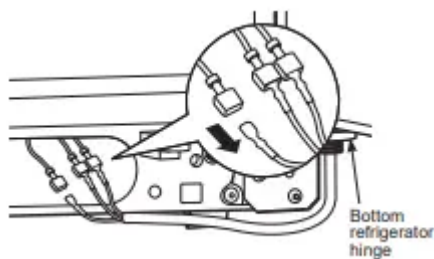

### REPLACING THE DOORS

To replace the doors, simply reverse steps 3 through 8.

However, please note the following:

- When lowering the doors onto the bottom hinges, make sure the second person carefully guides the tube and harnesses through the holes in the hinges.
- When connecting the water line, make sure you insert the tubing all the way to the mark.

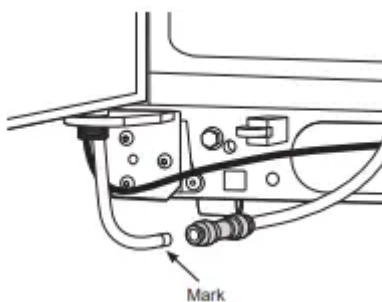

- Do not pinch the tubing and harnesses when placing the doors on the bottom hinges.
- When connecting the power line and the electrical lines (refreshment center models only), be sure that the connectors are seated together fully.

## Troubleshooting Tips

### Filter Status Indicator LED turns amber

- Filter reaching expired state

Press the Filter Status pad to show remaining filter life.

### Filter Status Indicator LED turns red

- Filter expired

Press the Filter Status pad to show remaining filter life.

If the display shows 0%, the filter needs to be replaced.

When the unit has detected a new filter (a filter has been replaced) the Filter Status LED will flash 3 times and then remain off to indicate the filter was successfully replaced.

### LEAK or scrolling “LEAK” on the display Water is disabled

#### Filter Status indicator LED flashing red Buzzer sound

- Filter leak detected

Replace filter.

Wipe off the filter/surrounding area if there is any water from filter replacement.

### “Err” on the display Water is disabled

#### Filter Status indicator LED flashing red Buzzer sound

- Filter is not detected
- No communication with filter

Verify you have the XWFE filter and not the XWF.

Verify there are no scratches or filter label damage.

Replace filter if filter label shows damage.

### Refrigerator beeps when pressing dispenser paddle

- Filter is not properly installed
- Filter water leak

Replace filter or make sure the water filter is properly installed (see water filter section).

### Refrigerator does not operate

- Refrigerator in defrost cycle.

Wait about 30 minutes for defrost cycle to end.

- Freezer control in OFF position.

Move the freezer control to a lower temperature setting.

- Refrigerator is unplugged.

Push the plug completely into the outlet.

- The fuse is blown/circuit breaker is tripped.

Replace fuse or reset the breaker.

- Refrigerator is in showroom mode.

Unplug the refrigerator and plug it back in.

### **Vibration or rattling (slight vibration is normal)**

- Rollers need adjusting.

See Rollers.

### **Motor operates for long periods or cycles on and off frequently. (Modern refrigerators with more storage space and a larger freezer require more operating time. They start and stop often to maintain even temperatures.)**

- Normal when refrigerator is first plugged in.

Wait 24 hours for the refrigerator to completely cool down.

- Often occurs when large amounts of food are placed in refrigerator.

This is normal.

- Door left open.

Check to see if package is holding door open.

- Hot weather or frequent door openings.

This is normal.

- Temperature controls set at the coldest setting.

See Controls.

### **Refrigerator or freezer compartment too warm**

- Temperature control not set cold enough.

See Controls.

- Warm weather or frequent door openings.

Set the temperature control one step colder. See Controls.

- Door left open.

Check to see if package is holding door open.

### **Frost or ice crystals on frozen food (frost within package is normal)**

- Door left open.
- Too frequent or too long door openings.

Check to see if package is holding door open.

### **Divider between refrigerator and freezer compartments feels warm**

- Automatic energy saver system circulates warm liquid around front edge of freezer compartment.

This helps prevent condensation on the outside.

### **Automatic icemaker does not work**

- Icemaker switch is in the OFF position.

Slide the switch to the ON position.

- Water supply turned off or not connected.

See Installing the water line.

- Freezer compartment too warm.

Wait 24 hours for the refrigerator to completely cool down.

- Piled up cubes in the storage bin cause icemaker to shut off.

Level cubes by hand.

- Ice cubes stuck in icemaker.

Turn off the icemaker, remove cubes and turn the icemaker back on.

- Filter is not properly installed. Filter water leak

Replace filter or make sure the water filter is properly installed (refer to water filter section).

### **Ice cubes have odor/taste**

- Ice storage bin needs cleaning.

Empty and wash bin, Discard old cubes.

- Food transmitting odor/taste to ice cubes.

Wrap foods well.

- Interior of refrigerator needs cleaning.

See Care and cleaning.

### **Small or hollow cubes**

- Water filter clogged

Replace filter cartridge with new cartridge or with plug.

### **Slow ice cube freezing**

- Door left open.

Check to see if package is holding door open.

- Temperature control not set cold enough.

See Controls.

### **Frequent “buzzing sound”**

- Icemaker switch is in the ON position, but the water supply to the refrigerator has not been connected.

Set the switch to the OFF position. Keeping it in the ON position will damage the water valve.

### **Red / Orange glow in the freezer section, steam coming from vents. Popping/ hissing sound coming from the freezer area.**

- This is normal operation for glass defrost heater models. The heater is clearing out frost from your refrigerator evaporator for optimum operation.

Do not touch the vent area or unplug the refrigerator. It is normal operation and the heater will turn off once the frost has been cleared.

### **Cube dispenser does not work (on some models)**

- Icemaker or water supply turned off.

Turn on icemaker or water supply.

- Ice cubes are frozen to icemaker feeler arm.

Remove cubes.

- An item is blocking or has fallen into the ice chute inside the top bin of the freezer.

Remove any item that might be blocking, or has fallen into the chute.

- Irregular ice clumps in storage container.

Break up with fingertip pressure and discard remaining clumps.

Freezer may be too warm. Adjust the freezer control to a colder setting, one position at a time, until clumps do not form.

- Dispenser is LOCKED.

Press and hold the Lock pad for 3 seconds.

### **Water has poor taste/odor (on some models)**

- Water dispenser has not been used for a long time.

Dispense water until all water in system is replenished.

### **Water in first glass is warm (on some models)**

- Normal when refrigerator is first installed

Wait 24 hours for the refrigerator to completely cool down.

- Water dispenser has not been used for a long time.

Dispense water until all water in system is replenished.

- Water system has been drained.

Allow several hours for replenished supply to chill.

### **Water dispenser does not work (on some models)**

- Water supply line turned off or not connected.

See Installing the water line.

- Water filter clogged.

Replace filter cartridge or remove filter and install plug.

- Air may be trapped in the water system.

Press the dispenser arm for at least two minutes.

- Dispenser is LOCKED.

Press and hold the Lock pad for 3 seconds.

### **Water spurting from dispenser**

- Newly-installed filter cartridge.

Run water from the dispenser for 3 minutes (about 1 1/2 gallons).

### **Water is not dispensed (on some models) but icemaker is working**

- Water in reservoir is frozen.

Call for service.

- Refrigerator control setting is too cold.

Set to a warmer setting.

### **No water or ice cube production**

- Supply line or shutoff valve is clogged.

Call a plumber.

- Water filter clogged.

Replace filter cartridge or remove filter and install plug.

- Dispenser is LOCKED.

Press and hold the CLOCK CONTROLS pad for 3 seconds.

- Filter is not properly installed. Filter water leak

Replace filter or make sure the water filter is properly installed (refer to water filter section).

### **CUBED ICE was selected but CRUSHED ICE was dispensed (on some models)**

- Last setting was CRUSHED ICE.

A few cubes were left in the crusher from the previous setting. This is normal.

### **Refrigerator has odor**

- Foods transmitting odor to refrigerator.

Keep an open box of baking soda in the refrigerator replace every three months.

- Interior needs cleaning.

See Care and cleaning.

### **Moisture forms on outside of refrigerator**

- Not unusual during periods of high humidity.

Wipe surface dry.

### **Moisture collects inside (in humid weather, air carries moisture into refrigerator when doors are opened)**

- Too frequent or too long door openings.

This is normal for the beverage center.

- Due to the higher humidity in the refrigerator, you may on occasion experience fog or small amounts of moisture in the refrigerator compartment

This is normal for the beverage center loads and environmental conditions change with a paper towel if desired.

### **Interior light does not work**

- No power at outlet.

Replace fuse or reset the breaker.

- Light bulb burned out.

See Replacing the light bulbs.

- For LED lights.

Call Service.

### **Water on kitchen floor or on bottom of freezer**

- Cubes jammed in chute.

Poke ice through with a wooden spoon.

### **Hot air from bottom of refrigerator**

- Normal air flow cooling motor. In the refrigeration process, it is normal that heat be expelled in the area under the refrigerator. Some floor coverings are sensitive and will discolor at these normal and safe temperatures.

This is normal.

### **Refrigerator never shuts off but the temperatures are OK**

- Adaptive defrost keeps compressor running during door openings.

This is normal. The refrigerator will cycle off after the door remains closed for 2 hours.

### **Refrigerator is beeping**

- Door is open.

Close door.

### **Door not closing properly**

- Door gasket on hinge side sticking or folding over.

Apply petroleum jelly on face of gasket

### **Actual temperature not equal to Set temperature**

- Unit just plugged in.

Allow 24 hours for system to stabilize

- Door open for too long.

Allow 24 hours for system to stabilize

- Warm food added to refrigerator

Allow 24 hours for system to stabilize

- Defrost cycle is in process

Allow 24 hours for system to stabilize

### **Warning**

This content is compiled from multiple sources and is provided for reference purposes only. It may not be complete or fully applicable to all situations. If you are unable to resolve your issue, please contact the product manufacturer or an authorized service provider for official support.

---

Document generated by [ManualsFile](#)

