

Setting Up the Label Printer

Parts Description

Front

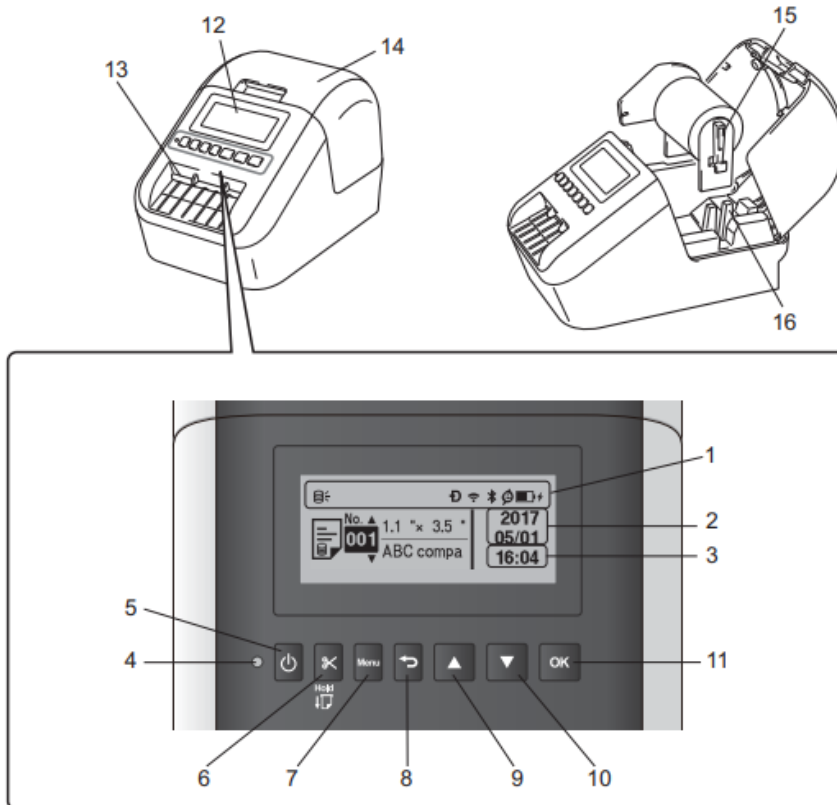

1. Indicator Display
2. Date Display
3. Time Display
4. Status LED
5. Power Button
6. Cutter Button
7. Menu Button
8. Cancel Button
9. Up Arrow Button
10. Down Arrow Button
11. OK Button
12. LCD

13. Label Output Slot
14. DK Roll Compartment Cover
15. Roll Spool Arm
16. Roll Spool Guide

Rear

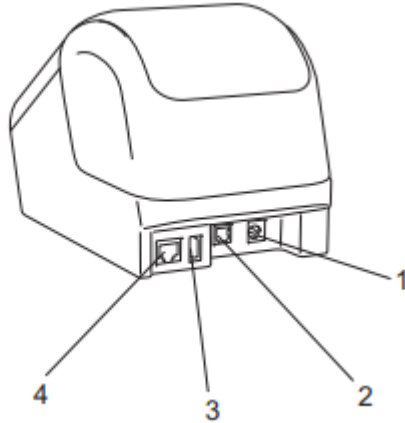

1. AC Adapter Port
2. USB Port
3. USB Host
4. LAN Port

Before using the Label Printer, make sure you remove the Protective Sheet, as shown below:

1. Make sure that the Label Printer is turned Off. Hold the Label Printer by the front, and firmly lift the DK Roll Compartment Cover to open it.
2. Remove the Protective Sheet from the Label Output Slot.



- Do not throw away the Protective Sheet.
- When the Label Printer is not in use, lift the DK Roll Compartment Cover and remove any DK Rolls from inside the Label Printer. Then, insert the Protective Sheet into the Label Output Slot to maintain good printing quality

Loading the DK Roll

1. Make sure that the Label Printer is turned Off. Hold the Label Printer by the front, and firmly lift the DK Roll Compartment Cover to open it.



2. After removing the Protective Sheet, place the DK Roll into the Roll Spool Guide.

- Make sure that the Roll Spool Arm is inserted firmly in the Roll Spool Guide.
- Make sure the Stabilizer (1) slides into the notch of the Label Printer.



3. Thread the DK Roll through the Label Printer.

- Align the edge of the DK Roll with the upright edge of the Label Output Slot.
- Insert the first label into the slot inside the compartment.
- Push the label through the Label Output Slot until the end reaches the mark, as shown below.

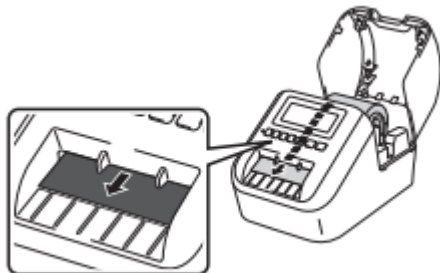

4. Close the DK Roll Compartment Cover. When you press the Power  Button to turn the Label Printer On, the end of the DK Roll aligns automatically.

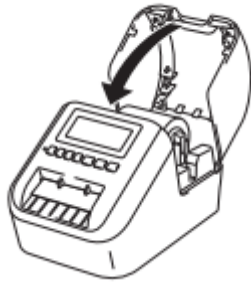

Connecting the AC Adapter

Connect the AC Adapter to the Label Printer and to the AC Power Cord. Then, plug the AC Power Cord into a grounded AC power outlet.

The PA-BU-001 (optional Battery Unit) can also be used.

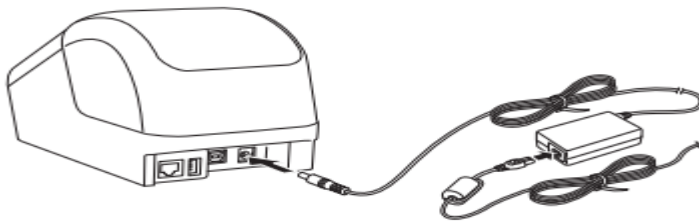

Setting LCD Language (QL-820NWB only)

1. Press the Menu Button.
2. Press the ▲ or ▼ Button to select the [Administration] menu, and then press the OK Button.
3. Select [ Language], scroll to select your language, and then press the OK Button.

Setting the Time and Date (QL-820NWB only)

Adjust the clock to the current time and date. The time and date set here are displayed on the main screen.

1. Press the Menu, ▲, or ▼ Button to select the [Settings] menu, and then press the OK Button.
2. Select [Set Clock] using ▲ or ▼ Button, and then press the OK Button. The clock setting screen appears.
3. Use ▲ or ▼ to specify the last two digits of the year, and then press the OK Button. Specify two digits for the month and day in the same way.

4. Use ▲ or ▼ to specify two digits each for the hours and minutes, and then select [AM], [PM] or [24].
5. Press the OK Button. The [Settings] menu is displayed.

Printing Using the Mobile Device

Installing Applications for Use with Mobile Devices

Brother offers various applications for use with your Label Printer, including applications that allow you to print directly from your Apple iPhone, iPad, and iPod touch or Android™ smartphone or tablet, and applications that allow you to transfer data wirelessly, such as templates, symbols, and databases created using a computer, to your Label Printer.

Connecting the Label Printer to a Mobile Device 3

1. Confirm the Wireless Direct settings of the Label Printer, and then connect the Label Printer to your computer using a USB cable.

Using the Label Printer (QL-820NWB only)

1. Press the Menu and ▼ Buttons to select the [WLAN] menu, and then press the OK Button. Set [WLAN (On/Off)] to [On].
2. Press the Menu and ▼ Buttons to select the [WLAN] menu, and then press the OK Button.
3. Press the ▼ Button to select the [Network Mode] menu, and then press the OK Button.
4. Select [Direct Mode], and then press the OK Button. The Wireless Direct icon appears on the LCD.

For Windows

Connect the Label Printer and computer with a USB cable. Start the Printer Setting Tool on your computer, and click [Communication Settings]. Select [Infrastructure and Wireless Direct] or [Wireless Direct] for [Selected Interface] in [Communication Settings] in the [General] tab, and confirm the [Wireless Direct] tab.

See Communication Settings for Windows on page 40 for more information on the Communication Settings.

For Mac

- a) Launch the Printer Setting Tool on your computer.
- b) Click the [Wireless LAN] tab.
- c) Confirm that [Wireless Direct] is set to [On].

2. For QL-810W

Press and hold the Wi-Fi () Button on the Label Printer for one second to turn the Wi-Fi function On. The Wi-Fi () LED starts flashing blue once every three seconds.

For QL-820NWB

Press the Menu and ▼ Buttons to select the [WLAN] menu, and then press the OK Button. Set [WLAN (On/Off)] to [On] to turn the Wi-Fi function On. The Wi-Fi () icon appears on the LCD.

3. In the Wi-Fi settings screen of your mobile device, select the SSID of the Label Printer and enter the password.

Printing from a Mobile Device

1. Make sure that the Label Printer is connected to your mobile device. Start the mobile printing application on your mobile device. See Connecting the Label Printer to a Mobile Device on page 33.
2. Select a label template or design. You can also select a previously designed label or image and print it.
3. Tap [Print] in the application menu.

Using a Mobile Device to Print Templates Created on a Computer 3

You can use P-touch Transfer Manager to save template data, which was created using P-touch Editor, in the BLF or PDZ format. Then, you can use Mobile Transfer Express to send the saved file from your mobile device to the Label Printer and print the file.

1. Save the template data in the BLF format or the PDZ format using P-touch Transfer Manager. For more information, see Creating Transfer Files and Transfer Package Files on page 133.
2. Use one of the following methods to use a .blf file or .pdz file with your mobile device.
 - Save the file using a cloud storage service, and then use the sharing function of the mobile device's operating system to share the file.
 - Send the file as an email attachment from the computer to the mobile device, and then save the file to the mobile device.
3. Connect the Label Printer to your mobile device, and then start Mobile Transfer Express. The template data appears.
4. Select the template that you want to print, and then transfer the template to the Label Printer.
5. Use the Barcode Scanner or the LCD (QL-820NWB only) to select the template that you want to print from the transferred file and print it.

Attaching Labels

1. Peel the backing from the label.
2. Position the label, and then press firmly from top to bottom with your finger to attach the label.

Printing Labels Using P-touch Template

P-touch Template Operations

The P-touch template mode allows you to insert data into text and barcode objects from a downloaded template using an optional Barcode Scanner (PA-BR-001) or other devices connected to the Label Printer.

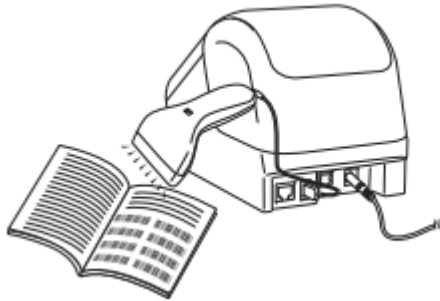

Preparation

Before connecting the Barcode Scanner to the Label Printer, specify the Barcode Scanner settings using the P-touch Template Settings (inside Printer Setting Tool).

Specifying Settings in the P-touch Template Settings Tool

1. Connect the Label Printer and the computer using a USB cable, and then turn on the Label Printer.

2. Start the Printer Setting Tool.

For Windows Vista / Windows 7 / Windows Server 2008 / Windows Server 2008 R2:
From the Start button, click [All Programs] - [Brother] - [Label & Mobile Printer] - [Printer Setting Tool].

For Windows 8 / Windows 8.1 / Windows Server 2012 / Windows Server 2012 R2:
Click the [Printer Setting Tool] icon on the [Apps] screen.

For Windows 10: From the Start button, click [Brother] - [Label & Mobile Printer] - [Printer Setting Tool].

3. Click [P-touch Template Settings].

4. Select the appropriate settings, and then click [Set].

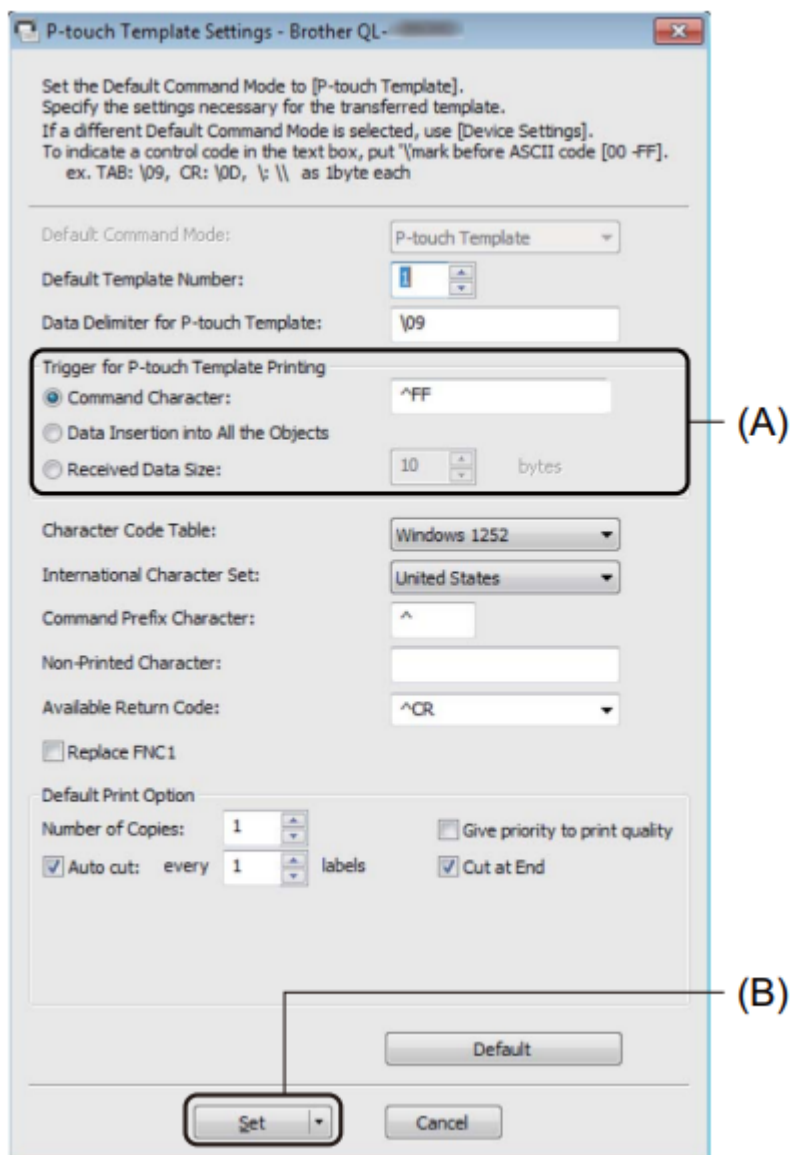

Connecting a Barcode Scanner (QL-820NWB only)

We recommend you use a reliable high-quality Barcode Scanner and you check the Barcode Scanner specifications before selecting a model.

Barcode Scanner connection methods: Use the USB Host interface or Bluetooth interface.

Recommended Barcode Scanner selection criteria:

- When using the USB host interface: HID-class models that can be identified as a keyboard (ex. optional: PA-BR-001)
- When using the Bluetooth interface: Bluetooth Ver.2.1+EDR (Class 1) models that support SPP or OPP profiles

Advanced Template Printing

Download a template and scan a barcode to print a copy or insert the scanned data into a different template.

1. Using P-touch Transfer Manager, transfer (from P-touch Editor) a template (label layout) to the Label Printer. For more information, see How to Use P-touch Transfer Manager and P-touch Library (Windows only) on page 123.



CODE128/9-digit

2. When you transfer data to [Configurations] in P-touch Transfer Manager, select the folder containing the data you want to transfer.
3. Select the transferred template and then click [Transfer] to download the template to the [Key Assign] number in the Label Printer.
4. Scan the "P-touch template command (Initialize + begin specifying settings)" barcode. For more information, see List of Barcodes for the P-touch Template Function on page 196.
5. From the list of barcodes under "Basic settings", scan each barcode to send a command or setting to the Label Printer.
6. Scan the "Select template" barcode and then scan the barcodes under "For entering numbers" with the same number (three digits) as the [Key Assign] number used for the downloaded template to be printed. The downloaded template will be automatically selected after the three digit numbers have been scanned. Example: Specify the three digit numbers by scanning the following barcodes: 7i[0][0][7], 15i[0][1][5]
7. Scan a barcode that contains the data you want inserted into the barcode object in the selected downloaded template from step 6

Example:



(CODE128/9-digit)

8. Scan the "Begin printing" barcode to send the command to start printing.
9. The barcode in the printed template will contain the data from the barcode scanned in step 7

Example:



Numbering (Serialized Number) Printing

Text Numbering (Serializing)

Procedure

1. Use P-touch Editor to create or open a template and select a text object that you want to automatically increment while printing.

Example:

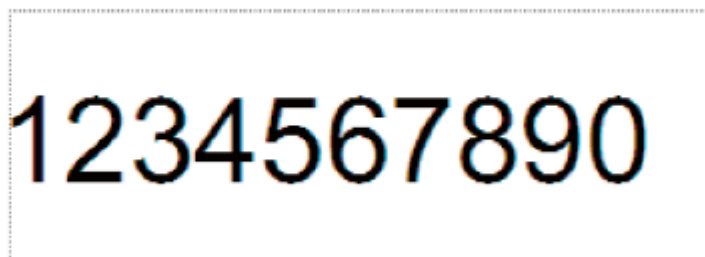

2. Highlight or drag the cursor over a group of numbers and letters within the text object that you want to increment (Numbering field).



3. With the cursor over the highlighted Numbering field, right-click and select [Numbering].

Procedure

1. Use P-touch Editor to create or open a template and select a barcode object that you want to automatically increment while printing.

2. With the cursor over a selected barcode object, right-click and select [Properties].

Example:

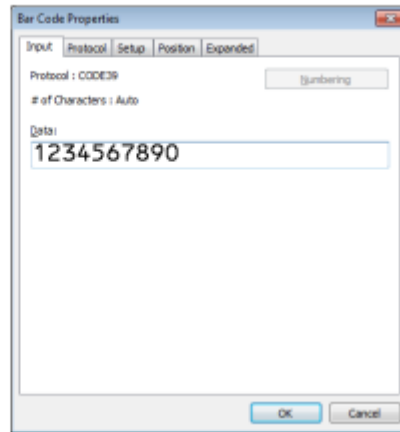

3. Click the Input tab and highlight or drag the cursor over a group of numbers and letters within the barcode object that you want to increment (Numbering field).

Example:

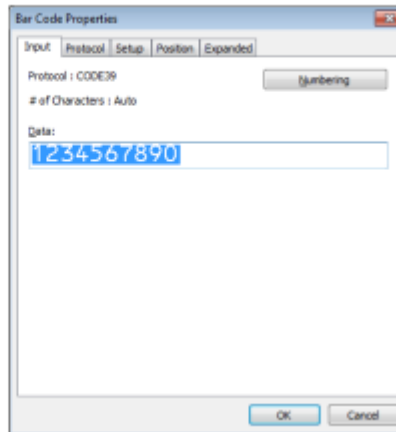

4. Click [Numbering], and then click [OK]

Printing with Numbering (Serializing) Advanced Operation

1. Using P-touch Transfer Manager, transfer (from P-touch Editor) a template (label layout) to the Label Printer. For more information, see How to Use P-touch Transfer Manager and P-touch Library (Windows only) on page 123. A linked database file will also be transferred.
2. Numbering (Serializing) advanced operation setting the Label Printer. See List of Barcodes for the P-touch Template Function on page 196.

Scan the "Number of serialized copies" barcode and then scan the barcodes under "For entering numbers" with the number of copies you want to print (three digits).

Maintenance

Cleaning the Exterior of the Unit

Wipe any dust and marks from the main unit using a soft, dry cloth.

Use a cloth slightly damp with water on difficult to remove marks

Cleaning the Print Head

The DK Roll (thermal recording paper type) used with the machine is designed to clean the print head automatically. When the DK Roll passes the print head during printing and label feeding, the print head is cleaned.

Cleaning the Roller

Clean the roller using the Cleaning Sheet (available separately).

The Label Printer contains only one Cleaning Sheet.

1. Turn off the power to the Label Printer.
2. Hold the printer by the front and firmly lift the DK Roll Compartment Cover to open it.



3.



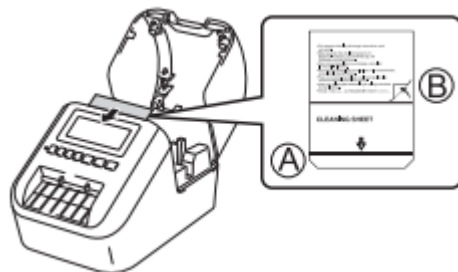

Remove the DK Roll.

4. Remove part (B) of the Cleaning Sheet. Insert edge (A) of the Cleaning Sheet into the



printing unit.

5. Close the DK Roll Compartment Cover and turn on the Label Printer.

6. Press the Feed () Button (QL-810W) or the Cutter () Button (QL-820NWB) for more than one second. The Cleaning Sheet is ejected. The adhesive side of the Cleaning Sheet removes any stains or dust on the roller.

Cleaning the Label Outlet

If a label causes the machine to jam due to adhesive residue attached to the label outlet, clean the label outlet with a cloth.

Use a slightly damp cloth on difficult to remove adhesive, if necessary.

Warning

This content is compiled from multiple sources and is provided for reference purposes only. It may not be complete or fully applicable to all situations. If you are unable to resolve your issue, please contact the product manufacturer or an authorized service provider for official support.