

USING THE REFRIGERATOR

Features



- 1 Space-saving ice maker***
Ice maker and bin are located on the door creating more usable storage space.
- 2 Showcase LED lighting**
LED lighting is positioned throughout the interior to spotlight areas in the refrigerator. LEDs are located under the fresh food door to light the freezer when opened.
- 3 Drop-down tray***
Allows for extra door storage when you need it and tucks away when you don't.
- 4 Full-width temperature controlled drawer**
Adjustable temperature control bin that can accommodate larger items.
- 5 Dairy bin**
Separate compartment for your items.
- 6 Ice bin/Ice maker***
Ice maker with ice storage bins.
- 7 QuickSpace™ shelf***
Functions as a normal full-sized shelf when needed and easily slides back to store tall items below.
- 8 Spillproof shelves**
Designed to capture your spills for easier clean up.
- 9 Anti-slip Mat**
Liner that captures spills, keeps containers from shifting when the door is opened and is easily removable for cleaning.
- 10 Removable door bin**
Can be removed for those with a wall limiting the door opening.
- 11 Climate zone bin**
Separate bins for produce storage.
- 12 Water filter**
Filters water and ice.

1. Door ice bin*

1. Open left fresh food door.
2. Pull down latch to release bin door.
3. Using handhold lift ice bucket up and out to clear locators in bottom of bin.

4. To replace the ice bucket, set it on the guide brackets and push until the ice bucket seats properly.
5. If bucket cannot be replaced, rotate the Ice Bucket Fork 1/4 turn clockwise.

2. Drop down dairy bin*

1. Open right fresh food door.
2. Depress both buttons on lower sides and bin will drop down.
3. Reverse to reinstall.



3. Ice/water filter

Remove filter/bypass plug Push the indent on the cover and open filter door. If your unit is equipped, pull out on filter/ bypass plug and pull straight back to remove.

Installing the filter cartridge Push the indent at the bottom of the cover and open. Lift door and align tabs on filter to filter/holder and push filter into place.

NOTE: Certified to reduce chlorine-resistant cysts, lead, select pharmaceuticals, and more.

WARNING Scalding Hazard.*

Use of the hot water dispenser prior to purging air from the system may result in spurting of hot water and lead to hot water scalding. Follow the instructions for "Water Filter- Step 3" on page 16 to purge all air from the system through the cold water dispenser prior to using the hot water dispenser. **The first time the hot water feature is used, confirm if you live above 5000 feet**

(1524 meters) (high altitude). This limits the temperature of the hot water system to avoid boiling. To access the high altitude selection, see CYE/CFE Control Style.



Controls

CYE/CFE Control Style



Changing the Temperature for Control Style CYE/CFE

To Change the Refrigerator Temperature:

Access By: Temperature Button



Activate By: to select the desired temperature. Press DONE when finished to return to HOME screen.

To Change the Freezer Temperature:

Access By: Temperature Button



Activate By: Below the word “Freezer”, use the arrows to select the desired temperature. Press **DONE** when finished to return to **HOME** screen.

To turn OFF cooling system, access **SETTINGS** from the **HOME** screen. Page over and tap **COOLING SYSTEM ON**. Press **DONE** to return to HOME screen. To turn ON cooling system, access **SETTINGS** from the HOME screen. Page over and tap **COOLING SYSTEM OFF**. Press **DONE** to return to HOME screen. Turning the cooling system off stops the cooling to refrigerator, but it does not shut off the electrical power.

NOTE: For optimal temperature performance, we recommend to avoid placing food or other items directly at the air flow vents or the fresh food air tower, thus blocking the air flow

CWE Control Style





Changing Temp. for Control Style CWE

Temperature Display is located on inside of left-hand refrigerator door. **To change the temperature**, press and release the REFRIGERATOR or FREEZER pad. The ACTUAL TEMP light will come on and the display will show the actual temperature. To change the temperature, tap either the REFRIGERATOR or FREEZER pad until the desired temperature is displayed. To turn OFF cooling system, press and hold the REFRIGERATOR and FREEZER pads simultaneously for 3 seconds. When the cooling system is OFF the display should read OFF. To turn ON cooling system, press either REFRIGERATOR or FREEZER pad. The display will show the preset temperature settings of 37°F (3°C) for refrigerator and 0°F (-18°C) for freezer. Turning the cooling system off stops the cooling to refrigerator, but it does not shut off the electrical power.

Control Style A, External Controls CFE/CYE Models





NOTE: The refrigerator is shipped with protective film covering the temperature controls. If this film was not removed during installation, remove it now.

The temperature controls are preset in the factory at 37°F for the refrigerator compartment and 0°F for the freezer compartment. Allow 24 hours for the temperature to stabilize to the preset recommended settings.

The temperature controls can display both the SET temperature as well as the actual temperature in the refrigerator and freezer. The actual temperature may vary slightly from the SET temperature based on usage and operating environment.

1. **Hot Water** Dispenses up to 10 ounces of filtered hot water from user selected ranges of 90°F to 185°F.
2. **Hot Water Knob** Illuminates to indicate hot water is ready. Dispenses with two motions: a counter-clockwise twist and then push to dispense.
3. **Precise Fill** Precisely dispenses filtered water in accurate measurements in ounces, cups, quarts, or liters using paddle.
4. **Refrigerator temp control** Adjust freezer compartment temperature.
5. **Fresh food temp control** Adjust fresh food compartment temperature.
6. **TurboFreeze™ setting** Activate TurboFreeze to quickly restore freezer temperatures after frequent door openings.
7. **TurboCool™ setting** Activate TurboCool to quickly restore fresh food temperature after frequent door openings.
8. **Humidity setting** Humidity setting can be normal or high.
9. **Lock controls** Press and hold 3 seconds to lock out ice and water dispenser and all feature and temperature buttons

10. **LED dispenser light** LED lighting that can be turned on/off to light your dispenser.

11. **Photo Upload** Insert USB memory stick to upload personal photos to the refrigerator LCD screen. LCD will provide on screen prompts to load and view slideshow. Make sure the photos are in the root directory in your USB.

12. Additional Settings

- Connected Home ready
- Slideshow
- et filter
- Ice maker on/off
- Door alarm
- Sound control
- Cooling system On/Off
- Metric/English units
- Altitude

Additional Modes

- **Sabbath Mode**

Press and hold lock & light simultaneously for 3 seconds to enter/exit Sabbath mode. Sabbath Mode will turn off or dim interior lights, temperature control and advanced features. Compressor will run on a timed defrost when in Sabbath mode.

Controls Style B, Internal Controls CWE Models



1 Door Alarm
Sounds to alert when the freezer or fresh food doors have been left open.

2 Reset Filter
Hold for 3 seconds after replacing filter.

3 Lock Controls
Press and hold 3 seconds to lock out ice and water dispenser and all feature and temperature buttons.

4 Freezer temp control
Adjust freezer compartment temperature

5 Refrigerator temp control
Adjust fresh food compartment temperature

6 Ice maker setting
Turn your ice makers on/off.

7 Sabbath Mode
Press and hold Door Alarm and Ice Maker simultaneously for 5 seconds to enter/exit Sabbath Mode.

Dispenser (CFE & CYE Models Only)



WARNING: LACERATION HAZARD

- Never put fingers or any other object into ice crusher discharge opening. Doing so can result in contacting the ice crushing blades and lead to serious injury or amputation
- Use a sturdy glass when dispensing ice. A delicate glass may break and result in personal injury.

If no water is dispensed when the refrigerator is first installed, there may be air in the water line system. Press the dispenser paddle for at least five minutes to remove trapped air from the water line and to fill the water system. To flush out impurities in the water line, throw away the first six full glasses of water.

To remove Dispenser Tray

- Pull Dispenser Tray out until it stops.
- Locate tab in the center on the bottom and push up.

- Pull Dispenser Tray assembly out.
- Lift metal Dispenser Tray out at center notch to clean.

To reinstall Dispenser Tray

- Place the Dispenser Tray cover on top of catch tray and position under the two plastic retainers on either side.
- Center Dispenser tray, and align with center guides.
- Push in until is firmly in place

Important Facts About Your Dispenser

- Do not add ice from trays or bags to the door ice maker bucket. It may not crush or dispense.
- Avoid overfilling glass with ice and use of narrow glasses. Backed-up ice can jam the chute or cause the door in the chute to freeze shut. If ice is blocking the chute remove the ice bucket, poke it through with a wooden spoon.
- Beverages and foods should not be quick-chilled in the door ice maker bin. Cans, bottles or food packages in the storage drawer may cause the ice maker or auger to jam.
- To keep dispensed ice from missing the glass, put the glass close to, but not touching, the dispenser opening. √ Some crushed ice may be dispensed even though you selected CUBED ICE. This happens occasionally when a few cubes accidentally get directed to the crusher.
- After crushed ice is dispensed, some water may drip from the chute.
- Sometimes a small mound of snow will form on the door in the ice chute. This condition is normal and usually occurs when you have dispensed crushed ice repeatedly. The snow will eventually evaporate.

To Use the Internal Water Dispenser (CWE Models Only)



The water dispenser is located on the left wall inside the refrigerator compartment.

To dispense water:

1. Hold the glass against the recess.
2. Push the water dispenser button.
3. Hold the glass underneath the dispenser for 2–3 seconds after releasing the dispenser button. Water may continue to dispense after the button is released.

If no water is dispensed when the refrigerator is first installed, there may be air in the water line system. Press the dispenser button for at least 5 minutes to remove trapped air from the water line and to fill the water system. During this process, the dispenser noise may be loud as the air is purged from the water line system. To flush out impurities in the water line, throw away the first 6 glassfuls of water.

NOTE: To avoid water deposits, the dispenser should be cleaned periodically by wiping with a clean cloth or sponge.

Water Filter Cartridge - RPWFE

Water Filter Cartridge The water filter cartridge is located in the fresh food interior on the left side wall, near the top. Select models use radio frequency identification (RFID) to detect leaks and monitor filter status. The RFID technology is certified by the FCC.

FCCID: ZKJ-EBX1532P001 ICID: 10229A-EBX1532P001 “This device complies with part 15 of the FCC Rules. Operation is subject to the following two conditions: (1) This device may not cause harmful interference, and (2) this device must accept any interference received, including interference that may cause undesired operation.”

“This device complies with Industry Canada licence exempt RSS standard(s). Operation is subject to the following two conditions: (1) this device may not cause interference, and (2) this device must accept any interference, including interference that may cause undesired operation of the device.

When to Replace the Filter Cartridge

The filter cartridge should be replaced every six months or earlier if 170 gallons (643.52 liters) of water has been dispensed or the flow of water to the dispenser or icemaker decreases.

Touch Screen Models: A filter status message will appear on the screen when the water filter needs to be replaced. The filter status will automatically update when the filter is replaced.

Non-touch Screen Models:

A filter indicator light will illuminate on the screen when the water filter needs to be replaced.

Removing the Filter Cartridge/Bypass Plug



1. Remove the old cartridge or bypass plug by opening the filter door and pulling on the bottom of the cartridge/ bypass plug to disengage it from the filter clips. Swing the cartridge/bypass plug outward until you hear the 'click' of the cartridge holder engaging with the bracket.
2. Twist the cartridge/bypass plug one-quarter turn counter-clockwise. After twisting, remove the cartridge/ bypass plug by pulling it away from the cartridge holder. A small amount of water may drip out.

Installing the Filter Cartridge/Bypass Plug

1. Align the filter cartridge/bypass plug with the cartridge holder with the word "FRONT" facing the top of the unit. Push the cartridge/bypass plug toward the rear of the unit until it is fully seated. Twist the filter cartridge/ bypass plug clockwise one-quarter turn, until the word "FRONT" is facing outward



2. While continuing to ensure cartridge/bypass plug is fully seated in the holder, gently swing the filter inward until it is in position. If filter will not swing easily, check to ensure filter is properly aligned and fully seated within the cartridge holder. The RED indicators should not be visible.

NOTE: It is normal for water to appear discolored during the initial system flush. Water color will return to normal after first few minutes of dispensing.

Filter Bypass Plug

To reduce the risk of property damage due to water leakage, you **MUST** use the filter bypass plug when a replacement filter cartridge is not available. Some models do not come equipped with the filter bypass plug. To obtain a free bypass plug, visit us on-line at cafeappliances.com/service. In Canada, visit cafeappliances.ca/service. The dispenser and icemaker will not operate without either the filter or the bypass plug installed. The bypass plug is installed in the same way as a filter cartridge.*

WARNING: SCALDING HAZARD

Use of the hot water dispenser prior to purging air from the system may result in spurting of hot water and lead to hot water scalding. Follow the instructions above to purge all air from the system through the cold water dispenser prior to using the hot water dispenser.

WARNING To reduce the risk associated with choking, do not allow children under 3 years of age to have access to small parts during the installation of this product. The disposable filter cartridge should be replaced every 6 months at the rated capacity, or sooner if a noticeable reduction in flow rate occurs.

For the maximum benefit of your filtration system, GE Appliances, a Haier company, recommends the use of GE Appliances-branded filters only. Using GE Appliances-branded filters in Cafe refrigerators provides optimal performance and reliability. Our filters meet rigorous industry NSF standards for safety and quality that are important for products that are filtering your water. There is no assurance that brands other than GE Appliances filters meet our standards for quality, performance and reliability.

If you have questions, or to order additional filter cartridges, visit gewaterfilters.com. In Canada, visit cafeappliances.ca/service or consult the yellow pages for the nearest Camco Service Center.

Hot Water

Hot Water Only Models



Important Facts about HOT WATER

To Use Hot Water Dispenser

- Press HOT WATER button.
- Select desired water temperature on the LCD screen (90, 150, 170, 185, or Custom).
- When hot water is ready (indicated on the screen and by a beeping sound) hold container with left hand centered in the recess **under the spout**.
- To dispense water, rotate the hot water knob counterclockwise and then push it in. The knob must be held in during dispense

WARNING: SCALDING HAZARD.

- The water coming from the dispenser is very hot and can cause scalds or burns. Read all warnings on page 5 prior to use.
- Always use a container that is suitable for hot liquids (ceramic, foam, etc.)
- The maximum single hot water dispense amount is 10 oz. Additional hot water can be dispensed by restarting the hot water feature through the LCD screen.
- HOT WATER works best with household water pressure of 40 to 100 psi.
- HOT WATER will time out if unused and may require a short reheat time.

For Models with K-Cup Brewing System



On Café refrigerators equipped with the K-Cup brewing system, ALL HOT WATER is dispensed from stainless steel dispense tube located under the right side of the control panel. The hot water is not dispensed from the center of the recess area.

To Use Hot Water Dispenser

- Press HOT WATER button.
- Select desired water temperature on the LCD screen (90, 150, 170, 185, or Custom).*
- *If selecting "Keurig K-Cup Pod", the hot water system will change into K-Cup mode. See page 14 for K-Cup mode instructions.
- When hot wa ter is ready (indicated on the screen and by a beeping sound) hold container with left hand centered in the recess under the spout.
- To dispense water, rotate the hot water knob counterclockwise and then push it in. The knob must be held in during dispense.

WARNING Scalding Hazard

- See Hot Water Warning: Scalding Hazard above.
- Do no permit children to use the brewer.
- Always use a container that is suitable for hot liquids (ceramic, foam, etc.) Ÿ Do not brew into a mug made of glass. Doing so may cause the glass to crack or break.

Single Serve Keurig K-Cup Brewer

How to use the single serve dispenser

1. Load Keurig K-Cup into brewer.



CAUTION Cut/Puncture Hazard.

- There are two sharp needles located inside the K-Cup brewer. To avoid risk of injury, do not put your fingers inside the brewer. Use caution when cleaning.
- Keep the K-Cup brewer out of the reach of children, as they may be injured in using the K-Cup brewer incorrectly.

2. Two ways to brew:

1. Press Hot Water. Select K-Cup Pod. OR
2. Slide the brewer into the rails



3. Pick your size.



NOTICE: If using a powdered beverage, select the Cocoa setting.

4. Place your mug under the brewer (on the tray mug icon and under the red brew spout).

NOTICE: Make sure the mug being used is large enough for the size selected.



5. Rotate the hot water knob counterclockwise and push in to brew and dispense.

NOTICE: Press any button or dispenser paddle, or open either the left or right door to cancel dispense.



Cleaning the brewer

- The K-Cup brewer is dishwasher safe. To clean it, open the lid and place the K-Cup brewer in the top rack of your dishwasher and run in a normal wash cycle.
- To maximize performance of your brewer, it is recommended to rinse it thoroughly after washing to remove all soap residue.
- Periodic cleaning of dispenser recess area is recommended as staining may occur with usage of the K-Cup brewer.



Appliance Communication

WiFi Connect (for customers in the United States, its territories, and Canada) WiFi Connect Enabled*

If your refrigerator has a Connected Appliance information label located on the inside as shown, your refrigerator can be connected to your WiFi network, allowing it to communicate with your smart phone for remote monitoring, control and notifications. Depending on the refrigerator model you have, you either have a WiFi communication card built into the product, or a port for an external WiFi ConnectPlus Module (sold separately). Please visit cafeappliances.com/connect to learn more about connected appliance features, and to learn what connected appliance apps will work with your Smart Phone.



REGULATORY INFORMATION FCC/IC Compliance Statement:

This device complies with Part 15 of the FCC Rules. Operation is subject to the following two conditions:

1. This device may not cause harmful interference, and
2. This device must accept any interference received, including interference that may cause undesired operation.

This equipment has been tested and found to comply with the limits for a Class B digital device, pursuant to Part 15 of the FCC Rules. These limits are designed to provide reasonable protection against harmful interference in a residential installation. This equipment generates uses and can radiate radio frequency energy and, if not installed and used in accordance with the instructions, may cause harmful interference to radio communications. However, there is no guarantee that interference will not occur in a particular installation. If this equipment does cause harmful

interference to radio or television reception, which can be determined by turning the equipment off and on, the user is encouraged to try to correct the interference by one or more of the following measures:

- Reorient or relocate the receiving antenna.
- Increase the separation between the equipment and receiver.
- Connect the equipment into an outlet on a circuit different from that to which the receiver is connected.
- Consult the dealer or an experienced radio/television technician for help.

Labelling: Changes or modifications to this unit not expressly approved by the manufacturer could void the user's authority to operate the equipment.

Fresh Food Storage Options

Rearranging the Shelves

Shelves in the refrigerator compartment are adjustable.

To remove:

1. Remove all items from the shelf.
2. Tilt the shelf up at the front.
3. Lift the shelf up at the back and bring the shelf out.



To replace:

1. While tilting the shelf up, insert the top hook at the back of the shelf in a slot on the track.
2. Lower the front of the shelf until the bottom of the shelf locks into place.



Spillproof Shelves

Spillproof shelves have special edges to help prevent spills from dripping to lower shelves.



Quick Space Shelf *

This shelf splits in half and slides under itself for storage of tall items on the shelf below. This shelf can be removed and replaced or relocated (just like spillproof shelves).

NOTE: The back half of the Quick Space Shelf is not adjustable.



Non-Adjustable Dairy Bin*

To remove: Lift the dairy bin straight up, then pull out.

To replace: Engage the bin in the molded door supports and push down. The bin will lock in place.
See page 36.



Fresh Food Storage Options

Adjustable Bins on the Door

Adjustable bins can easily be carried from refrigerator to work area.

To remove: Lift bin straight up, then pull out.

To replace or relocate: Slide in the bin just above the molded door supports, and push down. The bin will lock in place.



Drop down tray * (tray open) 1. Open right fresh food door 2. Depress both buttons on lower sides of bin and bin will drop down. 3. Reverse to reinstall.

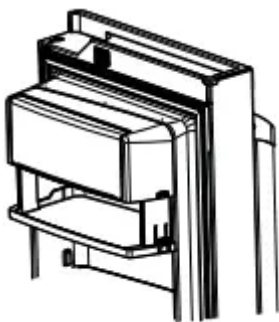

Non-Adjustable Bins on the Door (Dispenser Models - Left Hand Door)

To remove: Lift the bin straight up, then pull out.

To replace: Engage the bin in the molded supports on the door and push down. It will lock in place. The ice maker door bins are not interchangeable, note the location upon removal and replace the bin in its proper location.



Non-Dispense Models (Left Hand Door)



Climate Zone & Temperature Controlled Drawer

ClimateZone

Keep fruits and vegetables organized in separate compartments for easy access. Excess water that may accumulate in the bottom of the drawers or under the drawers should be wiped dry.

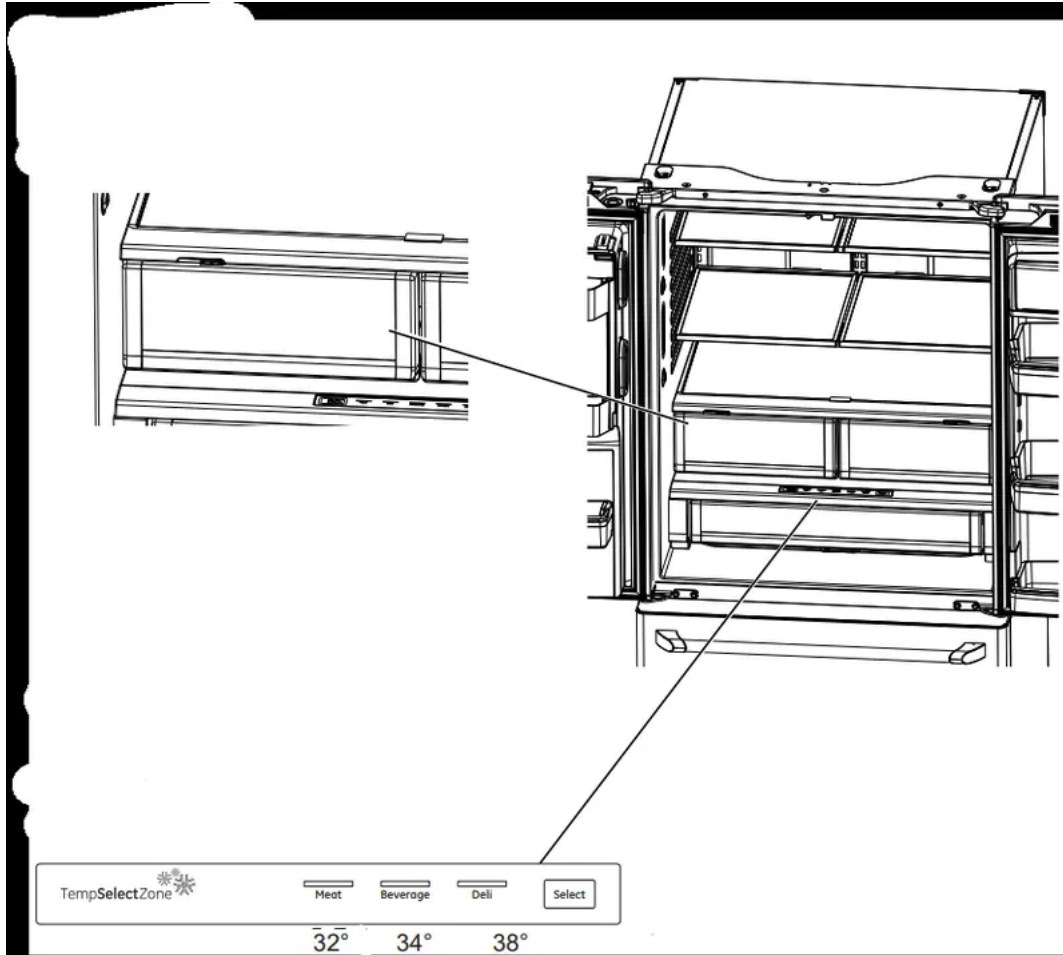

CAUTION Laceration Hazard.

Do not store glass bottles at this setting. If they are frozen, they can break and result in personal injury.

Temperature Controlled Drawer

The Temperature Controlled Drawer is a full-width drawer with adjustable temperature control. This drawer can be used for large miscellaneous items. To change setting, press select button.

NOTE: Temperatures indicate the appropriate temperatures for the food and actual temperatures may vary based on normal operation and other factors such as door openings and fresh food set point.

How to Remove and Replace Drawer

To remove:

1. Pull the drawer out to the stop position.
2. Lift the front of the drawer up and out.

To replace:

1. Pull left and right slides until fully extended.
2. Place drawer back in first and rotate drawer front down to seat on slide.
3. Push the drawer in to closed position.

**How to Remove and Replace Drawer Divider*****To remove:**

1. Pull the drawer out to the stop position.
2. Slide pan divider to right to release it from pan.

To replace:

Reverse steps 1 and 2 to replace drawer divider



Baskets, Drawers, and Bins

Freezer Basket and Drawer

1. Basket
2. Drawer
3. Ice Bucket*



Non-Adjustable Bin in the Freezer

To remove: Push in plastic tab on either left or right side.

To replace: Slide bin into location until it locks into place.



Basket Removal

To remove, CFE only:

1. Open freezer door to the stop position.
2. Remove freezer door bin by pushing plastic tab on either left or right side to release bin hinge pin.
3. Remove freezer basket by lifting up the rear of the basket and moving basket rearward until the front of the basket can be rotated upward and out.
4. Lift it out to remove.

To remove, CYE and CWE only:

1. Open fresh food doors.
2. Open freezer door to the stop position.
3. Remove freezer basket by lifting up the rear of the basket and rotate it upward.
4. Lift it out to remove.

To replace:

Reverse step 1 thru 4 to replace.



Automatic Ice Maker

A newly installed refrigerator may take 12 to 24 hours to begin making ice

WARNING Connect to potable water supply only. A cold water supply is required for automatic icemaker operation. The water pressure must be between 40 and 120 psi (275-827 kilopascals)

Automatic Ice maker*

The ice maker will produce seven cubes per cycle approximately 100–130 cubes in a 24-hour period, depending on freezer compartment temperature, room temperature, number of door openings and other use conditions.

The ice maker will fill with water when it cools to 15°F (–10°C). A newly installed refrigerator may take 12 to 24 hours to begin making ice cubes.

If the refrigerator is operated before the water line connection is made to the unit or if the water supply to an operating refrigerator is turned off, make sure that the ice maker is turned off. Once the water has been connected to the refrigerator, the ice maker may be turned on. See the table below for details.

You may hear a buzzing sound each time the ice maker fills with water. Throw away the first few batches of ice to allow the water line to clear.



Be sure nothing interferes with the sweep of the feeler arm. When the bin fills to the level of the feeler arm, the ice maker will stop producing ice. It is normal for several cubes to be joined together. If ice is not used frequently, old ice cubes will become cloudy, taste stale and shrink. NOTE: In homes with lower-than-average water pressure, you may hear the ice maker cycle multiple times when making one batch of ice. **CAUTION** To minimize the risk of personal injury, avoid contact with the moving parts of the ejector mechanism, or with the heating element that releases the cubes. Do not place fingers or hands on the automatic ice making mechanism while the refrigerator is plugged in.

How to Turn the Ice Maker On/Off

Display Type (See Page 8)	Model #	How to turn the ice maker on/off
Control Style A	CYE/CFE	Use the settings menu on the touchscreen
Control Style B	CWE	Use the "ICE MAKER" button on the control

Ice Bucket and Dispenser*

- Open the ice box door on inside of the left door.
- Pull up and out on the ice bucket in the left hand door to remove it from the compartment.
- To replace the ice bucket, set it on the guide brackets and push until the ice bucket seats properly.
- If bucket cannot be replaced, rotate the ice bucket fork 1/4 turn clockwise.



Freezer Ice Bucket*

The ice storage is in the freezer compartment drawer.

- Open the freezer drawer.
- The ice bucket is located on the left side of the upper basket.
- Pull the upper basket forward to remove the ice bucket



Care and Cleaning

Cleaning the Outside

Directions for Cleaning Outside Surfaces, Door Handles, and Trim

DO USE

- Soft, clean cloth or sponge
- Mild detergent mixed with warm water Approved stainless steel cleaners; Visit the Café Appliances parts store for approved stainless steel cleaners: cafeappliances.com/parts.
- Cleaners with oxalic acid such as Bar Keepers Friend Soft Cleanser™ can be used to remove surface rust, tarnish and small blemishes on stainless steel surfaces only

DO NOT USE

- Abrasive cloths, scrubbing sponges, scouring or steel wool pads
- Abrasive powders or sprays
- Window Sprays or Ammonia
- Citrus or plant oil-based cleaners
- Acidic or vinegar-based cleaners
- Oven cleaners
- Cleaners containing acetone (propanone)
- Any cleaner with WARNING about plastic contact

NOTE: DO NOT allow stainless steel cleaner to come in contact with any plastic parts such as trim pieces, handle hardware and liners. If unintentional contact of cleaners with plastic parts does occur, clean plastic part with a sponge and mild detergent mixed with warm water.

Cleaning the Inside

Unplug the refrigerator before cleaning.

If this is not practical, wring excess moisture out of sponge or cloth when cleaning around switches, lights or controls.

Use an appliance wax polish on the inside surface between the doors.

Use warm water and baking soda solution - about a tablespoon (15 ml) of baking soda to a quart (1 liter) of water. This both cleans and neutralizes odors. Rinse and wipe dry.

CAUTION Do not clean glass shelves or covers with warm water when they are cold. Glass shelves and covers may break if exposed to sudden temperature changes or impact such as bumping or dropping. Tempered glass is designed to shatter into many small pieces if it breaks. Do not wash any plastic refrigerator parts in the dishwasher.

Behind the Refrigerator

Be careful when moving the refrigerator away from the wall. All types of floor coverings can be damaged, particularly cushioned coverings and those with embossed surfaces.

Raise the leveling legs located at the bottom front of the refrigerator.

Pull the refrigerator straight out and return it to position by pushing it straight in. Moving the refrigerator in a side direction may result in damage to the floor covering or refrigerator. Lower the leveling legs until they touch the floor.

WARNING ELECTRICAL SHOCK HAZARD

When pushing the refrigerator back, make sure you don't roll over the power cord or water supply line.

Preparing for Vacation

For long vacations or absences, remove food and unplug the refrigerator. Clean the interior with a baking soda solution of one tablespoon (15 ml) of baking soda to one quart (1 liter) of water. Leave the doors open.

LCD Models: turn refrigerator off at control . If the temperature can drop below freezing, have a qualified service technician drain the water supply system to prevent serious property damage due to flooding.

1. Turn refrigerator off or unplug the refrigerator.
2. Empty ice bucket
3. Turn water supply off

If you cut the water supply off, turn off the ice maker.

Upon returning from vacation:

1. Replace the water filter.
2. Run 2 gallons (7.57 liters) of water through the cold water dispenser (about 5 minutes) to flush the system.
3. Dispense 185°F (85°C) hot water 3 times (10 oz. each) to flush the system.

Preparing to Move

Secure all loose items such as shelves and drawers by taping them securely in place to prevent damage. When using a hand truck to move the refrigerator, do not rest the front or back of the refrigerator against the hand truck. This could damage the refrigerator. Handle only from the sides of the refrigerator. Be sure the refrigerator stays in an upright position during moving.

Refrigerator Lights (LEDs)

There is LED lighting in fresh food compartment and on the bottom of the fresh food doors to light the freezer compartment. An authorized technician will need to replace the LED light.



Installation Instructions

Bottom Freezer Refrigerator

BEFORE YOU BEGIN

Read these instructions completely and carefully.

WARNING Tip Over Hazard.

Built-in style models (model CYE and CWE) are top heavy, especially with any doors open. These models must be secured with the anti-tip floor bracket to prevent tipping forward, which could result in death or serious injury. Read and follow the entire installation instructions for installing the anti-tip floor bracket packed with your refrigerator.

- **IMPORTANT** — Observe all governing codes and ordinances. Save these instructions for local inspector's use.
- Note to Installer – Be sure to leave these instructions with the Consumer.
- Note to Consumer – Keep these instructions for future reference.
- Skill level – Installation of this appliance requires basic mechanical skills.
- Completion time – Refrigerator Installation can vary Water Line Installation 30 minutes
- Proper installation is the responsibility of the installer.
- Product failure due to improper installation is not covered under the Warranty.

PREPARATION

MOVING THE REFRIGERATOR INDOORS

If the refrigerator will not fit through a doorway, the refrigerator door and freezer drawer can be removed.

- To remove the refrigerator door, see the Installing the Refrigerator section.
- To remove the freezer drawer, see the Removing the Freezer Drawer section.

WATER SUPPLY TO THE ICE MAKER AND DISPENSER

If the refrigerator has an ice maker, it will have to be connected to a cold water line. A Café water supply kit (containing tubing, shutoff valve, fittings and instructions) is available at extra cost from your dealer, by visiting our website at cafeappliances.com/parts. In Canada, visit cafeappliances.ca/parts.

TOOLS YOU MAY NEED



DIMENSIONS

All measurements are given with leveling leg fully retracted.



MOVING THE REFRIGERATOR

- Using the chart below determine if the width of your passageway can accommodate the depth of the refrigerator. Ensure you have clearance to prevent damage to the refrigerator before safely moving it to the final location.
- If passageways are large enough to accommodate the refrigerator without removing the handles skip to Step 6. Leave tape, film and all packaging on doors until the refrigerator is in the final location.
- **NOTE: Use a padded hand truck or moving straps to move this refrigerator. Place the refrigerator on the hand truck with a side against the truck. We strongly recommend that two people move and complete this installation.**

If your model number starts with CFE



If your model number starts with CYE, CWE



INSTALLING THE REFRIGERATOR

REFRIGERATOR LOCATION

- Do not install the refrigerator where the temperature will go below 60°F (16°C) because it will not run often enough to maintain proper temperatures.
- Do not install the refrigerator where the temperature will go above 100°F (37°C) because it will not perform properly.
- Do not install the refrigerator in a location exposed to water (rain, etc.) or direct sunlight.
- Install it on a floor strong enough to support it fully loaded.

CLEARANCES

Allow the following clearances for ease of installation, proper air circulation and plumbing and electrical connections.

Sides 1/8 (3mm)

Top 1"(25mm) Cabinet/Hinge Cover

Back 2"(50 mm)

REMOVING THE REFRIGERATOR DOORS

- **IMPORTANT NOTE:** This refrigerator is 36 1/4" deep (36 1/4" for CYE models). Doors and passageways leading to the installation location must be at least 36 1/4" wide in order to leave the doors and handles attached to the refrigerator while transporting it into the installation location. If passageways are less than 36 1/4" , the refrigerator doors and handles can easily be scratched and damaged. The top cap and doors can be removed to allow the refrigerator to be safely moved indoors. If passageways are less than 36 1/4" , start with Step 1.
- If it is not necessary to remove doors, skip to Step 11. Leave tape and all packaging on doors until the refrigerator is in the final location.
- **NOTE:** Use a padded hand truck to move this refrigerator. Place the refrigerator on the hand truck with a side against the truck. We strongly recommend that TWO PEOPLE move and complete this installation.

1. REMOVE THE FRESH FOOD DOOR HANDLE

Handle Design varies based on models, however Installation is same.

Stainless steel and plastic handles: Loosen the set screws with the 1/8" Allen wrench and remove the handle.

NOTE: If the handle mounting fasteners need to be tightened or removed, use a 1/4" Allen wrench.



2. REMOVE THE FREEZER DOOR HANDLE

Handle Design varies based on models, however Installation is same.

Stainless steel and plastic handles: Loosen the ste screws with 1/8" Allen wrench and remove the handle.

NOTE: If the handle mounting fasteners need to be tightened or removed, use a 1/4" Allen wrench.



Reinstall the handles using the same procedure as removing.

3. REMOVE THE REFRIGERATOR DOORS

WARNING Follow all steps for removing and reinstalling the door. Failure to follow these instructions, leaving off parts, or overtightening screws, can lead to the door falling off and result in injury and property damage.

A Securely tape the door shut with masking tape or have a second person support the door.



B Start with left-hand door first: Remove the hinge cover on top of the left refrigerator door by removing all hex screws and pulling it up. Do the same for the right-hand door and the middle cover



C Disconnect both electrical connectors at the top cover. Remove the 1/4" hex head screw to disconnect the ground wire from the hinge. Remove the 1/4" from hex head screw to remove the strain relief from the water line.



D Disconnect the water line from the back of the unit by pressing down on the dark grey collar while pulling up on the water line. Pull waterline through case conduit from the top to free the line

for door removal. The water line is more than 4' long and may need to be taped to Door for accessibility when reinstalling.



E Using a 3/8" socket ratchet/driver, screws securing the top hinge to the cabinet, then lift the hinge straight up to free the hinge pin from the location in the top of the door.



CAUTION Lifting Hazard.

Single person lift could cause injury. Use assistance when handling, moving or lifting the refrigerator doors.

NOTE: when removing door, to prevent damage to door and electronics, carefully place the door in a proper location.

NOTE: The lower door hinge pin and hinge are keyed and must be matched correctly for the door to self close properly. Please follow the directions carefully.

NOTE: for proper installation later, please follow the next step carefully.

F Fresh Food doors to be REMOVED and INSTALLED opened at 90° with case front.



REMOVE OPPOSITE DOOR

Follow the same procedure on the opposite door. There are no wires or water lines on the opposite side

4. REMOVE CENTER HINGE (if necessary)

Remove the 3/8" screws securing the center hinge to the cabinet. Use T20 driver to remove outboard screw.



5. REINSTALLING THE REFRIGERATOR DOORS

Reverse steps 1 through 4 to reinstall refrigerator, follow details below for critical alignments.

A Reinstall center hinge first and torque the screws to 65 in-lb (7.34 N-m). With the LH door at 90° to the front of the case, lower the refrigerator door onto the center hinge. Ensure that the door and hinge align correctly.



B Rotate doors closed and make sure moveable center sealing portion of the door aligns with the striker. If the door will not self-close after reinstalling, remove door, turn door upside down, check alignment mark and arrow; (there is an alignment mark on the door closure mechanism It corresponds to an alignment mark on the bottom end cap. Rotate door closure mechanism to align mark and arrow, reinstall door).



If door cannot be installed at 90° follow steps below:

1. If space or model limits opening door to less than 180°, then:
 - a) Remove door, carefully turn door upside down.
 - b) Check alignment of door closure mechanism shaft on underside of door. The flats on the shaft should correspond to alignment tab on plastic ring or mark on bottom end cap.
 - c) If shaft is not aligned to tab/mark, using 5/32" Allen wrench, rotate door closure mechanism shaft counterclockwise for right door and clockwise for left door. Then align flat with tab/mark.
 - d) Install the door at 90°.

Securely tape the door shut with masking tape or have a second person support the door. Reinstall the top hinge and torque the screws to 65 in-lb (7.34 N-m).

C Be sure to reinstall the ground wire and strain relief to the top hinge.

D Reinstall the hinge cover. **NOTE:** Ensure wires are not pinched or under screw bosses before tightening screws.

6. REMOVE THE FREEZER DOOR

A Pull the freezer door open to full extension.

B Remove 3 attachment screws, located at the bottom on each side of the freezer door using 3/8" hex socket driver.



CAUTION Lifting Hazard

Freezer door is heavy Use both hands to secure the door before lifting.

C Lift the freezer door to disengage it from the slide mechanism



The door can safely rest on the bottom. Do not rest the door on any other surfaces to avoid scratches. Push the slide mechanism back completely until it self retracts.

7. REPLACING THE FREEZER DOOR

A Pull the slide Mechanism to full extension using both hands simultaneously.



B Remove the basket resting on the slides



CAUTION Lifting Hazard

Freezer door is heavy Use both hands to secure the door before lifting.

C Lift the freezer door and place it on the slide mechanism



D Replace the attachment screws and torque the screws to 65 in-lb (7.34 N-m).

E For adjusting freezer door gaps, follow the instructions on pg 30.

F Replace the basket

Instructions for adjusting freezer door gaps:

IMPORTANT!



The 6 mounting screws (3 on each side) are NOT interchangeable with the center or top hinge screws. Drawer screws have flat washer heads, and other screws have lines/ribs on washer heads.

After installation of the freezer door, check for uniform gaps (top and bottom of right and left hand side) with the template provided.

In the event of excessive gaps use the following steps to adjust the freezer door.

Step 1 - Loosen the 3 screws on each side (right and left) of the freezer door.

Step 2 - Adjust set screw clockwise if gap at the top is too big (see template). Turn the set screw using 3/32" hex key clockwise by quarter to half a rotation

Step 3 - Adjust set screw counter-clockwise if gap at the bottom is too big (see template). Turn the set screw using 3/32" hex key counter-clockwise by quarter to half a rotation.

Step 4 - Tighten the 3 screws on each side (right and left).

Step 5 - Re-check the gaps using the template and repeat steps 1 to 4 if required and complete with step 5



8. LEVEL THE FREEZER DOOR



A Locate the height adjuster cam in the freezer door. Slightly loosen the three door attachment screws on both sides using a 3/8" hex socket driver.

B Locate and loosen the cam screw using the T-27 screw driver.



A Lift the door on the side requiring adjustment, rotate the cam to required position



- 0 - Initial position
- 1 - Lift by 0.050" (0.127 cm)
- 1 - Lower by 0.050" (0.127 cm)
- 2 - Lower by 0.100" (0.254 cm)
- 3 - Lower by 0.150" (0.381 cm)

B After adjustment tighten the 3 attachment screws using to 65 in-lb (7.34 N-m).

9. REMOVE PACKAGING

Remove all tape, foam and protective packing from shelves and drawers.

Anti-Tip Floor Brackets Installation (Models CYE and DWE only)

WARNING Tip Over Hazard



Built-in style models (CYE, CWE) are top heavy, especially with any doors open. These models must be secured with the anti-tip floor bracket to prevent tipping forward, which could result in death or serious injury. Read and follow the entire installation instructions for installing the anti-tip floor bracket packed with your refrigerator.

NOTE: If you did not receive an anti-tip bracket with your purchase, visit us online at cafeappliances.com/parts to receive one at no cost. In Canada, cafe.appliances.ca/parts. For installation instructions of the bracket, visit: cafeappliances.com/literature. In Canada, cafe.appliances.ca/literature.

MATERIALS YOU MAY NEED (not included)



Lag Bolts
1/4" (6 mm) x 1-1/2" (38 mm)



Anchor Sleeves
1/2" (12 mm) OD

Drill Bit Appropriate for Anchors

For Anti-Tip Bracket Mounted on CONCRETE Floors Only

AT-1 MEASURE CABINET OPENING AVAILABLE VS. REFRIGERATOR WIDTH

Measure width of cabinet opening where refrigerator will be placed, W.

Be sure to account for any countertop overhang, baseboard thickness and any clearance desired. Width, W, should not be less than 36" (91.44 cm). The refrigerator will be placed approximately in the middle of this opening.



TOOLS YOU WILL NEED



AT-2 LOCATING THE ANTI-TIP FLOOR BRACKET

A Place the anti-tip floor bracket locator template (included inside the anti-tip kit) onto the floor up against the rear wall, within W, and in line with the desired location of the RH side of the refrigerator (see Figure 1).



B Place the anti-tip floor bracket onto the locator template with its RH floor holes lined up with the floor holes indicated on the template sheet, of the sheet or the RH side of the refrigerator.

C Hold down in position and use the anti-tip floor bracket as a template for marking the holes based upon your configuration and type of construction as shown in Step 3. Mark the hole locations with a pencil, nail or awl.

NOTE:

- It is **REQUIRED** to use at least 2 screws to mount the floor bracket (one on each side of the anti-tip floor bracket). Both must be into either the wall or the floor. Figure 2 indicates all the acceptable mounting configurations for screws. Identify the screw holes on the anti-tip floor bracket for your configuration.



AT-3 ANTI-TIP BRACKET INSTALLATION

A WOOD Wall and Floor Construction:

- Drill the appropriate number of 1/8" (3 mm) pilot holes in the center of each floor bracket hole being used (a nail or awl may be used if a drill is not available) AND remove the locator template from the floor. •
- Mount the anti-tip floor bracket by fastening the 2, or recommended 4, #10-16 hex-head screws tightly into place as illustrated in Figure 3.

Figure 3 – Attachment to Wall and Floor



B CONCRETE Wall and Floor Construction:

- Anchors required (not provided): 4 each 1/4" (6 mm) x 1-1/2" (38 mm) lag bolts 4 each 1/2" (12 mm) O.D sleeve anchors
- Drill the recommended size holes for the anchors into the concrete at the center of the holes marked in Step 2.
- Install the sleeve anchors into the drilled holes. Place the anti-tip floor bracket as indicated in Step 2. Remove the locator template from the floor.
- Install the lag bolts through the anti-tip floor bracket and tighten appropriately.

C WOOD Wall and TILE Floor Construction:

- For this special case, locate the 2 wall holes identified in Fig.2. Drill an angled 1/8" (3 mm) pilot hole (approx. as shown in Fig. 3) in the center of each hole.
- Mount the anti-tip floor bracket using the Minimum Acceptable Installation #1, as illustrated in Fig. 2.

AT-4 POSITIONING THE REFRIGERATOR TO ENGAGE THE ANTI-TIP FLOOR AND BASE BRACKETS

A Before pushing the refrigerator into the opening, plug the power cord into the receptacle and connect waterline (if equipped). Check for leaks.

B Locate the refrigerator's RH side and move back approximately in line with the RH side of the cabinet opening, W. This should position the anti-tip floor bracket to engage the anti-tip base bracket on the refrigerator.

C Gently roll the refrigerator back into the cabinet opening until it comes to a complete stop. Check to see if the refrigerator front lines up with the cabinet front face. If not, carefully rock the refrigerator forward and backward until engagement occurs and you notice that the refrigerator is fully pushed up against the rear wall.

D If Applicable: Adjust the rear (and front) wheel height settings to fully engage the rear anti-tip brackets, while also aligning the refrigerator front with the cabinet front face.

10. CONNECTING THE REFRIGERATOR TO THE HOUSE WATER LINE

A cold water supply is required for automatic ice maker operation. If there is not a cold water supply, you will need to provide one. See Installing the Water Line section.

NOTES:

- Before making the connection to the refrigerator, be sure the refrigerator power cord is not plugged into the wall outlet.
- If your refrigerator does not have a water filter, we recommend installing one if your water supply has sand or particles that could clog the screen of the refrigerator's water valve. Install it in the water line near the refrigerator. If using SmartConnect™ Refrigerator Tubing Kit, you will need an additional tube (WX08X10002) to connect the filter. Do not cut plastic tube to install filter.
- Before connecting the water line to the house, purge the house line for at least 2 minutes.

A If you are using copper tubing, place a compression nut and ferrule (sleeve) onto the end of the tubing coming from the house cold water supply.

If you are using the SmartConnect™ tubing, the nuts are already assembled to the tubing.

WARNING ELECTRIC SHOCK HAZARD

Attach tubing clamp using existing hole only. DO NOT drill into the refrigerator.

B If you are using copper tubing, insert the end of the tubing into the refrigerator connection, at the back of the refrigerator, as far as possible. While holding the tubing, tighten the fitting. If you are using SmartConnect™ tubing, insert the molded end of the tubing into the refrigerator connection, at the back of the refrigerator, and tighten the compression nut until it is hand tight. Then tighten one additional turn with a wrench. Over tightening may cause leaks.

C Fasten the tubing into the clamp provided to hold it in position. You may need to pry open the clamp

WARNING

Connect to potable water supply only. A cold water supply is required for automatic icemaker operation. The water pressure must be between 40 and 120 psi (275-827 kilopascals)





11. TURN ON THE WATER SUPPLY



Turn the water on at the shutoff valve (house water supply) and check for any leaks

12. PLUG IN THE REFRIGERATOR



See the grounding information attached to the power cord.

13. LEVEL THE REFRIGERATOR



The leveling legs have 2 purposes:

1. Leveling legs adjust so the refrigerator is firmly positioned on the floor and does not wobble.
2. Leveling legs serve as a stabilizing brake to hold the refrigerator securely in position during operation and cleaning. The leveling legs also prevent the refrigerator from tipping.

A Turn the leveling legs clockwise to raise the refrigerator, counterclockwise to lower it



NOTICE: To avoid possible property damage, the leveling legs must be firmly touching the floor

. LEVEL THE REFRIGERATOR DOORS

Remember a level refrigerator is necessary for getting the doors perfectly even. If you need help, review the previous section on leveling the refrigerator

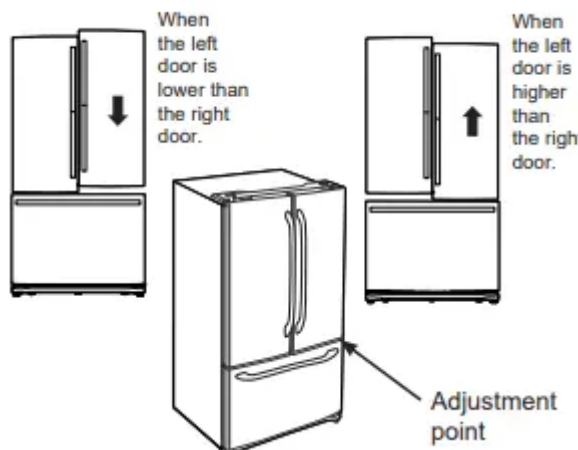

A If you open the freezer door, you can see the center hinge.

B Insert 1/4" Allen wrench into the shaft of the center hinge.

C Adjust the height by turning clockwise or counterclockwise. When you turn counterclockwise, the door will move up



Refrigerator Assembly Instructions, suggested assembly.

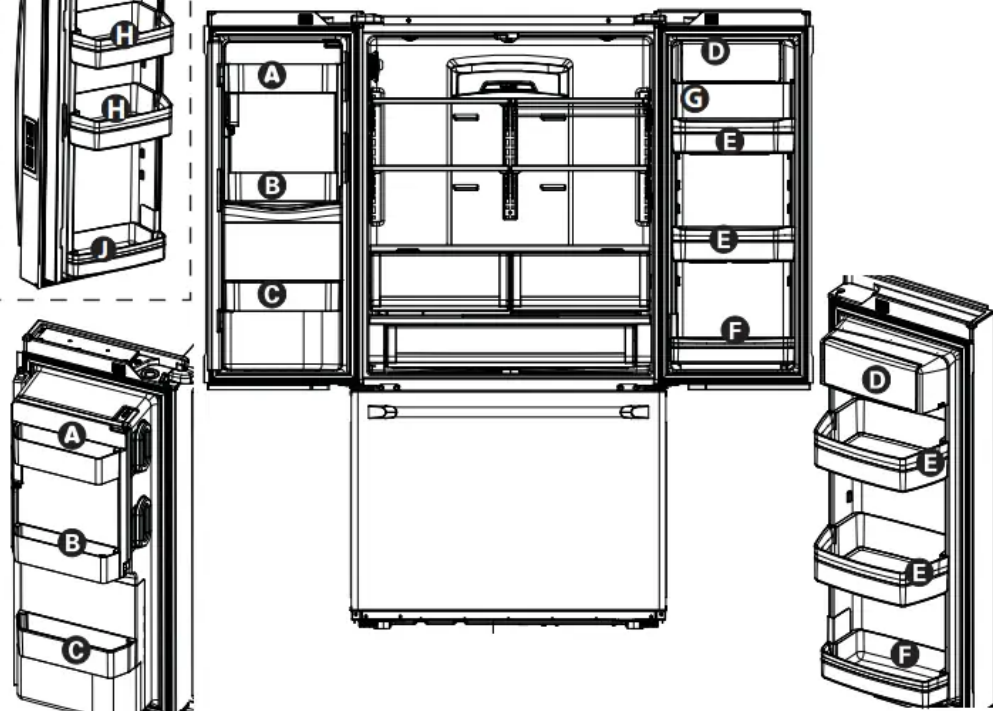

To place bins into doors:

- 1 Match your bin with the letter shown. Position the bin hooks over the bin locator and push forward until inserted fully.

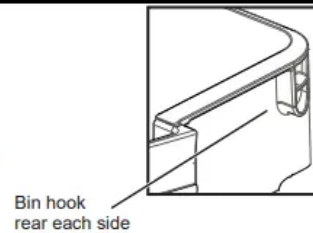

- 2 Push bin down until locked into position.

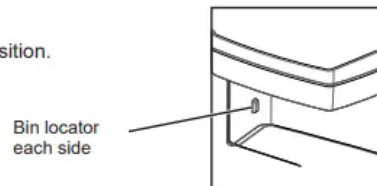

INSTALLING THE WATER LINE

BEFORE YOU BEGIN

Recommended copper water supply kits are WX8X2, WX8X3 or WX8X4, depending on the amount of tubing you need. Approved plastic water supply lines are SmartConnect™ Refrigerator Tubing (WX08X10006, WX08X10015 and WX08X10025).

When connecting your refrigerator to a Reverse Osmosis Water System, the only approved installation is with a RVKit. For other reverse osmosis water systems, follow the manufacturer's recommendations.

If the water supply to the refrigerator is from a Reverse Osmosis Water Filtration System (RO) AND the refrigerator also has a water filter, use the refrigerator's water filtration cartridge in conjunction with an RO water filter can result in hollow ice cubes. Some models do not come equipped with the filter bypass plug. To obtain a free bypass plug, visit cafeappliances.com/service. In Canada, visit cafeappliances.ca/service.

This water line installation is not warranted by the refrigerator or ice maker manufacturer. Follow these instructions carefully to minimize the risk of expensive water damage. Water hammer (water banging in the pipes) in house plumbing can cause damage to refrigerator parts and lead to water leakage or flooding. Call a qualified plumber to correct water hammer before installing the water supply line to the refrigerator. To prevent burns and product damage, do not hook up the water line to the hot water line.

For LCD Models: If the refrigerator is operated before the water connection is made to the ice maker, see ICE MAKER under "settings" menu of the LCD Operations section and follow the screen commands to turn the ice maker OFF. Do not install the ice maker tubing in areas where temperatures fall below freezing. When using any electrical device (such as a power drill) during installation, be sure the device is double insulated or grounded in a manner to prevent the hazard of electric shock, or is battery powered.

All installations must be in accordance with local plumbing code requirements.

WHAT YOU WILL NEED



- Copper or SmartConnect™ Refrigerator Tubing kit, 1/4" outer diameter to connect the refrigerator to the water supply. If using copper, be sure both ends of the tubing are cut square.

To determine how much tubing you need: measure the distance from the water valve on the back of the refrigerator to the water supply pipe. Be sure there is sufficient extra tubing to allow the

refrigerator to move out from the wall after installation. SmartConnect™ Refrigerator Tubing Kits are available in the following lengths:

8' (2.4 m) – WX08X10006

15' (4.6 m) – WX08X10015

25' (7.6 m) – WX08X10025

WARNING

Connect to potable water supply only. A cold water supply is required for automatic icemaker operation. The water pressure must be between 40 and 120 psi (275-827 kilopascals)

NOTE: The only GE Appliances, a Haier company, approved plastic tubing is that supplied in SmartConnect™ Refrigerator Tubing kits. Do not use any other plastic water supply line because the line is under pressure at all times. Certain types of plastic will crack or rupture with age and cause water damage to your home.

- A water supply kit (containing tubing, shutoff valve and fittings listed below) is available at extra cost from your dealer or from cafeappliances.com/parts. In Canada, visit cafeappliances.ca/parts.
- A cold water supply. The water pressure must be between 20 and 120 p.s.i. (1.4–8.1 bar).



- Power drill.
- 1/2" or adjustable wrench.
- Straight and Phillips blade screwdriver.



- Two 1/4" outer diameter compression nuts and 2 ferrules (sleeves)- to connect the copper tubing to the shutoff valve and the refrigerator water valve. OR
- If you are using a SmartConnect™ Refrigerator Tubing kit, the necessary fittings are preassembled to the tubing.



- If your existing copper water line has a flared fitting at the end, you will need an adapter (available at plumbing supply stores) to connect the water line to the refrigerator OR you

can cut off the flared fitting with a tube cutter and then use a compression fitting. Do not cut formed end from SmartConnect™ Refrigerator tubing.



- Shutoff valve to connect to the cold water line. The shutoff valve should have a water inlet with a minimum inside diameter of 5/32" at the point of connection to the COLD WATER LINE. Saddle-type shutoff valves are included in many water supply kits. Before purchasing, make sure a saddle-type valve complies with your local plumbing codes.

1. SHUT OFF THE MAIN WATER SUPPLY

Turn on the nearest faucet long enough to clear the line of water

2. CHOOSE THE VALVE LOCATION

Choose a location for the valve that is easily accessible. It is best to connect into the side of a vertical water pipe. When it is necessary to connect into a horizontal water pipe, make the connection to the top or side, rather than at the bottom, to avoid drawing off any sediment from the water pipe



3. DRILL THE HOLE FOR THE VALVE

Drill a 1/4" hole in the water pipe (even if using a self-piercing valve), using a sharp bit. Remove any burrs resulting from drilling the hole in the pipe.

Take care not to allow water to drain into the drill.

Failure to drill a 1/4" hole may result in reduced ice production or smaller cubes.



4. FASTEN THE SHUTOFF VALVE

Fasten the shutoff valve to the cold water pipe with the pipe clamp.



NOTE: Commonwealth of Massachusetts Plumbing Codes 248CMR shall be adhered to. Saddle valves are illegal and use is not permitted in Massachusetts. Consult with your licensed plumber.

5 TIGHTEN THE PIPE CLAMP

Tighten the clamp screws until the sealing washer begins to swell.

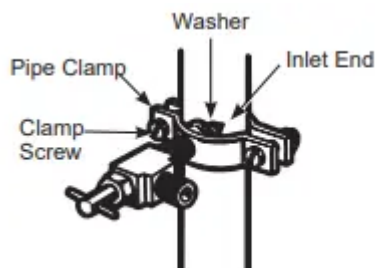

NOTE: Do not over tighten or you may crush the tubing.

6 ROUTE THE TUBING

Route the tubing between the cold water line and the refrigerator. Route the tubing through a hole drilled in the wall or floor (behind the refrigerator or adjacent base cabinet) as close to the wall as possible.

7 CONNECT THE TUBING TO THE VALVE

Place the compression nut and ferrule (sleeve) for copper tubing onto the end of the tubing and connect it to the shutoff valve. Make sure the tubing is fully inserted into the valve. Tighten the compression nut securely. For plastic tubing from a SmartConnect™ Refrigerator Tubing kit, insert the molded end of the tubing into the shutoff valve and tighten compression nut until it is hand tight, then tighten one additional turn with a wrench. Over tightening may cause leaks.



NOTE: Commonwealth of Massachusetts Plumbing Codes 248CMR shall be adhered to. Saddle valves are illegal and use is not permitted in Massachusetts. Consult with your licensed plumber

8 FLUSH OUT THE TUBING

Turn the main water supply on and flush out the tubing until the water is clear. Shut the water off at the water valve after about one quart (1 liter), or 2 minutes, of water has been flushed through the tubing.



To complete the installation of the refrigerator, go back to Step 11 in Installing the Refrigerator.

Troubleshooting Tips

Water filter indicated as installed incorrectly or a leak is present message on LCD screen.

- Water filter installed backward or is leaking.
 - Check for leak. If no leak is present, remove filter/bypass plug, rotate 180° and reinstall.

Water filter indicator light remains lit after replacing filter.

- Filter timer has not been reset or filter is installed backward.
 - **Internal Dispense models:** Press and hold reset button for 3 seconds
 - **External Dispense models:** Remove filter and rotate 180° and reinstall.

Handle is loose/handle has a gap.

- Handle needs adjusting
 - See Attach Fresh Food Handle and Attach the Freezer Handle sections for detailed instructions.

Refrigerator beeping

- This is door alarm
 - Turn off or disable with door closed. If door open and alarm is sounding, you can only snooze the alarm.

Not cooling

- The cooling system is off
 - See About Controls.

Water has poor taste/odor

- Water dispenser has not been used for a long time
 - Dispense water, until all water in system is replenished.

Water in glass is warm

- Normal when refrigerator is first installed
 - Wait 24 hours for the refrigerator to completely cool down.
- Water dispenser has not been used for a long time
 - Dispense water, until all water in system is replenished.
- Water system has drained
 - Allow several hours for replenished supply to chill.

Water dispenser does not work

- Water supply line turned off or not connected
 - See Installing the Water Line.
- Water filter clogged or filter/bypass plug not installed
 - Replace filter cartridge or remove filter and install bypass plug.*
- Air may be trapped in the water system
 - Press the dispenser arm for at least 5 minutes.
- Water in reservoir is frozen because the controls are set too cold
 - Set the refrigerator control to a warmer setting and wait 24 hours. If the water does not dispense after 24 hours, schedule service on-line at cafeappliances.com/service

Water spurting from dispenser

- Newly installed filter cartridge
 - Run cold water from the dispenser for 5 minutes (about 2 gallons)..

Water is leaking from dispenser

- Air may be present in the water line system, causing water to drip after being dispensed
 - Dispense water for at least 5 minutes to remove air from system

No water or ice cube production

- Supply line or shutoff valve is clogged
 - Call a plumber
- Water filter is clogged
 - Replace filter cartridge or remove filter and install bypass plug*
- Filter cartridge not properly installed
 - Remove and reinstall filter cartridge, being certain that it locks in place
- Ice maker is turned off
 - Check that the ice maker is turned on. See About the Automatic Ice Maker.

*Some models do not come equipped with the filter bypass plug. To obtain a free bypass plug, visit us on-line at cafeappliances.com/service. In Canada, visit cafeappliances.ca/service

PRECISE FILL will not fill container

- Normal, **PRECISE FILL** requires use of dispenser paddle
 - For a specific amount of water, select PRECISE FILL to dispense water

Photos not found

- Photos not in root directory of USB
 - Make sure the photos are in the root directory in your USB
- Photos not in JPEG format
 - Photos must be in JPEG format
- Camera/ PC used with USB cord
 - Must use a USB drive

Freezer cooling, fresh food not cooling

- Normal, when refrigerator first plugged in or after extended power outage
 - Wait 24 hours for temperature in both compartments to reach selected temperatures.

Ice dispenser opens after closing freezer drawer

- Normal
 - The ice dispenser door may open after closing freezer door to allow access

Hot water does not work

- Operation disabled
 - Make sure "Hot Water Disabled" is not selected



- Low water pressure
 - Make sure water line is not kinked
- Water supply line turned off or not connected
 - See Installing the Water Line
- Water filter clogged or filter/bypass plug not installed
 - Replace filter cartridge or remove filter and install bypass plug*

Hot water continues to dispense for a short time after releasing the knob

- Water filter is partially clogged or low water pressure (<40 psi)
 - Replace filter cartridge or remove filter and install bypass plug* or increase water pressure

Difficult to open the Icebox door

- Icebox door gasket might stick to main door if it remains closed for a long duration
 - Disengage the door latch, wait for 3 minutes then open the Icebox door

Fresh food door not closing fully

- Fresh food door gasket may have unseated and interfering with articulating mullion operation
 - Reseat the gasket all the way in the groove

Low brewing flow rate

- There may have been a dent at the bottom of K-Cup causing the pin to pierce the filter allowing coffee grounds clogging the bottom pin
 - Avoid using damaged/dented K-cups, and clean the lower needle before next brew

Low brewing flow rate / water drips from inner door

- Top needle of the brewer clogged
 - Unclog the top needle holes using a paper clip and rinse brewer. Rinse brewer after every use.

Brewer stuck in the door bracket

- Dispenser is in hot water dispense mode instead of brew mode while the brew module is installed
 - Cancel hot water dispense mode so hot water tube will retract from the brew module

Brewer is not detected by the screen menu or hot water leaking from top of the brewer

- Incorrect assembly of brewer in the bracket
 - Make sure the Keurig Logo is in the front. Push brewer all the way in the brackets

Coffee dispensed with splash or bubble bursting

- Blocked vent hole in the brewer
 - Make sure the vent hole at the bottom of the brewer is clear from food or any other contamination

Beverage quality not as expected

- You may be using non-standard or out dated K-Cups
 - Recommend using official Keurig K-cups that are not past expiration and have not been damaged

Liquid drips from the brewer after brewer cycle is completed and the brewer is removed from the bracket

- It is possible for liquids to be retained by the brewer and drip when it is removed
 - Use a cloth or container to capture the drips when brewer is removed

*Some models do not come equipped with the filter bypass plug. To obtain a free bypass plug, visit us on-line at cafeappliances.com/service. In Canada, visit cafeappliances.ca/service

Delay when using Keurig K-cup Pod dispenser

- To ensure a quality beverage is delivered, a short delay is required to ensure the refrigerator is operating correctly
 - Ensuring consistent, quality operation requires the refrigerator to delay dispense for a short period of time

After brewing, my powdered beverage is not fully cleared from the used pod

- Depending on size selected, the powder may not dissolve fully. Some powdered beverages develop into 'clumps' when left sitting for some time
 - Shake the powdered pods before brewing to break up these clumps and allow better clearing. For powdered beverage with no filter, use the Cocoa cycle selection

Brewer lid is difficult to close

- K-cup is not fully seated
 - Press K-cup all the way down into the brewer prior to closing the lid. Lower needle must puncture K-cup before closing the brewer lid

Brewer leaks during the brew cycle

- Trouble in closing brewer lid or damaged K-cup
 - Press K-cup all the way down into the brewer prior to closing the lid. Lower needle must puncture K-cup before closing the brewer lid. Recommend using official Keurig K-cups that have not been damaged and have a good seal between the top cover and plastic bottom

Truth or Myth

The refrigerator water filter may require replacement prior to six months of use

- TRUE
 - The water filter indicator will indicate the need to replace the water filter every six months or 170 gallons (643.52 liters) of water dispensed (select models only). Water quality varies from city to city. If water flow from the dispenser slows, or ice production decreases, the water filter should be replaced, even though the filter indicator may not indicate the need for replacement.

The automatic ice maker in my refrigerator will produce ice when the refrigerator is plugged in to a power receptacle.

- MYTH
 - The refrigerator must be connected to water, and the ice maker must be turned on. Make sure the ice maker is turned on, only after the water line is connected and water is turned on. The ice maker can be turned on/off from the controls and ensure the ice maker is on, as indicated on the refrigerator control panel. See Automatic Ice Maker section.

After the refrigerator has been plugged in and connected to water, I will immediately have unlimited chilled water available from the water dispenser.

- MYTH
 - The water dispenser tank located inside the refrigerator stores water for dispensing. The water in this tank requires 24 hours to chill after installation. High usage conditions will not allow time for the water to chill.

After water dispenses, a few drops of water are normal.

- TRUE
 - A few drops of water may fall from the dispenser, after the dispenser paddle has been released. To minimize the drops, remove the glass slowly from the dispenser.

I will never see frost inside the freezer compartment.

- MYTH

- Frost inside the freezer typically indicates that the door is not properly sealed, or has been left open. If frost is found, clear the frost using a plastic spatula and towel, then check to ensure that no food packages or containers are preventing the freezer door from closing. Check the refrigerator control panel to ensure the door alarm is on.

When the refrigerator is installed, or after replacing the water filter, I must dispense water for five minutes.

- TRUE

- A newly installed refrigerator or water filter contains air in the water lines. Press the dispenser paddle and dispense cold water for at least 5 minutes to remove air from the water line, and flush the filter.

To fill the ice bucket to the maximum capacity, I should dispense 12 and 18 hours after installation.

- TRUE

- Dispensing 3-4 cubes 12 hours and 18 hours after installation, allows ice to disperse within the ice bucket, which in turns calls on the ice maker to produce additional ice. Normal ice production = 100 cubes in 24 hours.

I can use the water filter bypass plug to determine if the filter requires replacement.

- TRUE

- Decrease in flow from the water dispenser, or decreased ice production, may indicate the need to replace the water filter. Install the water filter bypass plug (provided with the refrigerator on some models*), and check flow from the dispenser. If water flow returns to normal with the bypass plug in place, replace the water filter.

The top of the refrigerator doors will always be aligned.

- MYTH

- Several things can affect the fresh food door alignment, including the floor the refrigerator is installed on and loading of doors. If the top of the fresh food doors are not aligned, use 1/4" allen wrench to adjust the right/left hand door. The adjustment screw is located on the bottom right or left hand side of the door; open the freezer door to access the screw.

Refrigerator door handles can be easily tightened.

- TRUE
 - If door handles are loose or have a gap, the handle can be adjusted using a 1/8" allen wrench, on set screws located on the ends of the handles.

There may be odor and taste problems with your ice.

- TRUE
 - After starting the ice maker throw away 24 hours of ice production to avoid odor and taste problems.

I can make fine adjustments to the fresh food doors to align them.

- TRUE
 - If the fresh food doors are not aligned, use a 1/4" Allen wrench to adjust the right hand door. The adjustment screw is located on the bottom of the right/left door. Open the freezer door to access.

Door handles should always be removed for installation.

- MYTH
 - Check chart on reverse side of this instruction. If the doors must be removed do not remove the handles, or if the refrigerator will fit easily through the passage way opening. Adjust handles that are loose or have a gap, by adjusting 1/8" set screws on either end of handles.

Door removal is always required for installation.

- MYTH
 - Check chart on reverse side of this instruction. Doors should only be removed when necessary to prevent damage from passage way or access to final location.

Refrigerator doors that won't close after installation, can be adjusted to close properly.

- TRUE
 - Door mechanism works best if installed at 90°+. If installed at 180°, remove the door from the mid hinge, and swing the door 180° before reinstalling. See Reinstalling the Refrigerator Doors.

There is an adjustment to rear wheels.

- MYTH
 - Front leveling legs are adjustable and should be used to balance the refrigerator. Leveling legs are used to make initial fresh food door adjustment.

Check for leaks after all water connections are made.

- TRUE
 - While purging the air from the water system, check all water line connections for leaks. Check the connection to the household water supply at back of refrigerator, and door water line connect.

My LCD display will always be on when I plug the power cord in at installation.

- MYTH
 - If the refrigerator has been stored in a cold environment, the LCD may be slow to give a proper display. Give the refrigerator enough time to warm up, and the display should be okay.

Any packaging residue can be cleaned off the refrigerator using any cleaner.

- MYTH
 - Do not use wax, polish, bleach, or other products containing chlorine on Stainless Steel panels, door handles and trim. Check this instruction under "Cleaning the Outside" for full details.

Warning

This content is compiled from multiple sources and is provided for reference purposes only. It may not be complete or fully applicable to all situations. If you are unable to resolve your issue, please contact the product manufacturer or an authorized service provider for official support.