

OPERATING YOUR DISHWASHER

Prepare and load the dishwasher

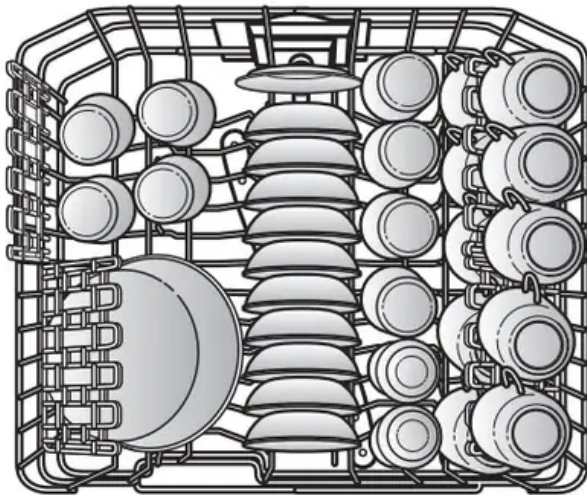

10-place load – upper rack

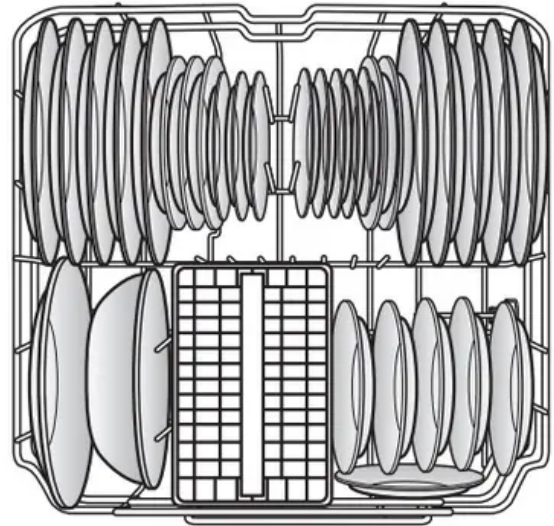

10-place load – lower rack

IMPORTANT: Remove leftover food, bones, toothpicks, and other hard items from dishes. Remove labels from containers before washing.

- Make sure when dishwasher door is closed, no items are blocking detergent dispenser.
- Items should be loaded with soiled surfaces facing down and inward to the spray as shown in the graphics above. This will improve cleaning and drying results. Angle dirtiest dish surface downward, allowing space for water to flow up through rack and between dishes.
- Avoid overlapping items, like bowls or plates, that may trap food.
- Place plastics, small plates, and glasses in upper rack.
- Wash only items marked “dishwasher safe.”
- To avoid thumping/clattering noises during operation, load dishes so they do not touch one another. Make sure lightweight load items are secured in racks.
- Use slots in the covers and suggested loading patterns to keep your silverware separated for optimum wash.

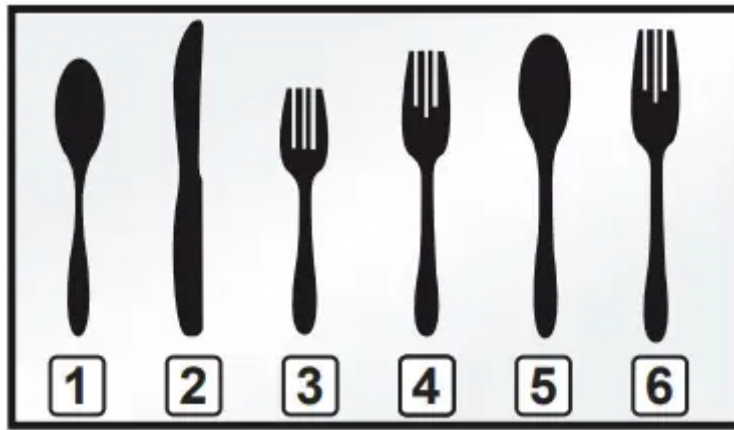

1. Spoons
2. Knives
3. Salad forks
4. Forks
5. Large spoons
6. Large forks

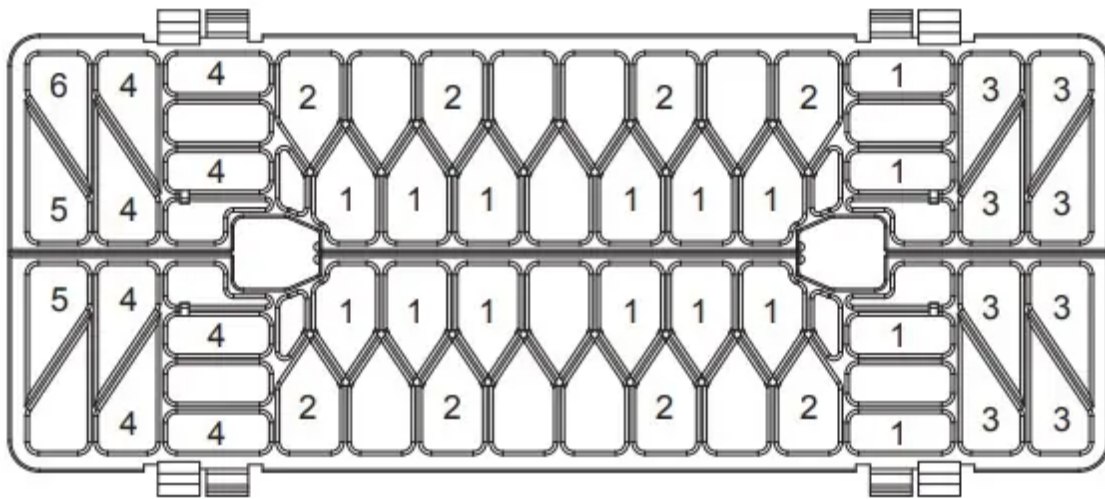

- If your silverware does not fit into the designated slots, lift and slide covers off to remove them and mix silverware types to keep them separated.

- When loading silverware, always place sharp items pointing down and avoid “nesting” as shown.



Check that all arms spin freely

Items in the rack can block the spray arms

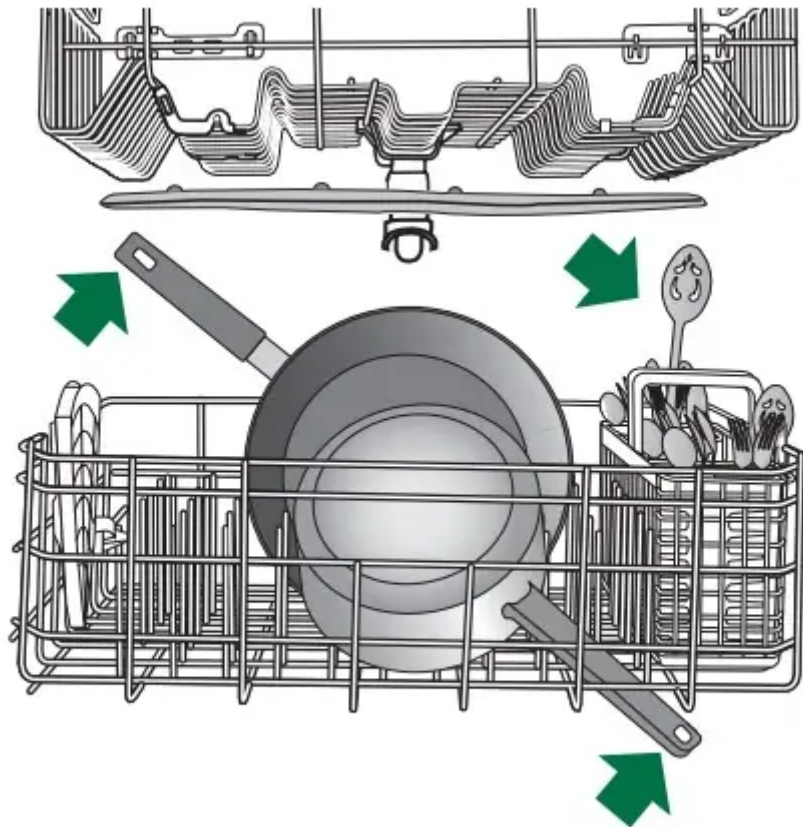

Add detergent

Premeasured Detergents

High-quality premeasured tablets and packs are recommended for improved performance. Quality tablets and packs have been proven better than powder, liquid, or gel detergents at reducing filming on dishes. Using tablets and packs over time will start to reduce or eliminate white film. They are suitable for all water hardness and soil levels. Also, by using a rinse aid, you can minimize repeat buildup of white film (not all packs and tablets contain rinse aid). Always place premeasured detergents in main compartment and close lid.

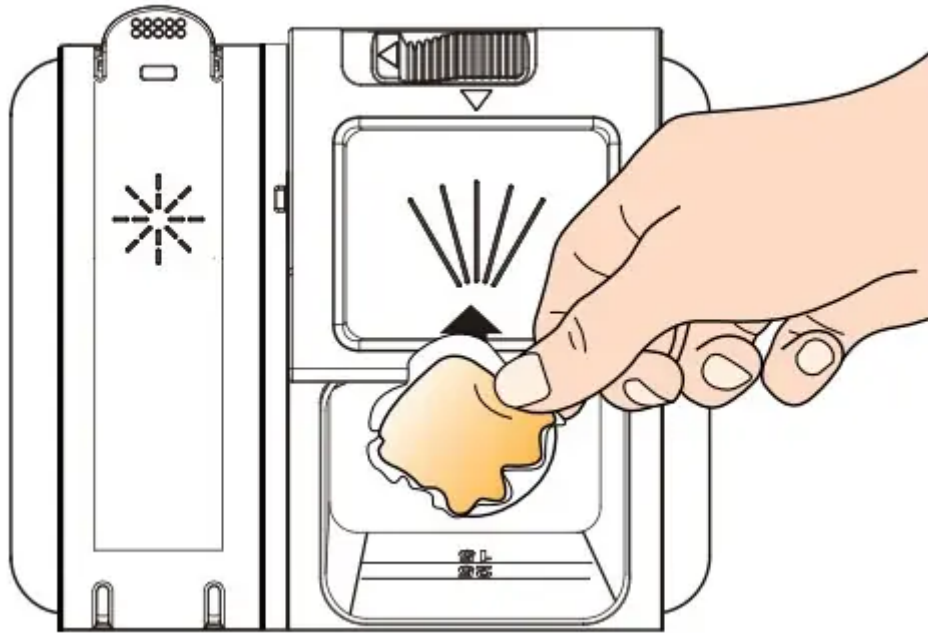

NOTE: Follow instructions on the package when using other dishwasher detergent types. See the complete User Instructions for more details about powders, liquids, and gels.

- Use automatic dishwasher detergent only. Add detergent just before starting a cycle.
- Fresh automatic dishwasher detergent results in better cleaning. Store tightly closed detergent container in a cool, dry place.

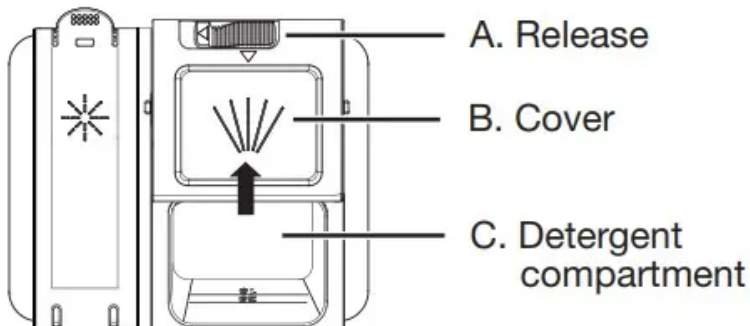

Close the detergent dispenser by sliding cover (B) over detergent compartment (C).

Open the detergent dispenser by sliding release (A) to the left and the cover (B) will automatically slide open.

Add rinse aid

- Your dishwasher is designed to use rinse aid for good drying performance. Without rinse aid, your dishes and dishwasher interior will have excessive moisture. The heating and drying options will not perform as well without rinse aid.

- Rinse aid keeps water from forming droplets that can dry as spots or streaks. It also improves drying by allowing water to drain off of dishes after final rinse. Rinse aid does not adhere to dishware, and when used, it is dispensed during each cycle.
- To add rinse aid, open the dispenser lid by gently pushing in the center of the lid with your thumb while lifting up on the edge.

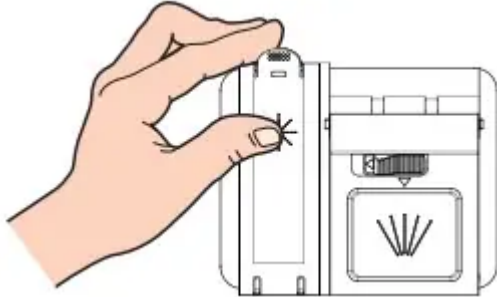

- Pour rinse aid into the opening until the indicator level shows that it is full. Do not fill the reservoir above the full level indicator. Excess rinse aid can cause suds and water to overflow during the wash cycle.
- Close dispenser by pushing down gently on the lid until it clicks into place.



Select a cycle

NOTE: Heavier cycles and options lengthen cycle times. Choose a cycle appropriate for the food soils and dishes that you load. See the cycle descriptions in the Cycle Guide section.

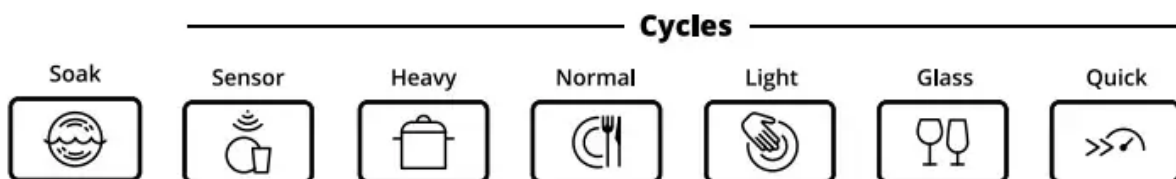

Select options

You can customize your cycles by selecting the options desired (see the Cycle Guide). If you change your mind, touch the option again to turn off the option. If an invalid option is selected for a given cycle, the lights will flash. Adding options may increase the cycle time.

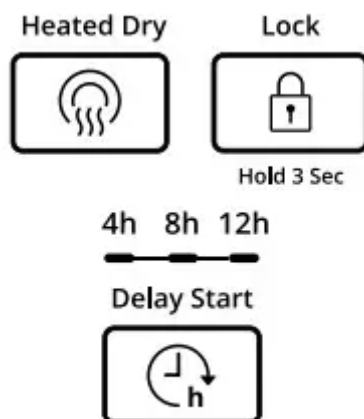

Start or resume a cycle

NOTE: If needed, run hot water at the sink nearest your dishwasher until the water is hot. Turn off water. With door firmly closed touch the START/Pause button.

Start / Pause



IMPORTANT: If the door is opened for any reason after the cycle is started (even during the delay time), the Start/Pause button must be touched again after the door is closed. If Start/Pause button is not touched, the cycle will not resume.

Follow the progress of your dishwasher

When the cycle is complete, the Complete light will remain on until the door is opened and closed or the Start/Pause button is touched.

Washing > Rinsing > Complete







Add Rinse
Aid

CYCLE GUIDE

IMPORTANT: The sensor in your dishwasher monitors the soil level. Cycle time and/or water usage can vary as the sensor adjusts the cycle for the best wash performance. If the incoming



water is less than the recommended temperature or food soils are heavy, the cycle will automatically compensate by adding time, heat, and water as needed.



The dishwasher remembers the cycle and options selections from the most recently completed cycle. To run the same cycle and options as the last time, touch the START/Pause button twice—once to wake up the controls, and again to start the dishwasher.

CYCLES		ESTIMATED WASH TIME W/O OPTIONS HH:MM	WATER USAGE GALLONS (LITERS)
 Soak	Use for rinsing dishes, glasses, and silverware that will not be washed right away. Do not use detergent.	0:10	2.1 G (8.0 L)
 Sensor	This cycle senses the soil amount, to adjust amount of water and time needed.	1:45 - 3:18	2.9 - 5.8 G (11.1 - 21.8 L)
 Heavy	Use for hard-to-clean, heavily soiled pots, pans, casseroles, and regular tableware. Includes Heated Dry option.	2:30 - 2:50	5.8 G (22.1 L)
 Normal	This cycle is recommended for daily, regular, or typical use to completely wash and dry a full load of normally soiled dishes. This dishwasher's government energy certifications were based on the Normal cycle with only the Heated Dry option selected.*	1:30 - 2:10	2.9 - 5.6 G (11.1 - 21.2 L)
 Light	For lightly soiled loads. Includes Heated Dry option.	1:45	5.0 G (19.0 L)
 Glass	For lightly soiled glassware. Includes Heated Dry option.	1:45	4.9 G (18.4 L)
 Quick	For fast results, the Quick cycle will clean lightly soiled loads that do not need drying. Includes Heated Dry option. NOTE: Some detergents are not recommended for short wash cycles; please refer to your detergent packaging for more information.	0:55	4.0 G (15.0 L)

*No other washing and drying temperature options were selected, and the dishwasher was not subjected to truncated testing. Rinse aid was not used, and there was no detergent used in the prewash.



OPTIONS	CAN BE SELECTED WITH	WHAT IT DOES	ADDED TIME TO CYCLE	ADDED WATER GALLONS (LITERS)
 <p>Heated Dry</p> <p>Dries dishes with heat. This option, with the use of rinse aid, will provide the best drying results. Plastic items are less likely to deform when loaded in the upper rack. Use Heated Dry for optimum drying performance. For air dry, turn off Heated Dry.</p>	Available with any cycle	Uses a heating element to speed drying times. Heated Dry option defaults to On when any cycle is selected, except for Rinse.	0 - 0:05	NA
 <p>Lock</p> <p>Hold 3 Sec</p> <p>To lock the controls, touch and hold Lock for 3 seconds. The Lock light will turn on indicating that it is activated. When the Lock indicator is lit, all buttons are disabled. If you touch any button while your dishwasher is locked, the light flashes once. The dishwasher door can still be opened and closed while the controls are locked. To turn off Lock, touch and hold the Lock button for 3 seconds. The Lock indicator light will turn off.</p>	Available with any cycle	When the Lock indicator is lit, all buttons are disabled. Eliminates unintended use of dishwasher between cycles, or cycle and option changes during a cycle.	NA	NA
 <p>4h 8h 12h</p> <p>Delay Start</p> <p>To delay the start:</p> <ol style="list-style-type: none"> 1. Select a wash cycle and options. 2. Touch DELAY START for each hour of delay time. 3. Touch START/Pause to begin the delay countdown. <p>NOTE: If the door is opened, such as to add a dish, the Start/Pause button must be touched to resume the delay countdown.</p>	Available with any cycle	Delays start of a cycle up to 24 hours.	4:00 - 12:00	NA

Control	Purpose	Comments
 <p>On/Off</p>	Touch to turn the dishwasher on or off.	Touch and hold for 1 second to turn the dishwasher on before making any selections. To turn the dishwasher off, touch and hold for 2 seconds. This will stop the operation of the dishwasher and deactivate any cycles and options selected. The dishwasher will start a 60-second drain. Let dishwasher drain completely.
 <p>Cancel</p>	Touch to cancel wash cycle.	With the door closed and the cycle or delay running, touch the Cancel button. The dishwasher starts a 60-second drain. Let dishwasher drain completely.
 <p>Start / Pause</p>	<p>Touch to start or resume a wash cycle.</p> <p>Touch once to temporarily interrupt the cycle without canceling.</p>	<p>If the door is opened during a cycle or the power is interrupted, the cycle will not resume until the Start/Pause button is touched again.</p> <p>With a cycle running, touch START/Pause button once. This will interrupt the cycle without canceling. Opening the door will also interrupt the cycle in the same way. Close the door and touch START/Pause again to resume the cycle.</p>

DISHWASHER CARE

Cleaning the Exterior

Clean the exterior of the dishwasher with only a soft, damp cloth and mild detergent. Avoid using abrasive cleaning products on the exterior of the dishwasher.

Cleaning and Maintaining the Interior

Many detergents may leave white spots or a white residue on dishware and on the interior of the dishwasher. Over time this residue can become unsightly and could affect dishwasher performance. Use of a dishwasher cleaning product such as affresh® Dishwasher Cleaner can help to remove the residue. Monthly use of affresh® Dishwasher Cleaner is recommended to help maintain the dishwasher. Follow package directions.

NOTE: Whirlpool recommends the use of high-quality premeasured detergent tablets or packs and the use of rinse aid for dishwasher cleaning and daily care. If you have a drain air gap, check and clean it if the dishwasher isn't draining well.



To Reduce Risk of Property Damage During Vacation or Extended Time Without Use:

- When you will not be using the dishwasher during the summer months, turn off the water and power supply to the dishwasher.
- Make sure the water supply lines are protected against freezing conditions. Ice formations in the supply lines can increase water pressure and cause damage to your dishwasher or home. Damage from freezing is not covered by the warranty.
- When storing your dishwasher in the winter, avoid water damage by having your dishwasher winterized by authorized service personnel.

TROUBLESHOOTING



If you experience	Recommended solutions
<p>Dishwasher does not run or stops during a cycle</p>	<p>It is normal for certain cycles to repeatedly pause for several seconds during the main wash. Is the door closed tightly and latched?</p> <p>Is the right cycle selected?</p> <p>Is there power to the dishwasher? Has a household fuse blown or has a circuit breaker tripped? Replace the fuse or reset the circuit breaker. If the problem continues, call an electrician.</p> <p>Is the water shut-off valve (if installed) turned on?</p>
<p>Dishes do not dry completely</p>	<p>NOTE: Plastic and items with nonstick surfaces are difficult to dry because they have a porous surface which tends to collect water droplets. Towel drying may be necessary. Use of rinse aid along with the Heated Dry option is needed for proper drying. Proper loading of items can affect drying. Glasses and cups with concave bottoms hold water. This water may spill onto other items when you are unloading the dishwasher. For improved results, place these items on the more slanted side of the rack.</p> <ul style="list-style-type: none"> • Unload the lower rack first.
<p>Noise</p>	<p>NOTE: Common noises:</p> <ul style="list-style-type: none"> • Surging sounds can occur periodically throughout the cycle while the dishwasher is draining. • Normal water valve hissing may be heard periodically. • A normal snap sound may be heard when the detergent dispenser opens during the cycle or when the door is opened at the end of the cycle. • Improper installation will affect noise levels. <p>Be sure the filters are properly installed. A thumping sound may be heard if items interfere with the wash arms. Readjust the dishware and resume the cycle.</p>
<p>Spotting/ Filming</p>	<p>Liquid rinse aid is necessary for drying and to reduce spotting. Use the correct amount of detergent. Confirm that the cloudiness is removable by soaking the item in white vinegar for 5 minutes and dry the item. If the cloudiness disappears, it is due to hard water.</p>



	<p>Adjust the amount of detergent and rinse aid. See the “Dishwasher Care” section. If cloudiness on glass does not come clear, it is due to etching. Be sure the incoming water temperature is set at 120°F (49°C).</p> <p>To remove spotting, run a vinegar rinse through the dishwasher.</p> <ul style="list-style-type: none"> • Wash and rinse the affected dishware and load into dishwasher. Remove all silverware and metal items. Put 2 cups (500 mL) of white vinegar in a 2-cup capacity measuring cup and place upright in the lower rack. Run a Normal cycle with the Heated Dry option turned off and no detergent. See the “Dishwasher Care” section in full User Instructions.
<p>Dishwasher does not clean completely</p>	<p>Be sure the dishwasher is loaded correctly. Improper loading can greatly decrease the washing performance. See the “Operating Your Dishwasher” section.</p> <p>Check filter to ensure it is properly installed. Clean it if needed. See the “Filtration System” section in the full User Instructions for details. Select the proper cycle for the type of soils. The Heavy wash cycle can be used for tougher loads.</p> <p>Be sure the incoming water temperature is 120°F (49°C). Use the proper amount of fresh detergent. More detergent is needed for heavier-soiled loads and hard water conditions.</p> <p>Scrape food from dishes prior to loading (do not prerinse). Suds can come from:</p> <ul style="list-style-type: none"> • Using the incorrect type of detergent, such laundry detergent, hand soap, or dish detergent for hand-washing dishes. • Not replacing the rinse aid dispenser cap after filling (or refilling) the rinse aid dispenser. • Using an excessive amount of dishwasher detergent.
<p>Dishwasher does not drain</p>	<p>Be sure the cycle has been completed (the Complete light is on). If it has not, you will need to resume the cycle by closing the door and touching Start/Pause.</p> <p>If dishwasher is connected to a food waste disposer, be sure the knockout plug has been removed from the disposer inlet.</p> <p>Check for kinks in the drain hose.</p>



Check for food obstructions in the drain or disposer.

Check your house fuse or circuit breaker.

Warning

This content is compiled from multiple sources and is provided for reference purposes only. It may not be complete or fully applicable to all situations. If you are unable to resolve your issue, please contact the product manufacturer or an authorized service provider for official support.