

Getting Started

1. Connect to your TV.

Follow the steps **1** to **4** below to connect your PlayStation4 system to your TV.

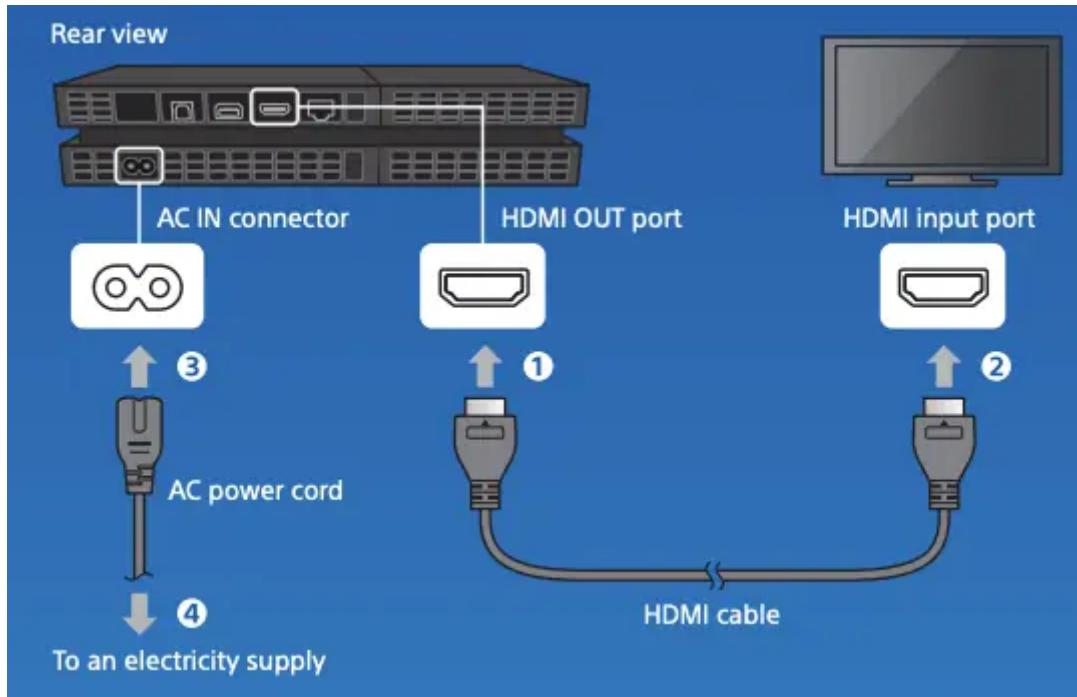

2. Connect to a LAN cable (sold separately).

No Wi-Fi connection? You can use a LAN cable to connect your PS4 system to the Internet instead.

To connect your PS4 system to the Internet via Wi-Fi, do not connect a LAN cable.

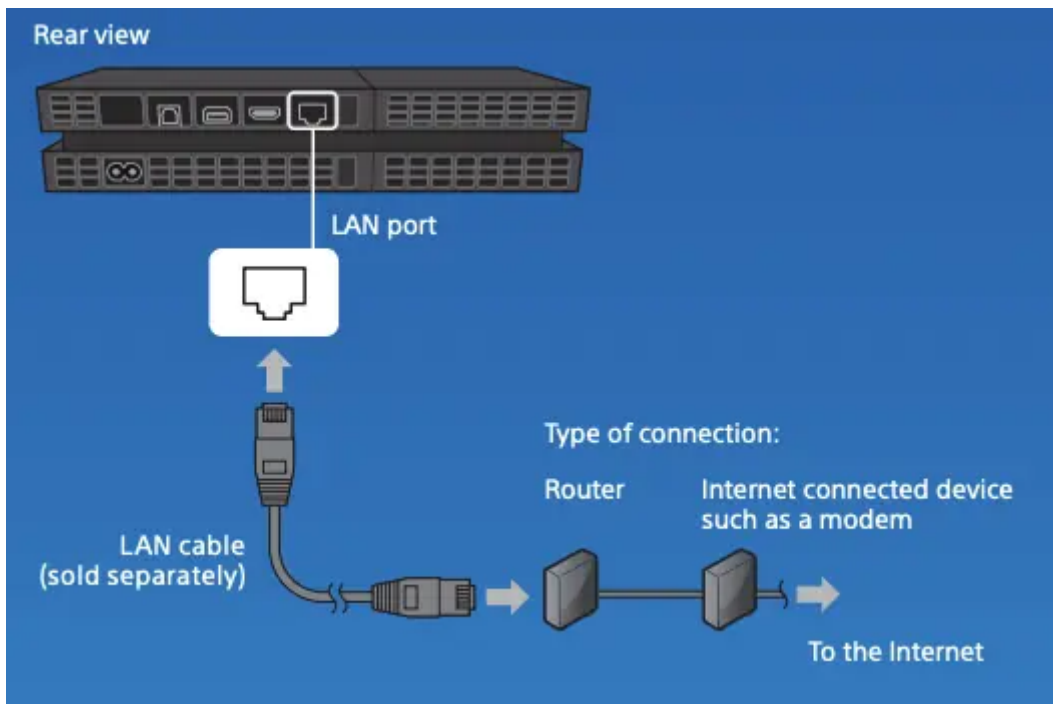



We recommend connecting your PS4 system to the Internet to get the most out of it.

3. Turn on your TV. and then change the TV channel to HDMI.

4. Turn on your PS4 system by pressing the  (power) button.

The power indicator will blink  blue. before turning  white.



If you can't get a picture when the PS4 system is turned on (the power indicator will turn  white). simply press the  (power) button for at least 7 seconds (until the system beeps twice) to turn off the power. and then turn on the power again.

5. Connect your DUALSHOCK4 wireless controller to your PS4 system using the USB cable. and then press the  (PS) button.

The controller will be registered (paired). and turn on.

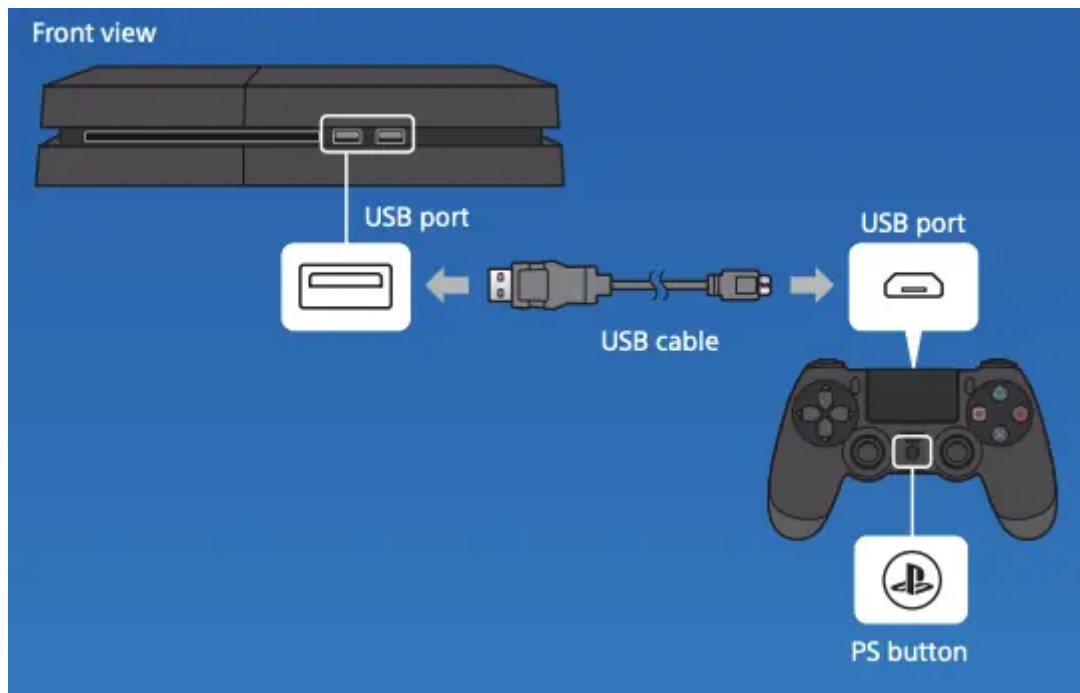

- You'll need to register the controller in some situations, such as when you use the controller for the first time, or when you use the controller on another PS4.
- Once you've registered the controller, you can disconnect the USB cable and use the controller wirelessly.

6. Select your settings.

Set up an Internet connection, set the date and time, and adjust other settings. Follow the on-screen instructions to adjust various settings, and then select [Start Now] from the set-up completion screen.

Once you have set up an Internet connection, a system software update will be downloaded automatically - as will future system software updates.

Will a child be using your PS4 system? If so, be sure to read "Setting the parental control" section.

You can change any settings that you previously skipped via  (Settings) in the function screen.

Setting the parental control

Some PS4 content may not be suitable for your child. Most PS4 content is rated by an independent ratings body.

To ensure your child only has access to suitably rated content, just set the correct parental control before you first let your child play.





You can set the parental controls in  (Settings) in the function screen > [Parental Controls] > [Restrict Use of PS4 Features] > [Application]. Use the tables below for guidance on how the Parental Control Setting relates to different age groups.

You can restrict access to Blu-ray Disc and DVD video content, and to the Internet Browser, from # (Settings) in the function screen > [Parental Controls] > [Restrict Use of PS4 Features].

Restricting access to the Internet Browser will not prevent launch of some applications that use the Internet.

Regardless of the Parental Control Settings, you should monitor your child's activity on the PS4 system. You can override the Parental Control Settings at any time to allow an older child or adult to play.

Europe, Africa and India

Player's Age	Under 3	3-6	7-11	12-15	16-17	18 and over
PS4™ Parental Control Setting	1	2	3	5	7	9
Highest game age rating						

Germany

Player's Age	Under 6	6-11	12-15	16-17	18 and over
PS4™ Parental Control Setting	1	3	5	7	9
Highest game age rating					

Portugal

Player's Age	Under 4	4-5	6-11	12-15	16-17	18 and over
PS4™ Parental Control Setting	1	2	3	5	7	9
Highest game age rating						

For more information on parental controls and age ratings please visit eu.playstation.com/parents or go to the Settings section of the User's Guide.

Using the screen

Function screen

Access several features here including your current Trophy details, new notifications, Friends and Settings.

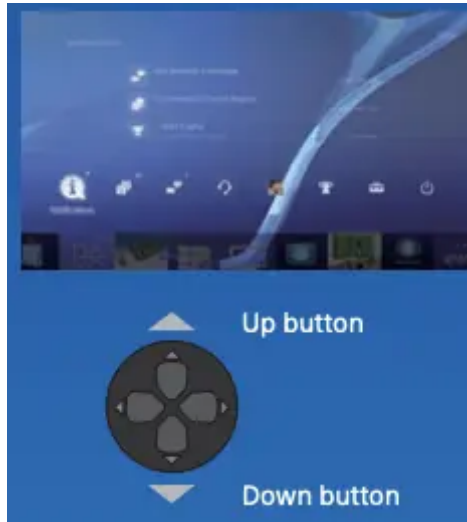

Home screen

Content Area

Access your games and other content. All content is listed from left to right in order of the most recently accessed.



Content info screen

Access the latest information about the currently selected content.



Playing games

1. Insert a disc.

The game will appear in the content area of the home screen.

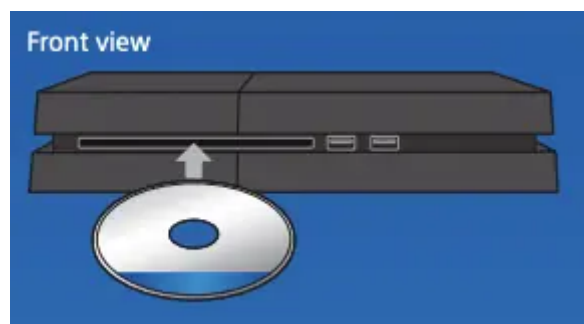

2. Select the game to start playing.

Quitting a game

Press and hold the  (PS) button, and then select [Close Application].

Returning to the home screen from a game

To return to the home screen without quitting a game, press the  (PS) button.

To resume playing the game, select it from the content area.

Removing a disc

Press the  (eject) button.

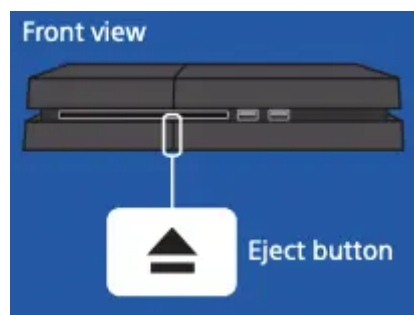

Go to (Play Station Store)

Now that you've got a PS4 system, it's time to head over to see what's available at PlayStationStore.

PlayStationStore has a wide variety of downloadable content, some of which you can't get anywhere else. You'll find games to suit every taste, as well as game add-ons that make your games even more fun to play, plus free demos and much, much more.

And you can even begin playing your games before they've finished downloading.

Sharing your gaming experience

When using some of the PS4 system's online services, you can upload screenshots and video clips of gameplay from a game, and broadcast (stream) your gameplay. Press the SHARE button, and then follow the screens to use this feature.



Sign in to PlayStation Network

Expand your enjoyment of your PS4 system with PlayStation Network. When you sign in to PlayStation Network, you can use a wide variety of features and services.

To sign in to PlayStation Network, you must have a Sony Entertainment Network account and an Internet connection.

Creating an account is free. You can also use an account on the PS4 system that was created using another device, such as a PlayStation3 system or a PlayStationVita system.

PlayStationStore and PlayStation Network subject to terms and country and language restrictions. see eu.playstation.com/legal for details.

Users are responsible for Internet service fees. Users must be 7 years or older and users under 18 require parental consent. Additional age restrictions may apply. Charges apply for some content and/or services. Service availability is not guaranteed.

If you do not have an SEN account

Select  (Settings) > [PlayStation Network/Account Management] > [Sign In to PlayStation Network] from the function screen, and then follow the screens to create an account.

If you already have an SEN account

Select  (Settings) > [PlayStation Network/Account Management] > [Sign In to PlayStation Network] from the function screen. enter your sign-in ID and password. and then select [Sign In]



To create a sub account for users under a certain age. you must first create a master account for a parent or guardian.

Using the controller

Charging

To use your controller wirelessly. you must first charge its battery.

Press and hold the  (PS) button and the controller's battery charge level will be shown on-screen.

1. Turn on your PS4 system (the power indicator will light up  white). or set it to rest mode (the power indicator will light up  orange).
2. Connect your controller to your PS4 system with the USB cable.

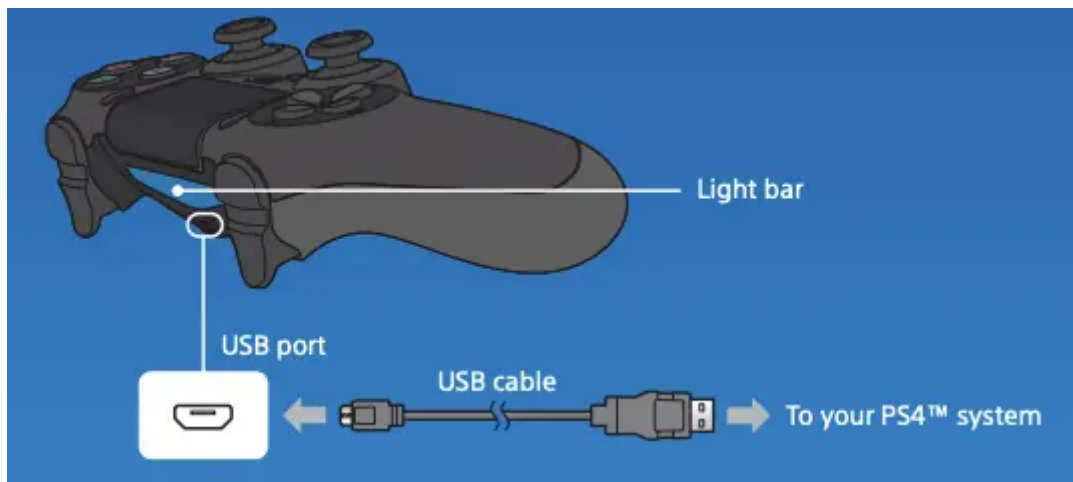

To charge your controller when in rest mode. you must first checkmark the [Supply Power to USB Ports] option in  (Settings) > [Power Saving Settings] > [Set Functions Available in Rest Mode].

Using the mono headset

Connect the mono headset to your controller for in-game voice chat.

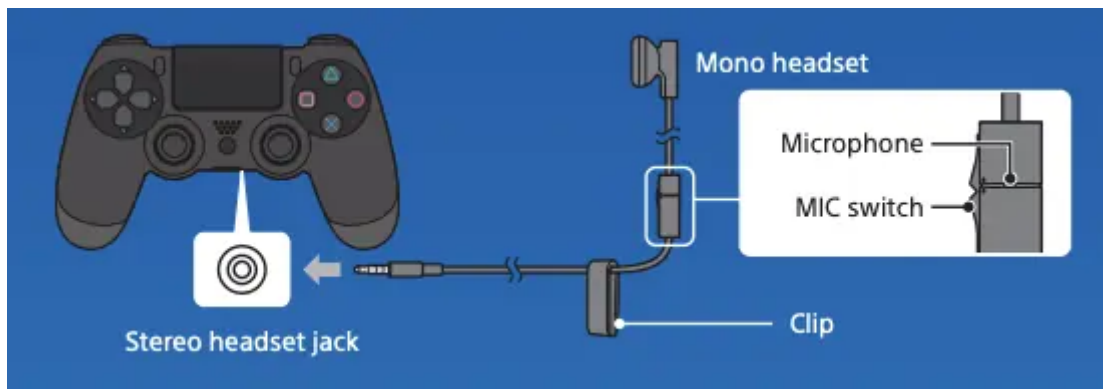

Using multiple controllers

You can use up to 4 controllers at the same time.

When you press the  (PS) button on a controller for which registration has been completed, a colour will be assigned to that user and the light bar will light up in their own colour, depending on the order in which they join in. The first user is blue, the second is red, the third is green and the fourth is pink.

Turning off the power



CAUTION

If you disconnect the AC power cord while the power indicator is lit or blinking, data might be lost or corrupted, or the system might become damaged. You must disconnect the AC power cord only once the power is turned off completely. Be sure to read the "Turning off the power completely" section below.

Entering rest mode



You can charge the controller from a USB port and remain signed in to PlayStation Network while in rest mode.

Select  (Power) from the function screen, and then select [Power Options] > [Enter Rest Mode].

The picture will disappear, and the power indicator will blink  white, before turning  orange.

To exit rest mode, press the  (PS) button.

Turning off the power completely



Select  (Power) from the function screen, and then select [Turn Off PS4]. The picture will disappear, and the power indicator will blink  white, before turning off.

Power indicator status

White	The power is on
Orange	Rest mode
Unlit	The power is off

Further information

User's Guide

The User's Guide contains more information about what your PS4 system can do - including how to adjust settings, how long to charge the controller for and how to use each function. Select  (Settings) >  (User's Guide) from the function screen.

You can also view the User's Guide by visiting: eu.playstation/help/ps4/manuals/

You must have an internet connection to view the User's Guide

Safety Guide

The Safety Guide contains information about how to safely use your PS4 system, and information about specifications. Be sure to read it before using the system.



"PlayStation".



"PS4".



"DUALSHOCK".



and "PS4" are registered

trademarks or trademarks of Sony Computer Entertainment Inc. "SONY" and  are registered trademarks of Sony Corporation. "Sony Entertainment Network" is a trademark of the same company.

The terms HDMI and HDMI High-Definition Multimedia Interface, and the HDMI Logo are trademarks or registered trademarks of HDMI Licensing LLC in the United States and other countries. "Blu-ray Disc" and "Blu-ray" are trademarks of the Blu-ray Disc Association.

Design and specifications are subject to change without notice.

Information about system functionality and images published in this document may vary from those for your system, depending on the system software version in use. Also, the illustrations and screen images used in this guide may vary from the actual product.

The information contained in this manual is subject to change without notice.

Warning

This content is compiled from multiple sources and is provided for reference purposes only. It may not be complete or fully applicable to all situations. If you are unable to resolve your issue, please contact the product manufacturer or an authorized service provider for official support.

Document generated by [ManualsFile](#)

