

OWNER'S MANUAL Mini Hi-Fi System

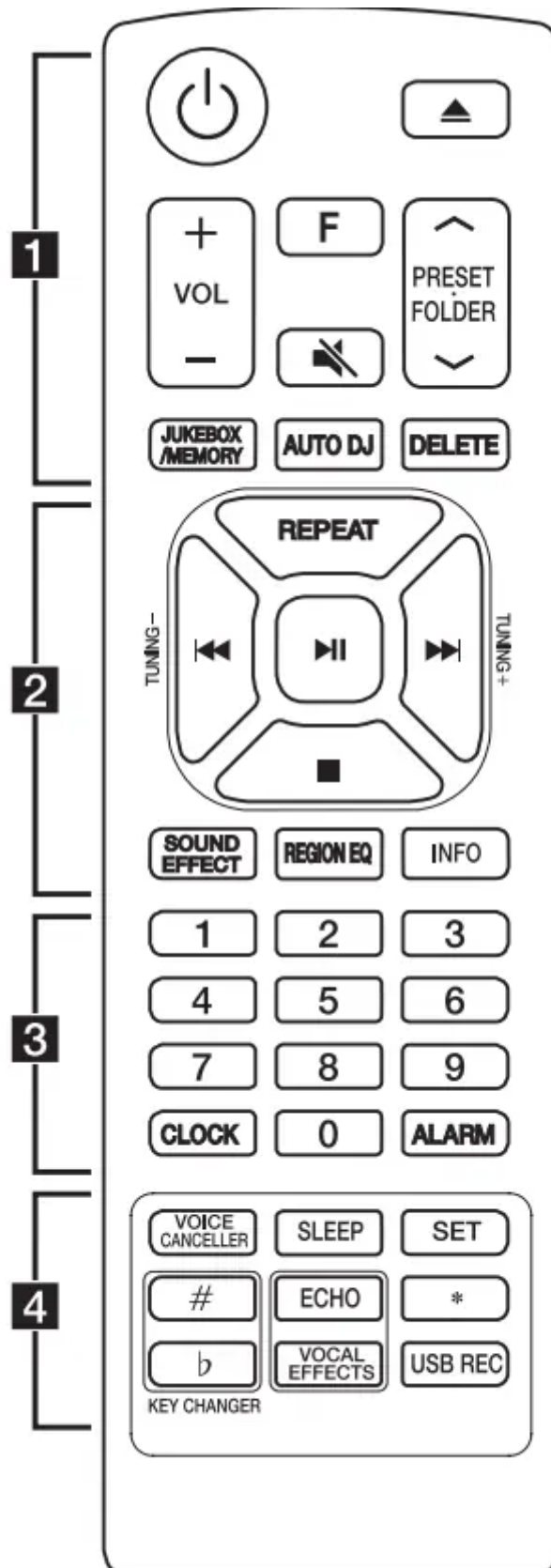

Getting Started

Remote control





Replacement of battery

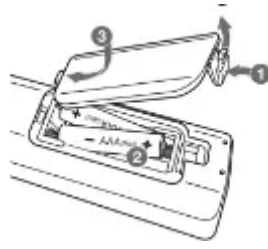



Remove the battery cover on the rear of the remote control, and insert the battery with and matched correctly.

 (Standby) : Turns the power on or off.

 (Open/Close) : Opens and closes the disc tray.

VOL (Volume) +/- : Adjusts speaker volume.

F (Function) : Selects the function and input source.

Input source / Function	Display
Disc	CD
USB	USB1 / USB2
AUX input	AUX
Portable input	PORTABLE
Bluetooth	BT
LG Sound Sync (Wireless)	LG TV
Radio	FM

 (Mute) : Mutes the sound.

PRESET·FOLDER  :

- Chooses a preset number for a radio station. (Page 27)
- Searches for a folder of MP3/WMA files. When a CD/USB containing MP3/WMA files in several folders is being played, press **PRESET·FOLDER ** to select the folder you want to play.

JUKEBOX/MEMORY :

- Stores radio stations. (Page 27)
- Deletes all the saved stations.
- Selects JUKE BOX mode. (Page 31)
- Makes JUKE BOX list.

AUTO DJ : Selects the AUTO DJ mode. (Page 20)

DELETE :

- Deletes MP3/WMA files. (USB only) (Page 19)
- Deletes a song on the JUKE BOX list.



..... **2**

REPEAT : Listens to your tracks/files repeatedly or randomly.

TUNING-/+ : Selects the radio stations.

◀◀/▶▶ (Skip/Search) :

- Skips backward or forward.
- Searches for a section within a track/file.

▶▶ (Play/Pause) :

- Starts or pauses playback.
- Selects stereo/mono.

■ (Stop) :

- Stops playback.
- Cancels DELETE function.

SOUND EFFECT : Chooses sound impressions.

REGION EQ : Chooses region equalizer.

INFO :

- Sees information about your music. An MP3 file often come with ID3 tag. The tag gives the Title, Artist, Album or Time information.
- Sees **Bluetooth** device name of the unit in BT READY.
- Sees the name of connected all **Bluetooth** device in **Bluetooth** mode.
- In status of WIRELESS PARTY LINK connection, device name of SLAVE unit appears in the MASTER unit and device name of MASTER unit appears in the SLAVE unit.

..... **3**

0 to 9 numerical buttons : Selects numbered tracks, files, or preset number.

CLOCK : Sets a clock and checks a time.

ALARM : With the ALARM function you can turn on CD, USB play and tuner reception at a desired time.

..... **4**

VOICE CANCELLER : You can enjoy the function while playing the music, by reducing singer vocal of music in the various source.

SLEEP : Sets the system to turn off automatically at a specified time.
(Dimmer : The display window will be darkened by half.)

SET : Confirms the setting.

KEY CHANGER (#/b) : Changes the key to suit your vocal range.

ECHO : Selects ECHO mode.

***** : This button is not available.

VOCAL EFFECTS : Selects various vocal effects mode.

USB REC : Records to USB.

Front panel

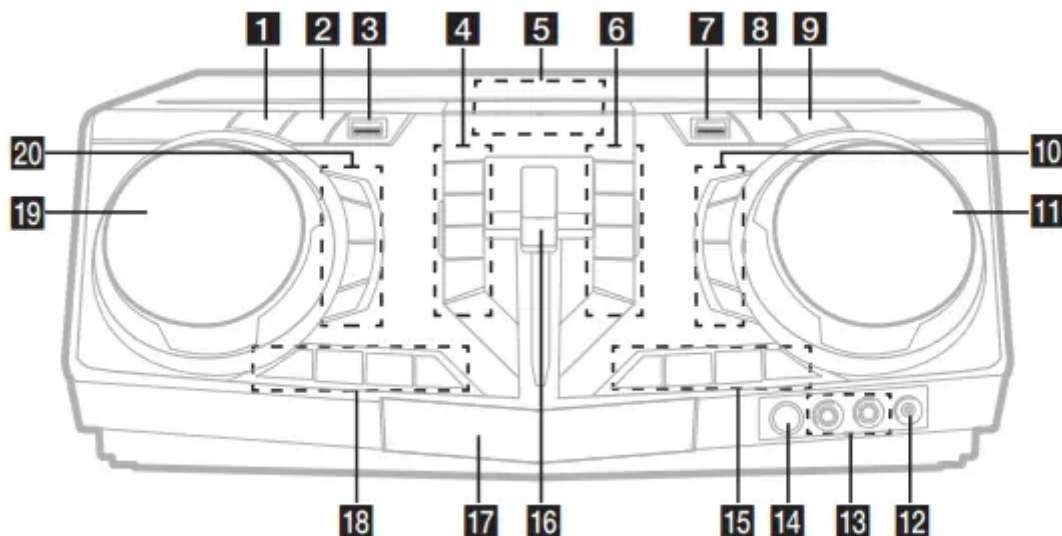

1 (Standby)



Turns the power on or off.

2 USB REC / DEMO

- Records to USB
- To stop Recording, press and hold for 3 seconds.
- In power off status, if you press USB REC / DEMO, show DEMO mode

3 USB 1 Port

You can play sound files by connecting the USB device.

4 PARTY THRUSTER MODE

Selects PARTY THRUSTER mode.

 (Stop)

Stops playback or cancels DELETE function.

 (Skip/Search)

- Skips backward.
- Searches for a section within a track/file.
- Selects the radio stations.

 (Open/Close)

Opens and closes the disc tray

5 Display window

6 DJ LOOP

Selects DJ LOOP mode.

(DJ LOOP mode can use during CD/USB playback.)

 (Play/Pause)

- Starts or pauses playback.
- Selects stereo/mono.

 (Skip/Search)

- Skips forward.
- Searches for a section within a track/file.
- Selects the radio stations.

REGION EQ / BASS BLAST

- Chooses region equalizer.
- Press and hold to select BASS effect directly.

7 USB 2 Port

You can play sound files by connecting the USB device.

8 F (Function)

Selects the function and input source

Input source / Function	Display
Disc	CD
USB	USB1 / USB2
AUX input	AUX
Portable input	PORTABLE
Bluetooth	BT
LG Sound Sync (Wireless)	LG TV
Radio	FM

9 WIRELESS LINK

- Selects MAIN or OTHER on WIRELESS PARTY LINK mode.
- Enable or disable WIRELESS PARTY LINK mode

10 LIGHTING

Turns on/off the lighting effects.

VOCAL EFFECTS

Selects VOCAL EFFECTS mode.

VOICE CANCELLER

You can enjoy the function while playing the music, by reducing singer vocal of music in the various source.

ECHO

Selects ECHO mode.

11 MASTER VOLUME / MULTI JOG

- Adjust speaker volume.
- Selects lighting mode and vocal effects mode.

12 PORT. (Portable) IN jack

13 MIC (Microphone) 1/2 jack

14 (Remote sensor)

15 KEY CHANGER ()

Changes the key to suit your vocal range.

MIC (Microphone) +/-

Adjust microphone volume

16 PARTY THRUSTER lever

Slide up the lever to create a party atmosphere.

17 Disc tray

18 CLUB, DRUM, USER (DJ PRO)

Selects CLUB, DRUM or USER sound effect to mix.

(If you want to use USER, you have to register a source with “Music Flow Bluetooth” app.)

1, 2, 3, 4 (DJ PRO PAD)

Press a desired sound pad.

19 SCRATCH / SEARCH & LEVEL CONTROL

- Turns clockwise or counterclockwise to make scratch sound.
- Turns clockwise or counterclockwise to control the USER EQ level.
- Searches a folder or a file.
- Adjust DJ EFFECT level.

20 DJ EFFECT

Selects a desired DJ EFFECT.

USER EQ

Selects the sound effect created by your own.

SEARCH

Moves to folder or file in selection mode.

OK

Selects a folder when searching a file.



Rear panel

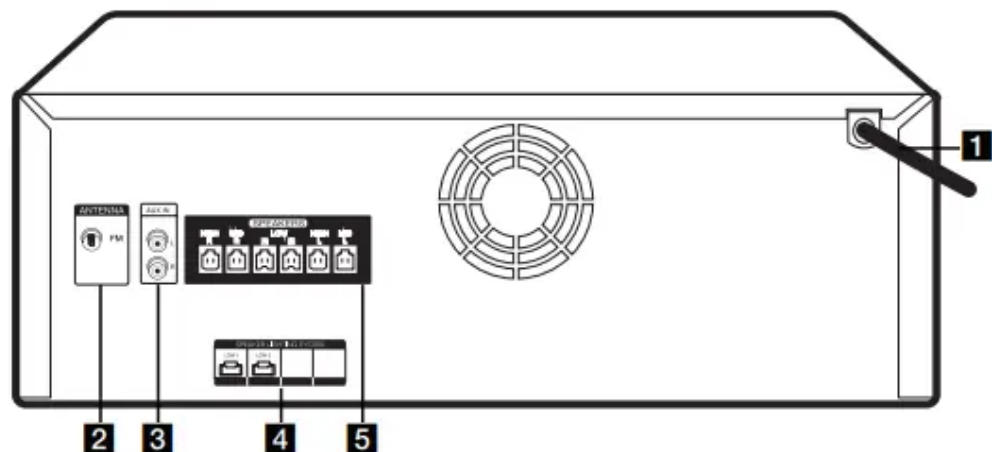

1 Power cord

Caution

- Connect the power cord to wall outlet directly if possible. Or when you use an extension cable, it is highly recommended to use an extension cable of 110 V / 15 A or 230 V / 15 A, otherwise the unit may not operate properly because of the lack of power supply.
- Do not overload the extension cord with excessive electrical load.

2 ANTENNA (FM)

3 AUX IN (L/R)

Connect an auxiliary device.

4 SPEAKER LIGHTING SYSTEM



Connect the speaker lighting cables.

















5 SPEAKERS connector

Operating

Basic Operations

CD/USB Operations

1. Insert the disc by pressing  on the remote control or  on the unit. Or connect the USB device to the USB port
2. Select CD or USB function by pressing F.

To	Do this
Stop	Press  on the remote control or  on the unit.
Playback	Press  on the remote control or  on the unit.
Pause	Press  on the remote control or  on the unit during playback.
Searching for a section within a track/file	Press and hold  on the remote control or  on the unit during playback and release it at the point you want to listen to.
Selecting a track/file directly	Press 0 to 9 numerical buttons on the remote control to go to the desired file or track directly.
Skipping to the next/previous track/file	<p>- In stop status, Press  on the remote control or  on the unit to go to the next/previous track/file.</p> <p>- During playback, Press  on the remote control or  on the unit to go to the next track/file.</p> <p>Playing less than 2 seconds, press  on the remote control or  on the unit to go to the previous track/file.</p> <p>Playing after 3 seconds, press  on the remote control or  on the unit to go to the beginning of the track/file.</p>
Playing repeatedly or randomly	Press REPEAT on the remote control repeatedly. Refer to the note for details about the display change.

Auto Play

- AUDIO/MP3/WMA CD is played automatically after disc tray is opened and then closed.
- Automatically the unit switches to the CD function if disc tray is opened and then closed even when there is no disc in disc tray

Selecting a folder and an MP3/WMA file

On the unit

1. Press SEARCH and rotate SCRATCH / SEARCH & LEVEL CONTROL until a desired file appears. You can also search a folder if you press SEARCH again
2. Press OK or >|| to play the selected file. When you search a folder, press OK to select a file in the folder, then press OK or >|| again. The selected file is played.

On the remote control

1. Press PRESET·FOLDER repeatedly until a desired folder appears.
2. Press ▶|| to play it. The first file of folder will be played

Note

- CD/USB Folders/Files are recognized as below.

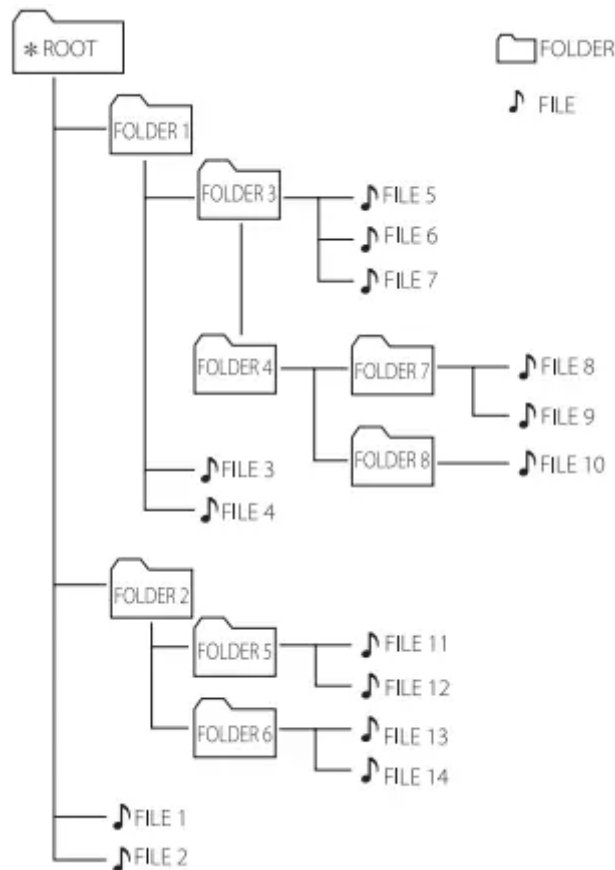

- If there is no file in a folder, the folder will not appear.
- Folders will be presented as the following order; ROOT -> FOLDER 1 -> FOLDER 3 -> FOLDER 7 -> FOLDER 8 -> FOLDER 5 -> FOLDER 6
- File will be played from file No.1 to file No.14 one by one.
- Files and folders will be presented in order recorded and may be presented differently according to the record circumstances.



*ROOT: The first screen you can see when a computer recognize the CD/USB is "ROOT".

Deleting a file/folder or format

You can delete file, folder or format by pressing DELETE on the remote control. This function is supported only in stop status. (USB only)

1. Select USB function by pressing F.

2. Deletes file : Select the file you want to delete and select "DEL FILE" by pressing DELETE on the remote control.

- Deletes folder : Select the folder you want to delete and select "DEL DIR" by pressing DELETE on the remote control.
- Formats USB : Select "FORMAT" by pressing DELETE on the remote control to format the USB device. If you want to exit the current mode, press  on the remote control or  on the unit.

3. To delete file/folder or format, press and hold DELETE on the remote control.

Caution

- Do not extract the USB device during operation. (play, delete, etc.)
- Regular back up is recommended to prevent data loss.
- The delete function may not be supported according to the USB status. (lock, etc.)

Playback Effect

The unit supports various sound and playback effects : DJ EFFECT, SCRATCH, DJ PRO, AUTO DJ, DJ LOOP, PARTY THRUST

DJ EFFECT

It allows you to enjoy DJ EFFECT such as Flanger/Phaser/Wah/Delay sound effect.

1. Press DJ EFFECT on the unit to select a desired DJ EFFECT (FLANGER, PHASER, WAH, DELAY, DJ EFFECT OFF).
2. Turn SCRATCH / SEARCH & LEVEL CONTROL on the unit clockwise or counterclockwise to adjust the DJ EFFECT level between 0 to 15.

SCRATCH

You can output and mix the sound effects of the SCRATCH. Rotating SCRATCH / SEARCH & LEVEL CONTROL on the unit to mix the scratch sound.

- You can hear effect of scratch sound depending on the direction in which you rotate DJ SCRATCH / SEARCH & LEVEL on the unit.

AUTO DJ

Auto DJ blends the end of one song into the beginning of another for seamless playback. It equalizes volume across tracks/files for uninterrupted playback.

Press AUTO DJ on the remote control repeatedly, the display changes as followings.

AUTO DJ RANDOM → AUTO DJ SEQUENTIAL → AUTO DJ OFF

Mode	Display Window	Description
OFF	AUTO DJ OFF	-
RANDOM	AUTO DJ RANDOM	The music is played randomly on this mode.
REPEAT	AUTO DJ SEQUENTIAL	The music is played repeatedly on this mode.

DJ PRO

It allows you to mix CLUB, DRUM or USER sound effect. Each mode has up to 4 sounds effect.

1. Press and hold DJ PRO (CLUB, DRUM or USER) on the unit to select a desired DJ PRO sound effect.
2. Press DJ PRO pad (1, 2, 3, 4) of desired sound on the unit.

DJ LOOP

The certain section (about 1 sec) of sound is repeatedly played. (CD, USB only) During playback, press and hold DJ LOOP on the unit at the point you want. And you can cancel DJ LOOP function by releasing it.

PARTY THRUST

It allows you to create a party atmosphere.

1. Select the mode by pressing PARTY THRUSTER MODE on the unit. The sound effect will react differently according to the mode.

MODE 1 → MODE 2 → MODE 3

2. After selecting the mode, slide up the lever of PARTY THRUSTER on the unit to create a party atmosphere.

The lighting on the speakers, the LED lighting and the sound effect will react according to moving the lever of PARTY THRUSTER on the unit .

OFF → THRUST 1 → THRUST 2 → CLIMAX

Using BLUETOOTH® wireless technology

About Bluetooth

Bluetooth is wireless communication technology for short range connection.

The sound may be interrupted when the connection interfered by the other electronic wave or you connect the Bluetooth in the other rooms.

Connecting individual devices under Bluetooth wireless technology does not incur any charges. A mobile phone with Bluetooth wireless technology can be operated via the Cascade if the connection was made via Bluetooth wireless technology.

- Available Devices: Smart phone, MP3, Notebook, etc.
- Version: 4.0
- Codec: SBC

Bluetooth Profiles

In order to use Bluetooth wireless technology, devices must be able to interpret certain profiles.

This unit is compatible with following profile.

A2DP (Advanced Audio Distribution Profile)

Listening to music stored on the Bluetooth devices

Pairing your unit and Bluetooth device

Before you start the pairing procedure, make sure the Bluetooth feature is activated on your Bluetooth device. Refer to your Bluetooth device's user guide. Once a pairing operation is performed, it does not need to be performed again.

1. Turn on the unit.
2. Operate the Bluetooth device and perform the pairing operation. When searching for this unit with the Bluetooth device, a list of the devices found may appear in the Bluetooth device display depending on the type of Bluetooth device. Your unit appears as "LG CJ98 (XX)"
3. When this unit has successfully connected with your Bluetooth device, "PAIRED" will be appear on the display window. After a short amount of time, the Bluetooth device name will be displayed.
4. Listen to music. To play a music stored on your Bluetooth device, refer to your Bluetooth device's user guide.

Note



- When using Bluetooth technology, you have to make a connection between the unit and the Bluetooth device as close as possible and keep the distance.



However, it may not work well in certain situations as described below:

- There is an obstacle between the unit and the Bluetooth device.
- There is a device using same frequency with Bluetooth technology such as a medical equipment, a microwave or a wireless LAN device.
- You should connect your Bluetooth device to this unit again when you restart it.
- Even if this unit is connected to up to 3 Bluetooth devices in the Bluetooth mode, you can play and control music by using only one of the connected devices.

Bluetooth connection lock (BT LOCK)

You can limit Bluetooth connection to only BT (Bluetooth) and LG TV function to prevent unintended Bluetooth connection.

To turn on this function, press and hold  on the remote control or  on the unit for about 5 seconds in BT (Bluetooth) function. "BT LOCK" appears then you can limit Bluetooth connection.

To turn off this function, press and hold  on the remote control or  on the unit for about 5 seconds in BT (Bluetooth) function. "BT UNLOCK" appears

Radio Operations

Be sure that FM antenna is connected.

Listening to the radio



1. Press F until FM appears in the display window. The last received station is tuned in.
2. Auto tuning: Press and hold TUNING-/+ on the remote control or  on the unit until the frequency indication starts to change, then release. Scanning stops when the unit tunes in a station.

Or

Manual tuning: Press TUNING-/+ on the remote control or  on the unit repeatedly.

3. Adjust the volume by pressing VOL +/- on the remote control or rotating VOLUME knob on the unit repeatedly.

Improving poor FM reception

Press  on the remote control or  on the unit. This will change the tuner from stereo to mono and usually improve the reception.

Presetting the Radio Stations

You can preset 50 stations for FM.

Before tuning, make sure to turn down the volume.

1. Press F until FM appears in the display window.
2. Select the desired frequency by pressing TUNING +/- on the remote control or  on the unit.
3. Press JUKEBOX/MEMORY on the remote control. A preset number will blink in the display window.
4. Press PRESET·FOLDER on the remote control to select the preset number you want.
5. Press JUKEBOX/MEMORY on the remote control. The station is stored.
6. Repeat steps 2 to 5 to store other stations.
7. To listen a preset station, press PRESET·FOLDER or 0 to 9 numerical buttons on the remote control.

Deleting all the saved stations

1. Press and hold JUKEBOX/MEMORY on the remote control for two seconds.
“ERASEALL” will flash up on the unit display
2. Press JUKEBOX/MEMORY on the remote control to erase all the saved radio stations

Sound adjustment

Setting the sound mode

This system has a number of pre-set equalizers. The displayed items for the equalizer may be different depending on sound sources and effects. You can select a desired sound mode by using SOUND EFFECT on the remote control.

On Display	Description
BASS (BASS BLAST)	Reinforces the treble, bass and surround sound effect.
POP CLASSIC ROCK JAZZ	This program lends an enthusiastic atmosphere to the sound, giving you the feeling you are at an actual rock, pop, jazz or classic concert.
FOOT BALL	You can enjoy the sound effect FOOTBALL STADIUM.
STANDARD	You can enjoy optimized sound.

You can select a desired sound mode by using REGION EQ on the remote control or REGION EQ / BASS BLAST on the unit.

On Display	Region	Description
FUNK, REGUETON, SAMBA, MERENGUE, AXE, SALSA, SERTANEJ, FORRO	Latin America	Optimized sound effect for the music genre preferred in each region.
ARABIC	Middle East	
DANGDUT	Indonesia	
AFRO	Africa	
INDIA	India	

Setting the USER EQ

You can adjust the sound level of Bass, Middle and Treble as your preference.

1. Press USER EQ on the unit. "USER EQ" is displayed.
2. Press USER EQ on the unit repeatedly until desired setting appears in the display window.

3. Rotate SCRATCH / SEARCH & LEVEL on the unit to adjust the value.

Advanced Operations

Recording to USB

You can record a various sound source to USB. (CD, USB 1, AUX 1, AUX 2, FM)

1. Connect the USB device to the unit.
2. Press F to select a function you want to record.
3. Start the recording by pressing USB REC on the remote control or USB REC/ DEMO on the unit

Function	Status	Result
CD, USB	Play/Pause	Recorded until stop
	Resume stop (Page 32)	Quick recorded the latest song
	Full stop	Quick recorded All songs In case below, scope is limited. - After File search (Page 18), quick recorded an indexed song - After Folder search (Page 18), quick recorded All songs on Folder - After JUKE BOX On (Page 31), quick recorded All songs of JUKE BOX
AUX, PORTABLE, FM	-	Recorded until stop



- If you connect both USB1 and USB2, press USB REC on the remote control or USB REC / DEMO on the unit when USB1 or USB2 which you want to record blinks in the display window.

4. To stop recording, press and hold USB REC on the remote control or USB REC / DEMO on the unit for 3 seconds. Otherwise, the recording continues.

Pausing recording







During CD/USB playback or pause, or external sound source recording, press USB REC on the remote control or USB REC / DEMO on the unit to pause recording. Press it again to restart recording.

To select recording bit rate

1. Press and hold USB REC on the remote control or USB REC / DEMO on the unit for 3 seconds.
2. Press  on the remote control or  on the unit to select a bit rate.
3. Press USB REC on the remote control or USB REC/ DEMO on the unit again to select the recording speed.

Note

- You can record various sound using DJ EFFECT, SCRATCH, DJ PRO or MIC. (Except when recording USB/ CD that are in stop status.)
- You can control recorded microphone sound according to microphone volume
- You may not store more than 2,000 files.
- In case of the unsupported MP3/WMA file, the file recording may be stopped
- When you are recording during playback, the sound now playing is output.
- It'll be stored as follows.

AUDIO CD	MP3/WMA
Play or pause status  CD_REC AUDIO_0001 AUDIO_0002 : 	Play or pause status  FILE_REC AUDIO_0001 AUDIO_0002 :
The other status  CD_REC TRACK_0001 TRACK_0002 : 	The other status  FILE_REC ABC(File name) DEF(File name) :
The other source*  OTHERS_REC AUDIO_0001 AUDIO_0002 : 	Tuner  TUNERS_REC AUDIO_0001_107-7FM AUDIO_0002_520AM :

* AUX and the like.

Tuner: The current recording frequency is shown

JUKE BOX Playback

JUKE BOX function enables you to make a playlist of your favorite tracks/files from a disc or USB device. A playlist of up to 100 tracks/files can be entered.

Making JUKE BOX list

1. Press and hold JUKEBOX/MEMORY on the remote control to enter the edit mode. (Playing will be stopped when you press JUKEBOX/MEMORY on the remote control.)
2. Select a track/file by pressing  on the remote control.
3. Press and hold JUKEBOX / MEMORY on the remote control to save the track/file.
4. Repeat steps 2 - 3 to store other tracks/files. (You can modify the list by pressing PRESET·FOLDER on the remote control to select the JUKE BOX program number.)
5. Press JUKEBOX / MEMORY on the remote control once again.

To play the JUKE BOX list, press  on the remote control after you make the list.

Deleting JUKE BOX list

1. Press and hold JUKEBOX/MEMORY on the remote control to enter the edit mode.
2. Select a song by pressing PRESET·FOLDER  on the remote control repeatedly
3. Press DELETE on the remote control while a song is selected.

Other Operations

Turn off the sound temporarily

Press  on the remote control to mute your sound.

You can mute your unit, for example, to answer the telephone, the “MUTE” will appear in the display window

To cancel it, press  on the remote control again or change the volume level.

CHILDSAFE Mode

This function helps to prevent you from being surprised when you turn on the unit in case that the volume of the unit is set at a high level.

To turn on CHILDSAFE mode, press and hold OK on the unit when the volume of the unit is “MIN”. In CHILDSAFE mode, the volume increase gradually.



To turn off CHILDSAFE mode, press and hold OK on the unit when the volume of the unit is “MIN” and this mode is turned on.

DEMO

In the power off state, press DEMO on the unit once. The unit will power on and display the each of functions in the display window.

To cancel the DEMO function, press DEMO on the unit once more.

Resume stop

The unit records the point where you pressed the  on the remote control or on the unit depending on the disc or USB. If you press  on the remote control twice or on the unit twice, the unit will clear the stopped point

Using Microphone

1. Connect your microphone to the MIC jack.
2. Play the music you want.
3. Sing along with the accompaniment. Adjust the microphone volume by pressing MIC +/- on the unit.

VOICE CANCELLER

You can reduce the vocal tones during music playback from various input sources.

Press the VOICE CANCELLER and "ON" will appear in display window. To cancel it, press VOICE CANCELLER again. The quality of the VOICE CANCELLER may be different depending on the recording conditions of music files.

KEY CHANGER

You can adjust the key to 9 steps (4 steps higher, 4 steps lower and the original key).

- To sharp the key one by one, press KEY CHANGER(#) repeatedly during playback.
- To flatten the key one by one, press KEY CHANGER() repeatedly during playback.

VOCAL EFFECTS

When you connect your microphone to the MIC jack, you can enjoy karaoke function by changing voice in the various source.

To select various mode, pressing VOCAL EFFECTS repeatedly or pressing VOCAL EFFECTS and then turning MASTER VOL. / MULTI on the unit when vocal effects mode appears in the display window.

BASS -> SOPRANO -> HELIUM -> ROBOT -> DUET MAN -> DUET WOMAN-> BASS ECHO1 -> SOPRANO ECHO1 -> HELIUM ECHO1-> ROBOT ECHO1-> DUET MAN1-> DUET WOMAN1 -> BASS ECHO2 -> SOPRANO ECHO2 -> HELIUM ECHO2 -> ROBOT ECHO2 -> DUET MAN2 -> DUET WOMAN2 -> OFF

ECHO

When you connect your microphone to the MIC jack, you can give an echo effect to the sound from the microphones by pressing MIC ECHO.

ECHO 1 -> ECHO 2 -> ECHO OFF

LIGHTING

This function offers a party atmosphere by operating speaker lighting and beat of music.

To select mode, pressing LIGHTING on the unit repeatedly or pressing LIGHTING on the unit and then turning EQUALIZER / SEARCH on the unit.

OFF->PARTY ->PEACEFUL ->ROMANTIC-> COOL-> UPBEAT-> FIERY ->EXCITED -
>DYNAMIC-> HEALING ->SUNNY-> OFF ...

Sleep Timer Setting

Press SLEEP on the remote control repeatedly to select delay time between 10 and 180 minutes. After the delay time, the unit will be turned off. To cancel the sleep function, press SLEEP on the remote control repeatedly until "OFF" appears.

Dimmer

Press SLEEP on the remote control once. The display window will be darkened by half. To cancel it, press SLEEP on the remote control repeatedly until dim off

Auto power down

This unit will turn itself off to save electricity in the case were the main unit is not connected to an external device and is not used for 15 minutes. The unit will also turn itself off after six hours if the main unit has been connected to another device using the analog inputs.

Auto power down function is applied to only MASTER unit in case of WIRELESS PARTY LINK connection. In case of SLAVE unit, Auto power down is available after disconnection SLAVE unit and MASTER unit.

AUTO POWER On

This unit automatically turns on by an input source : LG TV or Bluetooth When you turn on your TV connected to this unit, this unit recognizes the input signal and selects the suitable function. You can hear the sound from the unit. If you try to connect your Bluetooth device, this unit turns on and connects your Bluetooth device. You can play your music

Auto function change

This unit recognizes input signals such as BT (Bluetooth) and LG TV and then automatically changes to the suitable function.

When you try to connect Bluetooth device

When you try to connect your Bluetooth device to this unit, Bluetooth function is selected. Play your music on the Bluetooth device.

When PORT.IN connection is connected

When you connect the portable device to the PORT. IN connector, PORTABLE function is selected. Play your music on the portable device.

When LG TV is connected

When you turn on your LG TV connected by LG Sound Sync, this unit changes the function to LG TV. You can hear the sound from your TV.

Setting the Clock

1. Turn the unit on.
2. Press and hold CLOCK on the remote control.
3. Select time mode by pressing **⏪/⏩** on the remote control.
 - AM 12:00 (for an AM and PM display) or 0:00 (for a 24 hour display)
4. Press SET on the remote control to confirm your selection.
5. Select the hours by pressing **⏪/⏩** on the remote control.
6. Press SET on the remote control.
7. Select the minutes by pressing **⏪/⏩** on the remote control.
8. Press SET on the remote control.

Using your player as an alarm clock

1. Turn the unit on.
2. Press and hold ALARM on the remote control.
3. Press **⏪/⏩** on the remote control to change the hours and minutes and press SET on the remote control to save.
4. Press **⏪/⏩** on the remote control to select function and press SET on the remote control to save.
 - Press **⏪/⏩** on the remote control to select a preset number when you select tuner and then, press SET on the remote control. If there is no preset number, this step is skipped.
5. Press **⏪/⏩** on the remote control to change the volume and press SET on the remote control to save.

LG Sound Sync

You can control some functions of this unit by your TV's remote control with LG Sound Sync. It is compatible with LG TV that supports LG Sound Sync. Make sure your TV has the LG Sound Sync logo. Controllable function by LG TV's remote control: Volume up/down, mute.

Refer to the TV's instruction manual for the details of LG Sound Sync.

1. Turn on the unit by pressing .
2. Press F until LG TV function is selected.
3. Set up the sound output of TV to listen to the sound through this unit:

TV setting menu [Sound] -> [TV Sound output] -> [LG Sound Sync (Wireless)]

“PAIRED” appears on the display window for about 3 seconds and then you can see “LG TV” on the display window if the TV and this unit are connected normally.

Troubleshooting

General

The unit does not work properly

- Turn off the power of this unit and the connected external device (TV, Woofer, DVD-player, Amplifier, etc.) and turn them on again.
- Disconnect the power cord of this unit and the connected external device (TV, Woofer, DVD-player, Amplifier, etc.) and then try connecting again.
- Previous setting may not be saved when device power is shut off.

No Power

- The power cord is not plugged in. Plug in the power cord.
- Check whether electricity failed. Check the condition by operating other electronic devices using the same AC outlet.

No sound

- Check whether you select right function. Press function button and check if you have selected the right function.
- Check to see if the speakers are connected correctly. Speaker cables connected correctly.

The unit does not start playback

- An unplayable disc is inserted. Check the playable disc.
- No disc is inserted. Insert a disc.
- The disc is dirty. Clean the disc.
- The disc is inserted upside down. Place the disc with the label or printed side facing upwards.

Radio stations cannot be tuned in properly

- The antenna is positioned or connected poorly. Connect the antenna securely.
- The signal strength of the radio station is too weak. Tune to the station manually.

- No stations have been preset or preset stations have been cleared (when tuning by scanning preset channels). Preset some radio stations .

The remote control does not work properly

- The remote control is too far from the unit. Operate the remote control within about 7 m.
- There is an obstacle in the path of the remote control and the unit. Remove the obstacle.
- The batteries in the remote control are exhausted. Replace the batteries with new ones.

LG Sound Sync does not work

- Check whether your LG TV supports LG Sound Sync.
- Check connection of LG Sound Sync.
- Check sound setting of your TV and this unit.

No speaker light

- Check whether the speaker light cables are connected to the unit correctly. Connect the speaker light cables to the unit correctly.
- Check the speaker light effects by pressing LIGHTING on the unit.

Warning

This content is compiled from multiple sources and is provided for reference purposes only. It may not be complete or fully applicable to all situations. If you are unable to resolve your issue, please contact the product manufacturer or an authorized service provider for official support.