

## Operating Instructions

### About the controls on your Zoneline



### Controls

#### 1. Temp Control

The temp control is used to maintain the room temperature. The compressor will cycle on and off to keep the room at the same level of comfort.

Press the ▲ pad to raise the temperature.

Press the ▼ pad to lower the temperature.

**NOTE:** The display shows the set temperature, not the room temperature.

#### 2. Sleep

Press to set the air conditioner to run for 8 hours before it automatically returns to the previous setting. When in the cooling mode and the sleep timer is set, the set temperature will automatically increase 2°F after the second hour then 1°F each hour over the next two hours. Also, the fan speed will change to low.

When in the heating mode, the set temperature will decrease in the same manner.

To cancel the sleep mode, press the MODE pad or the SLEEP pad a second time.

#### Fan, Mode and Operation Control

**FAN**—Sets the fan operation for **HIGH**, **LOW** or **AUTO** speed. When set at **AUTO**, it automatically switches between **LOW** and **HIGH** as room temperature changes.

**MODE—COOL**—For cooling

**FAN**—For fan-only operation

**HEAT**—For heating

**OPERATION—ON/STOP**—Turns the unit on or off. Power remains connected to the

Zoneline. The Freeze/Heat Sentinel features still function if active. See the freezer/Heat sentinel section on page 6.

**NOTE:** the temperature display will flash to indicate a possible unit malfunction. set operation control to STOP and then restart the unit. if the flashing light reappears within 30 minutes, call for service.

### **Quick Heat Recovery**

Activates each time the thermostat is switched from **STOP** or **COOL** mode to **HEAT** mode. Electric heaters are energized until the thermostat set point is reached. On heat pump models, the heat pump operation will resume at the next call for heat.

#### About Your Heat Pump (6100 Series only)

Heat pumps can save money by removing heat from the outside air—even when the outside temperature is below freezing—and releasing that heat indoors.

To get the best performance from your heat pump, don't change the room thermostat very often. Raising the heat setting 2–3 degrees will cause the Zoneline to use its electric heating elements in order to reach the new temperature setting quickly.

There is a 3-minute minimum compressor run time at any setting to prevent short cycling.

The indoor fan motor starts before the compressor and stops after the compressor cycles off.

When the outdoor temperature is lower than 25°F, heat is provided by the electric heater in the air conditioner instead of by the heat pump.

The electric heating elements use much more electricity than heat pumps and cost more to operate.

### **Other features of your Zoneline**

#### **Ventilation Control**

**NOTE:** two shipping screws must be removed from the vent door before use. see the installation instructions in the back of this manual. if you do not plan to use the ventilation feature, leave these two screws in place.

The ventilation control lever is located at the middle left side of the Zoneline unit, behind the room cabinet.

When set at the closed position, only the air inside the room is circulated and filtered.

When set at the open position, some outdoor air will be drawn into the room. This will reduce the heating or cooling efficiency.

**Energy Tip:** Keep the vent control in the closed position. The room air will be filtered and circulated.



### To Remove the Room Cabinet

Additional controls are located behind the room cabinet.

**To remove:** Pull out at the bottom to release it from the tabs (1). Then lift up (2).





**To replace:** Place the tabs over the top rail (1). Push inward at the bottom until it snaps into place (2).



### **Air Direction**

To change the air direction, remove the room cabinet. Remove the 7 louver screws that hold the louver insert in place. Flip the louver insert 180°, replace the screws and the room cabinet.

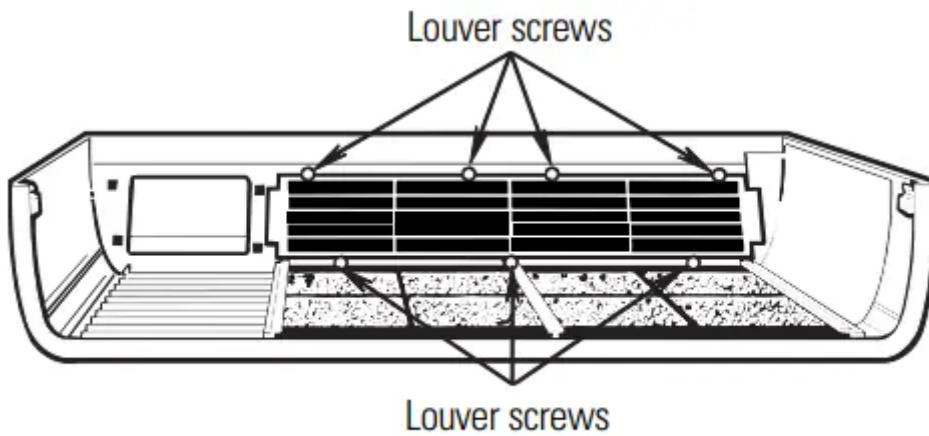

*Remove the room cabinet and flip the louver insert to change the air direction.*



## **Auxiliary controls on your Zoneline**

### **Auxiliary Controls—Aux Set Button**

The auxiliary set controls are located behind the room cabinet, below the control panel.

Remove the room cabinet. See the to Remove the Room Cabinet section.

The owner is responsible for ensuring the auxiliary controls are set to the desired function. There are 9 different modes that can be set using the auxiliary set button. To change modes, press **AUX SET** (“AU” appears on the display). Press the mode button on the control pad until the first digit in the display shows the number corresponding to the mode you are choosing and the correct HEAT/ COOL LED is lit. Press the up or down arrow (shown in the second digit of the display) to make the mode setting selection where applicable. Press the **AUX SET** button to confirm the selection.

## Auxiliary Set Button



### MODE 1 Smart Fan—Cooling/Heating

The default setting for Mode 1 is as follows:

Cooling: Continuous (ON)



Heating: Cycle (OFF)

Press **MODE** until a 1 appears in the first digit of the display for **Smart Fan** cool mode. The **COOL** LED light on the main control will be on. To change to heat mode, press **MODE** again. The **HEAT** LEDlight on the main control will be lit. Press the down arrow to set the indoor fan to cycle on/off

when the unit is heating or cooling "  " Press the up arrow to set the indoor fan to run

continuously "  " This is shown in the second digit of the display. Press **AUX SET** to



confirm your selection and exit **AUX SET** mode, or press **MODE** to continue setting other functions.

	— HIGH	 COOL
	— LOW	— FAN
	— AUTO	— HEAT



Cooling – Cycle\*

	— HIGH	 COOL
	— LOW	— FAN
	— AUTO	— HEAT

Cooling – Continuous

	— HIGH	— COOL
	— LOW	— FAN
	— AUTO	 HEAT

Heating – Cycle\*

	— HIGH	— COOL
	— LOW	— FAN
	— AUTO	 HEAT

Heating – Continuous

**Note:** In cyclic cooling mode, the indoor fan will activate occasionally to verify airtemperature in the room. In cyclic heating mode, the fan will continue to operate for 90seconds after the heating function has stopped in order to increase unit efficiency.

**MODE 2 Load Shedding (Central Desk Control)**

The default setting for Mode 2 is OFF.

This feature is active only ifthe unitis connected to a CDC and the CDC has control. Press **MODE** until a 2 appears in the first digit ofthe display for **Load Shedding** mode. Press the down arrow for



OFF"  "or the up arrow for ON"  ". This is shown in the second digit of the display. When this mode is on, only the indoor fan can be turned ON or OFF with the unit controls. When this mode is off, all operation is disabled except Heat/Freeze Sentinel (Mode 3). Press **AUX SET** to confirm your selection and exit **AUX SET** mode, or press **MODE** to continue setting other functions.



Load  
Shedding  
OFF



Load  
Shedding  
ON

### MODE 3 Freeze Sentinel/Heat Sentinel

In the default setting for Mode 3, **Heat Sentinel** is off, **Freeze Sentinel** is on.

Press **MODE** until a 3 appears in the first digit of the display for **Freeze Sentinel** mode. The **COOL** LEDlight on the main control will be on. Press **MODE** again to change to the Heat Sentinel. The

**HEAT** LEDlight on the main control will be on. Press the down arrow for OFF"  " or the up

arrow for ON"  ". This is shown in the second digit of the display. Press **AUX SET** to confirm your selection and exit **AUX SET** mode, or press **MODE** to continue setting other functions.

When **Freeze Sentinel** is activated, it automatically provides heat without user interface. This helps to prevent plumbing damage by turning the heater and indoor fan ON at 41°F and OFF at 46°F.

When **Heat Sentinel** is activated, it automatically provides cooling without user interface. This helps to prevent an excessively hot room by turning the air conditioner ON at 85°F and OFF at 80°F.

**NOTE:** These functions are active whenever the unit is plugged in, even if the unit is in the STOP position.



**MODE 4 Constant ON Fan**

The default setting for Mode 4 is OFF.

Press **MODE** until a 4 appears in the first digit of the display to set the fan to run continuously at

high speed, even if the unit is in the STOP position. Press the down arrow for OFF"  " or

the up arrow for ON"  ". This is shown in the second digit of the display. Press **AUX SET** to confirm your selection and exit **AUX SET** mode, or press **MODE** to continue setting other functions.





Constant  
Fan OFF



Constant  
Fan ON

### MODE 5 Temperature Limiting

The default setting for Mode 5 is as follows: Cool: 2 (66°F to 85°F) Heat: 5 (60°F to 78°F)

Press **MODE** until a 5 appears in the first digit of the display for **Temperature Limiting** cool mode. The **COOL** LEDlight on the main control will be lit. To change to heat mode, press **MODE** again and the **HEAT** LEDlight on the main control will be lit. To set the temperature limits, press the up or down arrow keys. The second digit of the display will be between 0 and 7 depending on the limit you want to set. The chart shows the limits available. Press **AUX SET** to confirm your selection and exit AUX SET mode, or press **MODE** to continue setting other functions.

—	HIGH	■	COOL
—	LOW	—	FAN
—	AUTO	—	HEAT

Temperature Limiting Cool – Limit 2

—	HIGH	—	COOL
—	LOW	—	FAN
—	AUTO	■	HEAT

Temperature Limiting Heat – Limit 3



Temperature limits—Cool	Temperature limits—Heat
0 = 60°F to 85°F	0 = 60°F to 65°F
1 = 64°F to 85°F	1 = 60°F to 70°F
2 = 66°F to 85°F	2 = 60°F to 72°F
3 = 68°F to 85°F	3 = 60°F to 74°F
4 = 70°F to 85°F	4 = 60°F to 76°F
5 = 72°F to 85°F	5 = 60°F to 78°F
6 = 74°F to 85°F	6 = 60°F to 80°F
7 = 76°F to 85°F	7 = 60°F to 85°F

### MODE 6 Remote Thermostat – Class 2

The default setting for Mode 6 is OFF.

Setting this mode to ON will allow the unit to operate with a Class 2 Remote Control Wall Thermostat. Press **MODE** until a 6 appears in the first digit of the display for **Class 2** mode. Press

the down arrow to turn the option OFF"  " Press the up arrow to turn this option

ON"  ". This is shown in the second digit of the display. Press **AUX SET** to confirm your selection and exit **AUX SET** mode, or press **MODE** to continue setting other functions.



Class 2 OFF



Class 2 ON

### MODE 7 Duct Mode

The default setting for Mode 7 is OFF. This setting is used when the unit is installed using a duct adapter kit. If the unit is ducted, the Duct Mode needs to be set to ON. This increases the fan speed to ensure proper circulation.

Press **MODE** until a 7 appears in the first digit of the display. Press the up or down arrow keys to

set this switch to OFF"  " or ON"  ". This is shown in the second digit of the display.

Press **AUX SET** to confirm your selection and exit **AUX SET** mode.

For Model AZ6100, press **MODE** to continue setting other functions. Pressing **MODE** on Model AZ4100 will return you to **AUX SET** mode and an "AU" will appear in the display.



### **MODE 8 All-Electric Heat (AZ6100 only)**

The default setting for Mode 8 is OFF.

This electric heat option functions only on the 6100 model. When this option is ON"  " heat pump operation is locked out, causing the unit to provide only electric resistance heat.

To set **All-Electric Heat** option, press **MODE** until an 8 appears in the first digit of the display.

Press the up or down arrow keys to set this switch to OFF"  " or ON"  ". This is shown in the second digit of the display

Press **AUX SET** to confirm your selection and exit **AUX SET** mode, or press **MODE** to continue setting other functions.

### **MODE 9 Heat Boost (AZ6100 only)**

The default setting for Mode 9 is OFF.

When **Heat Boost** is ON and outer temperatures are between 25°F and 46°F, heat pump only operation is locked out. This setting is used to provide supplementary heat to the heat pump operation by electric resistance heat in conditions where the heat pump-only operation is not sufficient to maintain a consistent, comfortable room temperature.

**NOTE:** Temperature Boost option should not be used with remote thermostat operation. This will cause the unit to switch to resistance heat when the outdoor temperature is 46°F.

To set Heat Boost, press **MODE** until a 9 appears in the first digit of the display. Press the up or

down arrow keys to set this switch to OFF"  " or ON"  ". This is shown in the second digit of the display. Press **AUX SET** to confirm your selection and exit **AUX SET** mode.

### **Auxiliary Controls—Terminal Connections**

The auxiliary controls are located behind the room cabinet beneath the access cover.

1. Turn off and unplug the unit.
2. Remove the room cabinet. See the to Remove the Room Cabinet section.



3. Remove the screw from the access cover.
4. To make wiring connections, insert the wires into the bottom of the terminals and tighten screws securely.
5. After all desired connections have been made, replace the access cover and room cabinet.

The owner is responsible for making all connections and setting the appropriate AUX SET mode.

**CAUTION:** Improper wiring may damage the Zoneline electronics. No common busing is permitted. Damage or erratic operation may result. A separate wire pair must be run from each separate controlling switch to each individual Zoneline.



### External Fan (Obtained locally)

When connected, an auxiliary or external fan can be controlled with the indoor fan motor on the Zoneline. Connections provide 24 V AC to energize a remote relay, turning on the external fan.



### Central Desk Control



When connected, the unit can be turned ON or OFF with a switch located at the Central Control Panel. A separate wire pair must be run from each separate controlling switch to each individual Zoneline. Refer to MODE 2 on page 5 for fan setting options.



### Remote Thermostat

When connected to a remote thermostat, the indoor air temperature sensing is shifted from the unit to the remote thermostat. For this reason, the units will operate slightly differently when connected to a remote thermostat. The following chart shows the unit operation when connected to a remote thermostat.

**NOTE:** The Class 2 Mode setting (Mode 6) must be set to ON "  " for the unit to operate with a Class 2 Remote Wall Thermostat. (See the installation instructions supplied with the remote thermostat and Mode instructions on page 7.)



Class 2 Shown ON



**IMPORTANT:** The Zonline thermostat connections provide 24 V AC only. If using a digital/ electronic wall thermostat, you must set it to the 24 V AC setting. See the Installation Instructions for the wall thermostat.

**CAUTION:** Damage to a wall thermostat or to the Zonline electronics can result from improper connections. Special care must be used in connecting the wires. No line voltage connections should be made to any circuit. Isolate all wires in building from line voltage.

Feature	Heat Pump	Electric Heat
Indoor Frost Control	Yes	Yes
Freeze Sentinel	Yes	Yes
Auto Fan Speed	No	No
Electronic Temperature Limiting	No	No
Switch to Resistance Heat Based On Indoor Temperature	Determined by Remote Thermostat	N/A
Switch to Resistance Heat Based On Outdoor Temperature	Yes	N/A
Reverse Cycle Defrost	Yes	N/A
Simultaneous Resistance Heat with Heat Pump	No	N/A
Resistance Heat Lockout	Yes	N/A
"Smart Fan" Fan Cycle	Fan ON/AUTO Set On Remote Thermostat	Fan ON/AUTO Set On Remote Thermostat
Central Desk Control	Yes	Yes



## Care and cleaning

### Room Cabinet and Case

Turn the Zoneline off and disconnect the power supply.

To clean, use water and a mild detergent. Do not use bleach or abrasives. Some commercial cleaners may damage the plastic parts.

### Outdoor Coils

The coils on the outdoor side of the Zoneline should be checked regularly. If they are clogged with dirt or soot, they may be professionally steam cleaned. You will need to remove the unit from the wall sleeve to inspect the coils. The dirt buildup occurs on the fan side of the outdoor coil.



Clean the outside coils regularly.

### Base Pan

In some installations, dirt or other debris may be blown into the unit from the outside and settle in the base pan (the bottom of the unit).

In some areas of the United States, a naturally occurring “gel-like” or “slime-like” substance may be seen in the base pan. Check it periodically and clean, if necessary.

## Ventilation Filter

If the vent door is open, access requires the removal of the unit from the wall sleeve. Clean the vent filter twice a year or as required.

Turn the Zoneline off and unplug before cleaning.



### To clean the vent filter:

**IMPORTANT:** This filter is not removable. Trying to remove this filter will damage the unit.

- Use a vacuum to remove debris from the filter.
- Use a damp rag to wipe down the filter and surrounding area after vacuuming.

To maintain optimum performance, clean the filters at least every 30 days.

## Air Filters



*Dirty filter—Needs cleaning*

*Clogged filter—Greatly reduces cooling, heating and airflow.*

### **Turn the Zoneline off before cleaning.**

The most important thing you can do to maintain the Zoneline is to clean the filter at least every 30 days. Clogged filters reduce cooling, heating and air flow.

### **Keeping these filters clean will:**

- Decrease cost of operation.
- Save energy.
- Prevent clogged heat exchanger coils.
- Reduce the risk of premature component failure.

### **To clean the air filters:**

- Vacuum off the heavy soil.
- Run water through the filters from the back side.
- Dry thoroughly before replacing.

**NOTE:** The air filters are interchangeable and will fit in either the right or left side.

### **To remove the air filters:**



To replace the air filters:



**CAUTION: Do not operate the Zoneline without the filters in place. If a filter becomes torn or damaged, it should be replaced immediately.** Operating without the filters in place or with damaged filters will allow dirt and dust to reach the indoor coil and reduce the cooling, heating, airflow and efficiency of the unit. Replacement filters are available from your salesperson, GE dealer, GE Service and Parts Center or authorized Customer Care® servicers.

## **TROUBLESHOOTING TIPS**

### **Before you call for service...**

Troubleshooting tips

Save time and money! Review the charts on the following pages first and you may not need to call for service.

Problem	Possible Causes	What To Do
<p><b>Zoneline does not start</b></p>	<p><b>The unit is unplugged.</b></p> <hr/> <p><b>The power cord is not firmly attached.</b></p> <hr/> <p><b>The fuse is blown/ circuit breaker is tripped.</b></p> <hr/> <p><b>The unit is waiting for the compressor overload protector to reset.</b></p> <hr/> <p><b>Power failure.</b></p> <hr/> <p><b>The current interrupter device is tripped.</b></p>	<ul style="list-style-type: none"> <li>• Make sure the Zoneline plug is pushed completely into the outlet.</li> </ul> <hr/> <ul style="list-style-type: none"> <li>• Remove the room cabinet and make sure that the yellow connector on the end of the power cord is firmly engaged.</li> </ul> <hr/> <ul style="list-style-type: none"> <li>• Check the house fuse/circuit breaker box and replace the fuse or reset the breaker.</li> </ul> <hr/> <ul style="list-style-type: none"> <li>• This is normal. The Zoneline will start again after it resets.</li> </ul> <hr/> <ul style="list-style-type: none"> <li>• If power failure occurs, set the mode control to STOP. When power is restored, set the mode control to the desired setting.</li> <li>• There is a protective time delay (up to 3 minutes) to prevent tripping of the compressor overload. For this reason, the unit may not start normal heating or cooling for 3 minutes after it is turned back on.</li> </ul> <hr/> <ul style="list-style-type: none"> <li>• Press the RESET button located on the power cord plug or the box near the plug.</li> <li>• If the RESET button will not stay engaged, discontinue use of the Zoneline and contact a qualified service technician.</li> </ul>
<p><b>Zoneline does not cool or heat as it should</b></p>	<p><b>Indoor airflow is restricted.</b></p> <hr/> <p><b>Outdoor airflow is restricted or recirculated.</b></p>	<ul style="list-style-type: none"> <li>• Make sure there are no curtains, blinds or furniture blocking the front of the Zoneline.</li> </ul> <hr/> <ul style="list-style-type: none"> <li>• Make sure the rear grille is not restricted. This can cause the unit to</li> </ul>



	<p><b>The temp control may not be set properly.</b></p> <hr/> <p><b>The air filter is dirty.</b></p> <hr/> <p><b>The room may have been hot or cold.</b></p> <hr/> <p><b>Outdoor air is entering the room.</b></p>	<p>cycle off due to the compressor overload protector.</p> <ul style="list-style-type: none"> <li>• Outdoor grille must have a minimum of 65% free area. Non-GE grilles may be too restrictive for proper performance. Consult your salesperson for assistance.</li> </ul> <hr/> <ul style="list-style-type: none"> <li>• Turn the control to a lower or higher setting. <b>NOTE:</b> the temperature limiter may be limiting the temperature range.</li> </ul> <hr/> <ul style="list-style-type: none"> <li>• Clean the filter at least every 30 days. See the operating instructions section.</li> </ul> <hr/> <ul style="list-style-type: none"> <li>• When the Zoneline is first turned on you need to allow time for the room to cool down or warm up.</li> </ul> <hr/> <ul style="list-style-type: none"> <li>• Set the vent control to the closed position.</li> </ul>
<p><b>Burning odor at the start of heating operation.</b></p>	<p><b>Dust is on the surface of the heating element.</b></p>	<ul style="list-style-type: none"> <li>• This can cause a “burning” odor at the beginning of the heating operation. This odor should quickly fade.</li> </ul>
<p><b>The air is not always cool or hot during operation</b></p>	<p><b>The heat pump is not producing hot air.</b></p> <hr/> <p><b>The Smart Fan Auxiliary Controls may be set to continuous fan.</b></p>	<ul style="list-style-type: none"> <li>• This is normal. The heat pump will produce warm air but not as hot as air produced when the higher-cost electric heat is used.</li> </ul> <hr/> <ul style="list-style-type: none"> <li>• This causes the fan to blow room temperature air even when the compressor or heater cycles off. The continuous air movement provides better overall temperature control in the cool mode. See smart fan – Cooling/Heating on page 5.</li> </ul>



<p><b>The air does not feel warm enough during heating operation</b></p>	<p><b>The heat pump alone produces air that feels cooler than desired.</b></p>	<ul style="list-style-type: none"> <li>• Use the Electric Heat Option. This turns off the heat pump and warms with electric heat only. <b>NOTE:</b> use of this option will result in increased energy consumption.</li> </ul>
<p><b>The unit is not blowing out air</b></p>	<p><b>The Smart Fan Auxiliary Controls may be set to cycle.</b></p>	<ul style="list-style-type: none"> <li>• See smart fan – Cooling/Heating on page 5.</li> </ul>
<p><b>The electric heating feature does not work</b></p>	<p><b>The power cord is not firmly attached.</b></p>	<ul style="list-style-type: none"> <li>• Remove the room cabinet and make sure that the yellow connector on the end of the power cord is firmly engaged.</li> </ul>
<p><b>Temperature display flashes</b></p>	<p><b>The compressor may have failed</b></p>	<ul style="list-style-type: none"> <li>• Set the operation control to <b>STOP</b> and then restart the unit. If the flashing light reappears within 30 minutes, call for service.</li> </ul>

## Things that are normal

### Normal Operating Sounds

	<p>You may hear a pinging noise caused by water being picked up and thrown against the condenser on rainy days or when the humidity is high. This design feature helps remove moisture and improve efficiency.</p>
	<p>You may hear relays click when the controls cycle on and off or are adjusted to change the room temperature.</p>
	<p>Water will collect in the base pan during high humidity or on rainy days. The water may overflow and drip from the outdoor side of the unit.</p>
	<p>The indoor fan runs continuously when the unit is operating in the cooling mode, unless the Smart Fan Auxiliary Control is set to cycle. This will cause the fan to cycle on and off with the compressor. You may also hear a fan noise stop and start.</p> <p>There are times when the fan on the unit will run even when the unit is not heating or cooling. If the system is set up to be in continuous fan the indoor fan will run regardless if the unit may be cooling or heating. Other times the fan will run longer than the heating/cooling cycle or kick on occasionally. This is normal and is done to improve room comfort and balance.</p>
	<p>You may notice a few minutes delay in starting if you try to restart the Zoneline too soon after turning it off or if you adjust the thermostat right after the compressor has shut off. This is due to a built-in restart protector for the compressor that causes a 3-minute delay.</p>
	<p>During the defrost cycle, both indoor and outdoor fans stop and the compressor will operate in the cooling mode to remove frost from the outdoor coil. After defrost, the unit will restart in electric heat to quickly warm the room to the desired comfort level.</p>
	<p>To protect the compressor and prevent short cycling, the unit is designed to run for a minimum of 3 minutes after the compressor starts at any thermostat setting.</p>

**Warning**

This content is compiled from multiple sources and is provided for reference purposes only. It may not be complete or fully applicable to all situations. If you are unable to resolve your issue, please contact the product manufacturer or an authorized service provider for official support.

