

Before using for the first time

Opening the door

- Pull the handle to open the door. If the door is opened during operation, all functions are automatically interrupted.

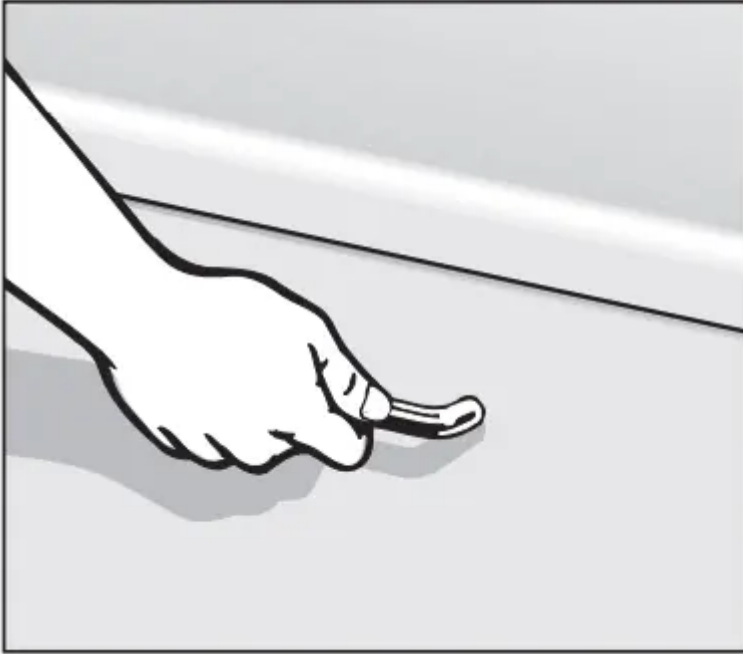

WARNING: Water in the dishwasher may be hot. Danger of scalding! Only open the door during operation if absolutely necessary and exercise extreme caution when doing so.

Closing the door

- Push the baskets in.
- Then lift the door upwards and push until it clicks into position.

WARNING: Danger of crushing injuries! Do not put your hand inside the door as it is closing.

Rinse aid

Rinse aid is needed to prevent spotting on dishes and glassware. The rinse aid is filled in the reservoir and the set amount will be automatically dosed.

WARNING: Filling the rinse aid reservoir with detergent will damage the reservoir. Only pour rinse aid formulated for residential dishwashers into the reservoir. When using “Tab” detergents rinse aid is not needed.

Adding rinse aid

- Press the button on the lid of the rinse aid reservoir in the direction of the arrow until the flap springs open.

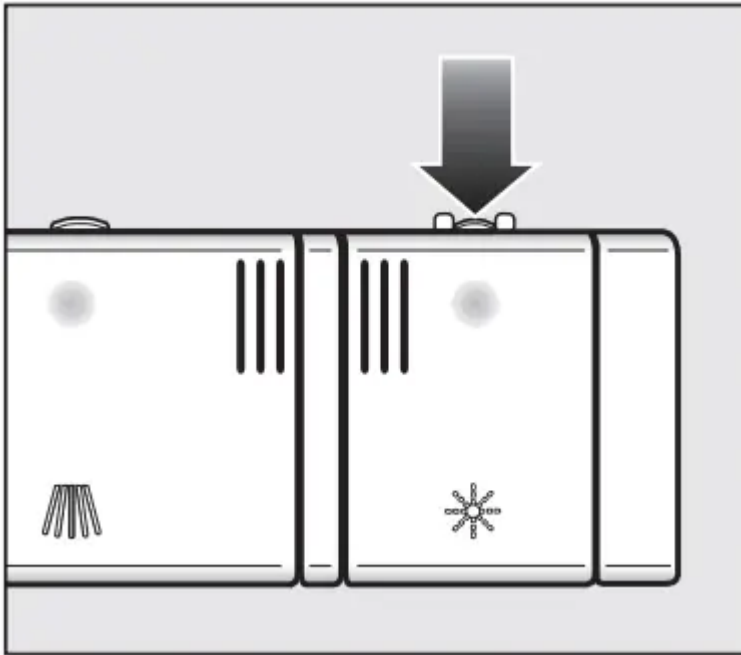

- Add rinse aid only until it is visible in the opening.

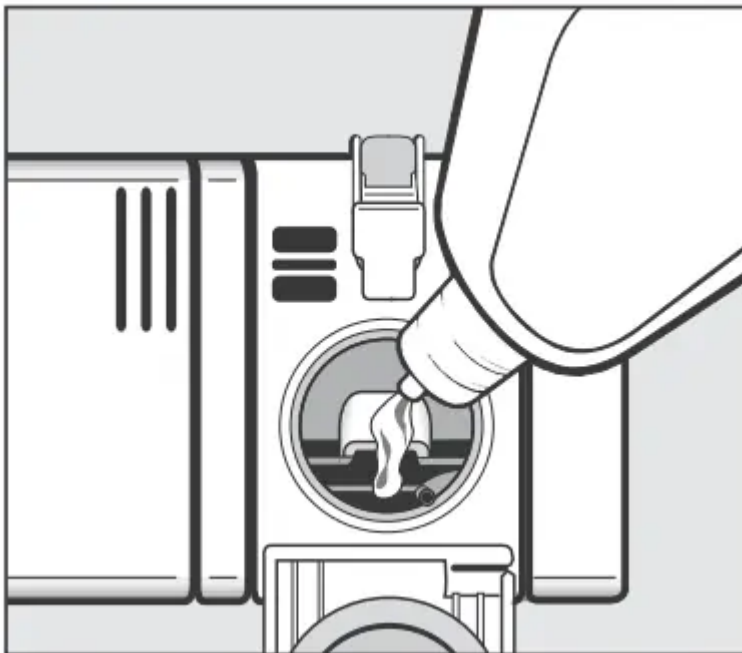

The rinse aid reservoir holds approx. 3.7 oz. (110 ml).

- Close the flap firmly so that it clicks into place. Otherwise water can enter the rinse aid reservoir during a program.
- Wipe up any spilled rinse aid. This prevents over-foaming occurring during the next program.

Rinse aid indicator

When the Rinse aid indicator lights up, the rinse aid reservoir contains sufficient rinse aid for 2 - 3 programs only

- Add rinse aid.

If you consistently use a "Tab" detergent, you can deactivate the refill indicators if you wish (see "Options - Refill indicators").

Setting the rinse aid dosage

You can adjust the rinse aid dosage for best results.





The rinse aid dosage is set in stages from 0 to 6. It is set to 3 at the factory. This is the recommended setting.

The rinse aid dosage can turn out to be higher than the set value due to the automatic adjustment of the program.

If spots appear on dishware and glassware:

- Increase the rinse aid dosage.

If clouding or smearing appears on dishware and glassware:

- Decrease the rinse aid dosage
- Turn the dishwasher off with the  button, if it is turned on.
- Press the program selection button , and, simultaneously switch the dishwasher on using the  button. Keep the program selection button  pressed in for at least four seconds until the lower right program indicator light comes on.

If this does not happen, start the procedure from the beginning again.

- Press the  button three times.

The  indicator light will flash 3 times at short intervals.

The set value will appear in the display after **P**.

The flashing sequence **P 3** will appear in the display.

This indicates a factory default setting of 3.

- Use the program selection button  to select the setting required. Each press of the button moves you up a stage.

The setting is now saved.

- Turn the dishwasher off with the  button.

Tips

Remove coarse food residues from the dishes.

There is no need to rinse items under running water

WARNING: Do not wash items soiled with ash, sand, wax, grease, or paint in the dishwasher. These will damage the dishwasher. Some foods may contain natural dyes, e.g., carrots, tomatoes or tomato sauce. Plastic items in the dishwasher may discolor if large quantities of these foodstuffs find their way into the dishwasher on the dishes. The stability of plastic items is not affected by this discoloration. Cleaning silver cutlery in the dishwasher may also cause plastic items to discolor.

Dishes can be loaded anywhere in the baskets, but the following notes should be observed:

- Do not place dishes or cutlery inside other pieces. They will cover each other.
- Load the dishes so that water can access all surfaces. This ensures that they get properly cleaned.
- Make sure that all items are securely positioned.
- Hollow items such as cups, glasses, pans, etc. must be inverted in the basket.
- Tall, narrow, hollow items, e.g., champagne glasses, should be placed in the center of the basket to ensure better water coverage.
- Concave items such as mugs or bowls should be placed at an angle so that the water can run off.
- The spray arms must not be blocked by items which are too tall or hang through the baskets. If in doubt, test for free movement by manually rotating the spray arms.
- Make sure that small items cannot fall through the holders in the baskets. Small items, e.g., lids, should therefore be placed in the cutlery tray or cutlery basket (depending on model).

Loading the dishwasher

Items not recommended for dishwashing

- Wooden cutlery, cutting boards and dishes or items with wooden parts
- Craft items, antiques, valuable vases, and decorative glassware
- Plastic items which are not heat-resistant: the high temperatures in the dishwasher may cause them to melt or lose shape.
- Copper, brass, tin and aluminum items may discolor or become matt.
- Colors painted over a glaze may fade after a number of washes.
- Delicate glassware and glassware containing lead crystal: clouding may occur over time.

Please note:

Silverware previously cleaned with a **silver polish** may still be damp or spotted at the end of a program, where water has not run off smoothly. It may need to be rubbed dry with a soft cloth.

Silver which has been in contact with foods containing sulphur can discolor. These include egg yolk, onions, mayonnaise, mustard, fish, and marinades.

WARNING: Aluminum components (e.g., range hood grease filters) must not be cleaned with a commercial or industrial cleaning agent. These may damage the material.

Tip: When purchasing new dishes and cutlery, make sure they are dishwasher-safe.

Glass care

- Clouding may occur on glasses after frequent washing. If delicate glassware is washed in the dishwasher, ensure that only very low temperatures are used (see program chart), or a special glass-care program is used (depending on model). This will reduce the risk of clouding.
- Purchase glassware which is dishwasher-safe (e.g., Riedel glassware).
- Use detergents with glass protective additives.

Loading examples

Loading for 10 standard place settings with cutlery tray

Upper basket

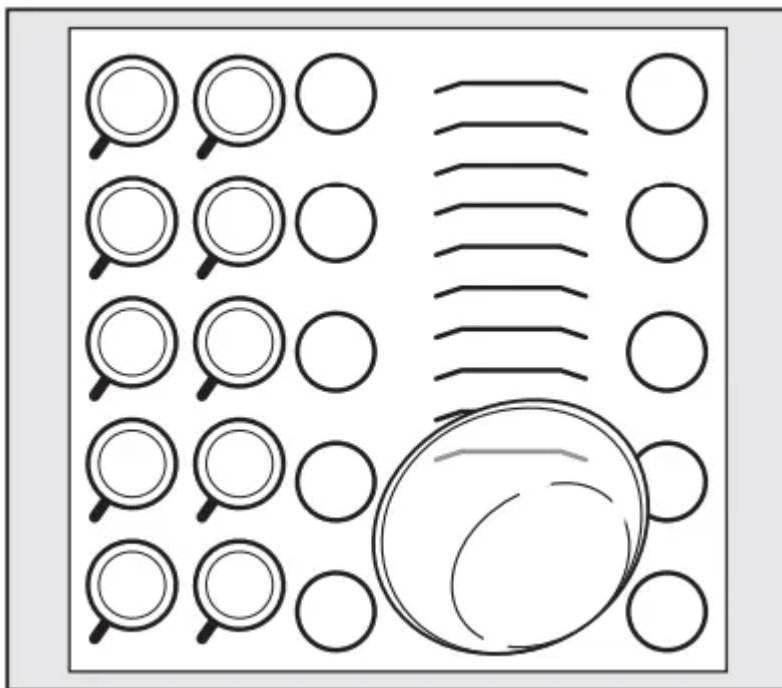

Lower basket

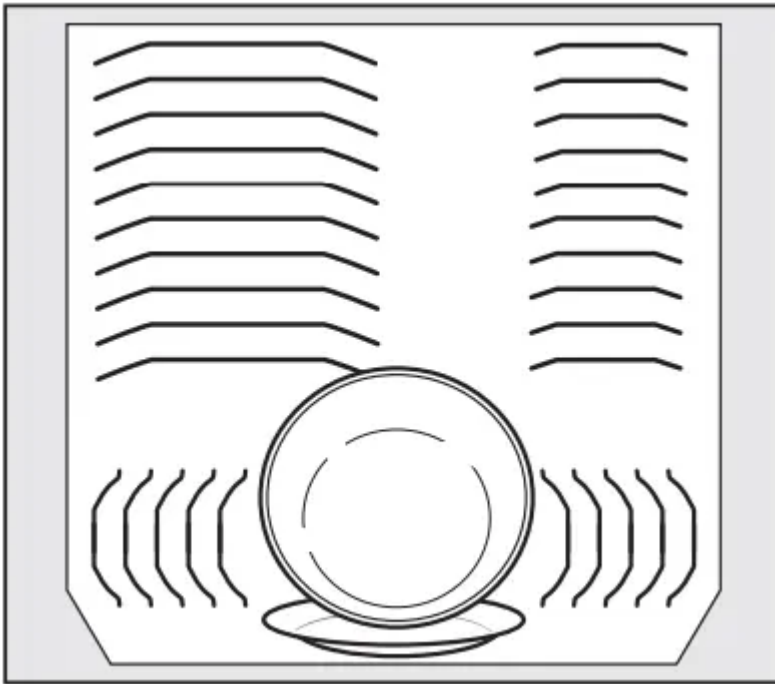

Cutlery tray (depending on model)

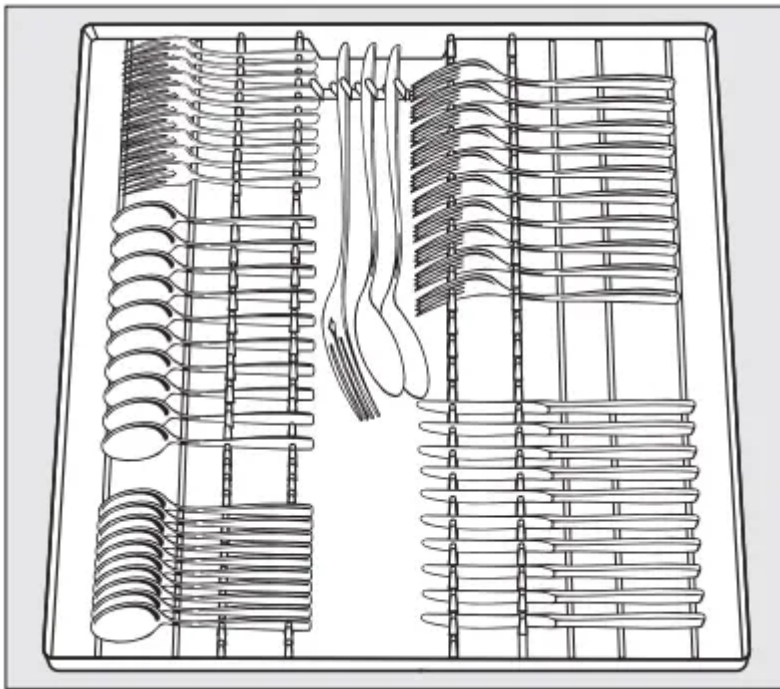

Loading for 16 standard place settings with cutlery tray

Upper basket



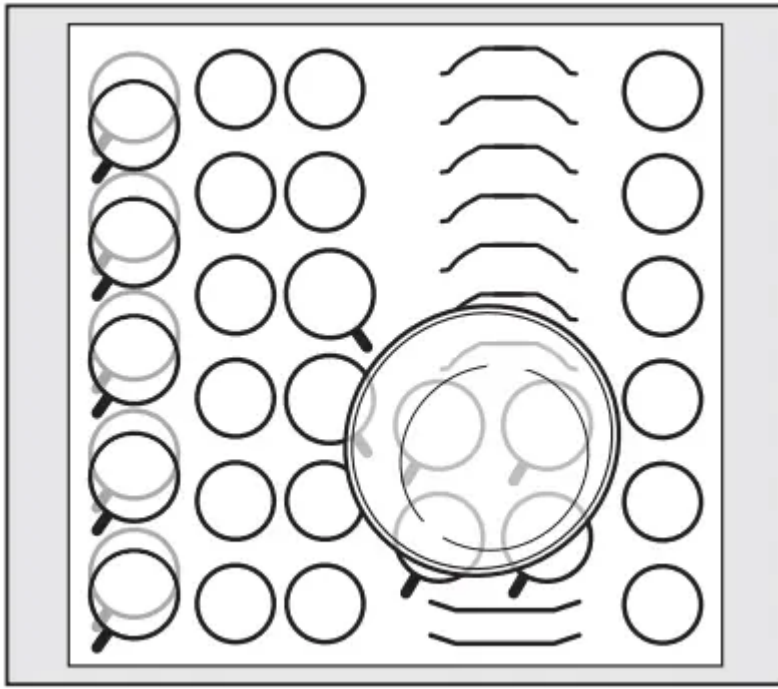

Lower basket

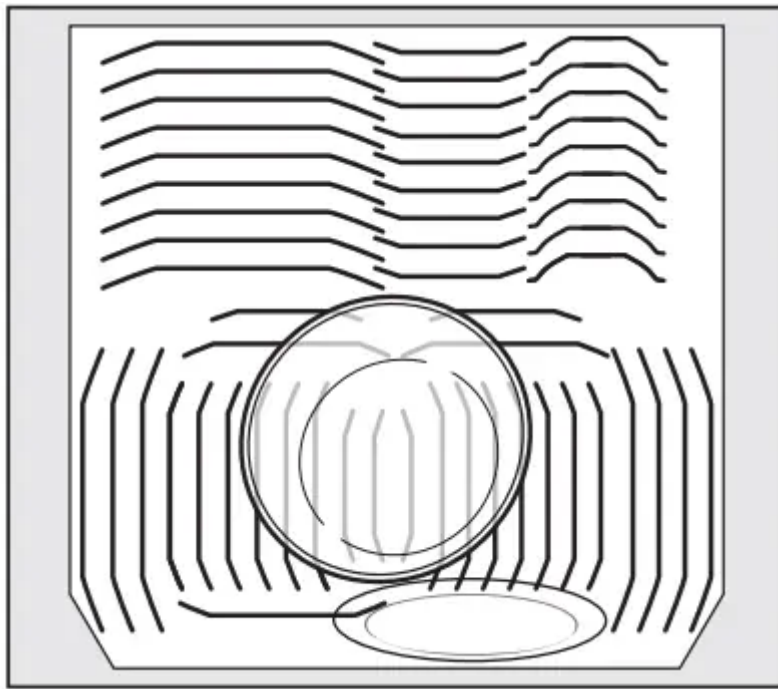

Cutlery tray (depending on model)

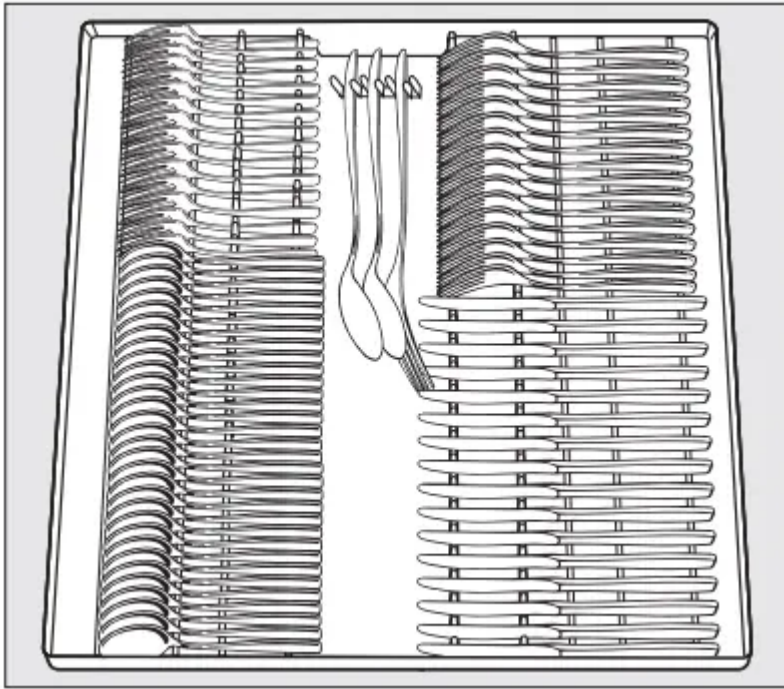

Loading for 10 standard place settings with cutlery basket

Upper basket

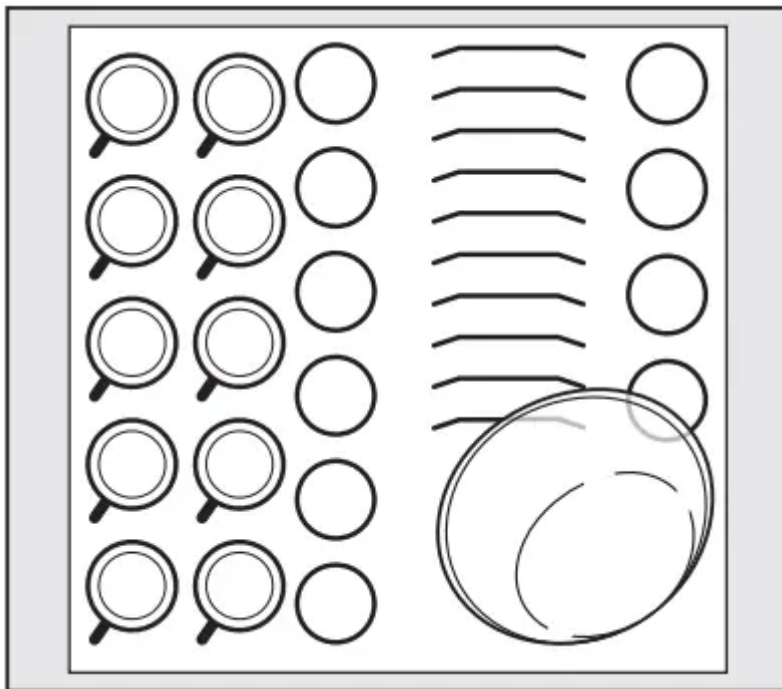

Lower basket





Cutlery basket

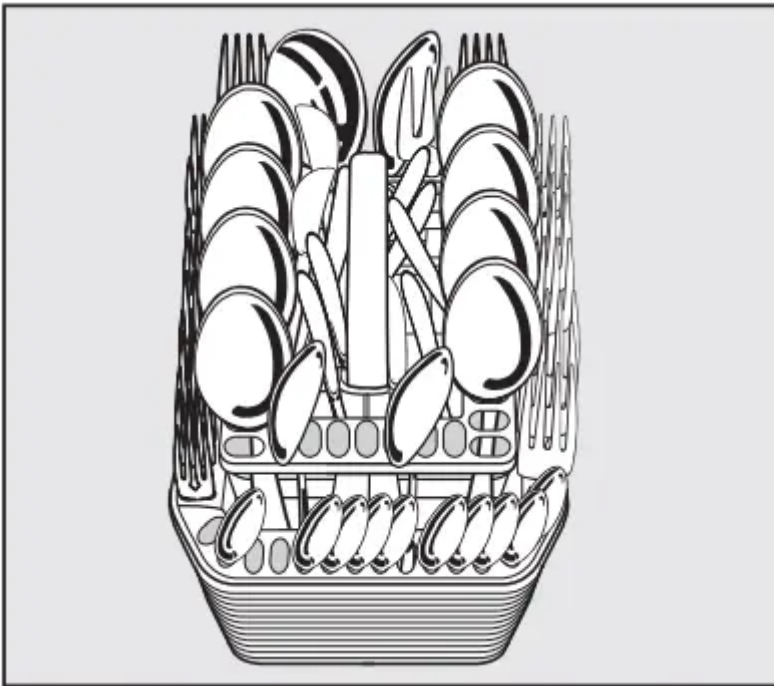

Loading for 13 standard place settings with cutlery basket

Upper basket

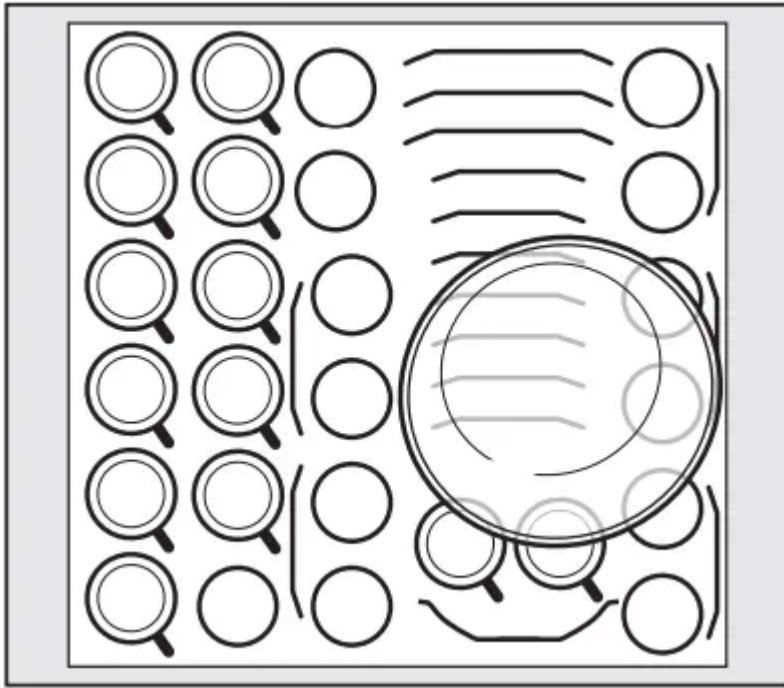

Lower basket



Cutlery basket

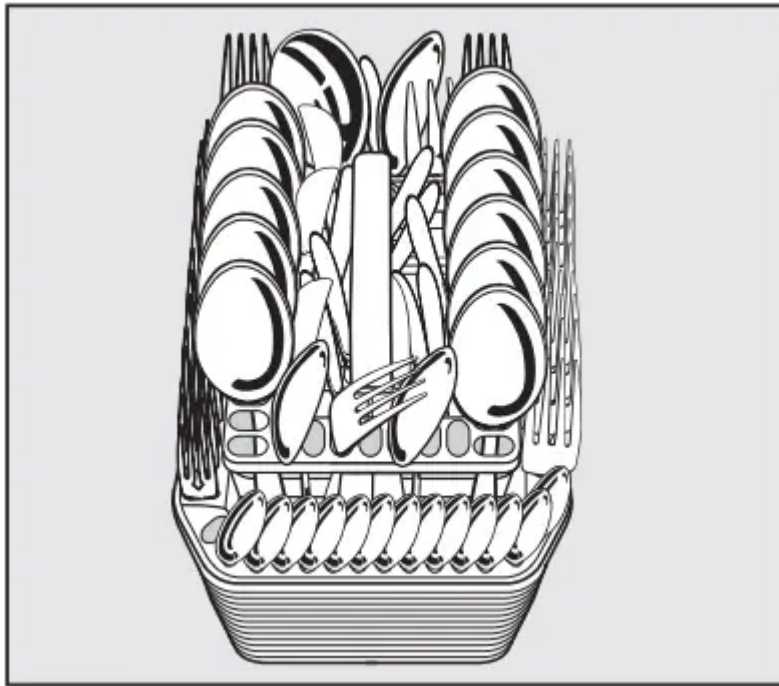

Upper basket

WARNING: For safety reasons, do not operate the dishwasher without the upper and lower baskets in place (except when running the Tall items program, if available).

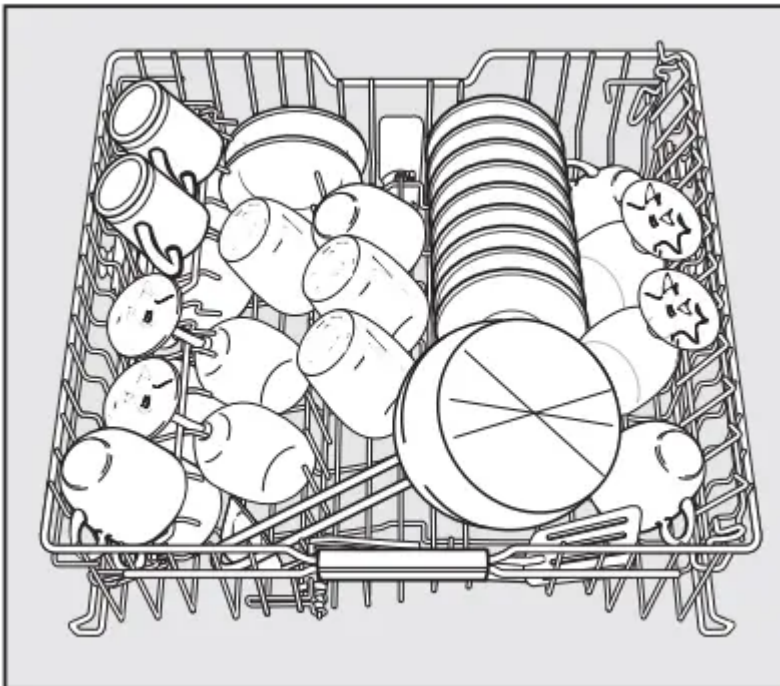

- Use the upper basket for small, lightweight and delicate items such as cups, saucers, glasses, dessert bowls, etc. Shallow pans or casserole dishes can also be placed in the upper basket.
- Long items such as soup ladles, mixing spoons, and long knives should be placed lying down across the front of the upper basket.

Adjustable cup rack (depending on model)

- Raise the rack to make room for tall items.

Glasses can be arranged along the positioning rail of the cup rack to give them some support during the program.

- Lower the cup rack and lean the glasses against it, or double stack smaller pieces.

Adjusting the upper basket

In order to gain more space for taller items the upper basket can be adjusted on three levels with 3/4" (2 cm) between each level.

The upper basket can also be set at an angle with one side high and the other side low. Make sure, however, that the basket can slide smoothly in and out of the cabinet.

Pull the upper basket out.

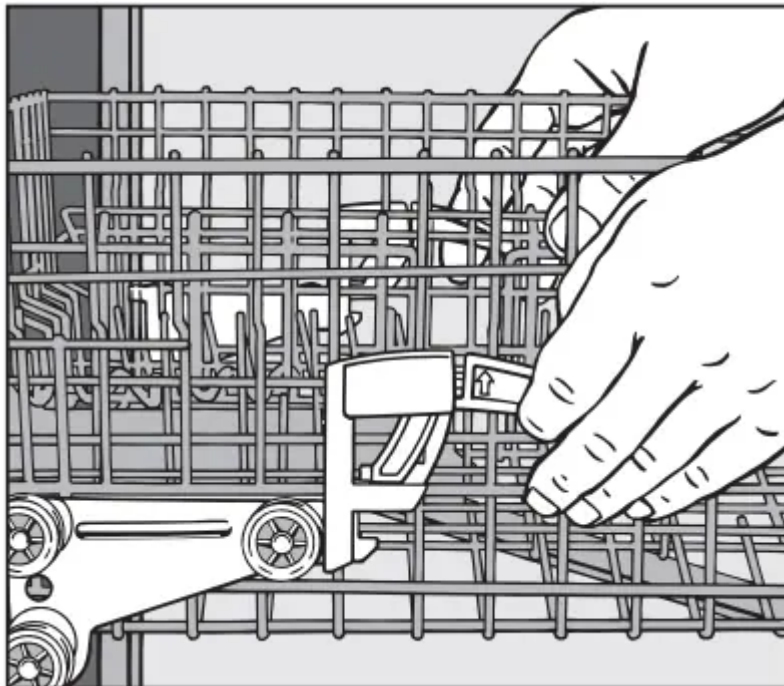

To raise the upper basket:

- Lift the basket until it clicks into place.

To lower the upper basket:

- Pull upwards on the levers at either side of the upper basket.
- Adjust the basket to the desired height and then push the levers securely back down into position.

Depending on the setting of the upper basket, the following plate dimensions can be accommodated.

Dishwashers with cutlery basket

| Upper basket adjustment | Plate \emptyset in inches (cm) | | |
|-------------------------|----------------------------------|--------------|--------------------------------|
| | Upper basket | | Lower basket |
| | ADA | Full-size | |
| Upper | 7 7/8" (20) | 9 7/16" (24) | 12 3/16" (31) 13 3/4" (35*) |
| Middle | 8 11/16" (22) | 10 1/4" (26) | 11 7/16" (29) |
| Lower | 9 7/16" (24) | 11" (28) | 10 5/8" (27) |

Dishwashers with cutlery tray

| Upper basket adjustment | Plate \emptyset in inches (cm) | | |
|-------------------------|----------------------------------|--------------|--------------------------------|
| | Upper basket | | Lower basket |
| | ADA | Full-size | |
| Upper | 7 7/8" (15) | 7 1/2" (19) | 12 3/16" (31) 13 3/4" (35*) |
| Middle | 6 11/16" (17) | 8 1/4" (21) | 11 7/16" (29) |
| Lower | 7 1/2" (19) | 9 1/16" (23) | 10 5/8" (27) |

* When tilted, plates of up to 13 3/4" (35 cm) can be accommodated.

Depending on the setting of the upper basket, a variety of plate dimensions can be accommodated.

Lower basket

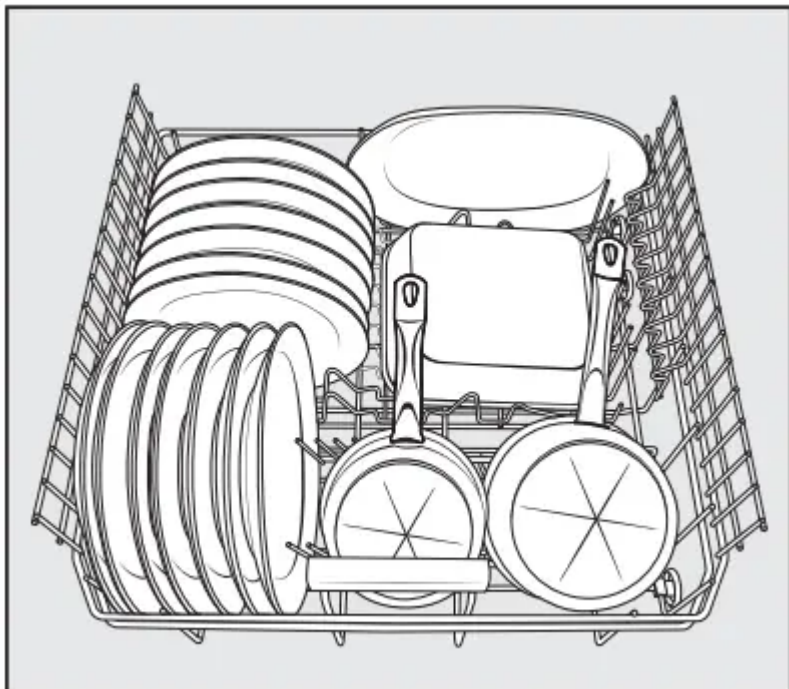

- For larger and heavier items such as plates, serving platters, saucepans, bowls, etc.

Glasses, cups and small items such as saucers can also be placed in the lower basket. Do not place thin, delicate glassware in the lower basket.

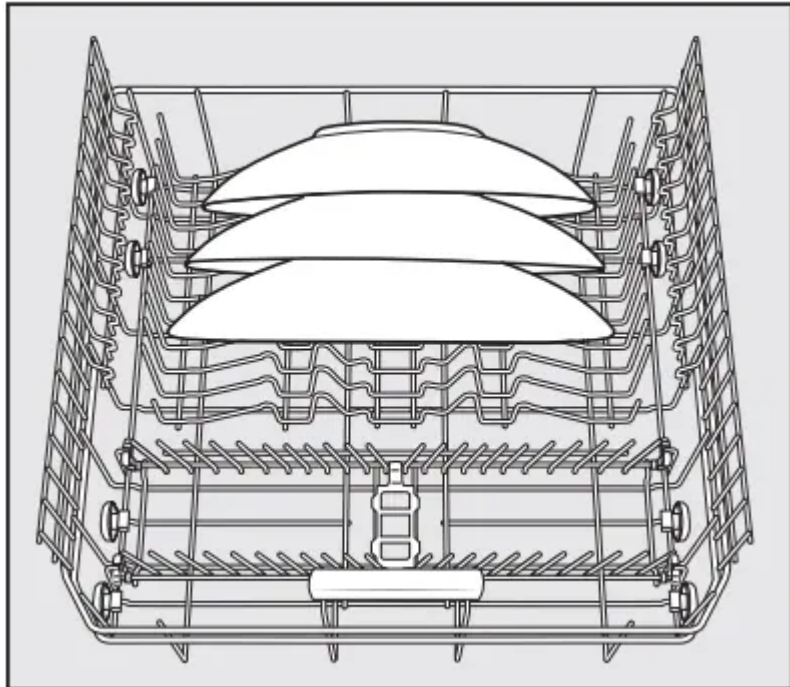

- Place large platters and dishes in the center of the lower basket.

When tilted, plates up to 13 3/4" (35 cm) in diameter can be accommodated.

MultiComfort area

The rear section of the lower basket is used for washing cups, glasses, plates, pots and pans.

Hinged spikes

The spikes at the front are used for washing plates, soup bowls, platters, dessert bowls, and saucers.

The spikes can be lowered to make more room for large items, e.g. pots, pans, and bowls.

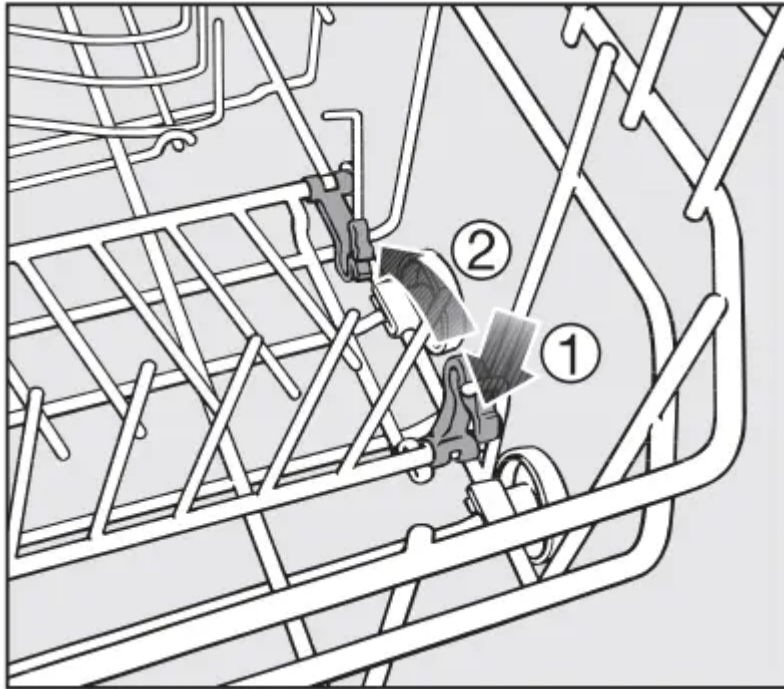

- Press the yellow lever downwards (1), and then lower the spikes (2).

Cutlery

3D cutlery tray (depending on model)

- Arrange the cutlery in the tray as shown.

To make unloading much easier, cutlery should be grouped in zones, one for knives, one for forks, one for spoons, etc.

Spoon heads should be placed in contact with at least one of the serrated retainers on the base of the cutlery tray to ensure that water runs off them freely.

The upper spray arm must not be blocked by items which are too big.

The side sections of the tray can be moved into the middle to accommodate tall items of dishware in the upper basket.

If spoon handles do not fit between the holders, lay them the other way round.

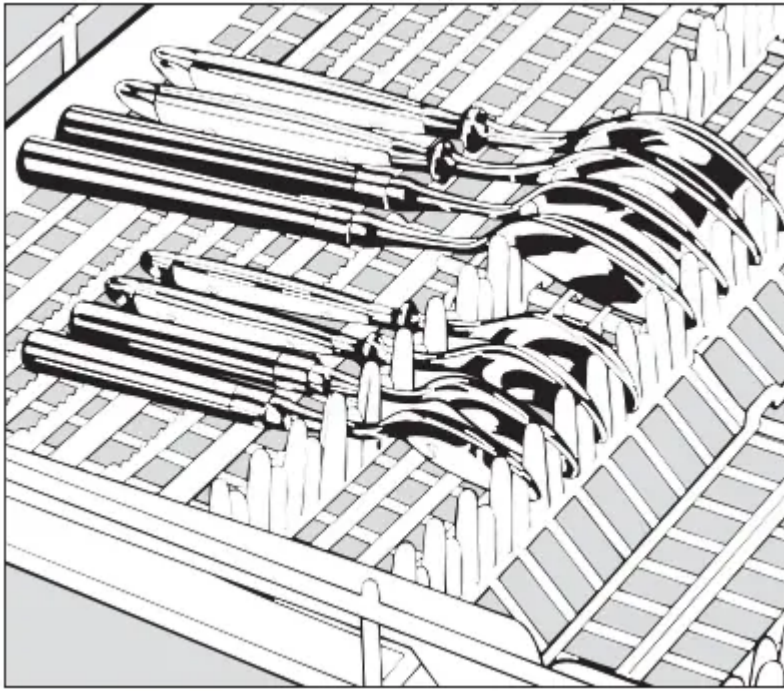

You can use the yellow slide to adjust the height of the middle section of the cutlery tray to make more room for large items of cutlery, such as serving spoons and ladles.

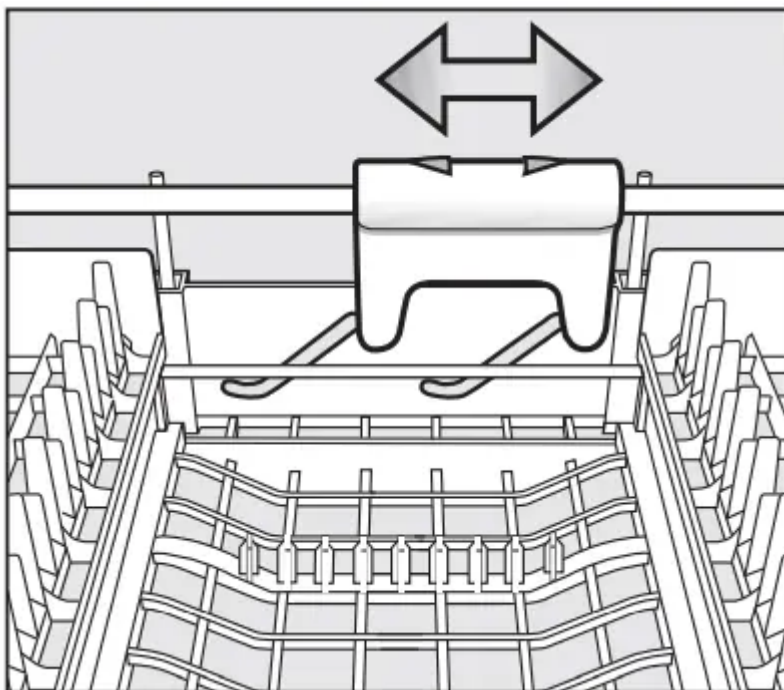

Cutlery basket (depending on model)

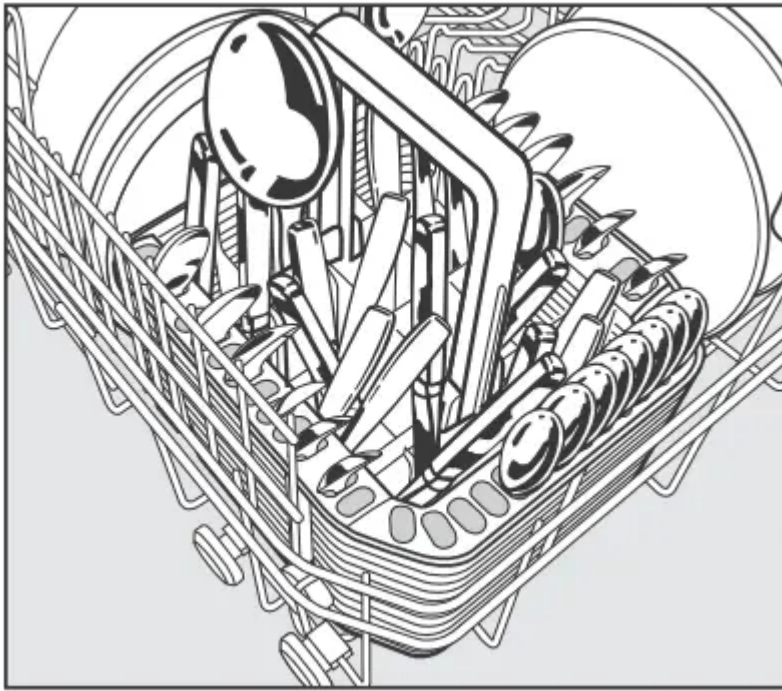

The cutlery basket can be placed anywhere on the front rows of spikes in the lower basket.

- To avoid the risk of injury, knives and forks should be placed with the handles upwards in the basket. However, cutlery placed handle down in the basket will come out cleaner and drier.
- Place small items of cutlery in the individual slots on three sides of the cutlery basket.

Cutlery insert for the cutlery basket

Use the insert supplied for heavily soiled items of cutlery. The insert separates the items so that they can be more easily accessed by water.

- Fit it onto the cutlery basket if required.

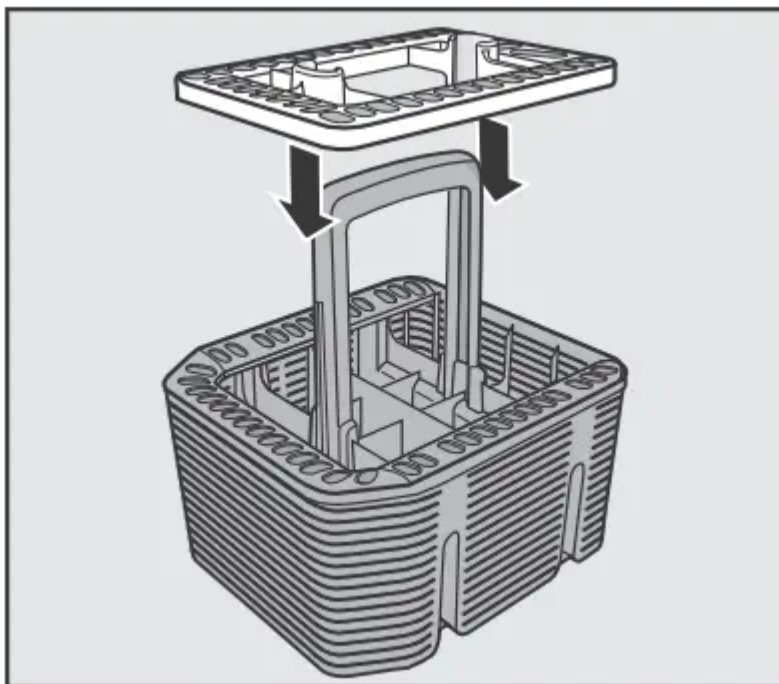

- Insert cutlery with the handles facing downwards.
- Distribute them evenly along the insert.

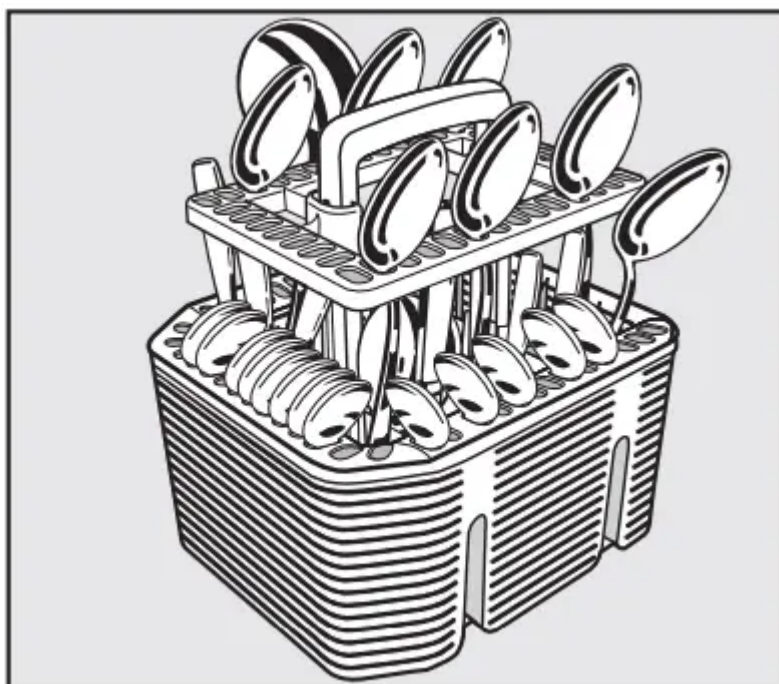

Operation

Detergent

WARNING: Only use detergents formulated for domestic dishwashers.

Refer to the manufacturer's packaging as to whether Tab products are suitable for the water hardness level in your area.

Please note that the cleaning and drying results of Tab detergents can vary greatly.

For optimum cleaning and drying results, use Miele dishwasher detergent and add Miele salt and Miele rinse aid separately.

Detergent dosage

- Follow the dosage recommended by the manufacturer on the packaging.
- Unless directed otherwise, use one detergent tab or add 1 1/4 - 2 tablespoons (20 - 30 ml) detergent to compartment II, depending on the level of soiling. With very heavy soiling you can also add a small amount of detergent to compartment I.
- Tabs may not dissolve completely when the Express program (if available) is used.

Use only the recommended amount of detergent. Continued use of too much detergent may cause machine damage.

WARNING: Dishwasher detergents can cause burning in the nose, mouth, and throat if swallowed, or inhibit breathing.

Avoid inhaling or swallowing dishwasher detergent. Keep children away from detergent. Keep detergent out of the reach of children. Keep children away from the dishwasher when the door is open. There could still be detergent residues in the dishwasher. Only add detergent just before starting the program and lock the door with the child safety lock (depending on model).

Adding detergent

Press the opening catch on the detergent dispenser. The flap will spring open.

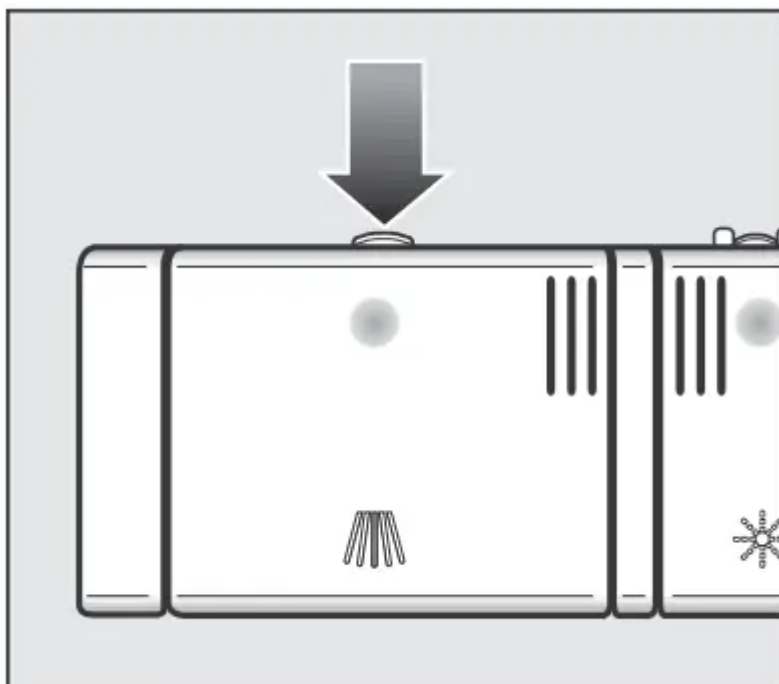

The flap is always open at the end of a program.

Add the required amount of detergent and close the flap.

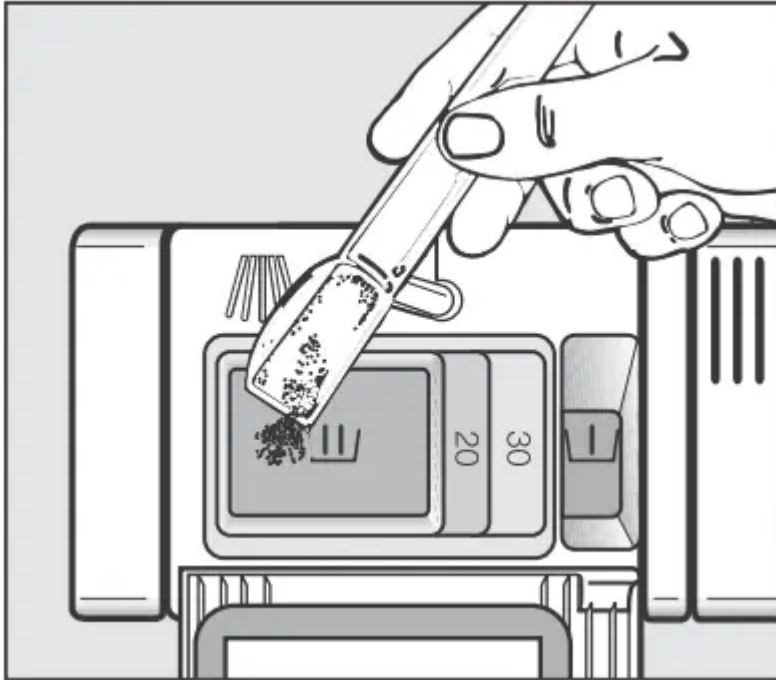

Make sure that the detergent packaging is properly closed after use to avoid it getting damp and becoming lumpy.

Dispensing aid

Compartment I holds a maximum of 2 teaspoons (10 ml), Compartment II holds a maximum of 3 ½ tablespoons (50 ml) of detergent.

The marks in compartment II indicate the levels of approximately 1 ¼ and 2 tablespoons (20 and 30 ml) respectively. The marks indicate the approximate fill level in ml when the door is open in a horizontal position.

Turning on

- Turn on the water supply if it is turned off.
- Open the door.
- Make sure the spray arms are not obstructed.
- Turn the dishwasher on with the  button.

The indicator light next to the program selected will come on.

Selecting a program

Choose your program according to the type of load and the degree of soiling.

The different programs and their uses are described in the Program Overview chapter.

Use the program selection button  to select the program required.

The indicator light for the program selected will light up.

The program duration will appear in hours and minutes in the display.

You can now select program options (see “Options”).

If any program options are selected, the appropriate indicator lights will also light up.

Starting a program

Start the program by closing the door within four seconds of the last press of a button.

The program will begin.

If you do not close the door within four seconds, the indicator lights of the selected program and the time display will flash.

The program cannot be started until you press the program selection button and close the door within four seconds.

A program should only be canceled in the first few minutes, if at all. Otherwise important program stages could be omitted.

Time display

The duration of the program selected appears in hours and minutes in the display before the program begins. During the program, the time left until the end of the program can only be viewed when the door is open.

The program duration displayed may vary with the same program. It is influenced by, among other things, the water temperature at each intake, the reactivation process, the softener assembly, the type of detergent, the amount of dishes, and the amount of soiling.

When a program is selected for the first time, the display will show the average program duration for a cold water intake.

The times shown in the program overview refer to standard test loads and temperatures.

Each time a program is run, the electronic module calculates the program duration required depending on the temperature of the water taken into the dishwasher and the amount of dishes.

Energy management

To save energy, the dishwasher will switch off automatically 10 minutes after the last time a button has been pressed or 10 minutes after the end of the program.

Press the  button to switch the dishwasher back on.

The dishwasher will not turn off while a program is running, during the delay start period, or if there is a fault.

At the end of the program

A buzzer will sound at the end of the program with the door closed.

Open the door.

0.00 will appear in the time display.

If the program indicator light is still flashing, the program is not yet finished. Close the door again so that the program can continue until it has finished.

The drying fan may continue to run for a few minutes at the end of the program.

You can now empty the dishwasher.

WARNING: To prevent the risk of steam damage to the counter edging above the dishwasher, it is advisable to leave the door closed until you are ready to unload the dishware. Alternatively you can open the door fully until the dishware is cool enough to unload. Do not leave the door only partially open.

Turning off the dishwasher

At the end of a program:

- Open the door.
- The dishwasher can be switched off at any time using the  button.

Switching the dishwasher off during a program stops the program.

Turning the dishwasher off during the delay start time will also stop the process.

If the dishwasher is not going to be used for a longer period of time, e.g., while on vacation, the water supply should be turned off.

Unloading the dishwasher

Dishes tend to break and chip more easily when they are hot. Allow the dishes to cool until they are comfortable enough to handle before unloading them.

The dishes will cool much faster if you open the door when the program has ended.

First unload the lower basket, then the upper basket, and finally the cutlery tray (depending on model). This will prevent water drops from the upper basket and cutlery tray from falling onto the dishes in the lower basket.

Interrupting a program

A program will be interrupted as soon as the door is opened.

Close the door and press the Start button.



The program will continue from the point at which it was interrupted.

WARNING: Water in the dishwasher may be hot. Danger of scalding! Only open the door if absolutely necessary and exercise extreme caution when doing so. Before closing the door again, leave it ajar for approx. 20 seconds. This will enable the temperature in the wash cabinet to settle. After that, close the door and press the Start button.

Changing a program

If the detergent dispenser flap has already opened, do not change the program.

If a program has already started and you wish to change it, proceed as follows:



- Open the door.
- Turn the dishwasher off with the  button.
- Turn the dishwasher on again with the  button.
- Select the desired program.
- Start the program by closing the door within four seconds.

Options

Short

The Short  option reduces the duration of programs in which this option is available.

In order to achieve optimum cleaning results, consumption rates are increased with this option.



- Open the door.
- Turn the dishwasher on with the  button.
- Select a program.
- Press the  button. The  indicator light will light up.
- The program can now be started.

The option selected will remain active for that particular program until the setting is changed.

Turning off the refill indicator

If you consistently use a Tab detergent, you can deactivate the refill indicator if you wish.

- Open the door.
- Turn the dishwasher off with the  button, if it is turned on.

- Press the program selection button , and, simultaneously switch the dishwasher on using the  button. Keep the program selection button  pressed in for at least four seconds until the lower right program indicator light comes on.

If this does not happen, start the procedure from the beginning again.

- Press the  button 9 times.

The  indicator light will flash 9 times at short intervals.

The flashing sequence in the time display will indicate whether the refill indicator is switched on or off.

– **P1**: Refill indicator is turned on.

– **P0**: Refill indicator is turned off.

- Press the program selection button  to change the setting.

The setting is now stored in memory.

- Turn the dishwasher off with the  button.



If you switch to using detergent that does not contain salt or rinse aid, it is important to remember to add dishwasher salt and rinse aid and to turn the indicators back on.

Delay Start

You can set the start time for a program, e.g., to take advantage of night time electricity rates. The start time can be delayed between 30 minutes and 24 hours.



The delay period is shown in 30 minutes increments for a delay period between 30 minutes and 9 hours 30 minutes. It is shown in hours for periods longer than this.

When using the Delay Start function, make sure that the detergent compartment is dry before adding detergent. Wipe dry with a cloth if necessary. If the compartment is wet, powder detergent can become lumpy and stick to the dispenser, with the result that it is not fully dispensed. Do not use liquid detergent when selecting Delay Start, as it can run into the dishwasher before it is required.

- Open the door.
- Turn the dishwasher on with the  button.
- Select the desired program.
- Press the  button.

The last delay start time used will appear in the time display. The  indicator light will light up.

- Set the required delay start time using the  button.

If you keep the  button pressed, the time will increase automatically up to **24** hours. To get back to **0.30** hours, press the  button twice.

- Close the door.
- Open the door if you need to check how long the delay period has left to run.

The time up until the program starts will count down in the display in hours for durations above 10 hours, and in minutes for durations below 10 hours.

When the set time is reached, the program selected will start automatically. The time remaining will appear in the time display and the  indicator light will go out.

How the Delay Start time is shown in the display:



up to 59 minutes: e.g., 30 minutes = **0.30**

1 hour up to 9 hours 30 minutes: e.g., 5 hours = **5.00**

over 10 hours: e.g., 15 hours = **15**

Starting a program before the delay start time has elapsed:

A program can be started before the delay start period has elapsed. Proceed as follows:

- Open the door.
- Turn the dishwasher off with the  button.
- Turn the dishwasher on again with the  button.
- Select the program you want.
- Start the program by closing the door.

Buzzer tones





A sequence of audible tones will sound at the end of the program or if there is a fault.

The buzzer at the end of a program and the warning buzzer in the event of a fault will sound 4 times at intervals with a short pause between each set.

The buzzer tones are activated at the factory.

You can deactivate the buzzer that sounds at the end of a program if you wish. The warning buzzer for faults cannot be deactivated.

- Open the door.

- Turn the dishwasher off with the  button, if it is turned on.
- Press the program selection button , and, simultaneously switch the dishwasher on using the  button. Keep the program selection button  pressed in for at least four seconds until the lower right program indicator light comes on.

If this does not happen, start the procedure from the beginning again.

- Press the  button 4 times.

The  indicator light will flash 4 times at short intervals.

The flashing sequence in the time display shows whether the buzzers at the end of the program are activated or deactivated.

– *P1*: Buzzer tones activated

– *P0*: Buzzer tones deactivated

- Press the program selection button  to change the setting.

The setting is now stored in memory.

- Turn the dishwasher off with the  button.





Optimize Standby

“Optimize Standby” is activated by default.

To save energy, the dishwasher will switch off automatically a few minutes after the last time a button has been pressed or after the end of a program.

The dishwasher will not turn off while a program is running, during the delay start period, or if there is a fault.

Optimize Standby can be switched off if you prefer. If you do this the duration before the dishwasher switches off automatically increases to 6 hours. Doing this will increase energy consumption.

- Open the door.
- Turn the dishwasher off with the  button, if it is turned on.
- Press the program selection button , and, simultaneously switch the dishwasher on using the  button. Keep the program selection button  pressed in for at least four seconds until the lower right program indicator light comes on.

If this does not happen, start the procedure from the beginning again.

- Press the  button 8 times.

The  indicator light will flash 8 times at short intervals.

The flashing sequence in the time display shows whether or not Optimize Standby is activated.

– **P1**: “Optimize Standby” activated

– **PD**: “Optimize Standby” deactivated





- Press the program selection button  to change the setting.

The setting is now stored in memory.

- Turn the dishwasher off with the  button.

Factory default settings

If you have altered any settings from the factory default, you can reset them back to the factory default settings as follows:

- Open the door.
- Turn the dishwasher off with the  button, if it is turned on.
- Press the program selection button , and, simultaneously switch the dishwasher on using the  button. Keep the program selection button  pressed in for at least four seconds until the lower right program indicator light comes on.

If this does not happen, start the procedure from the beginning again.

- Press the  button 19 times.

The  indicator light will flash once at a long interval and then 9 times at short intervals.

The flashing sequence in the display indicates whether a setting has been changed from its factory default.

– **P1**: All settings are set to factory default settings

– **PD**: At least one setting has been changed

- To reset the dishwasher to the factory default settings, press the program selection button .

The setting is now stored in memory

- Turn the dishwasher off with the  button.

Cleaning and care

Check and clean your dishwasher regularly. This will help avoid problems and faults.

WARNING: All surfaces are susceptible to scratching. Contact with unsuitable cleaning agents can alter or discolor all surfaces.

Cleaning the wash cabinet

Generally, the wash cabinet is self cleaning if the correct amount of detergent is used.

If, however, there are limescale or grease deposits in the wash cabinet, these can be removed with a special cleaning agent (available from Miele). Follow the instructions on the packaging.

If you mainly use low temperature programs (< 120°F/50 °C), there is a risk of bacteria and unpleasant odors building up in the wash cabinet. To prevent this happening the dishwasher will automatically increase the temperature in the final rinse of the selected program after several programs using low temperatures have been run.

- Clean the filters in the wash cabinet regularly.

Cleaning the door and the door seal

Bacteria could build up on the door seal and the sides of the dishwasher door as these surfaces are outside the wash cabinet and are not accessed and cleaned by the spray arm jets.

- Wipe the door seals regularly with a damp cloth to remove food deposits.
- Wipe off any food or drink residues which may have dripped onto the sides of the dishwasher door before closing it.

Cleaning the control panel

- The control panel should only be wiped with a damp cloth.

Cleaning the door front

WARNING: If soiling remains longer, it may happen that the surfaces can become discolored or changed. Remove any soiling immediately.

- Clean the front with a solution of warm water and a little dishwashing liquid applied with a soft sponge. Wipe the surfaces dry using a soft cloth.
- **WARNING:** Glass cleaners may be used to clean the exterior. However do not allow them to sit or “puddle”, this can cause damage to the surface. Remove the cleaner promptly.

To better maintain your appliance avoid the following:

- Cleaning products containing soda, ammonia, acid, or chloride

- Descaling agents
- Abrasive cleaning products, such as scouring powder, scouring liquid, or pumice stones,
- Cleaners containing solvents
- Stainless steel cleaners
- Dishwasher cleaner
- Oven cleaners
- Glass cleaner
- Hard, abrasive brushes or sponges, e.g., pot scourers, brushes or sponges which have been previously used with abrasive cleaning agents
- Eraser sponges
- Sharp metal scrapers
- Steel wool
- Steam cleaning appliances

Filter system

The filter system in the base of the wash cabinet prevents food from being redeposited on dishes. It also protects the circulation pump from damage caused by foreign objects.

WARNING: This dishwasher must not be used without all the filters in place!

Collection of coarse soil may cause the filters to clog. The level of soiling and time it takes before the filters need cleaning will vary depending on use.

- Check the condition of the filters regularly and clean them if necessary.
- Turn the dishwasher off.

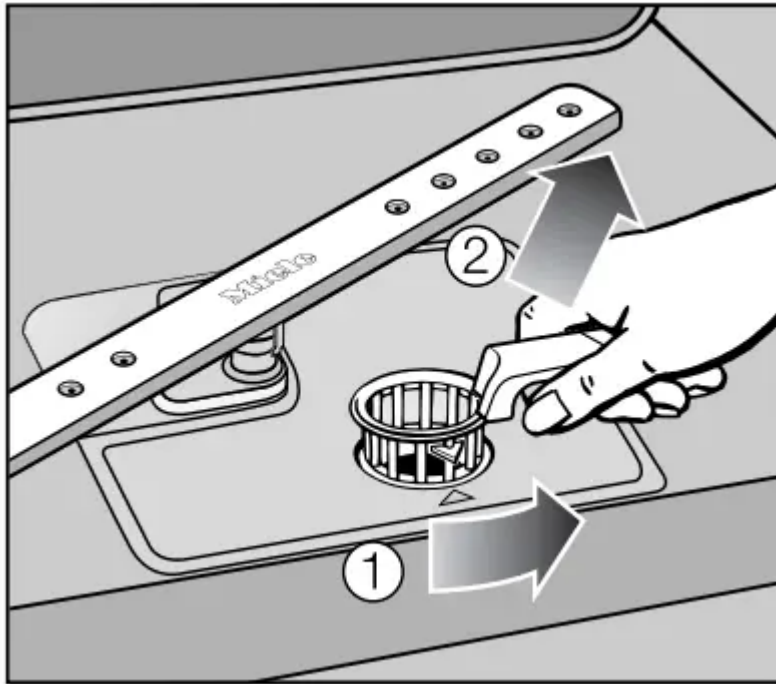

- Turn the handle counter-clockwise to release the filter system (1).
- Lift the filter system out of the dishwasher (2). Remove any coarse particles and rinse the filter well under running water. Use a nylon brush if necessary.

WARNING: Ensure that coarse soil does not get into the circulation system and cause a blockage.

To clean the inside of the filter, the flap must be opened:

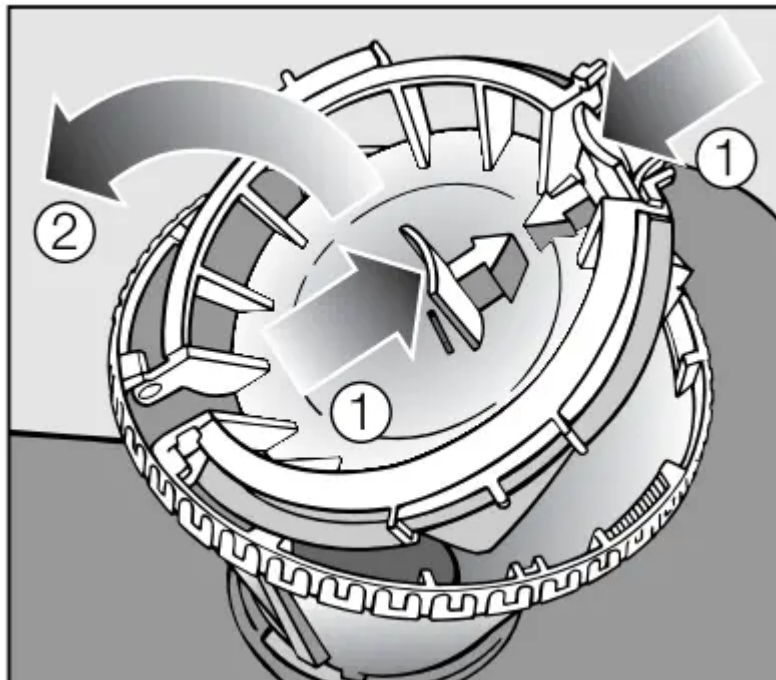

- Press catches (1) together in the direction of the arrows as shown, and open the filter (2).
- Rinse all the filters under running water.

- Then close the flap so that the catch engages.
- Replace the filter system so that it lies flat in the base of the wash cabinet.
- Then turn the handle clockwise until both arrows point towards each other. This will lock the filter system in place.

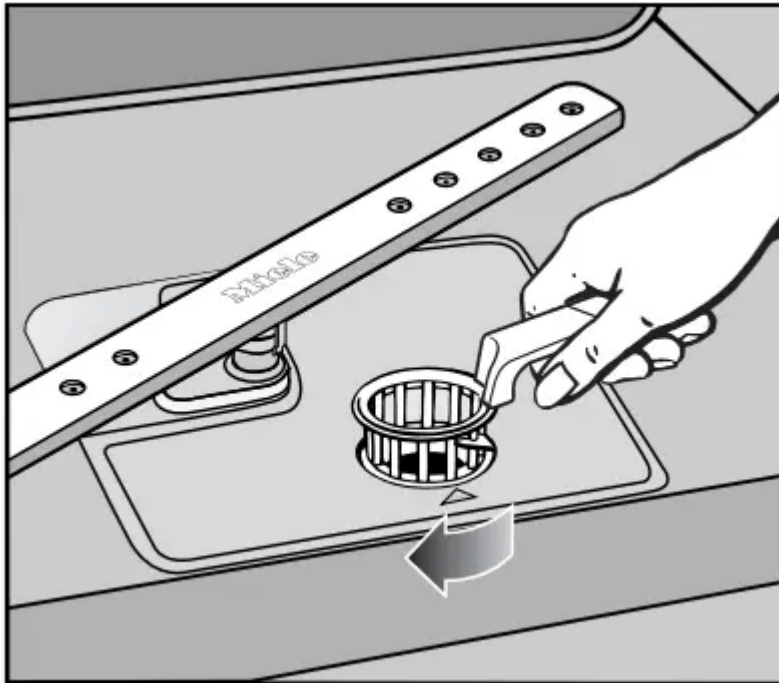

WARNING: Take care when you are fitting the filter system that it is secured in position correctly. Otherwise coarse soil could get into the circulation system and cause a blockage.

Cleaning the spray arms

Particles of food can get stuck in the spray arm jets and bearings. The spray arms should therefore be inspected and cleaned regularly (approx. every 4 - 6 months).

- Turn the dishwasher off.

Remove the spray arms as follows:

- Take out the cutlery tray (if your dishwasher is fitted with one).
- Push the top spray arm upwards to engage the inner ratchet. Then unscrew the spray arm.

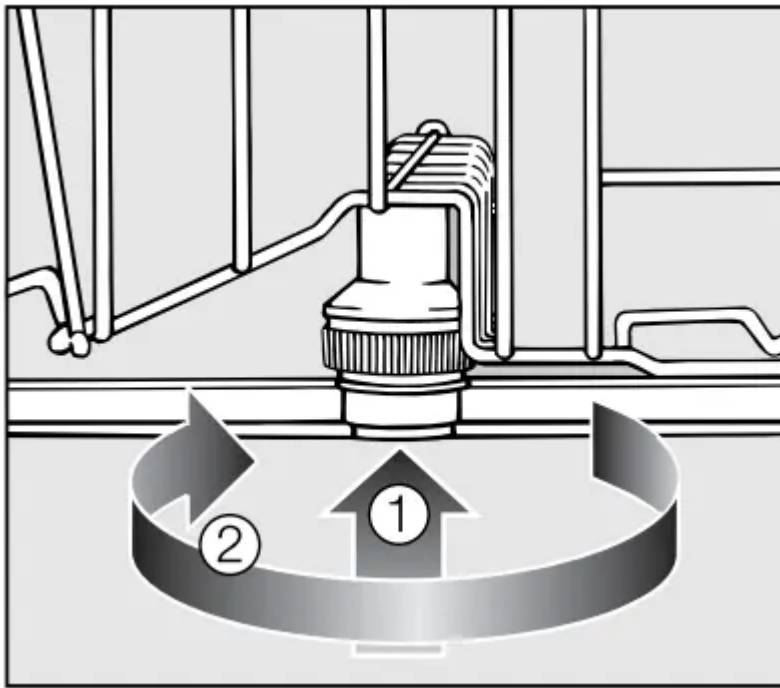

- Push the middle spray arm upwards (1) to engage the ratchet. Then unscrew the spray arm (2).
- Remove the lower basket
- Pull the lower spray arm firmly upwards to remove it.

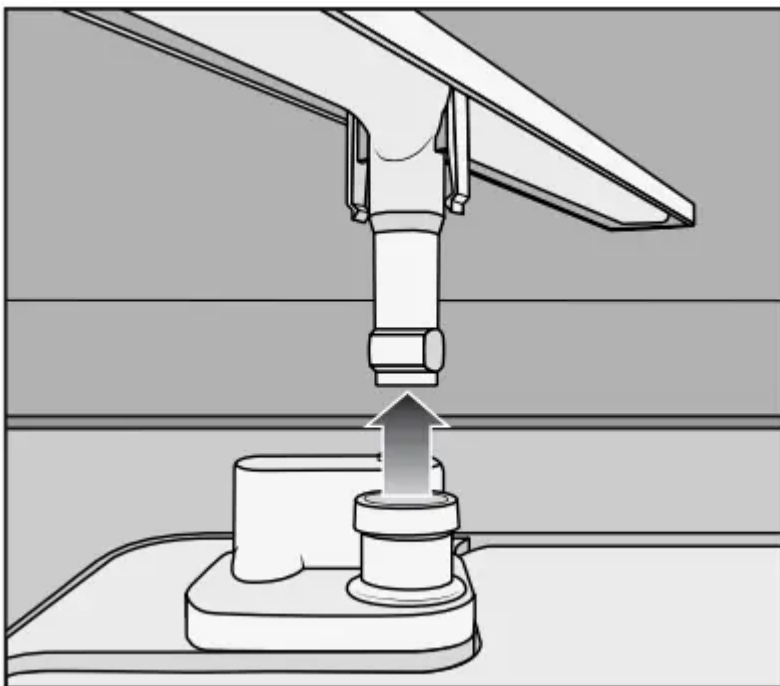

- Use a pointed object to push the food particles that are stuck in the spray arm jets into the spray arm.

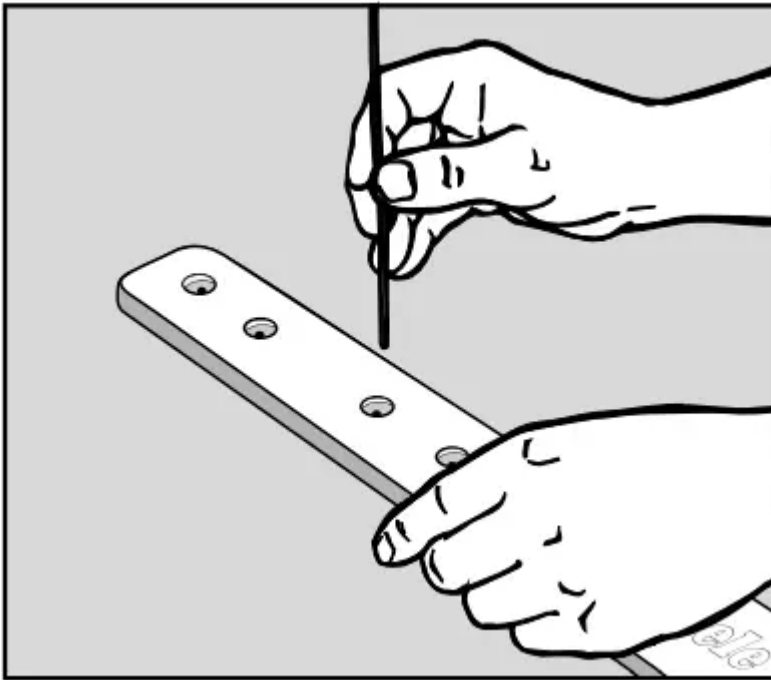





- Rinse the spray arms thoroughly under running water.
- Replace the spray arms and check that they rotate freely.

Frequently Asked Questions

Technical problems



| Problem | Possible cause and solution |
|--|--|
| <p>The dishwasher does not start.</p> | <p>The door is not properly closed.</p> <ul style="list-style-type: none"> - Push the door firmly shut. |
| | <p>The dishwasher is not plugged in.</p> <ul style="list-style-type: none"> - Insert the plug. |
| | <p>The circuit breaker has tripped.</p> <ul style="list-style-type: none"> - Reset the fuse (see data plate for the correct fuse rating). |
| | <p>The dishwasher is not switched on.</p> <ul style="list-style-type: none"> - Turn the dishwasher on with the  button. |
| <p>The dishwasher stops during a program.</p> | <p>The circuit breaker has tripped.</p> <ul style="list-style-type: none"> - Reset the fuse (see data plate for the correct fuse rating). - If the circuit breaker trips again, contact Miele Service. |
| <p>The warning buzzer is sounding. All the program indicator lights flash when the door is opened. Fault code FXX appears in the time display</p> | <p>There may be a technical fault.</p> <ul style="list-style-type: none"> - Turn the dishwasher off with the  button. - Turn the dishwasher back on after a few seconds. - Select the desired program. - Close the door. <p>If the indicator lights flash again, there is a technical fault.</p> <ul style="list-style-type: none"> - Contact Miele Service. |
| <p>Fault F70: The drain pump is still running, even with the door open.</p> | <p>The WaterProof System has reacted.</p> <ul style="list-style-type: none"> - Turn off the water supply. - Contact Miele Service. |
| <p>Fault F78:</p> | <p>A fault has occurred in the circulation pump.</p> <ul style="list-style-type: none"> - Turn the dishwasher off for at least 30 seconds with the  button. |

| | |
|--|--|
| | <ul style="list-style-type: none"> - Turn the dishwasher back on. - Select the desired program. - Close the door. <p>If the fault message appears again, there is a technical fault.</p> <ul style="list-style-type: none"> - Contact Miele Service. |
| <p>The dishwasher stopped working shortly after the program started. The warning buzzer is sounding. The Intake/Drain indicator light is flashing on and off.</p> | <p>The water supply is turned off.</p> <ul style="list-style-type: none"> - Turn on the water supply all the way |
| <p>The dishwasher stops during a program. The warning buzzer is sounding. The Intake/Drain indicator light flashes. Fault code F12 or F13 appears in the time display.</p> | <p>Before fixing the fault:</p> <ul style="list-style-type: none"> - Turn the dishwasher off with the  button. <hr/> <p>There is a problem with the water intake.</p> <ul style="list-style-type: none"> - Turn on the water supply fully and start the program again. - Clean the water intake filter. - The flow pressure at the connection point is lower than 7.25 psi. <p>Contact a plumber</p> |

Water drainage fault

| Problem | Possible cause and solution |
|---|---|
| <p>The dishwasher stops during a program. The warning buzzer is sounding. The Intake/Drain indicator light flashes. Fault code F11 appears in the time display</p> | <p>Before fixing the fault:</p> <ul style="list-style-type: none"> - Turn the dishwasher off with the  button. <p>There is a problem with the water intake. There might be water in the wash cabinet.</p> <ul style="list-style-type: none"> - Clean the filter system - Clean the drain pump - Clean the non-return valve - Remove any kink or loop in the drain hose. |
| <p>The warning buzzer is sounding. The indicator light of the selected program and the time display flash. The dishwasher does not start or the delay start time stops running.</p> | <p>The safe mode of the dishwasher was activated. The following takes place:</p> <ul style="list-style-type: none"> - If you do not close the door within four seconds of the last press of a button at program start - If the door is open for longer than four seconds during a program or within the delay start time. <ul style="list-style-type: none"> - Press the program selection button and close the door within four seconds. |
| <p>Detergent residue is left in the dispenser at the end of a program.</p> | <p>The dispenser was still damp when detergent was added.</p> <ul style="list-style-type: none"> - Make sure the dispenser is dry before adding detergent. |
| <p>The dispenser cover cannot be closed.</p> | <p>Detergent residue is blocking the latch.</p> <ul style="list-style-type: none"> - Remove the detergent residue. |
| <p>The inside of the door and/or the interior walls are wet after a program has finished.</p> | <p>This is caused by the drying system and does not indicate a fault. The moisture will dissipate after a while.</p> |
| | <p>Before fixing the fault:</p> |

| | |
|--|--|
| Water remains in the wash cabinet at the end of a program. | - Turn the dishwasher off with the  button. |
| | The filter system in the wash cabinet is clogged. - Clean the filter system |
| | The drain pump or non-return valve is blocked. - Clean the drain pump or the non-return valve |
| | The drain hose is kinked. - Remove the kink. |

Noises

| Problem | Possible cause and solution |
|--|---|
| There is a knocking noise in the wash cabinet. | A spray arm is hitting the dishes. - Interrupt the program, and rearrange the items which are obstructing the spray arm. |
| There is a rattling noise in the wash cabinet. | Dishes is moving around in the wash cabinet. - Interrupt the program and rearrange loose pieces. |
| | A foreign object (e.g., a cherry pit) has become lodged in the drain pump. - Remove the foreign object from the drain pump (see “Maintenance - Cleaning the drain pump and non-return valve”). |
| There is a knocking noise from the water pipe | This may be caused by the installation or the diameter of the water pipe. - This has no influence on dishwasher function. If in doubt, contact a suitably qualified plumber. |

Poor cleaning results



| Problem | Possible cause and solution |
|---|--|
| <p>The dishes are not clean.</p> | <p>The dishes were not loaded correctly.</p> <ul style="list-style-type: none"> - See notes in “Loading the dishwasher”. |
| | <p>The program was not powerful enough.</p> <ul style="list-style-type: none"> - Select a more intensive program |
| | <p>There is some stubborn soiling even though most of the dishware is only lightly soiled (e.g., with tea stains).</p> <ul style="list-style-type: none"> - Select the “Adjust Automatic” program option |
| | <p>Not enough detergent was dispensed.</p> <ul style="list-style-type: none"> - Use more detergent, or change your detergent. |
| | <p>Items are blocking the path of the spray arms.</p> <ul style="list-style-type: none"> - Rearrange the items so that the spray arms can rotate freely. |
| | <p>The filter system in the base of the wash cabinet is not clean or is not correctly fitted. This may cause the spray arm jets to get blocked.</p> <ul style="list-style-type: none"> - Clean and/or fit the filter system correctly. - Clean the spray arm jets if necessary |
| | <p>The non-return valve is open and blocked. Dirty water has flowed back into the wash cabinet.</p> <ul style="list-style-type: none"> - Clean the drain pump and the non-return valve |
| <p>Smearing appears on glassware and cutlery. There is a bluish sheen on the surface of glassware; film can be wiped off.</p> | <p>The rinse aid dosage is set too high.</p> <ul style="list-style-type: none"> - Reduce the dosage |
| | <p>The rinse aid dosage is set too low or the rinse aid reservoir is empty.</p> |



| | |
|---|---|
| Dishes is not dry or cutlery and glasses are spotty. | - Replenish the reservoir, increase the dosage, or change the brand of rinse aid |
| | Dishes was taken out of the cabinet too soon. - Leave it in for longer |
| | Combination tabs have been used which have impaired drying performance. - Change your detergent, or replenish the rinse aid |
| Glasses have a brownish-blue discoloration; the deposit cannot be wiped off. | Detergent deposits. - Switch to another detergent. |
| Glasses are dull and discolored; the deposit cannot be wiped off. | The glassware is not dishwasher-safe. The surfaces are affected. - There is no remedy. Purchase glassware which is dishwasher-safe. |
| Tea or lipstick stains have not been completely removed. | The wash temperature of the selected program was too low. - Select a program with a higher wash temperature. |
| | The bleaching effect of the detergent is too low. - Switch to another detergent. |
| Plastic parts are discolored. | Natural dyes, e.g., from carrots, tomatoes, or ketchup may be the cause. The amount of detergent used or its bleaching effect was not sufficient to deal with natural dyes. - Use more detergent Discoloration is irreversible. |
| White residue is visible on dishes and cutlery, clouding occurs on glassware; this film can be wiped off. | The rinse aid dosage is too low. - Increase the dosage |
| | An unsuitable Tab detergent has been used. |

| | |
|--------------------------------------|--|
| | - Change your detergent. |
| There are rust stains on the cutlery | The affected items are not corrosion resistant. - There is no remedy. Purchase cutlery which is dishwasher-safe. |

Cleaning the drain pump and non-return valve

If the water has not been pumped away at the end of a program, the drain pump or the non-return valve might be blocked. They are, however, easy to clean.

- Disconnect the dishwasher from the electrical supply. Turn off the dishwasher and withdraw the plug.
- Take the filter system out of the wash cabinet.
- Scoop the water out of the wash cabinet using a suitable container or utensil.

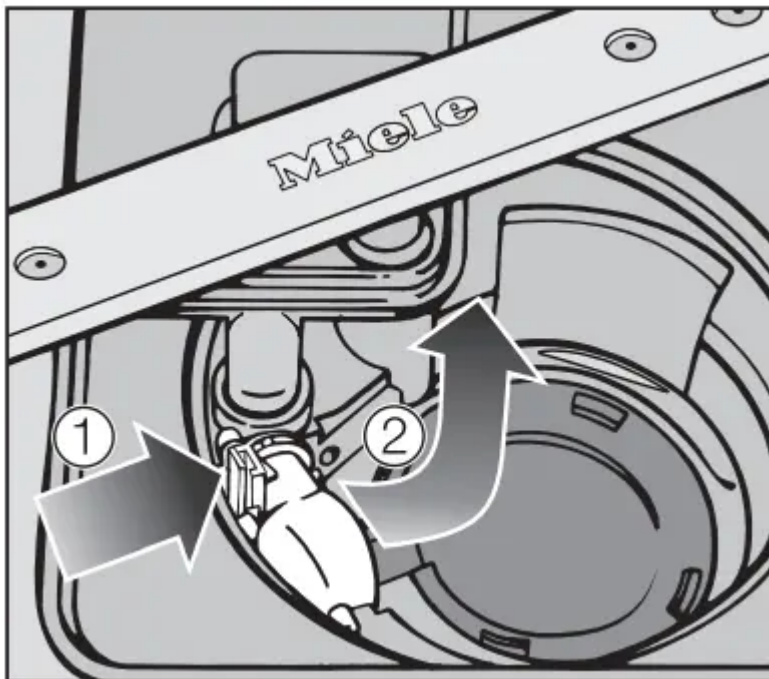

- Press the catch for the non-return valve inwards (1).
- Tilt the non-return valve inwards until it is released (2).
- Rinse it thoroughly under running water and remove any dirt from the nonreturn valve.

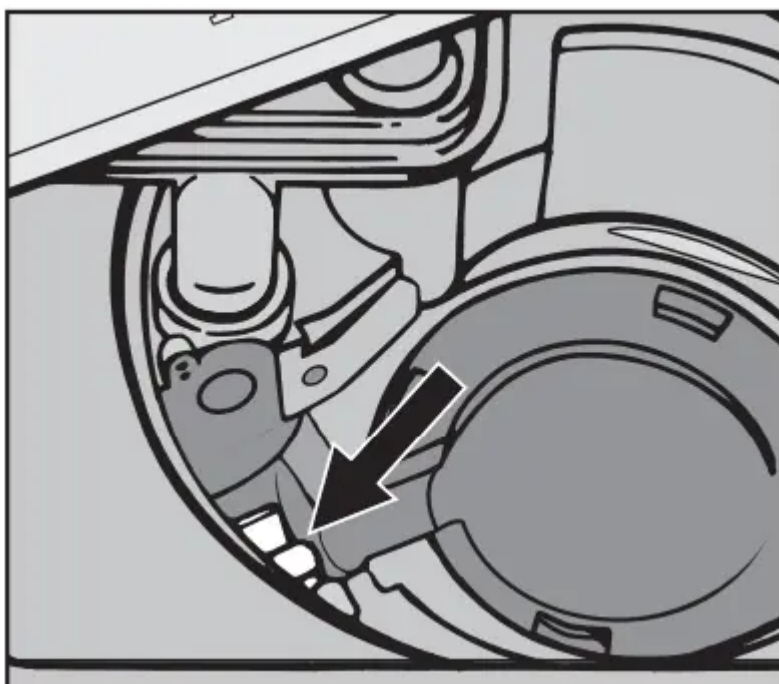

The drain pump is located underneath the non-return valve (see arrow).

- Remove all foreign objects from the drain pump (glass or bone splinters). Before returning the non-return valve, check that the drain pump is not blocked. Spin the impeller several times in both directions to check for obstructions.
- Carefully reinsert the non-return valve and secure it with the locking clamp.

WARNING:

- Make sure the locking clamp clicks into place!
- Be careful not to damage any delicate components when cleaning the drain pump and the non-return valve.

Warning

This content is compiled from multiple sources and is provided for reference purposes only. It may not be complete or fully applicable to all situations. If you are unable to resolve your issue, please contact the product manufacturer or an authorized service provider for official support.