

## Setting up your side-by-side refrigerator

### GETTING READY TO INSTALL THE REFRIGERATOR

Congratulations on the purchase of your Samsung Side-By-Side Refrigerator. We hope you will enjoy the many state-of-the-art features and efficiencies that this new appliance has to offer.

#### Selecting the best location for the refrigerator

**Choose:**

- A location with easy access to a water supply.
- A location without direct exposure to sunlight.
- A location with level (or nearly level) flooring.
- A location with enough space for the refrigerator doors to open easily.
- A location that provides sufficient space to the right, left, back, and top for air circulation.
- A location that allows you to move the refrigerator easily if it needs maintenance or service.

If your refrigerator is not level, the internal cooling system may not work correctly.

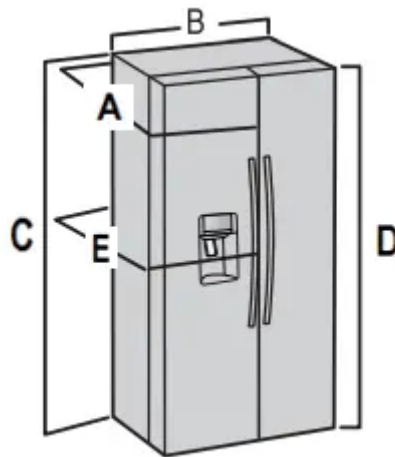

MODEL	RS25H5111** / RS25H5121**	
Depth "A"	34 "	(864 mm)
Width "B"	35 3/4 "	(908 mm)
Height "C"	68 1/2 "	(1740 mm)
Overall Height "D"	70 "	(1778 mm)
Depth "E"	36 5/8 "	(930mm)

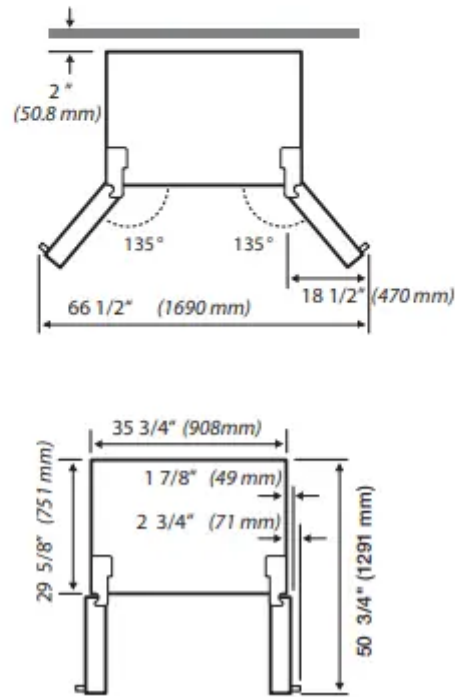

### When moving your refrigerator

To prevent floor damage, be sure the front leveling legs are in the up position (above the floor). Refer to 'Leveling the refrigerator' in the manual page 14).

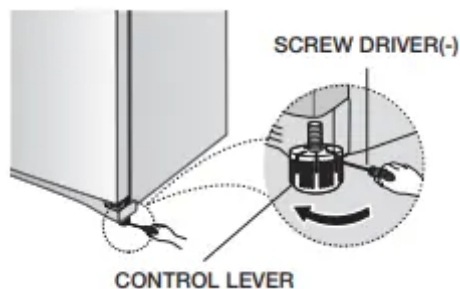

### Flooring

For proper installation, you must place this refrigerator on a level, hard surface that is the same height as the rest of the floor.

This surface should be strong enough to support a fully loaded refrigerator.

To protect the finish of the flooring during installation, cut a large section of the cardboard carton and place it under the refrigerator where you are working.

When moving the refrigerator, you need to pull and push it straight forwards or back.

Do not wiggle it from side to side.

When installing, servicing, or cleaning behind the refrigerator, be sure to pull the unit straight out and push back in straight after finishing.



- Make sure you disconnect the water supply line BEFORE removing the freezer door. To avoid damage, refer to 'Separating the water line from the refrigerator' in the manual (page 12)

## **SETTING UP THE REFRIGERATOR**

### **Installing the handles**

Take the handles out of the right side door.



### How to install the handles

Orient each handle so that the end with the sticker attached is at the top and the holes with the tightening screws are facing each other.

Then, follow the directions below to install each handle.

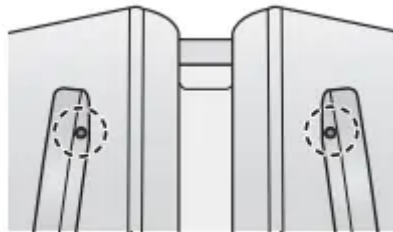

By using Phillips screwdriver, fix the screw optional) and then put the handle on the fixer by sliding them down firmly.

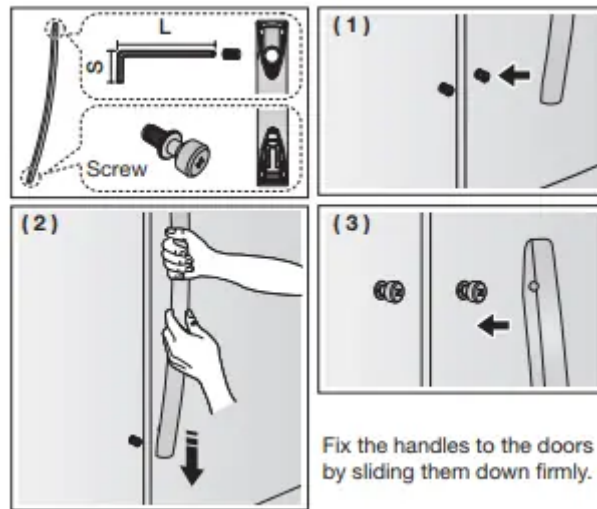

By using L- wrench, fix the screw with the longer part of it and then fully tighten up with the shorter part.



## REMOVING THE REFRIGERATOR DOORS

If your entrance won't allow the refrigerator to pass easily through it, you can remove the refrigerator doors.

To remove the doors, follow the steps below. If you do not need to remove the doors, go to "Leveling the Refrigerator" on page 14.

### Tools You'll Need

#### 1. Remove the Front Leg Cover

Open both the freezer and refrigerator doors. Unscrew the three screws holding the front leg cover in place by turning them counter-clockwise. When the screws are loose, remove the front leg cover.

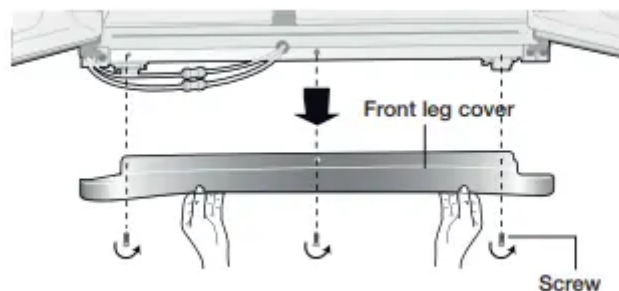

## 2. Separate the water supply line from the refrigerator

Remove two water lines by pressing the each coupler ( 1 ) and pulling the water lines ( 2 ) away

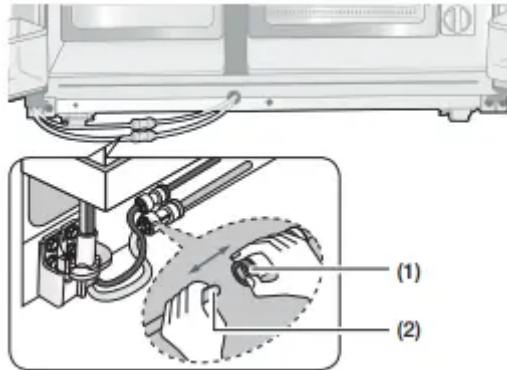

## 3. Remove the freezer door

**A few things to mention first.**

- Make sure that you lift the door straight up so the hinges are not bent or broken.
- Be careful not to pinch the water tubing and wire harness on the door.
- Place doors on a protected surface to prevent scratching or damage.
- Is necessary, have two people disassemble the doors.

1. With the Freezer door closed, remove the upper hinge cover ( 1 ) using a screwdriver, and then disconnect the wires by gently pulling them apart ( 2 ).

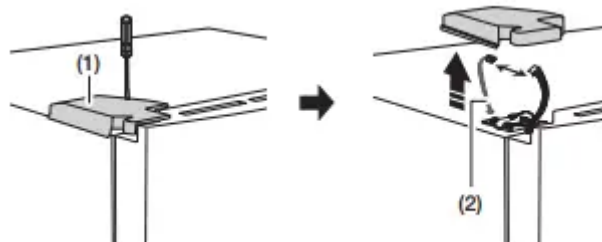

2. Remove the hinge bolts ( 3 ) with a 10 mm Socket Wrench.

Remove the ground screw ( 4 ) by turning it counter-clockwise.

Take off the upper hinge ( 5 ) in the direction of the arrow.

Take care that the door does not fall on you.

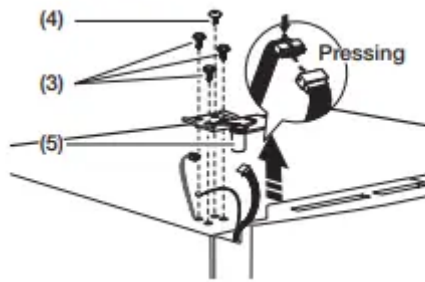

3. Open the Freezer door, and then remove the door from the lower hinge ( 6 ) by carefully lifting it up ( 7 ).

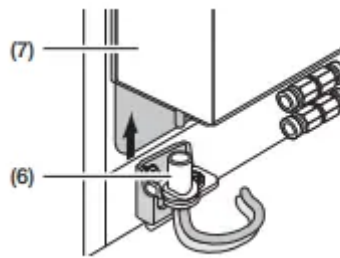

4. Remove the lower hinge ( 8 ) from the lower hinge bracket ( 9 ) by lifting the lower hinge up in the direction of the arrow.

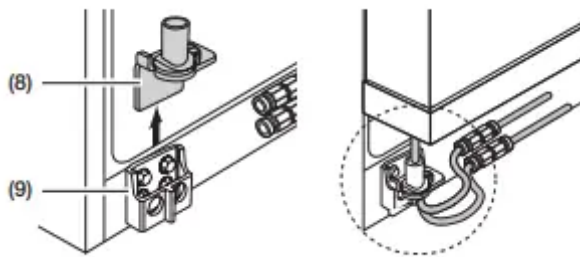

#### 4. Remove the fridge door

1. With the door closed, remove the upper hinge cover ( 1 ) using a screwdriver.

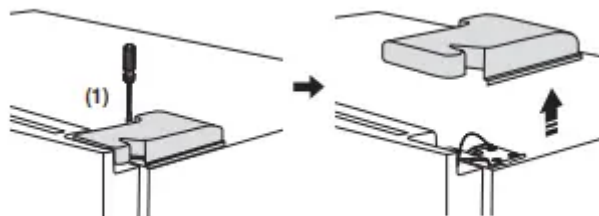

2. Remove the hinge bolts ( 2 ) with a 10 mm Socket Wrench.

Remove the ground screw ( 3 ) by turning it counter-clockwise.

Take off the upper hinge ( 4 ) in the direction of the arrow.

Take care that the door does not fall on you.

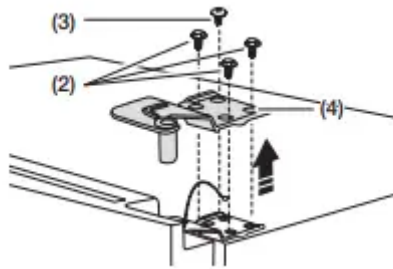

3. Remove the door from the lower hinge ( 6 ) by lifting the door ( 7 ).

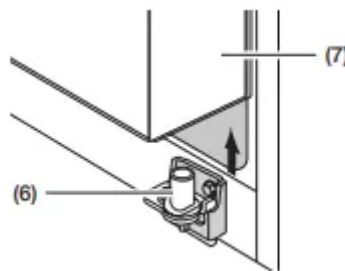

4. Remove the lower hinge ( 8 ) from the lower hinge bracket ( 9 ) by lifting the lower hinge up in the direction of the arrow.

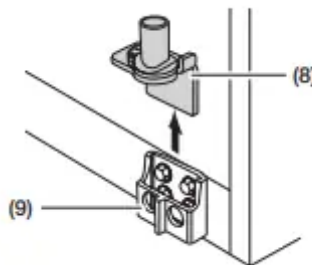

### **Re-attaching the Fridge Door**

To re-attach the fridge door, replace parts in reverse order.

### **Re-attaching the Freezer Door**

To re-attach the freezer door, replace parts in reverse order.

### **Re-attaching the Water Supply Lines**

1. The Water Lines must be fully Inserted into the center of the transparent coupler to prevent water leakage from the dispenser.
2. Insert the 2 clips in the install pack as shown below, and then confirm that each clip holds the line firmly.

## LEVELING THE REFRIGERATOR

Make sure the refrigerator is level so that you can make final adjustments.

Use a level to test if the refrigerator is level both side to side and back to front.

If the refrigerator is not level, you will not be able to get the doors perfectly even, which may cause moisture condensation and increased energy bills.

**Before levelling the refrigerator, remove the front leg cover.**

Open both the freezer and refrigerator doors. Unscrew the three screws holding the front leg cover in place by turning them counter-clockwise. When the screws are loose, remove the front leg cover.



**When the Freezer part is lower than the Fridge part.**

Insert a flat-blade screwdriver into a slot on the Freezer Leg, then turn it clockwise.

**When the Fridge part is lower than the Freezer part.**

Insert a flat-blade screwdriver into a slot on the Fridge Leg, then turn it clockwise.

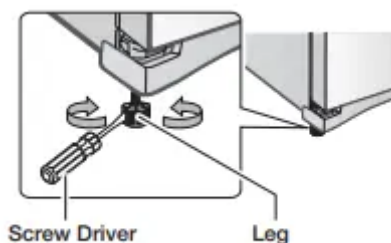

## MAKING MINOR ADJUSTMENTS TO THE DOORS

A level refrigerator is necessary for getting the doors perfectly even.

Make sure your refrigerator is level before you begin.

If you need help leveling, review the previous section on leveling the refrigerator.

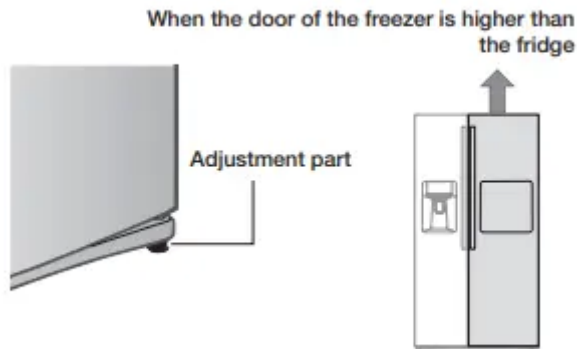

The process for adjusting each door is the same. Open the doors and adjust them, one at a time, as follows:

1. Unscrew the nut ( 1 ) from the lower hinge until it reaches the upper end of the bolt ( 2 ).

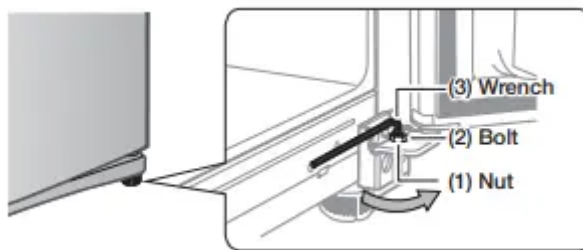

2. Adjust the height difference between the doors by turning the bolt ( 2 ) clockwise ( ↻ ) or counter clockwise ( ↺ ).

3. After adjusting the doors, turn the nut ( 1 ) clockwise ( ↻ ) until it reaches the lower end of the bolt, then tighten the bolt again with the wrench ( 3 ) to fix the nut in place ( 1 ).



## INSTALLING THE WATER DISPENSER LINE

A water dispenser is one of the helpful features on your new Samsung Refrigerator.

To help promote better health, the Samsung water filter removes unwanted particles from your water.

However, it does not sterilize or destroy microorganisms.

You may need to purchase a water purifying system to do that.

The water line also connects to the ice maker.

For the ice maker to operate properly, water pressure of 20 ~ 125 psi (138 ~ 862 kPa) is required.

If the refrigerator is installed in an area with low water pressure (below 20 psi), you can install a booster pump to compensate for the low pressure.

After you have connected the water line, make sure the water storage tank inside the refrigerator is properly filled.

To do this, press the water dispenser lever until water runs from the water dispenser.

### **Connecting to the water supply line**

1. First, shut off the main water supply line and turn the ice-maker off.
2. Locate the nearest cold water drinking water line.
3. Install the pipe clamp and shut off valve.
4. Connect the water line installation kit to the shut off valve.

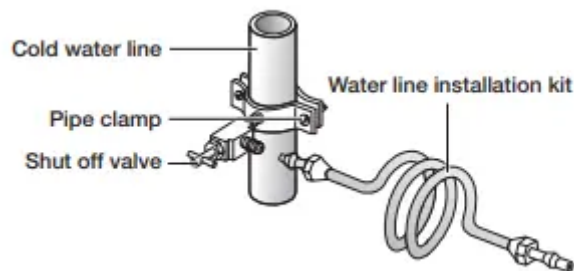

### **Connecting the water supply line to the refrigerator**

There are several items that you need to purchase to complete this connection.

You may find these items sold as a kit at your local hardware store.

Use Copper Tubing	Use Plastic Tubing
<ul style="list-style-type: none"> <li>• ¼" copper tubing</li> <li>• ¼" compression nut (1pc)</li> <li>• Ferrule (2pc)</li> </ul>	<ul style="list-style-type: none"> <li>• ¼" plastic tubing → Molded end (Bulb)</li> <li>• ¼" compression nut (1pc)</li> </ul>

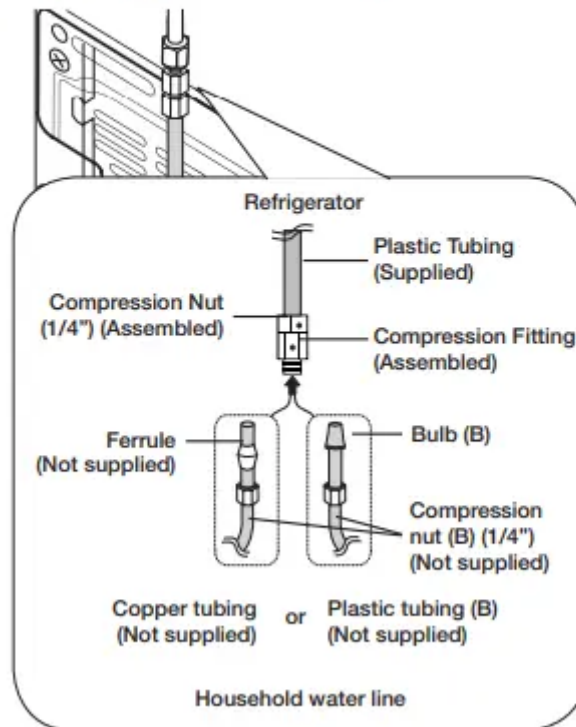

1. Connect the household water line to the assembled compression fitting.

- If you are using copper tubing, slip the compression nut ( B ) (not supplied) and ferrule (not supplied) on the copper tubing (not supplied) as shown.

- If you are using plastic tubing ( B ), insert the molded end (Bulb) of the plastic tubing ( B ) into the compression fitting.

2. Tighten the compression nut ( B ) onto the compression fitting.

Do not over-tighten the compression nut ( B ).

3. Turn the water on and check for any leaks inside the refrigerator, around the water filter, and in any connection areas.

If you find water drops or leaks, turn off the main water supply.

If the leaks are in the connection areas, check the connections and, if necessary, tighten.

If there are leaks in the refrigerator, check the water filter and confirm it is in the locked position.

Turn on the water supply and check for leaks again.

4. Plug in the refrigerator.

5. Flush 3 gallons of water through the filter before drinking or using the water from the refrigerator. (Flush approximately 6 minutes.)

This will clean the water supply system and remove air from the lines.

To flush, press the Water button, and then press a large glass or cup against the water dispenser lever. Fill the glass, empty it into the kitchen sink after it is filled, and then repeat.

6. Open the refrigerator door and make sure there are no water leaks coming from the water filter.

- After you turn on the refrigerator, let the ice maker make ice for 1 to 2 days.
- Over that period of time, throw out the first 1 or 2 buckets of ice the ice maker makes to ensure all impurities have been removed from the water line.
- Only connect the water line to a drinkable water source.
- If you have to repair or disassemble the water line, cut off 1/4" of the plastic tubing to make sure you get a snug, leak-free connection.
- You can test the water line quickly using a paper cup. Under normal conditions, the water dispenser can fill a 5.75 oz. (170 cc) cup in about 10 seconds.

## **COMPLETING THE SET UP**

Now that you have your new refrigerator installed in place, you are ready to set up and enjoy the features and functions of the appliance.

By completing the following steps, your refrigerator should be fully operational.

1. Make sure your refrigerator is in an appropriate location with reasonable clearance between it and the wall. Refer to installation instructions in this manual.
2. Once the refrigerator is plugged in, make sure the interior light comes on when you open the doors.
3. Set the Temperature control to the coldest temperature and wait for an hour. The freezer will get slightly chilled and the motor will run smoothly. Reset the refrigerator and freezer to the temperatures you want.
4. After you plug the refrigerator in, it will take a few hours to reach the appropriate temperature. You can store food and drinks in the refrigerator after the temperature is sufficiently cool.

### **Preventing Power Cord Damage**

To prevent power cord damage, fix any excess power cord to the top rear of the refrigerator as shown in the illustration below.

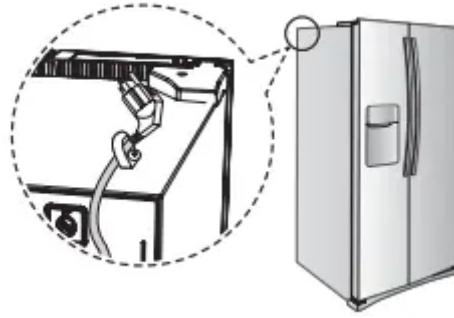

## Operating the SAMSUNG sideby-side refrigerator

### USING THE CONTROL PANEL / DIGITAL DISPLAY



#### **(1). Energy Saver (°C ↔ °F (3 sec))**

For better energy efficiency, press the Energy Saver button.

If condensation occurs on the doors, turn the Energy Saver function off.

To switch the temperature units between °C and °F. touch and hold this button for 3 seconds.

Each time you press and hold the button, the °C and °F temperature modes alternate and the °C or °F icon lights up, indicating your selection.

#### **(2.)Freezer (Power Freeze (3 sec))**

Press the Freezer button to set the freezer temperature between 5 °F (-15 °C) and -8 °F (-23°C).

Press and hold the Freezer button for 3 seconds to activate the Power Freezer function to decrease the time needed to freeze products in the Freezer.

This can be helpful if you need to quickly freeze items that spoil easily or if the temperature in the freezer has warmed dramatically (For example, if the door was left open).

If you need to freeze a large amount of food, activate the Power Freeze function at least hours before you put the food into the freezer

#### **(3).Lighting (Control Lock (3 sec))**

Press the Lighting button to turn on the dispenser LED lamp.

If you press and hold the Lighting button for seconds, all buttons will be locked and the dispenser pad will not work.

#### **(4).Fridge (Power Cool (3 sec))**

Press the Fridge button to set the Fridge temperature between 44 °F (7 °C) and 34 °F (-1°C).

Press and hold the Fridge button for 3 seconds to decrease the time needed to cool products in the Refrigerator.

#### **(5). Ice (Ice Maker Off (3 sec))**

Press the Ice button to select cubed ice, crushed ice, or to turn the ice dispenser off.

Press and hold the Ice button for 3 seconds to turn the ice making function off.

Press and hold the Ice button again for 3 seconds to turn the ice making function back on.

#### **(6).Water (Reset Filter (3 sec))**

Press the Water button to turn the water dispenser on.

Press and hold the Water button for 3 seconds after changing the filter to reset the water filter indicator.

## **USING THE CONTROL PANEL**

### **Freezer/Fridge (Temperature adjustment)**

Press the Freezer or Fridge button repeatedly until the desired temperature is set.

Each time you press the Freezer or Fridge button, the temperature indicator will change in the order shown below.

- Freezer

0 °F → -1 °F → -2 °F → -3 °F → -4 °F → -5 °F →  
-6 °F → -7 °F → -8 °F → 5 °F → 4 °F → 3 °F →  
2 °F → 1 °F → 0 °F  
(-18 °C → -19 °C → -20 °C → -21 °C → -22 °C →  
-23 °C → -15 °C → -16 °C → -17 °C → -18 °C)

- Fridge

37 °F → 36 °F → 35 °F → 34 °F → 44 °F → 43 °F  
→ 42 °F → 41 °F → 40 °F → 39 °F → 38 °F →  
37 °F  
(3 °C → 2 °C → 1 °C → 7 °C → 6 °C → 5 °C →  
4 °C → 3 °C)

## **Power Freeze**

This icon lights when you activate the Power Freeze function.

Power Freeze generates cold air for up to 50 hours continuously, chilling the freezer more quickly.

This function is useful when you need to decrease the temperature in the freezer quickly or to make more ice rapidly.

When you have enough, just press and hold the Freezer/Power Freeze (3 sec) button again for 3 seconds to cancel the Power Freeze function.

## **Energy Saver**

This icon lights when you activate the Energy Saver function.

The Energy Saver function is automatically set to ON” when power is supplied to the Refrigerator.

If condensation occurs on the doors, turn the Energy Saver function off.

## **Lighting**

This icon lights when you activate the Lighting function.

When the icon is lit, the dispenser light (under the display) is on continuously.

If you want the Dispenser lamp to come on only when some one uses the dispenser, press the

Lighting button to turn the continuous mode off.

## **Control Lock**

This icon lights when you activate the Lock function.

When the Control Lock icon is lit, all the panel buttons, including the Ice button and the dispensers, are locked and de-activated.

Press and hold the Lighting/Control Lock button for 3 seconds to turn Control Lock off and reactivate the panel buttons.

## **Filter Indicator**

This icon turns red when you need to change the filter, usually after the refrigerator has dispensed about 300 gallons of water (or after about 6 months). The icon will blink red for several seconds

The filter Indicator will be Off when you initially insert the water filter.

## **Power Cool**

This icon lights when you activate the Power Cool function.

The Power Cool function is great for a quick fridge cool down.

When you activate the Power Cool function, the temperature inside the Fridge decreases for about two and a half hours.

When you want to turn Power Cool off, press and hold the Fridge/Power Cool (3 sec) button again for 3 seconds.

## **Cubed** , **Crushed**

Enjoy cubed or crushed ice by selecting your preference from the digital control panel.

The ice type light indicates the type of ice that is currently chosen.

## **Ice Off**

This icon lights when you activate the Ice Off function.

When the Ice Off icon is lit, the ice maker is turned off.

## **Water**

This icon lights when you activate the Water function.

## **Display Off**

To conserve energy the Panel Display turns off automatically under the following conditions: When no button has been pressed, when no doors have been opened, or when no Dispenser Lever has been pushed for a period of time.

The icon indicating the Water or Cubed / Crushed Ice selection, however, stays on.

When you press a button, open a door, or push a Dispenser Lever, the Panel Display will turn on again.

Except for the Water and Ice buttons, all function buttons will become operational after you remove your finger from the button you are currently pressing.

## **Demo Mode**

Cooling Off mode (also called Shop mode), is designed for use by retailers when they display refrigerators on the shop floor.

In Cooling Off mode, the refrigerator's fan motor and lights work normally, but the compressors do not run, and the refrigerator and freezer do not get cold.

To start Cooling Off mode, press and hold the Energy

Saver button, the Freezer button and the Lighting button for 5 seconds during normal operation.

The refrigerator chime sounds and O-FF appears on the display.

To cancel Cooling Off mode, press and hold the

Energy Saver button, the Freezer button and the Lighting button again for 5 seconds, until the chime sounds.

Cooling Off mode is only available on refrigerators sold in the U.S.



## USING THE ICE AND COLD WATER DISPENSER

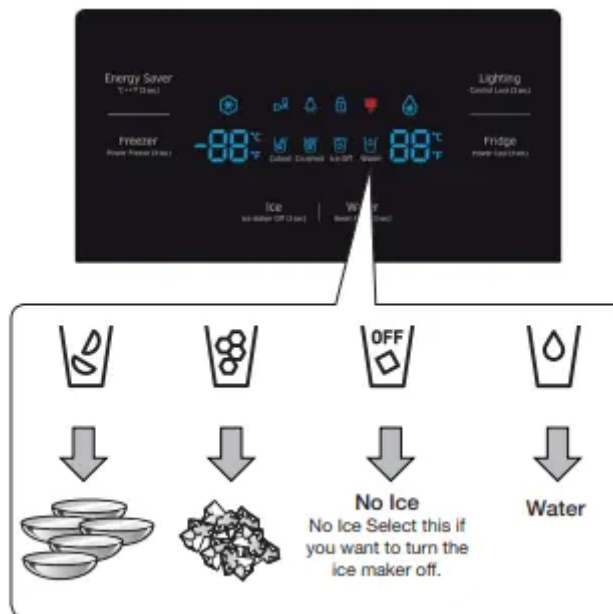

### Using the water dispenser

Press the Water button on the control panel.

Place a cup or glass under the water outlet, and then push the cup or glass against the dispenser pad until you hear a "click".

Make sure the glass is in line with the dispenser to prevent the water from splashing out.



### **To get colder water**

- The dispensed water is cool, not icy cold.
- When you want colder water with ice, dispense ice to your glass first before filling it with water to prevent water from splashing out.

### **Using the ice dispenser**

Press the Ice button to select the type of ice you want.

Place your cup under the ice outlet and push gently against the dispenser pad.

Make sure the glass is in line with the dispenser to prevent the ice from bouncing out.

When you select cubed ice after selecting crushed ice, a small amount of residual crushed ice might be produced.

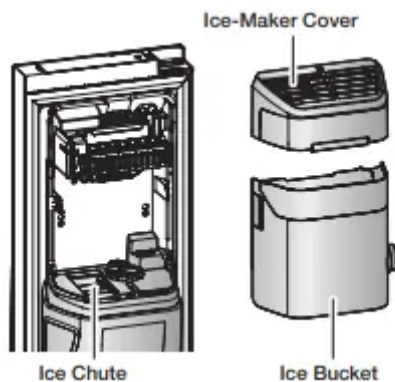

## **STORING FOOD**

The Samsung Side-By-Side Refrigerator has been designed to provide you with maximum space saving features and functions.

Here are some of the customized compartments we have created to keep your food fresher, longer.

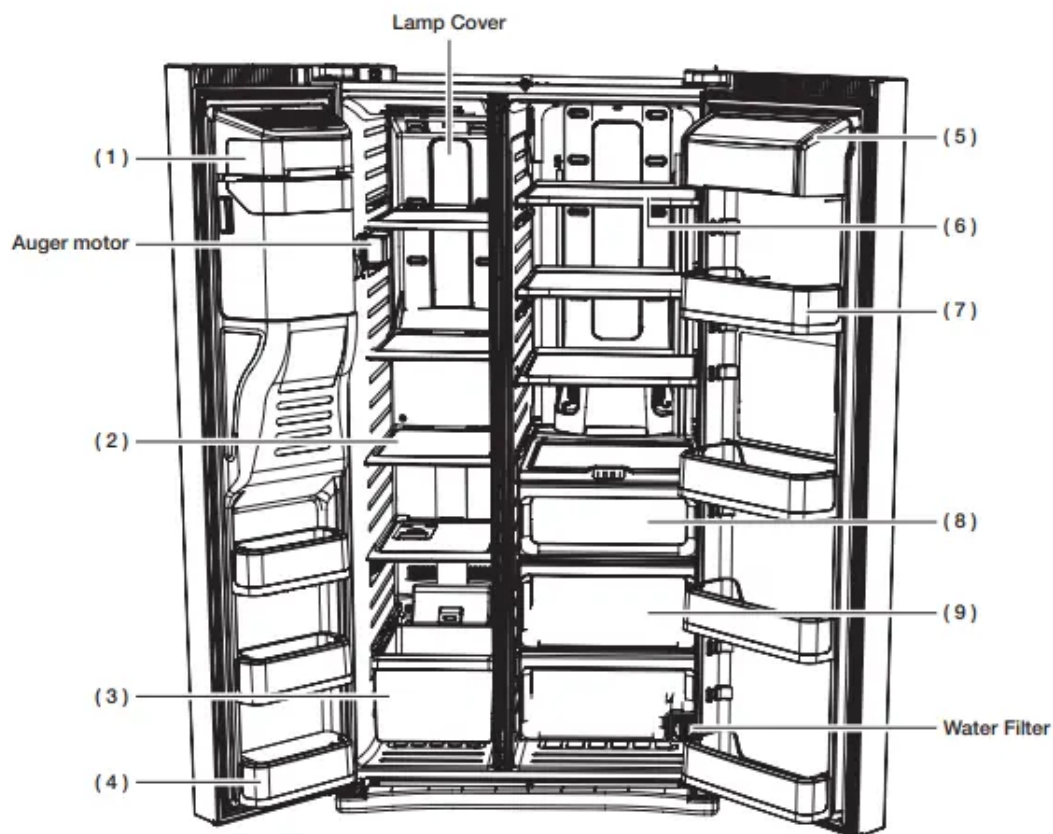

### Storing food in the freezer

#### (1)Ice Maker Bucket

Designed to store lots of ice easily.

#### (2)Shelves

Can be used to store all types of frozen food.

#### (3)Drawers

Best used to store meats or dry foods.

Stored food should be wrapped securely using foil or other suitable wrapping materials or containers.

### Storage in the fridge

#### (4)Door Bins

Can be used for small packages of frozen food.

#### (5)Dairy Bin

Can be used to store smaller dairy items like butter or margarine, yogurt or cream-cheese bricks.

#### (6)Shelves

Designed to be crack-resistant.

They can be used to store all types of food and drinks.

Circular marks on the glass surface are normal phenomenon and can usually be wiped clean with a damp cloth.

### **(7)Door Bins**

Designed to handle large, bulky items such as gallons of milk or other large bottles and containers.

### **(8)Coolselect Zone™ (RS25H5121)**

Useful for chilling beverages quickly and for thawing frozen foods.



- Fresh (default) : can be used as mini-fridge in the fridge. The temp will be similar to that of the surroundings. Thaw : Press the
- Thaw button, and then put food you want to thaw in the Coolselect Zone.
- Quick Cool : Press Quick Cool to cool beverages quickly

### **(9)Fruit & Vegetable Drawer**

Used to preserve the freshness of your stored vegetables and fruits.

## **Cleaning and maintaining your side-by-side refrigerator**

### **REMOVING THE FREEZER/ FRIDGE ACCESSORIES**

#### **1.Door Bin/Dairy Bin**

- Firmly grab the door bin with both hands and lift it up gently to remove.

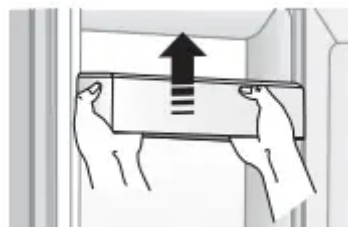

#### **2. Shelves (Freezer/Fridge)**

- Remove the shelf by pulling it out to the point where there is a gap in the shelf support as shown in the circled figure. Then, lift up the right side of the shelf and pull it out.

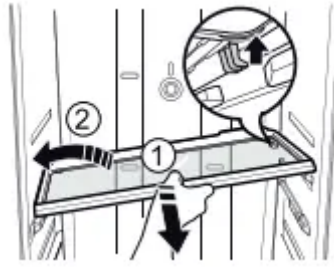

### 3. Drawer

- Pull the drawers out fully then lift slightly to remove. (Drawer/Fruit & Vegetable Drawer)



### 4. Ice Bucket (Freezer)

- Remove the Icemaker Bucket by lifting up and pulling it out slowly.
  - Grip the handle as shown in the figure.
  - Lift the low part slightly.
  - Take the ice bucket out slowly.



## CLEANING THE REFRIGERATOR

Caring for your Samsung Side-By-Side Refrigerator prolongs its life and helps keep it odor and germfree.

### Cleaning the Interior

Clean the inside walls and accessories with a mild detergent and then wipe dry with a soft cloth.

You can remove the drawers and shelves for a more thorough cleaning.

Just make sure to dry them before putting them back into place.

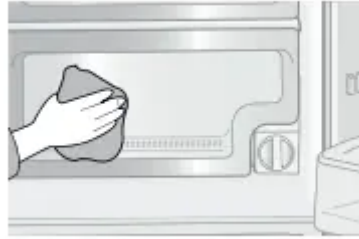

### **Cleaning the Exterior**

Wipe the digital panel and display panel with a clean, soft cloth.

Spray water onto the cleaning cloth instead of spraying directly on the surface of the refrigerator.

This helps ensure an even distribution of moisture to the surface.

The doors, handles, and cabinet surfaces should be cleaned with a mild detergent and then wiped dry with a soft cloth.

To keep your appliance looking its best, the exterior should be polished once or twice a year.

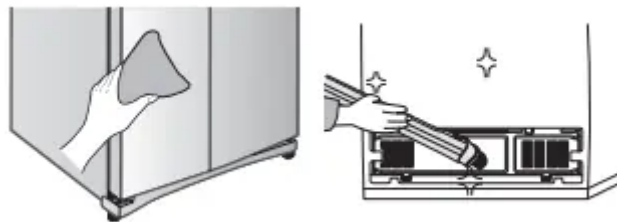

### **Cleaning the rubber door seals**

If the rubber door seals are dirty, the doors may not close properly, and the refrigerator will not operate efficiently.

Keep the seals free of grit or grime by cleaning them with a mild detergent and damp cloth. Wipe dry with a clean, soft cloth.



### **Changing the LED type lighting**

Do not disassemble or replace the LED type lighting.

To change the LED type lighting, contact a Samsung service center.

## REPLACING THE WATER FILTER

To make changing the water filter easier, you may want to shut off the water supply, and then drain any water remaining in the water line by pressing the Water button and then pressing a glass against the water dispenser pad.

1. Turn the water filter 90° counter-clockwise.



2. Pull the water filter out of the filter housing.



3. Insert a new water filter into the filter housing.



4. Turn the new water filter 90° clockwise.



5. Press and hold the Water button for 3 seconds after changing the filter to reset the filter indicator.

Confirm the indicator turns blue.

When you replace the water filter, some water may leak from the water filter housing.

Make sure to wipe up any leakage that may have occurred.

### **Removing residual matter from inside the water supply line after installing a new filter**



1. Turn ON the main water supply.
2. Press the Water button on the control panel. Place a cup or glass under the water outlet, and then push the cup or glass against the dispenser pad until you hear a "click".
3. Flush 3 gallons of water through the filter. (Flush approximately 6 minutes.) This will clean the water supply system and remove air from the lines.
4. Additional flushing may be required in some households.
5. Open the refrigerator door and make sure there are no water leaks coming from the water filter.

### **USING THE ICE MAKER**

- To Remove the Ice Bucket.
  - Hold the handle as shown in figure1.
  - Lift up, and then pull the bucket out slowly.
  - After you have reinstalled the ice bucket, press and hold the ICE button for 6 seconds.



Figure 1

- Normal Operation

- Any sounds you hear when the ice maker dumps ice into the bucket are part of normal operation.
- Ice may clump in the bucket if you do not dispense ice for long periods of time.
- If this occurs, remove all the ice and empty the bucket.
- If ice does not come out, check for any ice stuck in the chute and remove it.
- The first batch of ice cubes after installation may be small because air has entered the water line. Any air will be purged during normal use.



- When Ice Off blinks on the display panel, reinsert the bucket and/or make sure it's installed properly.
- When the door is open, the Ice and water dispenser do not work.
- If you close the door hard, it may cause water to spill over the ice maker.
- To prevent the ice bucket from falling, use both hands when removing it.
- To prevent injury, be sure to clean up any ice or water that may have dropped on the floor.
- Do not let the children hang on the ice dispenser or on the bucket.
- They may get hurt.
- Be sure not to put your hand or any object into the ice chute.

- It may cause personal injury or damage mechanical parts.
- Use care when storing food in plastic bags in the freezer. Incorrectly stored bags can get caught in the ice bucket's Auger Motor and prevent the refrigerator from dispensing ice or cause the freezer door to open unexpectedly

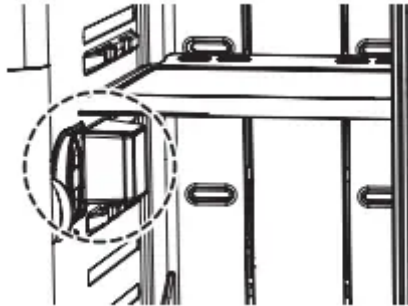

## Troubleshooting

- **The refrigerator does not work at all or it does not chill sufficiently.**
  - Confirm that the power plug is properly connected.
  - Is the temperature control on the display panel set to the correct temperature? Try setting it to a lower temperature.
  - Is the refrigerator in direct sunlight or located too near a heat source?
  - Is the back of the refrigerator too close to the wall and therefore keeping air from circulating?
  - Check if the Cooling Off function is on. If the Freezer/Fridge temperature indicator is moving, refer to page 19 to cancel the Cooling Off function.
- **The food in the fridge is frozen.**
  - Is the temperature control on the display panel set to the correct temperature?
  - Try setting it to a warmer temperature.
  - Is the temperature in the room very low?
  - Did you store the food with a high water content in the coldest part of the fridge?
- **You hear unusual noise or sounds.**
  - Confirm that the refrigerator is level and stable.
  - If the refrigerator's water supply line is not connected and water is not being supplied to the refrigerator, the refrigerator will make unusual noises if the ice maker is on or if you push the water dispenser lever. To stop the noises,

press the Ice Type button for seconds until the Ice Off icon lights indicating that the ice maker is off.

- You hear a ticking sound from inside the refrigerator. This is normal and occurs because various parts contract or expand in response to temperature changes in the refrigerator interior.

- **The front corners of the appliance are hot and condensation is occurring.**

- Some heat is normal as anti-condensators are installed in the front corners of the refrigerator to prevent condensation.
- Is the refrigerator door ajar? Condensation can occur when you leave the door open for a long time.

- **Ice is not dispensing.**

- Did you wait for 12 hours after installation of the water supply line before making ice?
- Is the water line connected and the shut-off valve open?
- Did you manually stop the ice making function?
- Make sure Ice Type is set to Cubed or Crushed.
- Is there any ice clumped within the ice maker bucket? If yes, remove the clumped ice.
- Is the freezer temperature too warm? Try setting the freezer temperature lower.

- **You can hear water bubbling in the refrigerator.**

- This is normal. The bubbling comes from the refrigerant coolant liquid circulating through the refrigerator.

- **There is a bad smell in the refrigerator.**

- Has a food item spoiled?
- Make sure that strong smelling food (for example, fish) is wrapped so that it is airtight.
- Clean out your freezer periodically and throw away any spoiled or suspect food.

- **Frost forms on the walls of the freezer.**

- Is the air vent blocked?
- Remove any obstructions so air can circulate freely.
- Allow sufficient space between the foods stored for efficient air circulation.
- Is the freezer door closed properly?

- **Water dispenser is not functioning.**

- Is the water line connected and the shut-off valve open?
- Has the water supply line tubing been crushed or kinked?
- Make sure the tubing is free and clear of any obstruction.
- Is the water tank frozen because the refrigerator temperature is too low? Try selecting a warmer setting on the main display panel.

**Warning**

This content is compiled from multiple sources and is provided for reference purposes only. It may not be complete or fully applicable to all situations. If you are unable to resolve your issue, please contact the product manufacturer or an authorized service provider for official support.

