

USING THE WASHER

Getting started

Throughout this manual, features and appearance may vary from your model.

Step 1

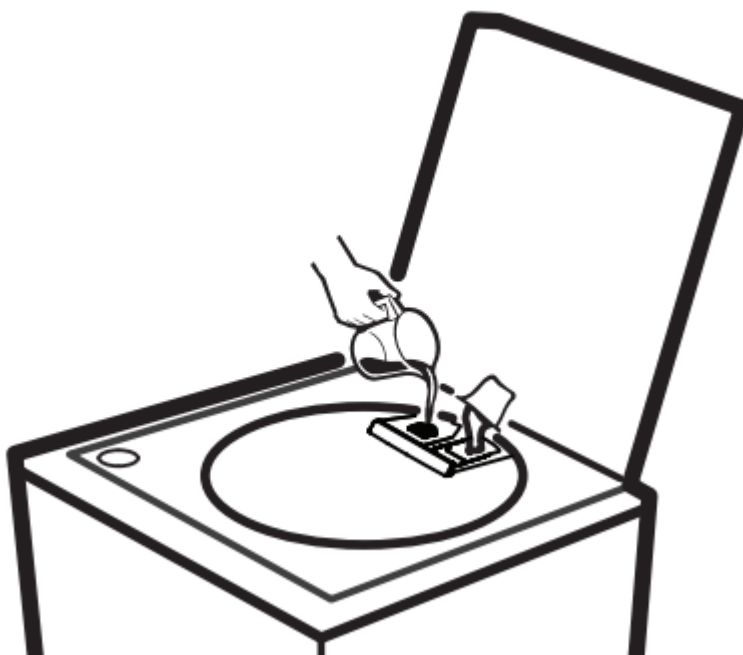

- Add fabric softener to the fabric softener dispenser.

IMPORTANT: For detergent use, see the specific dispenser section in this manual for your model.

- If using detergent packets, add to the bottom of the wash basket before adding clothes.

Step 2



- Loosely add items around agitator or Infusor. Overloading may negatively impact wash performance. See page 16 for suggested loading examples.
- Add the manufacturer's recommended amount of detergent to the top of the load after

adding clothes. We recommend the use of High Efficiency detergents such as  in your energy efficient washer.

Step 3



- Close lid.

NOTE: Unit will not start with lid open if Precise Fill is selected except on Bulky Items cycle

- Select wash cycle.
- Select wash options, including Deep Rinse (on some models) option when using fabric softener.
- Select options.

Step 4



- Press Start.

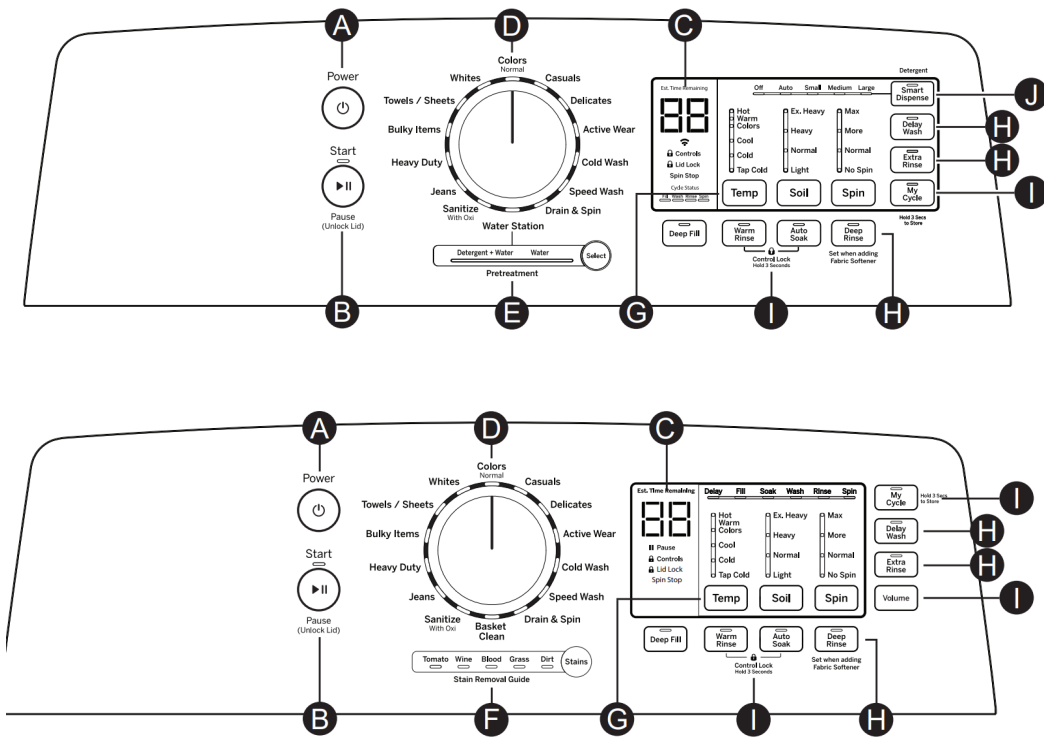

A. Power

- Press to “wake up” the display. If the display is active, press to put the washer into idle mode.

NOTE: Pressing Power does not disconnect the appliance from the power supply

B. Start/Pause

- Press Start to begin the cycle. NOTE: Unless Bulky Items cycle is selected, the lid must be closed for the washer to start cycle. If the lid is open, “Lid” will scroll across the display. During the load sensing portion of the cycle, the lid will lock and “SEnSing” will scroll across the display. When load sensing is complete, the lid will unlock. Pressing Pause will unlock the lid (if locked at that time), pause the cycle and the Start indicator light will blink.

- To continue the cycle, press Start again. If water remains in the machine, select the Drain & Spin cycle to drain basket and spin water out of the washer basket. NOTE: Machine will automatically cancel and drain when water is present and the lid is left open for 15 minutes or the unit is left in a paused state for 24 hours with the lid closed. Select cycle and press Start to begin new cycle

C. Display and Status Lights

Display: The display shows the approximate time remaining until the end of the cycle. NOTE: The cycle time is affected by how long it takes the washer to fill. This depends on the water pressure in your home. The size of the load being washed also significantly impacts cycle time, with larger loads taking longer.



In addition, this display will, “scroll” the washer status:



- bALAnCINg: Start of rebalancing cycle to redistribute clothes. Stops after rebalancing is complete.
- dELAY: When Delay Wash is initiated. Replaced with estimated time when cycle starts.
- End End of current cycle.
- FILL: “FILL” will scroll across display for the first 45 seconds of fill, afterwards the estimated end of cycle time is displayed.
- H2O SUPPLY: Can not sense water level (valves possibly turned off).
- LId: Cycle stopped because lid is open. Close the lid.
- SEnSIng: Sensing load size and type before and during fill (normal).
- PAUSE: Cycle paused because the Start/Pause button was pressed and the washer was set to Pause. Press Start button again to restart the cycle.

Cycle status lights: Shows whether the washer is in the Delay, Fill, Soak (on some models), Wash, Rinse or Spin portion of the cycle.

If an out-of-balance condition is detected by the washer, the Spin light will blink during the remaining portion of the cycle and will stay illuminated for a short time after cycle completion. When this occurs, the washer is taking actions to correct the out-of-balance condition and complete the cycle normally. In some cases, the washer may not be able to balance the load and spin up to full speed. If you notice the load is more wet than normal at the end of the cycle, redistribute the load evenly in the wash basket and run a Drain & Spin cycle.

Feature status lights indicate (see sections F and G for more details):

-  Pause - Will display when washer is paused between cycles.
-  Controls - The washer is locked - will blink once if you press any button or turn the cycle knob.

-  Lid Lock - The lid is locked. See the Control Lock description.
-  WiFi (on some models) - Will display when washer is connected via WiFi. Will blink when you are attempting to connect your device to your home WiFi.
- Spin Stop - Indicates wash basket is coasting to a stop following spin. Lid will not unlock until basket has fully come to a stop.

Consumer Help Indicator

Your washer is equipped with Consumer Help Indicator (CHI). CHI is our way to communicate a simple remedy for some situations that you can perform without the need to call for service. The chart below describes the helpful messages you may notice scrolling on your display when you return to start another load. These messages will provide simple remedies you can quickly perform.

- Spin light blinking: If an out-of-balance condition is detected by the washer, the Spin light will blink during the remaining portion of the cycle and will stay illuminated for a short time after cycle completion. When this occurs, the washer is taking actions to correct the out-of-balance condition and complete the cycle normally. In some cases, the washer may not be able to balance the load and spin up to full speed. If you notice the load is more wet than normal at the end of the cycle, redistribute the load evenly in the wash basket and run a Drain & Spin cycle.
- “H2O SUPPLY” (Water not entering washer): Check your house water supply. Did you forget to turn on one or both supply valves after installation or coming back from vacation? As soon as the message starts to scroll, the washer will initiate a 4 minute lockout period. The washer controls won’t respond/change during this time. After the 4 minutes, you can begin your cycle again. If you try to bypass the lock-out period by unplugging the washer, the 4 minute timer will start over again.
- “CAnCELEd”: “CAnCELEd” may scroll on the display if the machine was paused for longer than 24 hours or if the machine has stopped itself before the cycle completed due to certain errors. As soon as the message starts to scroll, the washer will initiate a 4 minute lock-out period. The washer controls won’t respond/change during this time. After the 4 minute period, you can begin your cycle again. If you try to bypass the lock-out period by unplugging the washer, the 4 minute timer will start over again. If the problem persists, call GE Appliances at 800. GE.CARES (800.432.2737) for service.
- “Lid”: “Lid” will be shown on display if 3 cycles have been started without opening the lid. The washer will not start another cycle until the lid is opened. Try opening, then closing the lid and starting a new cycle. If the problem persists, call GE Appliances at 800.GE.CARES (800.432.2737) for service.

D. Wash Cycles-Cycle Selector Knob

- The wash cycle controls the type of washing process. The cycle selector knob can be turned in either direction. Turning the knob after starting a cycle will stop the washer and change the cycle/options to the new selection. Press Start to begin the new cycle selection.
- The chart below will help you match the items to be washed with the best wash cycle settings. For optimal performance, select the cycle that most closely matches the items being washed.
- Selections and options shown in bold are the recommended settings for that cycle.
- Some cycles and options may not be available on some models.

Items to Wash	Cycle	Wash Temp	Soil Level	Spin Selection (Duration)	Options Available	Cycle Details
Cycle for normal, regular, or typical use for washing up to a full load of normally soiled cotton clothing.	Colors	Hot Warm Colors Cool Cold Tap Cold	Ex. Heavy Heavy Normal Light	Max More Normal No Spin	Stain Removal Guide Warm Rinse Auto Soak Deep Rinse Delay Wash Extra Rinse Power Pre-Wash	Cycle for normal, regular, or typical use for washing up to a full load of normal cotton clothing. Choose Heavy or Extra Heavy level selection and Hot water temperature selection as appropriate for your clothes load for the degree of soiling. Incorporates multiple wash periods for optimal fabric care.
Casual clothes, lightly soiled office wear.	Casuals	Hot Warm Colors Cool Cold Tap Cold	Ex. Heavy Heavy Normal Light	Max More Normal No Spin	Stain Removal Guide Deep Fill Warm Rinse Auto Soak Deep Rinse Delay Wash Extra Rinse Power Pre-Wash	Wash cycle tailored to casual clothes and office items.
Lingerie and special care fabrics with light soil.	Delicates	Hot Warm Colors Cool Cold Tap Cold	Ex. Heavy Heavy Normal Light	Max More Normal No Spin	Stain Removal Guide Deep Fill Warm Rinse Auto Soak Deep Rinse Delay Wash Extra Rinse	Utilizes an extra gentle profile and a low spin speed to provide special care for delicate fabrics. It is recommended to place delicate or ultra delicate items in mesh bags before washing.



					Power Pre-Wash	
Medium to lightly soiled athletic wear items of technical or synthetic fabrics.	Active Wear	Hot Warm Colors Cool Cold Tap Cold	Ex. Heavy Heavy Normal Light	Max More Normal No Spin	Stain Removal Guide Deep Fill Warm Rinse Auto Soak Deep Rinse Delay Wash Extra Rinse Power Pre-Wash	Cycle designed for medium to lightly soiled wear, athletic wear, technical fabrics. Includes a dual stage wash to effectively treat body odors. Use the Heavy cycle for heavily soiled clothing constructed of heavy fabric.
Small loads of lightly soiled items that are needed in a hurry. Examples include one casual wear outfit or 3 soccer uniforms.	Quick Wash	Hot Warm Colors Cool	Ex. Heavy Heavy Normal Light	Max More Normal No Spin	Stain Removal Guide Deep Fill Warm Rinse Auto Soak Deep Rinse Delay Wash Extra Rinse Power Pre-Wash	Utilizes more intense profile and expedited period to clean small soiled loads in the fastest possible.
Wet load of items. For items that need only to be rinsed, use this cycle with Deep Rinse option.	Drain & Spin			Max More Normal No Spin	Deep Rinse Extra Rinse	Utilizes a high speed extract water from wet items. For items that need to be rinsed, select the Deep Rinse option when using this cycle.
Heavily soiled colorfast items.	Sanitize with Oxi*	Hot	Ex. Heavy	Max More	Warm Rinse Auto Soak Deep Rinse	Cycle uses an initial water fill for pre-soak, followed by concentrated, high temperature soak.



					Delay Wash Extra Rinse	followed by a heat step. A pump purge rinse is incorporated to remove contaminants. For additional details see the certifications below. Dispense not available for this cycle.
Jeans with medium to light soil. For heavily soiled work jeans, use the Heavy Duty Cycle.	Jeans	Hot Warm Colors Cool Cold Tap Cold	Ex. Heavy Heavy Normal Light	Max More Normal No Spin	Stain Removal Guide Deep Fill Warm Rinse Auto Soak Deep Rinse Delay Wash Extra Rinse Power Pre-Wash	Combines higher water level with a specially designed profile, and multi-step care for jeans with m light soil. Use the Hea cycle for heavily soiled jeans.
Sturdy fabrics with heavy to medium soil.	Deep Clean	Hot Warm Colors Cool Cold Tap Cold	Ex. Heavy Heavy Normal Light	Max More Normal No Spin	Stain Removal Guide Deep Fill Warm Rinse Auto Soak Deep Rinse Delay Wash Extra Rinse Power Pre-Wash	Incorporates multi-st periods combined extended wash pe effectively clean h medium soiled sturdy
Water-resistant, bedding and bulky items, such as large coats, mattress pads, and bath mats.	Bulky Items	Hot Warm Colors Cool Cold Tap Cold	Ex. Heavy Heavy Normal Light	Max More Normal No Spin	Stain Removal Guide Deep Fill Warm Rinse Auto Soak Deep Rinse Delay Wash	Provides a Deep F wash water level bulky and waterpro Also incorporates a rinse to effectively ri items and a low sp appropriate for the Only use this c



					Extra Rinse Power Pre-Wash	water-resistant, be bulky items.
Towels Sheets	Towels / Sheets	Hot Warm Colors Cool Cold Tap Cold	Ex. Heavy Heavy Normal Light	Max More Normal No Spin	Stain Removal Guide Deep Fill Warm Rinse Auto Soak Deep Rinse Delay Wash Extra Rinse Power Pre-Wash	Cycle designed towels or sheets, higher water le effectively clean the It is recommended th and sheets be separately for best washing performan waterproof bed co Bulky Items cycle.
Whites and household linens	Whites	Hot Warm Colors Cool Cold Tap Cold	Ex. Heavy Heavy Normal Light	Max More Normal No Spin	Stain Removal Guide Deep Fill Warm Rinse Auto Soak Deep Rinse Delay Wash Extra Rinse Power Pre-Wash	Cycle tailored to clea brighten your whites.

***Sanitize with Oxi:**

The Sanitize With Oxi cycle, when using an Oxi additive along with your detergent, is designed to remove 99.9% of bacteria found in home laundry. Measure the detergent and the Oxi products carefully. Using the amounts appropriate for a large heavily soiled load in a top load washer, follow the detergent and the Oxi product label instructions. For the Sanitize With Oxi cycle only, add the clothes first and then place the detergent and Oxi product directly on top of the load. The washer hot water supply connection must provide a minimum of 120°F to ensure the effectiveness of this cycle.

NOTE: The default Sanitize With Oxi cycle water temperature can NOT be changed.

The Sanitize With Oxi cycle is certified by NSF International, an independent third party testing and certification organization. The certification verified that the cycle reduced 99.9% of bacteria



typically found in residential laundry and that no significant contamination is transferred to subsequent washer loads. Only the Sanitize With Oxi cycle has been designed to meet the requirements of NSF Protocol P172 for sanitizing effectiveness.

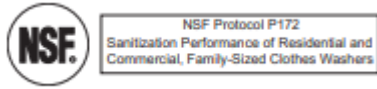

E. Pretreating or Soaking Using Water Station (on some models)

- This feature is for pretreating of garments only and not intended to serve as an actual wash cycle. When selected, the washer will supply either fresh water or water mixed with detergent from your SmartDispense system for garment hand pre-washing or pre-treating use.
- The pretreating water will be dispensed from the area located in the back of the main opening of the washer. When selected, any water dispensed into the wash tub during the pretreat will be drained from the machine before any subsequently selected wash cycle can begin.

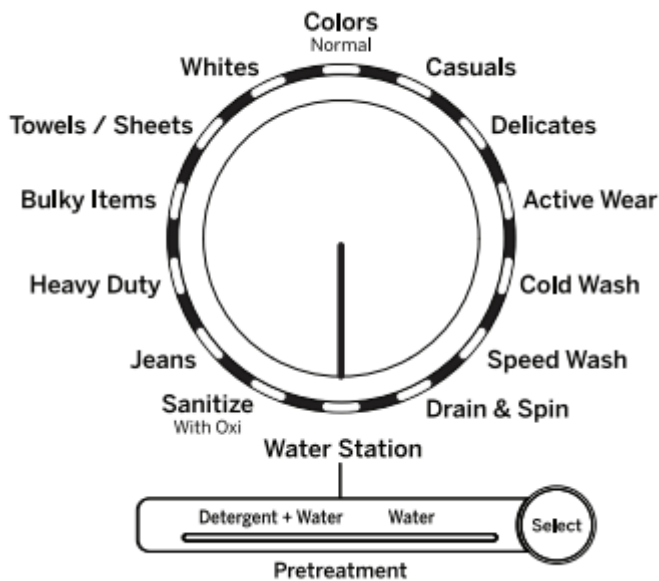

- Alternatively, you can use this feature to soak your garments in the pretreated water for up to 24 hours with the lid closed and the cycle knob remaining on Water Station.
- In order to use this feature to soak, keep dial on Water Station and close the lid. You can soak for up to 24 hours before the water in the tub will be automatically drained. Rotating the dial, holding the Start button for 3 seconds or leaving the lid open for more than 15 minutes will all automatically drain the water from the tub.

Water Station only



Select this feature:

1. Rotate the cycle selection knob to Water Station.
2. Push the Select button until the LED below Water is illuminated.
3. Select the desired water temperature using the Temp button.
4. Press the Start button to initiate the feature.

If the lid is not already open, raise the lid of the washer to start the flow of fresh water from the dispensing area. Water will continue to be dispensed until the lid is closed or the water level in the tub reaches the maximum level.

If the lid is closed before the maximum level in the tub is reached, additional water can be dispensed by opening the lid again. Once the lid is closed, water dispensed using the water on demand feature will remain in the tub until the cycle selection knob is rotated to an actual wash cycle, or the Start button is held in for 3 seconds, at which point the water in the tub will be drained out of the machine.

If the lid is not closed, the water in the tub will automatically be drained after 15 minutes. With the lid closed, if the cycle selection knob is not rotated to an actual wash cycle, or the Start button is not held in for 3 seconds, the water in the tub will automatically be drained after 24 hours.

Water Station with Detergent

Select this feature:

1. Rotating the cycle selection knob to the Water Station.
2. Push the Select button until the LED below Detergent + Water is illuminated.
3. Select the desired water temperature using the Temp button.
4. Press the Start button to initiate the detergent feature.

If the lid is not already open, raise the lid of the washer to start the flow of soapy water from the dispensing area. Soapy water will continue to be dispensed until the lid is closed or the water level in the tub reaches the maximum level.

If the lid is closed before the maximum level in the tub is reached, additional soapy water can be dispensed by simply opening the lid again. Once the lid is closed, soapy water dispensed will remain in the tub until the cycle selection knob is rotated to an actual wash cycle, or the Start button is held in for 3 seconds, at which point the soapy water in the tub will be drained out of the machine.

If the lid is not closed, the soapy water in the tub will automatically be drained after 15 minutes. With the lid closed, if the cycle selection knob is not rotated to an actual wash cycle, or the Start button is not held in for 3 seconds, the soapy water in the tub will automatically be drained after 24 hours.

F. Stain Removal Guide (on some models)

The Stain Removal Guide feature allows you to indicate what stains are on the garments in your load. An initial water fill is performed at a temperature tailored to the stain type selected and to an amount which enables a concentrated cleaning step. A stain scrubbing period, followed by an active soak, is conducted to effectively treat the stain. Then additional water is added to the selected temperature and the wash phase is conducted for the cycle selected.

This feature can be applied to most wash cycles as described in the cycle guide.

To use Stain Removal Guide:

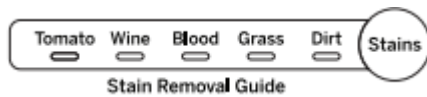

1. Select the desired wash cycle.
2. Press the Stain Removal Guide button.

Continue to press to select Tomato stain, Wine stain, Blood stain, Grass stain or Dirt stain. The indicator light will show the selected stain.

To select a different stain, press the Stain Removal Guide button until desired stain to be removed is lit.

To turn off Stain Removal Guide, press until no indicator lights are illuminated.

NOTE: The Soil and Temperature levels will be changed to match the recommended default setting for each stain type. Turning off Stain Removal Guide will return the settings to default.

Stain Removal Guide

Category	Recommended Temperatures Treatment/Wash	Stain	For best results, before placing in washer:
Blood	Cold/Cool	Blood Sweat Body Fluids Urine	Rinse in cold water; pretreat stain with liquid detergent or stain remover product.
Grass	Cold/Warm	Grass Lipstick Chocolate Gravy Mayonnaise BBQ Sauce	Pretreat with liquid detergent or stain remover product. Brush lightly; rinse with cold water.
Dirt	Cool/Warm	Dirt Clay Mud	Allow dirt to dry; remove loose dirt using a brush. Rinse with cool water.
Tomato	Cool/Warm	Sauce Catsup Salsa	Pretreat with liquid detergent or stain remover product; rinse with cool water.
Wine	Cool/Warm	Wine Soda Kool-Aid Tea Coffee Juice Beer	Pretreat with mixture of Oxi product and cool water. Add Oxi product along with detergent in the washer.

- Recommended temperatures are optimal for stain removal performance; adjust temperature selection to suit load being washed.
- Ensure stain is completely removed after wash cycle and before placing in dryer; very tough stains may require a second treatment.



G. Settings:

- Individual settings for agitation (Soil), water temperature (Temp), and spin (Spin) can be set from the minimum (lowest in column) to maximum (highest in column). In general, the higher up the column, the more washer energy will be used.

NOTE: Longer Spin times typically reduce dryer time/energy usage (i.e. reduces total energy when using both a washer and a dryer).

H. Cycle Options

- Deep Fill
 - Select the Deep Fill feature for loads where extra water is needed. The Deep Fill feature is recommended for special case loads only, not for typical use.
 - Press the Deep Fill button once before starting the cycle to add an incremental amount of water to the wash load. Holding the Deep Fill button for 3 seconds will provide the deepest fill level possible; this will increase cycle time due to the additional time it takes to fill the washer. To cancel the option if desired, press the Deep Fill button again.

NOTE: The Deep Fill button can also be pressed after the washer has completed filling and is in the wash phase if additional water is desired. To stop the extra fill, press the Deep Fill button again and the water will stop.

- Warm Rinse" Provides a warm rinse to your wash load. Note that rinsing operations may be different with this operation selected in order to effectively apply the warm rinse water to your load.
- Auto Soak: This option begins with a brief agitation, soaks for a specified period of time, then moves through the rest of the cycle automatically. Repeated pressing of the Soak button will scroll through 15 minute, 30 minute, 1 hour and 2 hour selections and then return back to 0 soak minutes.
- Deep Rinse: Set this option to provide a deep rinse or when using fabric softener. It may change other settings (e.g. Spin may go to a higher setting) to maximize performance.
- Delay Wash: When the Delay Wash button is repeatedly pressed, the delay time is set from 1 (01H) to 9 (09H) hours and back to clear (00H) hours. If you press and hold the Delay Wash button for 3 seconds, it will immediately reset.
- Extra Rinse: When you use extra detergent or bleach to clean heavily soiled clothes, use the Extra Rinse option to better remove additional residues. NOTE: This option is not allowed for some cycles.

I. Additional Options

- My Cycle Settings: As the cycle selector knob is turned, the Temp, Soil and Spin settings change to automatic pre-set default settings for each cycle. If you desire different default

settings, select the desired options or changes to the cycle settings, then press and hold the My Cycle button for 3 seconds to store them. The My Cycle button will light when active. In the future, when you turn the selector knob to that cycle, your settings will be automatically recalled. To restore the factory defaults temporarily (i.e. for this load), press the My Cycle button for 1/2 second. The My Cycle light will turn off and the factory defaults will load. However, the next time you select this cycle, your My Cycle settings will load. If you wish to permanently restore the factory default settings for the cycle; when the My Cycle is active (button light on) press and hold the My Cycle button for 3 seconds. The factory defaults will load for the selected cycle and the My Cycle light will turn off. The default settings will load when this cycle is selected in the future and the My Cycle light will remain off. NOTE: My Cycle saves the following options: Temp, Soil, Spin, Extra Rinse, Deep Fill, Warm Rinse, Auto Soak, Deep Rinse and Stain Removal Guide.

- Volume (on some models): Use the Volume button to change the volume of the end of cycle signal and other system tones. Press the button until you reach the desired volume (high, medium, low) or off.
 - Control Lock
 - Use the control lock before or during a cycle to prevent any selections from being made.
 - To lock/unlock the washer controls, press and hold the Warm Rinse and Auto Soak buttons for 3 seconds. The control lock icon will light up when it is on.
- NOTE: The Power button can still be used when the machine is locked.

J. SmartDispense™ (GTW840 and GTW845 models only)

- When selected, this feature will automatically add detergent to the wash, eliminating the need to add detergent for each load.
- The detergent amount selection on the control panel will default to AUTO when first powering up the washing machine. When AUTO is selected, the amount of detergent needed for each laundry load will automatically be determined based on the size of the load the machine senses.

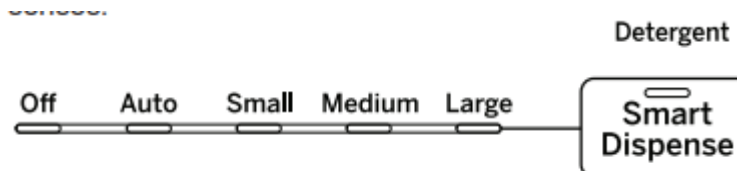

- This model does not have a dispenser drawer for detergent since it has a bulk detergent dispensing system.

NOTE: If it is desired to manually add detergent for a load, that detergent will need to be added directly to the basket, and the smart dispense set to OFF for that particular load.

NOTE: The right side of the dispensing area in the rear of the washer opening does NOT pull out. It is a spout only for water and detergent to flow from the smart dispense system

- If it is desired to manually select the amount of detergent for a given load, this can be done by pressing the Detergent Dispense button on the control panel to select detergent for a Small, Normal or Large load. Small will provide less detergent than average, Normal will provide an average amount of detergent and Large will provide more detergent than average.
- The smart dispense feature can be disabled by pressing the Detergent Dispense button until Off is selected.

NOTE: Not all cycles will allow the use of the SmartDispense feature. If the light is illuminated below the Off position and pressing the Detergent Dispense button results in a beeping tone, then SmartDispense is not allowed for the cycle that has been selected. Detergent will need to be added directly to the wash basket for these cycles.

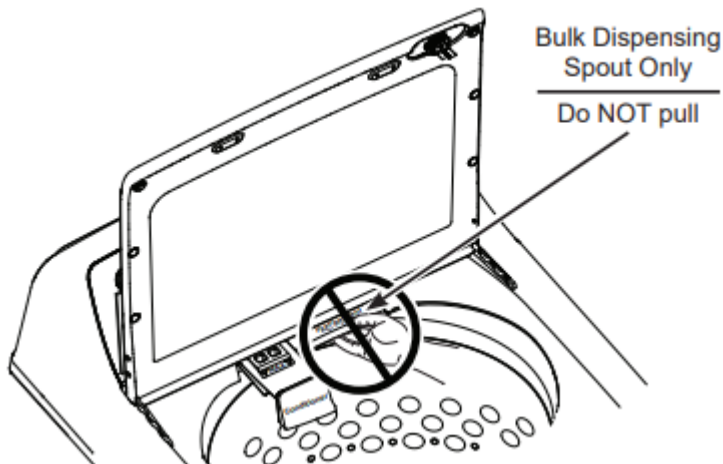

Adding Detergent to SmartDispenser™ (GTW750 and GTW755 models only)

- This machine is equipped with a bulk detergent reservoir that can hold approximately 75 ounces of liquid detergent for your convenience. This is enough detergent for about 50 average laundry loads, depending on what dispense amount is selected.



- The filling port of the detergent reservoir is located on the front left of the washing machine. To fill the reservoir with liquid detergent, first open the tank lid by rotating the small lid clockwise. Then pour LIQUID detergent into the opening until the level reaches the MAX indicator located inside the filling port, also indicated with the horizontal line next to the MAX lettering. Filling to this MAX level will provide detergent for about 50 average laundry loads. To ensure detergent is always available, liquid detergent should be added to the reservoir whenever there is no longer detergent visible when looking directly into the filling port.

NOTE: If it is desired to change detergent type in the detergent tank, it is not required to flush the smart dispense system. The new detergent type can be added to a partiallyfilled tank, however it will not be immediately dispensed until the original detergent is completely dispensed from the system.

NOTE: In the event that excessive chlorine bleach is accidentally spilled or otherwise gets into the detergent tank, please follow the Detergent Tank Clean-Out instructions in the Care and Cleaning section in order to minimize the possibility for clothing damage. If only a few drops of bleach are spilled into the detergent tank, there is no need to flush the tank.

Liquid Fabric Softener/Conditioner Dispenser (GTW750 and GTW755 models only)

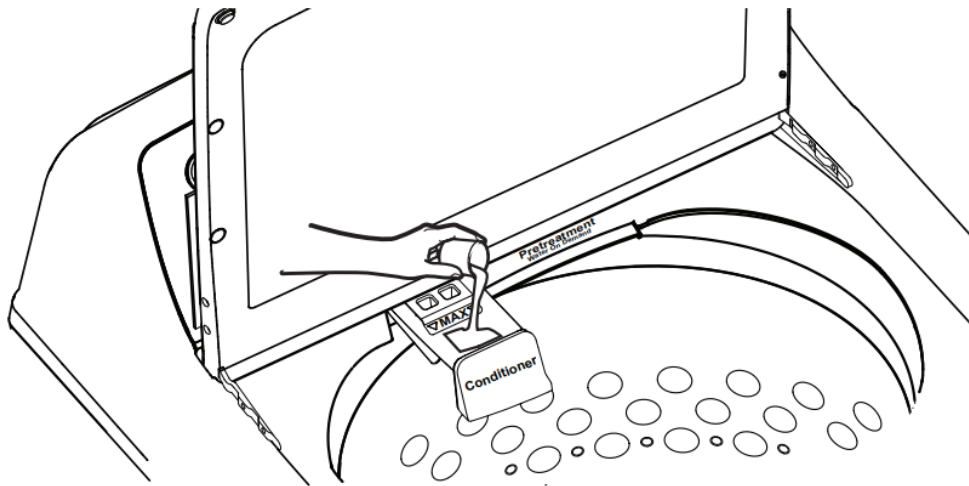

Liquid fabric softener/conditioner should be added to the small drawer in the rear of the washer opening. Follow the liquid fabric softener/conditioner manufacturer's recommendations for the correct amount of softener/conditioner, based on the load size. Do not overfill or dilute softener/conditioner as this can result in additive being dispensed prematurely in the wash cycle. Your option selections will determine when liquid fabric softener/conditioner is automatically dispensed at its optimal time in the rinse cycle.

NOTE: Fabric softener crystals should NOT be added to the dispenser drawer, as they will not dispense properly

Liquid Bleach (GTW750 and GTW755 models only)



- Use a measuring cup to pour the bleach into the bleach dispenser. Measure liquid bleach carefully and DO NOT pour directly from the bleach bottle into the bleach dispenser.

NOTE: The bleach dispenser is a single use dispenser and is NOT a bulk dispense system. The maximum amount of bleach that should be poured into this dispenser for any load should never exceed 1 cup.

NOTE: In the event that excessive chlorine bleach is accidentally spilled or otherwise gets into the detergent tank, please follow the Detergent Tank Clean-Out instructions in the Care and Cleaning section in order to minimize the possibility for clothing damage. If only a few drops of bleach are spilled into the detergent tank, there is no need to flush the tank.

NOTE: In the event that detergent is accidentally spilled or otherwise gets into the bleach opening, that detergent will simply be used for the next wash cycle. In this case there is no need to perform any flushing routine.

Detergent Dispenser (GTW680 and GTW685 models only)

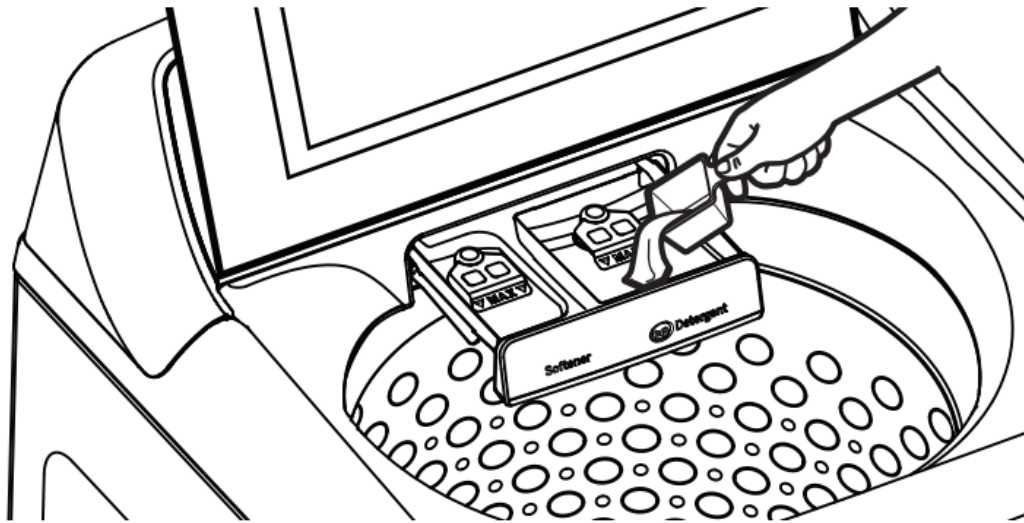

- HE detergent should be added to the right side of the dispenser drawer. Follow the detergent manufacturer's recommendations for the correct amount of detergent, based on load size, taking care to add detergent to the right compartment. Do not overfill or dilute detergent as this can result in additive being dispensed prematurely in the wash cycle. Your option selections will determine when detergent is automatically dispensed at its optimal time in the wash cycle. For optimal performance, especially when selecting cooler temperature and in cold weather climates, place powdered HE detergent directly in the wash basket before adding clothes.

NOTE: Single-dose laundry packets should not be added to the dispenser drawer, as they will not dispense properly. Put packets in bottom of wash basket.

Liquid Fabric Softener/Conditioner Dispenser (GTW680 and GTW685 models only)

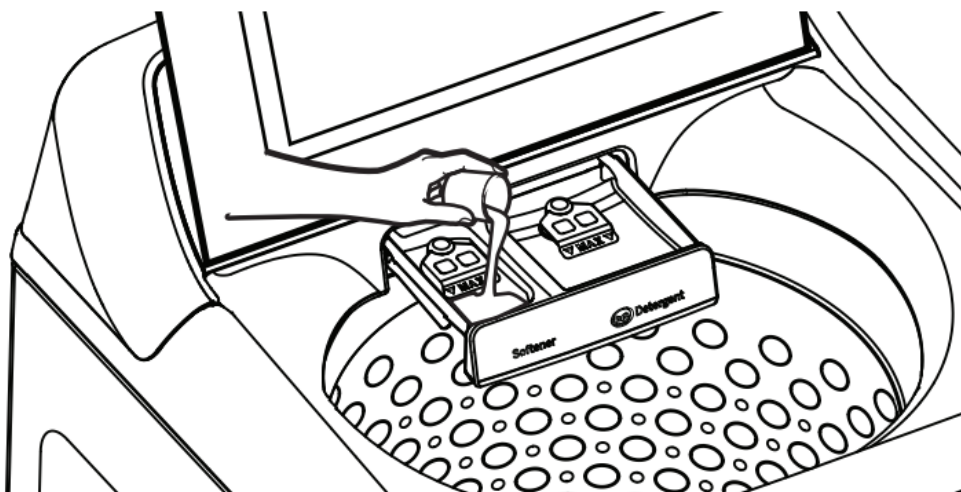

Liquid fabric softener/conditioner should be added to the left side of the dispenser drawer. Follow the liquid fabric softener/ conditioner manufacturer's recommendations for the correct amount of softener/conditioner, based on load size, taking care to add softener/conditioner to the left compartment. Do not overfill or dilute softener/conditioner as this can result in additive being dispensed prematurely in the wash cycle. Your option selections will determine when liquid fabric softener/conditioner is automatically dispensed at its optimal time in the rinse cycle.

NOTE: Fabric softener crystals should NOT be added to the dispenser drawer, as they will not dispense properly.

Liquid Bleach Dispenser (GTW680 and GTW685 models only)



- Liquid chlorine bleach should be added through the bleach dispenser in the front left corner. Follow bleach manufacturer's recommendations for the correct amount of liquid chlorine bleach based on load size, taking care to not apply or spill it directly on clothing.

NOTE: Do not use liquid chlorine bleach and laundry pretreatments such as an Oxi product in the same wash load.

Loading

Always follow fabric manufacturer's care label when laundering.

Automatic Load Sensing

- This determines the correct agitate profile, agitate duration and amount of water suited to the size and type of load placed in the washer. The washer will not start the wash cycle or fill with water if the lid is open. When the lid is closed the machine is able to begin filling with water in order to sense the load size.

NOTE: Automatic Load Sensing initiates a spin at the beginning of the cycle; this is normal operation.

NOTE: This is a high efficiency washing machine. This system requires less water while providing effective cleaning action. You may notice that the water level is lower than on your previous washer. This is normal for a high efficiency washer.

Pretreatment

- Place laundry pretreatments, such as an Oxi product, directly in the bottom of the wash basket before loading clothes.

NOTE: Do not use liquid chlorine bleach and laundry pretreatments such as an Oxi product in the same wash load.

Proper Use of Detergent

- Using too little or too much detergent is a common cause of laundry problems.
- Use less detergent if you have soft water, a smaller load or a lightly soiled load.
- For spots, apply pre-treatment to items as recommended on the product label. Application should be made in the basket to prevent overspray which may cause the coloring on the lid or graphics to fade.
- Place detergent packets in the Laundry Pack Dispenser (on some models) or the bottom of the wash basket before adding clothes.

- GE Appliances recommends the use of High Efficiency detergents such as  in your energy efficient washer. HE detergents are formulated to work with low water wash and rinse systems. HE detergents reduce the oversudsing problems commonly associated with regular detergents.

- When using high efficiency or concentrated detergents, consult the product label to determine amount required for optimum performance. Excessive detergent will negatively impact wash performance.

Sorting Wash Loads

- Sort by color (whites, lights, colors), soil level, fabric type (sturdy cottons, easy care, delicates) and whether the fabric produces lint (terry cloth, chenille) or collects lint (velveteen, corduroy). Wash lint producers such as cotton towels and socks separate from lint collectors including synthetic garments and dress pants.

Loading the Washer

Load dry items loosely in the washer basket. For best results, load items evenly and loosely around the outside of the basket, filling in towards the center on larger loads. To add items after washer has started, press Start/Pause if the lid is locked; wait until the Lid Lock indicator on the display is no longer illuminated before attempting to open the lid. Lift the lid and submerge

additional items around the outside of the basket. Close the lid and press Start to resume. Adjust load size selection and/or use Deep Fill option if necessary.

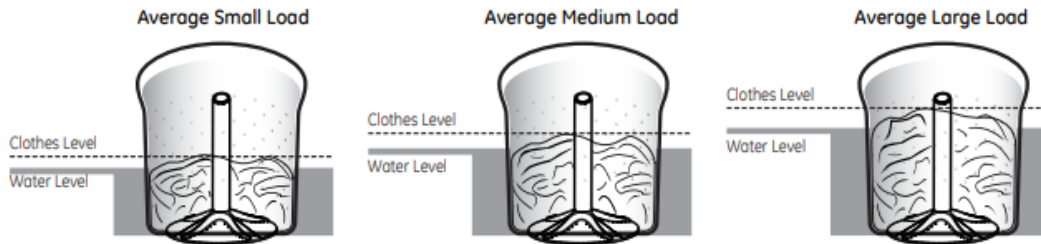

- Do not place large items such as sheets, blankets and towels across the Infusor. Load them around the outside of the basket.
- Do not put lawn or sofa cushions into the washer as they are too big to move. Remove outer covers and ONLY wash them.

Appliance communication

WiFi Connect (For customers in the United States only - on some models)

- Depending on the model, your washer is either GE Appliances WiFi Connect enabled, or compatible using the optional GE Appliances ConnectPlus module.
- If enabled: Visit geappliances.com/connect and enter your model number to show you the proper steps to connect your appliance.
- If compatible: To connect this appliance to the internet you will need to purchase a GE Appliances ConnectPlus and attach the module to your appliance through the communication port in the appliance. The GE Appliances ConnectPlus will allow your appliance to communicate with your smartphone for remote appliance monitoring, control and notifications.
- Please visit GEAppliances.com/connect to learn more about connected appliance features, to learn what connected appliance app's will work with your smartphone.
- WiFi Connectivity: For assistance with the appliance or the ConnectPlus network connectivity, please call GE Appliances at 800.GE.CARES.
- Visit your local authorized GE Appliances parts distributor or order by phone at 800.661.1616 during normal business hours.

Part Number	Accessory
PBX10W00Y0	WiFi ConnectPlus module

CARE AND CLEANING

WARNING - Electrical Shock Hazard: Certain internal parts are intentionally not grounded and may present a risk of electric shock only during servicing. Service personnel – DO NOT contact the following parts while the appliance is energized: Drive Motor, Lid Lock, Water Valves, Drain Pump and Recirculation Pump.

Exterior of the Washer

- Immediately wipe off any spills with a damp cloth.

Interior of the Washer

NOTE: For the GTW750 and GTW755 models, the following instructions should be followed using the Bulky Items cycle.

To clean the interior of the washer, select the Basket Clean feature on the control panel. This Basket Clean cycle should be performed, at a minimum, once per month. This cycle will use more water, in addition to bleach, to control the rate at which soils and detergents may accumulate in your washer.

NOTE: Read the instructions below completely before starting the Basket Clean cycle.

1. Remove any garments or objects from the washer and ensure the washer basket is empty.
2. Open the washer lid and pour one cup or 250 ml of liquid bleach or other washing machine cleaner into the basket.



3. Close the lid and select the Bulky Items cycle. Push the Start button.
4. When the Bulky Items cycle is working, the display will show the estimated cycle time remaining. Do not interrupt the cycle.

Basket Clean may be interrupted by pressing the Start button in between cycles. A power outage in the house might also interrupt the cycle. When the power supply is back, the Basket Clean cycle resumes where it had stopped. When interrupted, be sure to run a complete Basket Clean cycle before using the washer. If the Power button is pressed during Basket Clean, the cycle will be lost.

IMPORTANT:

- Run Basket Clean with 1 Cup (250 ml) of bleach once a month.
- After the completion of a Basket Clean cycle, the interior of your washer may have a bleach smell.

Dispenser Drawer

- After some period of use, a small amount of detergent or softener residue may be present in the dispenser drawer. The drawer can easily be removed for cleaning. To remove the drawer, pull it out until the drawer stops and then lift up on the front of the drawer. The drawer can then be removed from the dispenser box. Wash the drawer in warm, soapy water using a mild detergent. Rinse drawer with warm water. If siphon caps are removed for cleaning, be sure to push siphon caps fully back into place after cleaning.
- The dispenser drawer and siphon caps are not dishwasher safe. The dispenser box is not removable, but it can be wiped clean using a damp cloth if necessary. Do not attempt to remove the dispenser box for cleaning.



GTW680 and GTW685 models have a large dispenser drawer with compartments for both detergent and softener.

Detergent Tank Clean-Out (GTW750 and GTW755 models only))

NOTE: All clothes should be removed from the washer prior to cleaning out the detergent tank.

To empty out the tank and remove any remaining detergent from the reservoir:

1. Press and hold both the Detergent Dispense and Select buttons for three seconds.
2. The empty out routine will begin with the contents of tank, mixed with water, being dispensed into the basket and consequently drained from the machine at the same time.
3. The empty out routine will continue for approximately 15 minutes unless it is paused by the pressing of the Start button. If tank is initially full, routine may need to be run a second time to empty detergent tank

NOTE: Optionally, hot water can be added to the tank to aid in flushing out the system of any residual detergent prior to starting or during the cleanout routine.

Water Supply Hoses

- Hoses connecting washer to faucet should be replaced every 5 years.

Long Vacations



- Be sure water supply is shut off at faucets. Drain all water from hoses and water filter pump area if weather will be below freezing.

Moving and Storage

- Ask the service technician to remove water from drain pump and hoses. Do not store the washer where it will be exposed to the weather.
- GTW750 & GTW755 models only: Do not move the washer with a full tank of detergent. If moving the washer with a partially filled tank of detergent, do not tilt washer forward as detergent could spill from tank. If moving the washer will result in tipping the washer forward in any way, it is best to flush out your detergent tank. See Detergent Tank Clean-Out in this Care and Cleaning section..

Troubleshooting Tips

... Before you call for service

Problem	Possible Causes	What To Do
Small amount of water remaining in dispenser (on some models) at end of cycle	Normal dispenser operation	It is normal for a small amount of water to remain in dispenser after the cycle.
Short spray and delay after pushing the Start button	Lid was opened and closed between cycle selection and start	This is normal. See START-UP SEQUENCE in the Instructions section.
Water level seems low	This is normal	Water may not cover the top level of the clothes. This is normal for this high efficiency washer.
Low water flow	Water valve screens are stopped up	Turn off the water source and remove the water connections from the upper back of the washer and the water faucet. Clean both the hose screens (if so equipped) and the screens inside the machine using a brush or a toothpick. Reconnect the hoses and turn the water back on. Check to ensure there are no leaks at all connections.
Water siphoning out of washer	Drain standpipe is too low or hose too far into standpipe	The drain hose must exceed 30" height at some point between the washer back and the drain pipe. Use anti-siphon clips. See Installation Instructions .
Too many suds	Soft water	Try less detergent.
	Too much detergent	Measure your detergent carefully. Use less soap if you have soft water, a smaller load or a lightly soiled load.
	Type of detergent	Switch to High Efficiency detergent such as 
Water leaks	Type of detergent	Switch to High Efficiency detergent such as 
	Using too much detergent in washer	Use less detergent. Use less soap if you have soft water, a smaller load or a lightly soiled load.
	Fill hoses or drain hose is improperly connected	Make sure hose connections are tight at faucets and rubber washers are installed. Make sure end of drain hose is correctly inserted in and secured to drain facility.
	Household drain clogged	Check household plumbing. You may need to call a plumber.
	Drain hose rubs on wall	Make sure drain hose does not make contact with the wall to cause excessive wear on the hose.

	Constant water pressure to fill hoses at water source	Tighten hoses at the faucets. Check condition of the fill hoses; they should be replaced every 5 years.
Water temperature seems incorrect	Cooler water temperatures provide improved energy efficiency	New laundry detergents have been formulated to work with lower water temperatures without affecting wash performance.
	Water supply is turned off or improperly connected	Turn both hot and cold faucets fully on and make sure hoses are properly connected to correct faucets. NOTE: Water valves are marked with "H" and "C".
	Water valve screens are stopped up	Turn off the water source and remove the water connections from the upper back of the washer and the water faucets. Remove both the hose screens (if so equipped) and the screens from the machine using a brush or a toothpick. Reconnect the hoses and turn the water back on. Check to ensure there are no leaks at all connections.
	Cool/Cold Water when selecting Hot	This is normal. The washer senses water temperature (on certain models) and optimizes for best results. Cold water is added periodically when hot is selected.
	House water heater is not set properly	Make sure house water heater is delivering water at 120°F (48°C–60°C).
Water pumped out before cycle is complete	Water was left in unit for 24 hours with lid closed or 15 minutes with lid open	Previous cycle has been cancelled. Close lid, select new cycle, and start machine.
Water won't drain	Drain hose is kinked or improperly connected	Straighten drain hose and make sure washer is not sitting on it. Top of drain outlet should be less than 8 ft (2.44 m) above floor.
Washer spins and pauses at the beginning of cycles	This is normal	The washer is sensing the load.
Washer pauses during wash cycle	The Soak Option was chosen	This is normal. The washer alternates between agitate and soak during these cycles to get your clothes cleaner with less detergent.
	This is normal	Many cycles incorporate a series of soaks within the agitate period to get your clothes clean with less wear.
Residual powder in dispenser or		Select a warmer wash temperature if possible to improve dissolving of detergent or use liquid detergent. Make sure



clogging of dispensers	Wash water too cold or low home water pressure	caps are free of debris and fully pressed into position. Rinse and clean tray if clogging occurs.
Laundry additives dispensing too soon	Overfilling of dispensers	Do not overfill or add water to dispenser. Select Deep Rinse option when using fabric softener.
Washer pauses during spin cycle	This is normal	The washer may pause during the spin cycle to remove water more efficiently.
Washer won't operate	Washer is unplugged	Make sure cord is plugged securely into a working outlet.
	Water supply is turned off	Turn both hot and cold faucets fully on.
	Lid is open—safety feature prevents agitation and spinning when lid is up	Close lid and press Start .
	Circuit breaker/fuse is tripped/blown	Check house circuit breakers/fuses. Replace fuses or reset breaker. Washer should have a separate outlet.
	Electronics need to be reset	Unplug washer, wait 2 minutes, plug back in and press Start .
	Start was not pressed	Press Start .
Detergent packet not dissolving	Laundry detergent packet placed in dispenser	Laundry detergent packets should not be used in the dispenser. They should only be added directly to the wash basket following the manufacturer's directions.
Unexplained time and/ or settings changes	Changing options (on some models)	This is normal. Several options will change other options to maximize washer performance.
Basket seems loose	Basket moves or rotates freely	Washer basket does not have a traditional brake. Washer basket will move freely. This is normal.
Colored spots	Incorrect use of fabric softener	Check fabric softener package for instructions and follow directions for using dispenser. Make sure you have selected the Deep Rinse option. Pretreat stain and rewash using Speed Wash cycle before drying.
	Dye transfer	Sort whites or lightly colored items from dark colors.
Grayed or yellowed clothes	Detergent amount	Be sure to follow detergent manufacturer's directions.
	Hard water	Use a water conditioner or install a water softener.



	Water is not hot enough	Make sure water heater is delivering water at 120°F–140°F (48°C–60°C).
	Washer is overloaded	Loosely load clothes no higher than the top row of holes in the washer basket. For best results, load items around the outside of the basket.
	Dye transfer	Sort clothes by color. If fabric label states wash separately, unstable dyes may be indicated.
Lint or residue on clothes	Clothes are air or line dried	If you do not dry your clothes with a clothes dryer, your clothes may retain more lint.
	Incorrect sorting	Separate lint producers from lint collectors.
	Washing too long	Wash small loads for a shorter time using Light Soil setting.
	Detergent not dissolving	Rewash, next time: Try a liquid detergent; Use warmer water temperature.
	Overloading	Loosely load clothes in the washer basket. For best results, load items around the outside of the basket.
	Incorrect use of fabric softener	Check fabric softener package for instructions and follow the directions for using dispenser. Make sure you have selected the Deep Rinse option.
Clothes too wet	No spin selected	Select a spin option.
	Incorrect cycle selected	Make sure the cycle selected matches the load you are washing. Some fabrics will feel wetter when rinsed with cold water.
	Wash load out of balance	Redistribute load in washer and run through Drain & Spin cycle.
Blinking Spin light or Spin light on at end of cycle	Out of balance condition has been detected	Allow cycle to continue and finish. If load is wet at the end of the cycle, even out load and run through Drain & Spin cycle.
Pilling	Result of normal wear on poly-cotton blends and fuzzy fabrics	While this is not caused by the washer, you can slow the pilling process by washing garments inside out.
Snags, holes, tears, rips or excessive wear	Pins, snaps, hooks, sharp buttons, belt buckles, zippers and sharp objects left in pockets	Fasten snaps, hooks, buttons and zippers. Remove loose items like pins, objects in pockets and sharp buttons. Turn knits (which snag easily) inside out.



	Undiluted chlorine bleach	Check bleach package instructions for proper amount. Never add undiluted bleach to wash or allow clothes to contact with undiluted bleach.
	Chemicals like hair bleach or dye, permanent wave solution	Rinse items that may have chemicals on them before wash. Use Speed Wash cycle with Extra Rinse option.
Wrinkling	Incorrect wash and dry cycles	Match Cycle selection to the type of fabric you are washing (especially for easy care loads).
	Improper sorting	Avoid mixing heavy items (like jeans) with light items (like blouses). Try a fabric softener.
	Overloading	Loosely load clothes in the washer basket.
	Repeated washing in water that is too hot	Wash in warm or cold water.



Sounds	Possible Causes	Reason
“Clicking”	Shifter mechanism is engaging or disengaging	The drive system will engage at the start of agitate and disengage when agitate is complete. This occurs multiple times during the wash.
Back and forth “swoosh”	Electric motor reversing direction	This sound is the motor rotating back and forth to clean laundry.
“Clicking” behind Control during fill	Automatic Temperature Control Valve	Two valves mix cold and hot water. The “clicking” is when either valve turns on or off to raise or lower the fill water temperature.
Water flow changes during fill	Automatic Temperature Control Valve	Two valves mix cold and hot water. The “clicking” is when either valve turns on or off to raise or lower the fill water temperature.
Motor sounds during spin	Motor ramping up/down during spin cycle	The motor will speed up incrementally during the spin cycle. When spin is complete, it will coast until it stops.
“Humming”	Water drain pump	The drain pump will make a humming sound when pumping out water after agitation stops and continue until spin is complete.
	Drive motor	The drive motor will make a “humming” sound during the wash and spin phases of the cycle.
“Gurgling”	Water drain pump	When the pump starts drawing in air, it starts to gurgle. The washer should then begin spinning and the sound will continue until it is done spinning.
Water “swishing”	Washing process	Water swishing while the unit is agitating is normal, especially with smaller loads.
Washer rocking/moving	Washer leveling legs uneven	To level the washer, adjust the leveling legs by rotating the individual leg in the proper direction for up or down.
“Squeaking” sound	Washer not level and rubbing on cabinet	To level the washer, adjust the leveling legs by rotating the individual leg in the proper direction for up or down.

Warning

This content is compiled from multiple sources and is provided for reference purposes only. It may not be complete or fully applicable to all situations. If you are unable to resolve your issue, please contact the product manufacturer or an authorized service provider for official support.

