

Owner's Manual Refrigerator

Operating Instructions

About the controls with temperature settings.

Not all features are on all models. Your controls will look like one of the following:



Location of Dispenser Controls

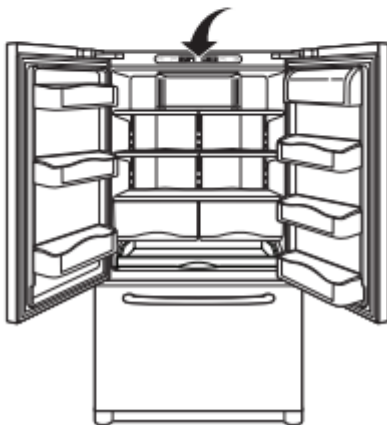

Location of Internal Controls

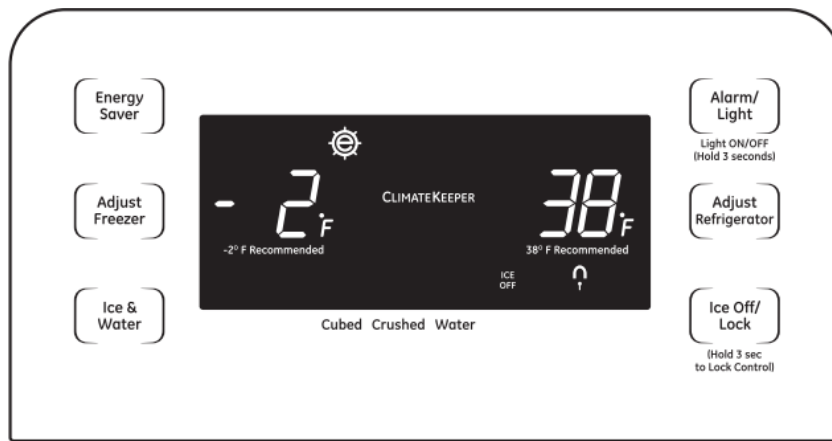

Dispenser Models



Internal Control Models

NOTE: The refrigerator is shipped with protective film covering the temperature controls. If this film was not removed during installation, remove it now

The temperature controls are preset in the factory at 38°F for the refrigerator compartment and -2°F for the freezer compartment. Allow 24 hours for the temperature to stabilize to the preset recommended settings.

The temperature controls can display both the SET temperature as well as the actual temperature in the refrigerator and freezer. The actual temperature may vary slightly from the SET temperature based on usage and operating environment.

Changing the Temperature

Dispenser models:



- To change the temperature, press and release the Adjust Freezer or Adjust Refrigerator pad. The display will show the actual temperature. Tap either the Adjust Freezer or Adjust Refrigerator pad until the desired temperature is displayed.
- Once the desired temperature has been set, the temperature display will return to the actual refrigerator and freezer temperatures after 10 seconds. Several adjustments may be required.



- Each time you adjust controls, allow 24 hours for the refrigerator to reach the temperature you have set.

Internal control models:



- To change the temperature, press and release the Freezer or Fridge pad. The display will show the actual temperature. Tap either the Freezer or Fridge pad until the desired temperature is displayed.
- Once the desired temperature has been set, the temperature display will return to the actual refrigerator and freezer temperatures after 10 seconds. Several adjustments may be required.
- Each time you adjust controls, allow 24 hours for the refrigerator to reach the temperature you have set.



About the controls.

To Use the Dispenser (on some models)



Spill Shelf



- Select Cubed Ice , Crushed Ice  or Water  by pressing the Ice & Water pad.
- Press the glass gently against the top of the dispenser cradle.
- The spill shelf is not self-draining. To reduce water spotting, the shelf should be cleaned regularly.
- If no water is dispensed when the refrigerator is first installed, there may be air in the water line system. Press the dispenser arm for at least two minutes to remove trapped

air from the water line and to fill the water system. To flush out impurities in the water line, throw away the first six full glasses of water.

CAUTION: Never put fingers or any other objects into the ice crusher discharge opening.

To Lock and Unlock the Dispenser (on some models)



- To lock, press and hold the Ice Off/Lock pad for 3 seconds. Repeat this step to unlock the dispenser

Internal Water Dispenser (on some models)

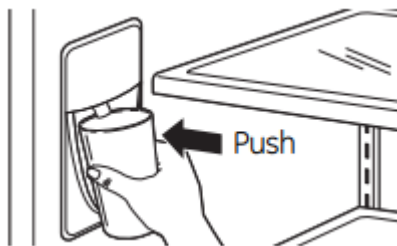

- To use the internal water dispenser, place a glass underneath the water outlet and push gently against the dispenser with your glass.

Important Facts About Your Dispenser

- Do not add ice from trays or bags to the storage drawer. It may not crush or dispense well.
- Avoid overfilling glass with ice and use of narrow glasses. Backed-up ice can jam the chute or cause the door in the chute to freeze shut. If ice is blocking the chute, poke it through with a wooden spoon.
- Beverages and foods should not be quick-chilled in the ice storage drawer. Cans, bottles or food packages in the storage drawer may cause the icemaker or auger to jam.
- To keep dispensed ice from missing the glass, put the glass close to, but not touching, the dispenser opening.
- Some crushed ice may be dispensed even though you selected Cubed Ice. This happens occasionally when a few cubes accidentally get directed to the crusher.
- After crushed ice is dispensed, some water may drip from the chute.

- Sometimes a small mound of snow will form on the door in the ice chute. This condition is normal and usually occurs when you have dispensed crushed ice repeatedly. The snow will eventually evaporate.

About Door Alarm (on some models)



- The door alarm will sound if any door is open for more than 3 minutes. The beeping stops when you close the door.

About Dispenser Light (on some models)

- Press and hold the Alarm/Light pad for 3 seconds to turn on the dispenser light. To turn off, press and hold the pad again for 3 seconds.

About Energy Saver



- This product is equipped with an Energy Saver feature. The refrigerator is shipped with the Energy Saver feature on.
- Over time, moisture can form on the front surface of the refrigerator cabinet and cause rust. If moisture does appear on the front surface of the refrigerator cabinet, turn off the Energy Saver feature by pressing and releasing the Energy Saver pad on the control panel.

About the water filter

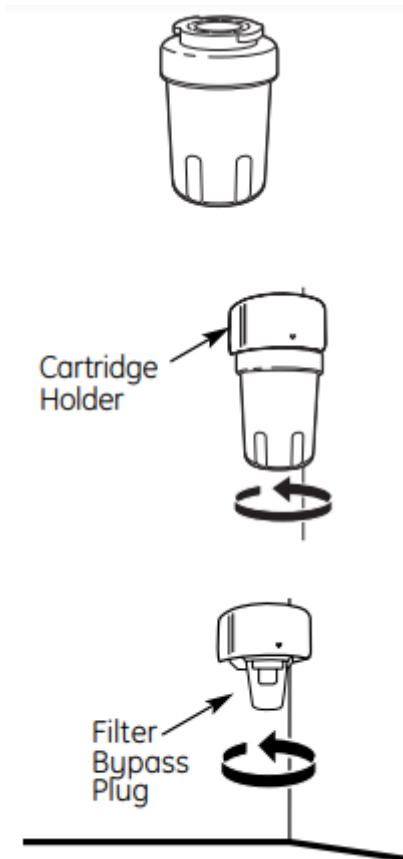

Water Filter Cartridge

- The water filter cartridge is located in the back upper right corner of the refrigerator compartment.

When to Replace the Filter

- The filter cartridge should be replaced every six months or if the flow of water to the dispenser or icemaker decreases.

Installing the Filter Cartridge

1. If you are replacing the cartridge, first remove the old one by slowly turning it counterclockwise. A small amount of water may drip down.
2. Remove the protective foil from the end of the cartridge.
3. Lining up the arrow on the cartridge and the cartridge holder, place the top of the new cartridge up inside the holder. Do not push it up into the holder. Slowly rotate the cartridge clockwise until it stops. As you turn the cartridge, it will automatically raise itself into position. Cartridge will rotate about 1/4 turn. Do not overtighten.
4. Run water from the dispenser for 3 minutes (about 1 1/2 gallons) to clear the system and prevent sputtering. See To Use the Dispenser section.

About fresh food storage options.

Rearranging the Shelves

Shelves in the refrigerator compartment are adjustable.

To remove:

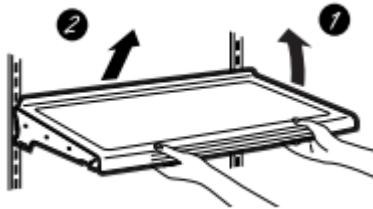

1. Remove all items from the shelf.
2. Tilt the shelf up at the front.
3. Lift the shelf up at the back and bring the shelf out.

To replace:

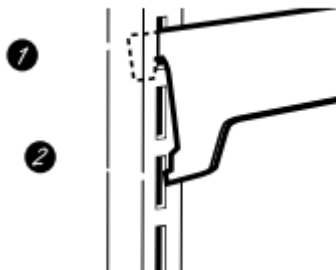

1. While tilting the shelf up, insert the top hook at the back of the shelf in a slot on the track.
2. Lower the front of the shelf until the bottom of the shelf locks into place.

Spillproof Shelves

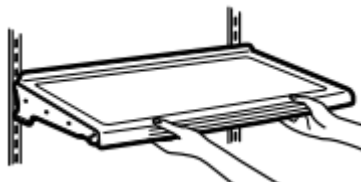

- Spillproof shelves have special edges to help prevent spills from dripping to lower shelves.

Floating snack pan

The location of the snack pan is adjustable and can be changed like the other shelves.

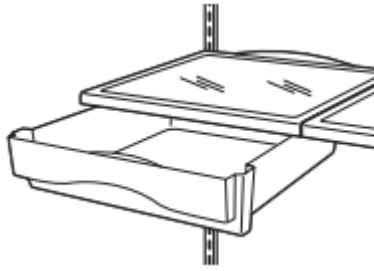

To remove:

1. Pull the snack pan out to the stop position.
2. Lift the pan up and past the stop

Non-Adjustable Dairy Bin

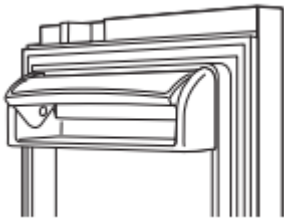

- To remove: Lift the dairy bin straight up, then pull out.
- To replace: Engage the bin in the molded door supports and push down. The bin will lock in place.

Adjustable Bins on the Door

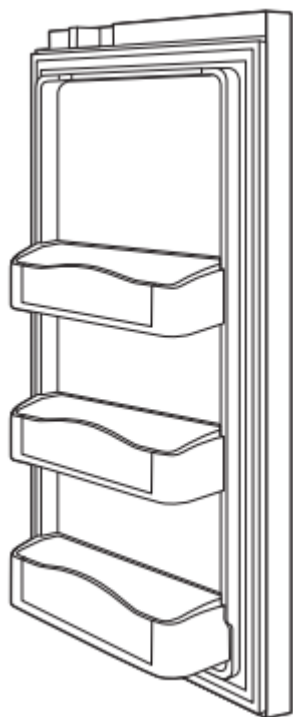

- Adjustable bins can easily be carried from refrigerator to work area.
- To remove: Lift bin straight up, then pull out.
- To replace or relocate: Slide in the bin just above the molded door supports, and push down. The bin will lock in place.

NOTE: On models without a full-width pantry, the location of the bottom door bin is not adjustable.

Non-Adjustable Bins on the Door (on some models)

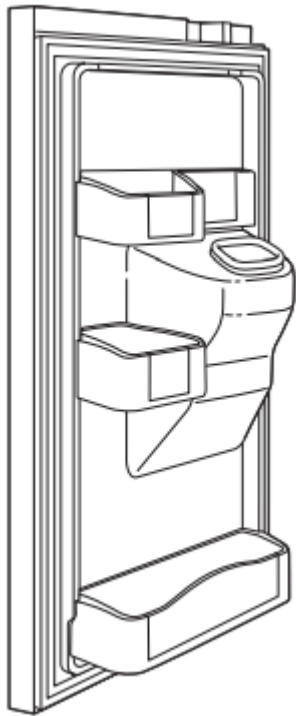

- To remove: Lift the bin straight up, then pull out.
- To replace: Engage the bin in the molded supports on the door and push down. It will lock in place.

Fruit and Vegetable Crisper

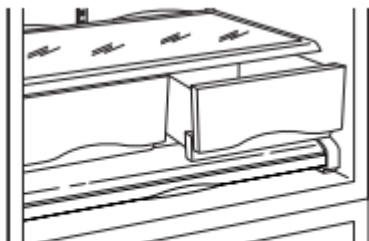

- Keep fruits and vegetables organized in separate compartments for easy access.
- Excess water that may accumulate in the bottom of the drawers or under the drawers should be wiped dry

Adjustable Deli/Produce Drawer (on some models)

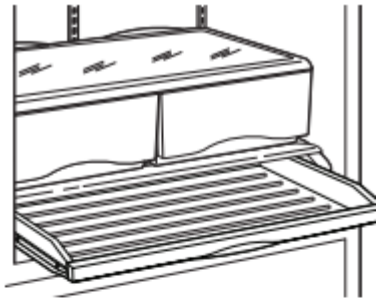

The control is located on the right side of the drawer.

- The Adjustable Deli/Produce Drawer is a full-width drawer with adjustable temperature control. This drawer can be used for large miscellaneous items.
- There is a temperature control which can adjust the amount of cold air allowed into the drawer.

Control

- When Produce Drawer is selected, the temperature of the drawer can be kept around 38°F (3°C). This feature also helps keep food fresh for a long time.
- When Deli Drawer is selected, the temperature of the drawer can be kept around 34°F (1°C). This feature also helps keep meat or fish fresh for a longer time.

NOTE: Fruits and vegetables may be damaged using the Deli Drawer setting. Do not store lettuce or other leafy produce in this drawer.

CAUTION: Do not store glass bottles in this drawer. If they are frozen, they can break and cause personal injury

How to Remove and Replace the Adjustable Deli/Produce Drawer

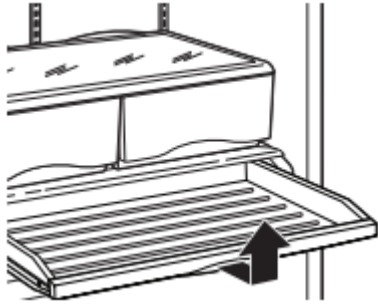

To remove:

1. Pull the drawer out to the stop position.
2. Lift the front of the drawer up and out.

To replace:

1. Lift the cover up.
2. Engage the pantry rollers into the side rails.
3. Push the drawer inward (until it is in place).

How to Remove and Replace Drawer Divider

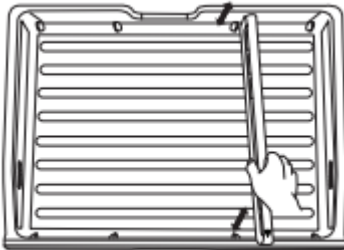

To remove:

1. Pull the drawer out to the stop position.
2. Raise the front side of the divider to unhook it from the rear wall of the drawer

To replace:

1. Hook the back of the divider over the rear wall of the drawer.
2. Push the divider down.

About the freezer.

Freezer Basket and Drawer

1. Basket.
2. Drawer.

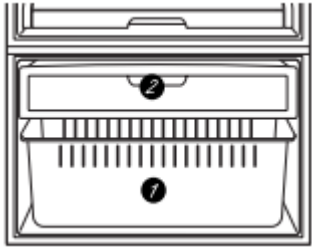

Basket Removal

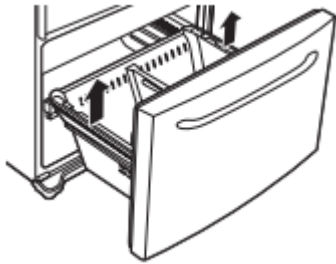

To remove:

1. Remove Freezer Bin. (See below.)
2. Pull basket out to the stop position.
3. Tilt up the rear of the bin.
4. Lift it out to remove.

To replace:

1. Place the basket into the rail assembly

Basket Divider Removal

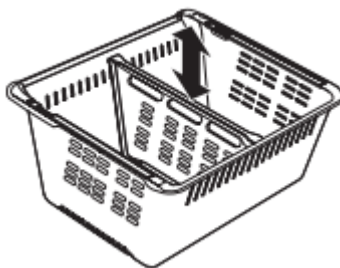

To remove:

1. Pull basket out to the stop position.
2. Tilt up the rear of the bin.
3. Lift it out to remove.

To replace:

1. Hook the top corners of the divider over the hole of the basket.

Drawer Removal

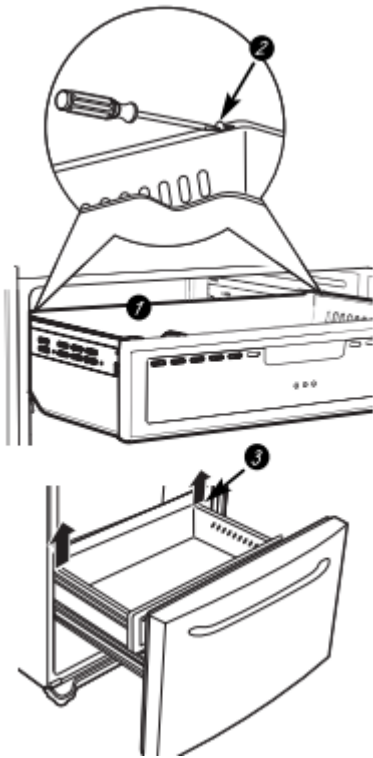

To remove:

1. Pull the drawer out to the stop position.
2. Remove both side knobs with a flat-head screwdriver (as shown at left).
3. Tilt up the rear of the drawer and lift drawer up and out.

To replace:

1. Pull both rails out to the stop position.
2. Place the drawer onto the rails and hook the support into the slots located on the side of the drawer.
3. Replace the side knobs and push the drawer back into place.

WARNING: Do not lose the side knobs during disassembly since they may present a choking hazard to children.

Non-Adjustable Bin in the Freezer

- To remove: Pull the brackets upward until you hear a clicking sound and remove the bin.
- To replace: Hook the ends of the bin into both brackets and push down until the bin locks into place.

About the automatic icemaker

A newly installed refrigerator may take 12 to 24 hours to begin making ice.

Automatic Icemaker

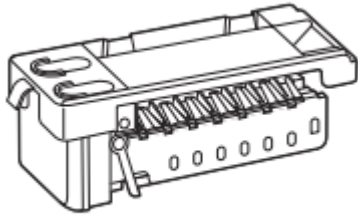

- The icemaker will produce seven cubes per cycle—approximately 100–130 cubes in a 24-hour period, depending on freezer compartment temperature, room temperature, number of door openings and other use conditions.
- If the refrigerator is operated before the water connection is made to the icemaker, press and release the Ice Off/Lock or Ice Off pad on the control panel to disengage the icemaker.
- When the refrigerator has been connected to the water supply, press and release the Ice Off/Lock or Ice Off pad on the control panel to engage the icemaker.
- A newly installed refrigerator may take 12 to 24 hours to begin making ice cubes.
- You will hear a buzzing sound each time the icemaker fills with water.
- Throw away the first few batches of ice to allow the water line to clear.
- Be sure nothing interferes with the sweep of the feeler arm.
- When the bin fills to the level of the feeler arm, the icemaker will stop producing ice. It is normal for several cubes to be joined together.
- If ice is not used frequently, old ice cubes will become cloudy, taste stale and shrink.

NOTE: In homes with lower-than-average water pressure, you may hear the icemaker cycle multiple times when making one batch of ice.

NOTE: Turn on the Ice Off feature if the water supply is shut off

Care and cleaning of the refrigerator

Cleaning the Outside

- The door handles and trim. Clean with a cloth dampened with soapy water. Dry with a soft cloth. Do not use wax on the door handles and trim.
- Keep the outside clean. Wipe with a clean cloth lightly dampened with kitchen appliance wax or mild liquid dish detergent. Dry and polish with a clean, soft cloth.
- Do not wipe the refrigerator with a soiled dish cloth or wet towel. These may leave a residue that can erode the paint. Do not use scouring pads, powdered cleaners, bleach or cleaners containing bleach because these products can scratch and weaken the paint finish.
- The stainless steel panels and door handles. Stainless steel (on some models) can be cleaned with a commercially available stainless steel cleaner. A spray-on stainless steel cleaner works best.
- Do not use appliance wax or polish on the stainless steel.
- Silver-accented plastic parts. Wash parts with soap or other mild detergents. Wipe clean with a sponge, damp cloth or paper towel.
- Do not scrub with steel-wool pads or other abrasive cleaners.

Cleaning the Inside

- To help prevent odors, leave an open box of baking soda in the refrigerator and freezer compartments.
- Unplug the refrigerator before cleaning. If this is not practical, wring excess moisture out of sponge or cloth when cleaning around switches, lights or controls.
- Use an appliance wax polish on the inside surface between the doors.
- Use warm water and baking soda solution— about a tablespoon (15 ml) of baking soda to a quart (1 liter) of water. This both cleans and neutralizes odors. Rinse and wipe dry.
- After cleaning the door gaskets, apply a thin layer of petroleum jelly to the door gaskets at the hinge side. This helps keep the gaskets from sticking and bending out of shape.
- Avoid cleaning cold glass shelves with hot water because the extreme temperature difference may cause them to break. Handle glass shelves carefully. Bumping tempered glass can cause it to shatter.
- Do not wash any plastic refrigerator parts in the dishwasher.
- Silver-accented plastic parts. Wash parts with soapy water. Wipe clean with a sponge, damp cloth or paper towel.
- Do not scrub with steel-wool pads or other abrasive cleaners.

Behind the Refrigerator

- Be careful when moving the refrigerator away from the wall. All types of floor coverings can be damaged, particularly cushioned coverings and those with embossed surfaces.
- Raise the leveling legs located at the bottom front of the refrigerator. See Level the Refrigerator in the Installation Instructions for leveling leg details.
- Pull the refrigerator straight out and return it to position by pushing it straight in. Moving the refrigerator in a side direction may result in damage to the floor covering or refrigerator.
- Lower the leveling legs until they touch the floor.
- When pushing the refrigerator back, make sure you don't roll over the power cord or icemaker supply line (on some models) and ensure the anti-tip bracket is engaged (if equipped).

Preparing for Vacation



- For long vacations or absences, remove food and unplug the refrigerator. Clean the interior with a baking soda solution of one tablespoon (15 ml) of baking soda to one quart (1 liter) of water. Leave the doors open.
- Press and release the Ice Off/Lock or Ice Off pad on the control panel to disengage the icemaker.
- If the temperature can drop below freezing, have a qualified servicer drain the water supply system (on some models) to prevent serious property damage due to flooding.

Preparing to Move

- Secure all loose items such as base grille, shelves and drawers by taping them securely in place to prevent damage.
- When using a hand truck to move the refrigerator, do not rest the front or back of the refrigerator against the hand truck. This could damage the refrigerator. Handle only from the sides of the refrigerator.
- Be sure the refrigerator stays in an upright position during moving

Replacing the light bulbs.

Refrigerator Lights



1. Unplug the power cord from the outlet.
2. Rotate the shield down while depressing the two tabs on the back side of the cover to remove it.
3. Turn the bulb counterclockwise.
4. Replace with an appliance bulb of the same or lower wattage.
5. Replace the shield.
6. Plug the refrigerator back in.

NOTE: Reveal® appliance bulbs may be ordered from GE Parts and Accessories, 800.626.2002.

Freezer Light



CAUTION: Light bulbs may be hot.

1. Unplug the power cord from the outlet.
2. Pull drawer out to the stop position.
3. Rotate the shield down while pushing it backwards to remove it.
4. Turn the bulb counterclockwise.
5. Replace with an appliance bulb of the same or lower wattage.
6. Replace the shield.
7. Plug the refrigerator back in.

NOTE: Reveal® appliance bulbs may be ordered from GE Parts and Accessories, 800.626.2002.

Troubleshooting Tips

Normal operating sounds

Do you hear what I hear? These sounds are normal.

-
- The new high efficiency compressor may run faster and longer than your old refrigerator and you may hear a high-pitched hum or pulsating sound while it is operating.
 - You may hear a whooshing sound when the doors close. This is due to pressure equalizing within the refrigerator.

WHIR!



- You may hear the fans spinning at high speeds. This happens when the refrigerator is first plugged in, when the doors are opened frequently or when a large amount of food is added to the refrigerator or freezer compartments. The fans are helping to maintain the correct temperatures.
- The fans change speeds in order to provide optimal cooling and energy savings.

CLICKS, POPS, CRACKS and SNAPS

- You may hear cracking or popping sounds when the refrigerator is first plugged in. This happens as the refrigerator cools to the correct temperature.
- The freezer control will click when starting or stopping the compressor.
- Expansion and contraction of cooling coils during and after defrost can cause a cracking or popping sound.
- On models with an icemaker, after an icemaking cycle, you may hear the ice cubes dropping into the ice bucket.
- On models with a dispenser, during water dispense, you may hear the water lines move at initial dispense and after dispenser button is released.

WATER SOUNDS



- The flow of refrigerant through the freezer cooling coils may make a gurgling noise like boiling water.
- Water dropping on the defrost heater can cause a sizzling, popping or buzzing sound during the defrost cycle.

- A water dripping noise may occur during the defrost cycle as ice melts from the evaporator and flows into the drain pan.
- Closing the door may cause a gurgling sound due to pressure equalization.

For additional information on normal icemaker operating sounds, see the About the automatic icemaker section.

Before you call for service...



| Problem | Possible Causes | What To Do |
|--|--|--|
| Motor operates for long periods or cycles on and off frequently. (Modern refrigerators with more storage space and a larger freezer require more operating time. They start and stop often to maintain even | Normal when refrigerator is first plugged in. | <ul style="list-style-type: none"> • Wait 24 hours for the refrigerator to completely cool down. |
| | Often occurs when large amounts of food are placed in refrigerator. | <ul style="list-style-type: none"> • This is normal. |
| | Door left open. | <ul style="list-style-type: none"> • Check to see if package is holding door open. |
| | Hot weather or frequent door openings. | <ul style="list-style-type: none"> • This is normal. |
| | Temperature control set at the coldest setting. | <ul style="list-style-type: none"> • See <i>About the controls</i>. |
| Refrigerator or freezer compartment too warm | Temperature controls not set cold enough. | <ul style="list-style-type: none"> • See <i>About the controls</i>. |
| | Warm weather or frequent door openings. | <ul style="list-style-type: none"> • Set the temperature control one step colder. • See <i>About the controls</i>. |
| | Door left open. | <ul style="list-style-type: none"> • Check to see if package is holding door open. |
| Frost or ice crystals on frozen food (frost within package is normal) | Door left open. | <ul style="list-style-type: none"> • Check to see if package is holding door open. |
| | Door openings too frequent or too long. | |
| Frequent “buzzing” sound | Ice Off feature is turned off, but the water supply to the refrigerator has not been connected. | <ul style="list-style-type: none"> • Press and release the Ice Off/Lock pad on the control panel to turn on the Ice Off feature, and then the  icon will be displayed. Keeping the Ice Off feature on will damage the water valve. |
| Small or hollow cubes | Water filter clogged. | <ul style="list-style-type: none"> • Replace filter cartridge with new cartridge or with plug. |
| Automatic icemaker | Ice Off feature is turned on. | |



| | | |
|--|--|--|
| does not work | | <ul style="list-style-type: none"> • Press and release the Ice Off/Lock pad on the control panel to turn off the Ice Off feature, and then the  icon will disappear. |
| | Water supply turned off or not connected. | <ul style="list-style-type: none"> • See <i>Installing the water line</i>. |
| | Freezer compartment too warm. | <ul style="list-style-type: none"> • Wait 24 hours for the refrigerator to completely cool down. |
| | Piled up cubes in the storage bin cause the icemaker to shut off. | <ul style="list-style-type: none"> • Level cubes by hand. |
| | Ice cubes stuck in icemaker. | <ul style="list-style-type: none"> • Turn off the icemaker, remove cubes and turn the icemaker back on. |
| Ice cubes have odor/taste | Food transmitting odor/taste to ice cubes. | <ul style="list-style-type: none"> • Wrap foods well. |
| | Interior of refrigerator needs cleaning. | <ul style="list-style-type: none"> • See <i>Care and cleaning</i>. • Keep an open box of baking soda in the refrigerator; replace every three months. |
| Slow ice cube freezing | Door left open. | <ul style="list-style-type: none"> • Check to see if package is holding door open. |
| | Freezer control not set cold enough. | <ul style="list-style-type: none"> • See <i>About the controls</i>. |
| Refrigerator has odor | Foods transmitting odor to refrigerator. | <ul style="list-style-type: none"> • Foods with strong odors should be tightly wrapped. • Keep an open box of baking soda in the refrigerator; replace every three months. |
| | Interior needs cleaning. | <ul style="list-style-type: none"> • See <i>Care and cleaning</i>. |
| Moisture forms on outside of refrigerator | Not unusual during periods of high humidity. | <ul style="list-style-type: none"> • Wipe surface dry and reset the refrigerator control one setting colder. • Turn off Energy Saver mode. |

| | | |
|--|--|--|
| Moisture collects inside (in humid weather, air carries moisture into refrigerator when doors are opened) | Too frequent or too long door openings. | |
| Refrigerator or freezer compartment light does not work | No power at outlet. | • Replace fuse or reset the breaker. |
| | Light bulb burned out or loose. | • See <i>Replacing the light bulbs</i> . |
| Door/drawer does not close by itself | Leveling legs need adjusting. | • See <i>Installing the Refrigerator</i> . |
| Hot air from bottom of refrigerator | Normal air flow cooling motor. In the refrigeration process, it is normal that heat be expelled in the area under the refrigerator. Some floor coverings will discolor at these normal and safe temperatures. | |
| Food freezing in the refrigerator | Food too close to the air vent at the back of the refrigerator. | • Move the food away from the air vent. |
| | Refrigerator control is set too cold. | • Move the refrigerator control to a warmer temperature setting one increment at a time. |
| Water has poor taste/odor | Water dispenser has not been used for a long time. | • Dispense water until all water in system replenished. |
| Water in first glass is warm | Normal when refrigerator is first installed. | • Wait 24 hours for the refrigerator to completely cool down. |
| | Water dispenser has not been used for a long time. | • Dispense water until all water is system replenished. |
| | Water system has been drained. | • Allow several hours for replenished supply to chill. |



| | | |
|---|--|--|
| Water dispenser does not work | Water supply line turned off or not connected. | <ul style="list-style-type: none"> • See <i>Installing the water line</i>. |
| | Water filter clogged. | <ul style="list-style-type: none"> • Replace filter cartridge or remove filter and install plug. |
| | Air may be trapped in the water system. | <ul style="list-style-type: none"> • Press the dispenser arm for at least 2 minutes. |
| | Water in reservoir is frozen because the controls are set too cold. | <ul style="list-style-type: none"> • Set the refrigerator control to a warmer setting and wait 24 hours. If water does not dispense after 24 hours, call for service. |
| Flow of water to dispenser or icemaker is slow | Water filter clogged. | <ul style="list-style-type: none"> • Replace filter cartridge or remove filter and install plug. |
| Water spurting from dispenser | Newly installed filter cartridge. | <ul style="list-style-type: none"> • Run water from the dispenser for 3 minutes (about 1 1/2 gallons). |
| No water or ice cube production | Supply line or shutoff valve is clogged. | <ul style="list-style-type: none"> • Call a plumber. |
| | Water filter clogged. | <ul style="list-style-type: none"> • Replace filter cartridge or remove filter and install plug. |
| | Filter cartridge not properly installed. | <ul style="list-style-type: none"> • Remove and reinstall filter cartridge, be certain that it locks into place. The blade on the end of the cartridge should be positioned vertically. |
| Water is leaking from dispenser | Glass not being held under the dispenser long enough after button is released. | <ul style="list-style-type: none"> • Hold the glass underneath the dispenser for 2–3 seconds after releasing the dispenser button. Water may continue to dispense after the button is released. |
| | Air may be present in the water line system, causing water to drip after being dispensed. | <ul style="list-style-type: none"> • Dispense water for at least 2 minutes to remove air from system. |



| | | |
|--|--------------------------------|--|
| <i>Handle is loose / handle has a gap</i> | Handle needs adjusting. | <ul style="list-style-type: none">• See <i>Attach the Fresh Food handle</i> and <i>Attach the Freezer handle</i> sections for detailed instructions. |
| <i>Refrigerator beeping</i> | This is the door alarm. | <ul style="list-style-type: none">• Close door. |

Warning

This content is compiled from multiple sources and is provided for reference purposes only. It may not be complete or fully applicable to all situations. If you are unable to resolve your issue, please contact the product manufacturer or an authorized service provider for official support.

