

Introduction

Buttons on the TV

If the batteries in your remote control are run down, you can use the buttons on your TV set. They have the following functions:

For models with below buttons on the set:

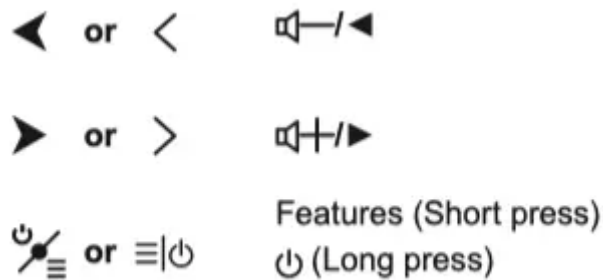

For models with only one button on the set:

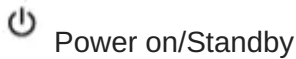

For models with below buttons on the set:

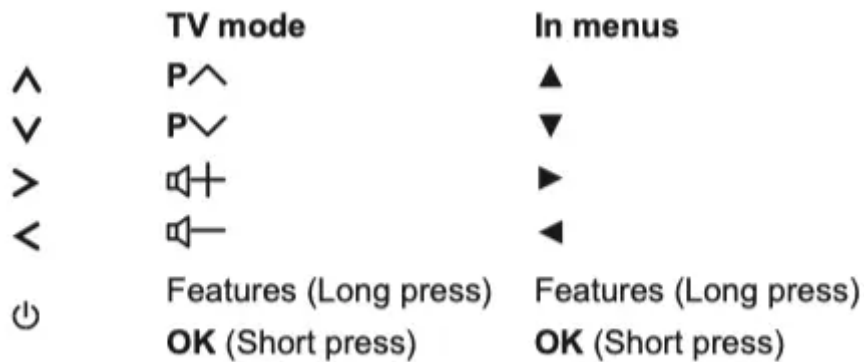

Note:

Figures and illustrations are provided for reference only and may vary depending on the model.

Sockets

Note: The location and names of the sockets on the TV may vary according to TV model, and not all sockets available on all models.

SPDIF socket (output)

The SPDIF socket can be used to connect a compatible digital audio receiver.



USB2.0 or USB2.0/SERVICE socket (input)

These USB sockets can be used to connect an USB device.

Note: the number of USB sockets on the TV may vary according to TV model.

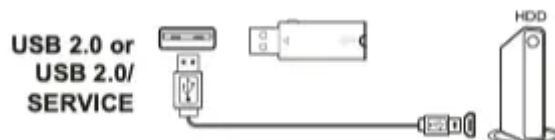

HDMI or HDMI (ARC) socket (input)

The HDMI (High-Definition Multimedia Interface) socket can be used to connect a PC with a compatible video card installed, certain DVD players or a high-definition compatible digital satellite decoder. This socket provides an uncompressed digital connection that carries both video and audio data by way of an integrated mini-plug cable.

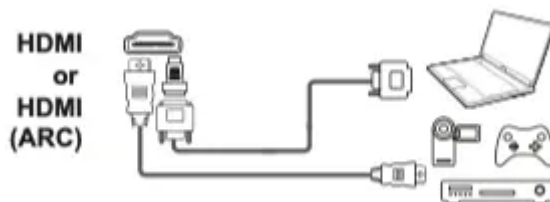

AV RCA audio + video sockets (input)

The AV IN sockets can be used to connect a range of equipment, including video recorders, camcorders, decoders, satellite receivers, DVD players, or games consoles. The VIDEO IN socket provides composite video connection.

Note: AV IN shares video (Y/VIDEO) and audio sockets with YPBPR.

AV IN adapter socket The AV IN adapter socket can be used to connect the attached AV adapter cable with VIDEO and AUDIO L & R IN sockets.

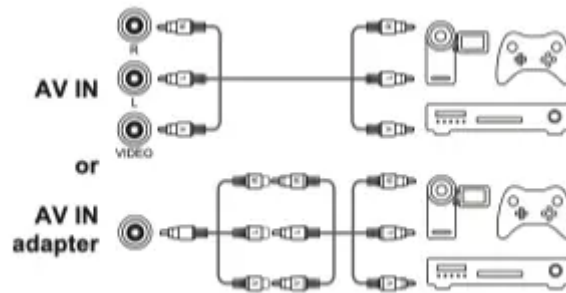

ANTENNA IN socket (input)

This socket can be used to connect the outside aerial.



LAN

RJ45 plug for connecting to external modem or network access equipment.



Headphone socket (output)

This socket can be used to connect headphones or stereo earphones.

Note: When the Headphone socket is connected, the speakers will be muted.

Warning: excessive sound pressure from earphones and headphones can cause hearing loss.









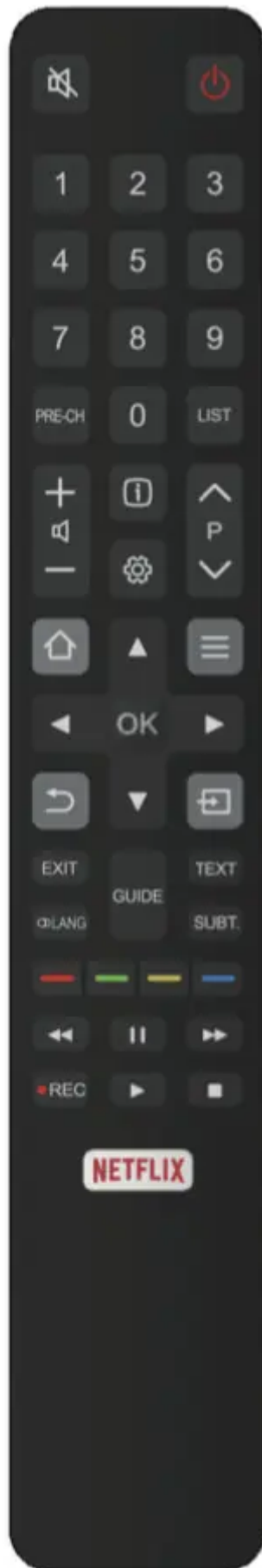











Remote Control Functions

Most of your television's functions are available via the menus that appear on the screen. The remote control supplied with your set can be used to navigate through the menus and to configure all the general settings.

Note: Figures and illustrations in this operation manual are provided for reference only and may differ from actual product appearance. The remote control type may be changed without notice.



	To switch the sound off and back on.
	Standby / quit standby.
Numeric buttons	To enter channel numbers or a digit.
PRE-CH	To return to the previous channel in TV mode.
LIST	To display the channel list.
	To control the volume.
	To display programme information, if available.
	To display the Settings menu.
	To change channels.
	To access or exit the Smart TV homepage.
	To display the Option menu.
	Navigation direction buttons.
OK	To confirm an entry or selection.
	To return to the previous menu or quit an App.
	To select input source.
EXIT	To exit the Settings menu.
	To select a sound type available for selected analogue TV programme; to select an audio language available for selected digital TV programme.
GUIDE	To toggle the Electronic Programme Guide on or off (only available for digital channels).
TEXT	To toggle Teletext on or off.
SUBT.	To select a subtitle language available for selected digital TV programme.
Colour buttons	To select tasks or Teletext pages; to be used for HbbTV function.
	To start fast reverse.
	To pause playback.
	To start fast forward.
	To record programs under DTV source.
	To start playback.
	To stop playback.
NETFLIX	To access the NETFLIX application. (Not available for some models.)

Installing Batteries

1. Push to open the back cover as illustrated.
2. Insert two AAA batteries according to the polarities marked on the battery case.
3. Replace the back cover as illustrated.

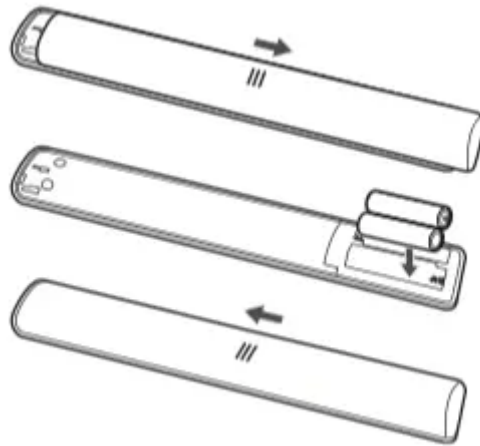

Getting Started

Switching On

Follow the instructions on this page on how to switch on your TV set and the remote control before going on to following pages describing how to use the channel set-up procedure.

1. Insert two AAA batteries in the remote control.

Precautions on using batteries:

- Only use the battery types specified.
- Make sure you use the correct polarity.
- Do not mix new and used batteries.
- Do not use rechargeable batteries.
- Do not expose batteries to excessive heat such as sunshine, fire or the like, throw them in a fire, recharge them or try to open them, as this could cause them to leak or explode.
- Remove the batteries from the remote control if you are not using it for a long period of time.
- Attention should be drawn to the environmental aspects of battery disposal.

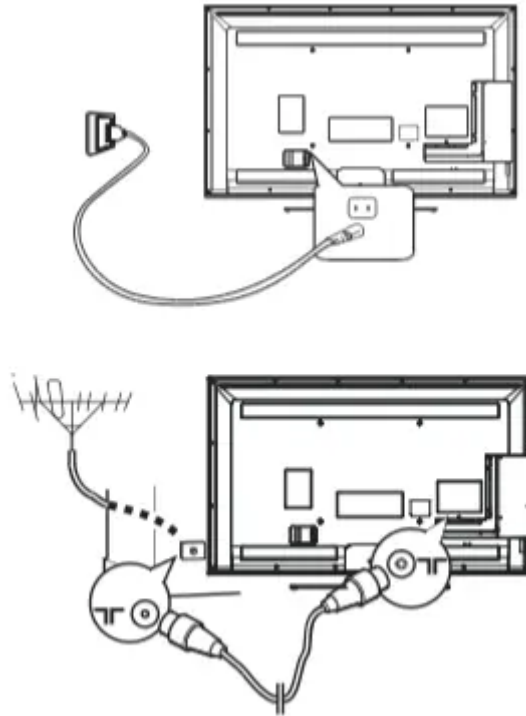

2. Connect the power cable FIRST to the television, THEN to a mains socket. (Note: If the power cable is connected to the television, please only connect the power cable to the mains socket.)

Your TV set should only be connected to an AC supply. It must not be connected to a DC supply. If the plug is detached from the cable, do not, under any circumstances, connect it to a mains socket, as there is a risk of electric shock.

Note: The figures are for representation only, the location of power socket of the television might differ depend on the model.

3. Connect an outside aerial to the ANTENNA IN socket at the back of the TV set.

The aerial socket (75 OHM - VHF / UHF / cable) can be used for connecting an external aerial or other equipment fitted.

Note: If you want to receive the signal from your cable or cable box, please connect a coaxial cable to the ANTENNA IN socket at the back of the TV set.

4. When powered on, the TV will be turned on directly or be in standby mode.

If the power indicator lights up, the TV set is in standby mode. Press the  button on the remote control or on the TV set to turn on the TV.

Switching Off

To put the TV set into standby mode, press the  button on the remote control. The TV set remains powered up, but with low energy consumption.

To switch off the TV set, unplug the mains socket from the mains outlet.

Network Connection



Your TV will require an internet connection to operate all functions. Data usage charges may apply. Please refer to your Internet Service Provider (ISP) for additional information.

To access the internet, you must subscribe high speed broadband internet service from your internet service provider. Your TV can be connected to your home network in two ways:

- Wired, using the RJ45 (LAN) connector on the back panel.
- Wireless, using the internal wireless or external wireless USB adapter and your home wireless network.

Note: The following instructions are just the usual ways to connect your TV to the wired or wireless network. The connection method may be different depending on your actual network configuration. If you have any questions about your home network, please refer to your ISP(Internet Service Provider).

Connecting to a Wired Network

To connect to a wired network:

1. Ensure you have:
 - An Ethernet cable long enough to reach your TV
 - A router or modem with an available Ethernet port
 - A high-speed internet connection
 - An Ethernet (LAN) port on the back of the TV
2. Connect your Ethernet cable to the router and to the Ethernet port on the back of the TV.
3. Use the Network Settings to configure the TV.

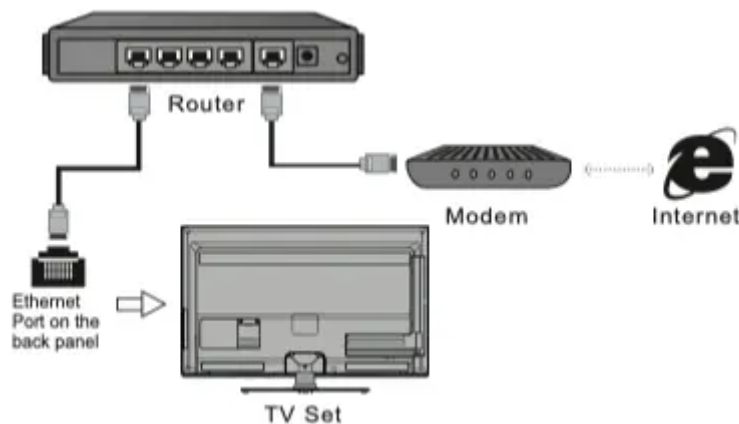

Connecting to a Wireless Network

To connect to a wireless network

1. Ensure you have:
 - A router broadcasting a high-speed wireless signal
 - A high-speed internet connection
2. Use the Network Settings to configure the TV.

Note: Some models may have no internal wireless module, you can use wireless network by inserting external wireless adapter into USB socket of the TV. Some external wireless adapters can't be compatible with the TV.

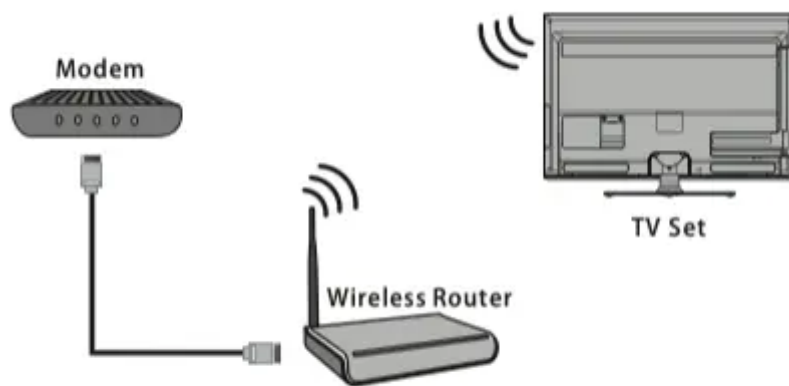



Built-in wireless connection

Network Settings

You can set up your TV so that it can access the Internet through your local area network (LAN) using a wired or wireless connection.

Connecting to a Wired Network

1. Press  on the remote control, select Network > Wired settings and press OK/▶ to enter.
2. Check the network information or enter IP settings to set the IP address, Subnet mask, Default gateway and Primary DNS values manually. Then press ▲/▼/◀/▶ to select OK and press OK to confirm. The TV set will try to connect to the network and inform you about the result.
3. Press  to return to the Network menu.
4. If you want to check the Internet connectivity, press ▲/▼ to select Connecting test and press OK/▶.

Connecting to a Wireless Network

Your TV is equipped to be connected to your home network wirelessly. To do that you need a wireless router or modem.

1. Press  on the remote control, select Network > Wireless connection> Wireless connection and press OK/▶ to enter.
2. Press ▲/▼ to select On and press OK to confirm.
3. You can set the wireless network connection in 3 ways:

a) Scan

- When Wireless connection is turned on, the TV will search all access points within range. Access points found by the TV will be displayed.
- Press ▲/▼ to select an available access point, then press OK/▶ to connect.
- Select All wireless (if available) to find more access points.

Note: If you select a protected access point, you will have to enter the corresponding password. Press OK on the remote control to display the virtual keyboard to enable you to enter the password.

b) Manual

Press ▲/▼ to select Manual and press OK/▶ to enter. You will be prompted to enter the correct SSID of an available wireless router, select its security type and enter the password (if needed) to set up the connection.

c) Auto

If your AP (Access Point) supports WPS (Wi-Fi Protected Setup), you can connect to the network via PIN (Personal Identification Number) or PBC (Push Button Configuration). WPS will automatically configure the SSID and WPA key in either mode.

Press ▲/▼ to select Auto and press OK/▶ to enter.

- PIN: Select PIN and press OK/▶ to enter. Choose a random PIN code. Make sure this code is installed on the AP. (For the procedures, refer to your router manual.) Select OK and press OK to set up the connection.
 - PBC: If your router has a PBC push button, select PBC and press OK/▶ to enter. Press the PBC push button on your router within 2 minutes before you select OK and press OK again. Your TV will automatically acquire all the network setting values it needs and connect to your network.
- Press  to return to the Network menu.

4. If you want to check the Internet connectivity, press ▲/▼ to select Connecting test and press OK/▶

Initial Setup

Initial setup involves selecting all the settings required to be able to search for and store all the analogue and digital channels you can receive.

Make sure that the television is switched on and follow all the steps in turn specified hereafter.

Note: If the channel search retrieved only the analogue channels it could be caused by poor broadcasting and therefore is not covered by manufacturer warranty. Manufacturers cannot be held responsible for lack of or poor broadcasting in some areas.

The first time you switch the set on, the Initial Setup wizard opens, which guides you through the initial setup process.

1. Press ▲/▼ to select your language, then press OK to confirm and then press OK again to enter the next step.

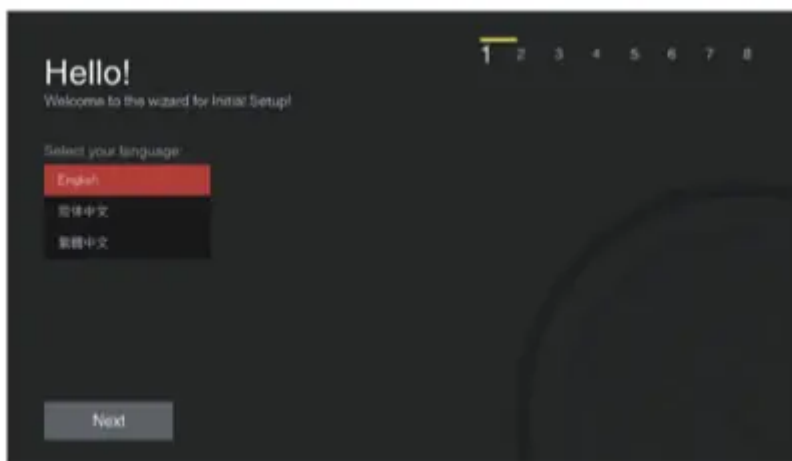

2. Press ▲/▼ to select your location, then press OK to confirm and then press OK again to enter the next step.

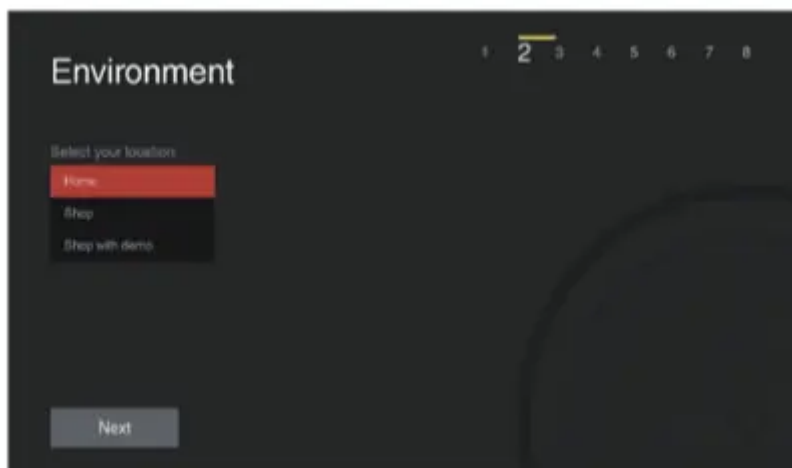

3. Press ▲/▼ to select your country, then press OK to confirm and then press OK again to enter the next step.

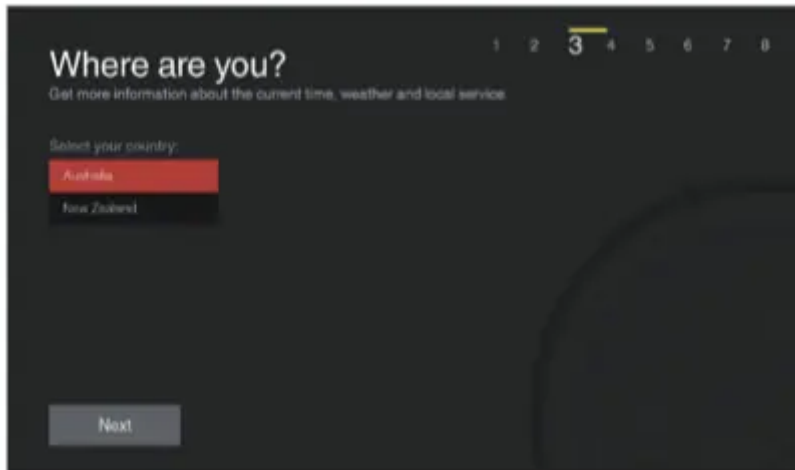

4. Read the terms and conditions carefully and highlight Agree and press OK to enter the next step.

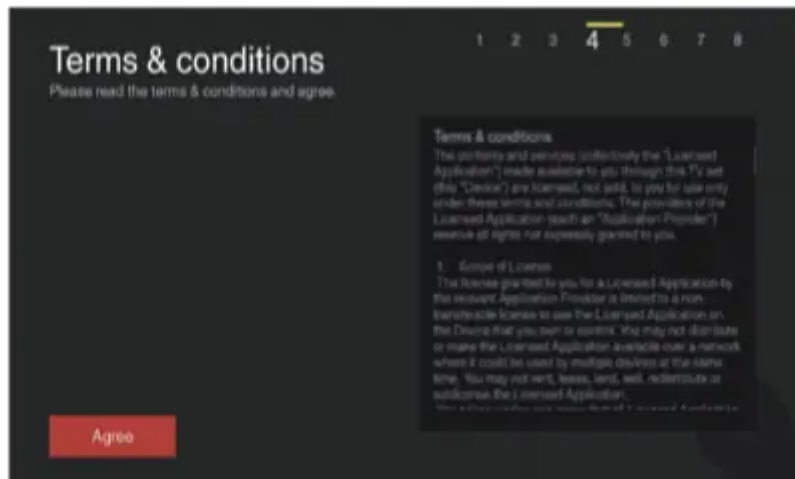

5. Network setup process:

- Press ▲/▼ to select your network connection type (Wired or Wireless), then press OK to confirm and then press OK again to enter the next step.
- Follow the guides on the screen and press the corresponding buttons on the remote control to proceed.

Note: You can also skip this step by selecting “Skip”.

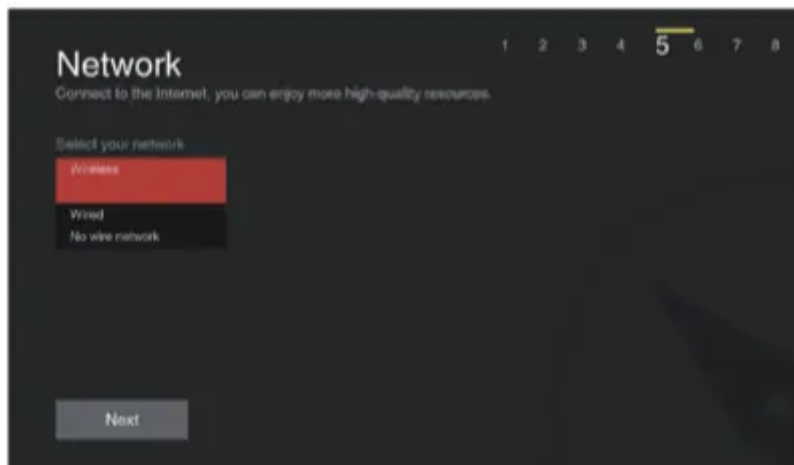

6. Name your TV as you like if necessary.

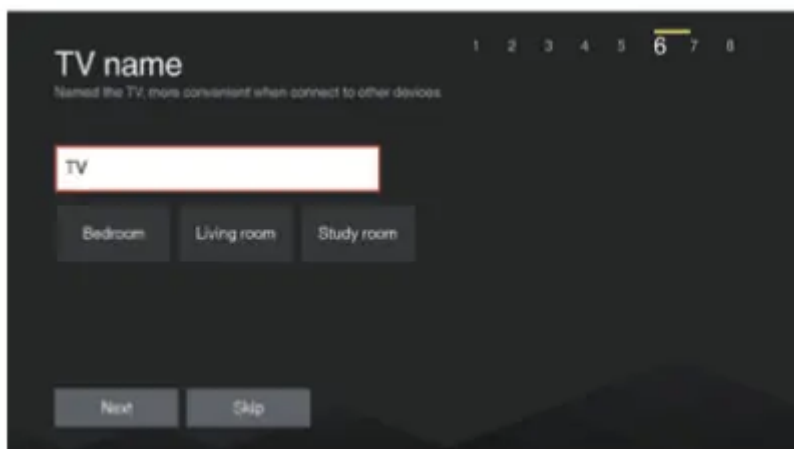

7. Channel Installation

- Press ▲/▼ to select Antenna and press OK to enter next item.
- Press ▲/▼ to select a channel type and then follow the guides on the screen and press the corresponding buttons on the remote control to proceed.

Note: To prevent the channel installation process from being interrupted, wait for the message indicating that the installation is complete. You can also skip this step by selecting “Skip”. In this case, to search and store your channels you may do an automatic channel search by following the instructions in the next section Automatic Channel Search.

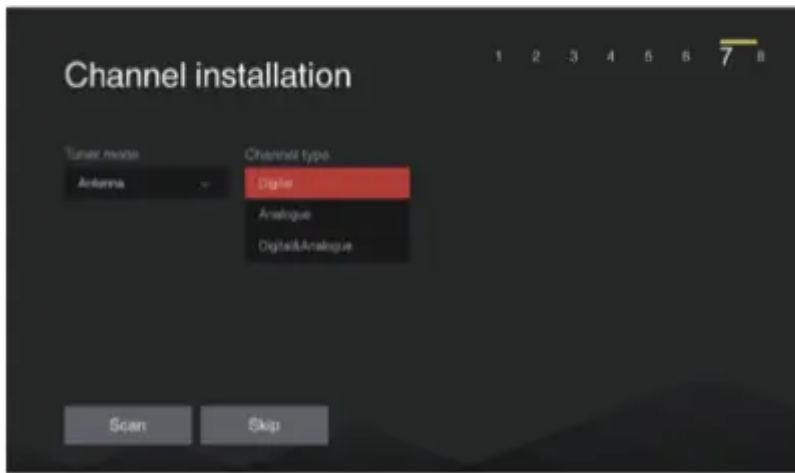

8. When the initial setup is completed, the Congratulations message appears. Press OK to confirm.



Basic Operation

Accessing Channels

Using the numeric buttons: press the corresponding numeric buttons on the remote control to access the channels.

Using the **P** buttons: press the **P** buttons on the remote control or the corresponding buttons on the TV set to scroll through the channels.

Using the LIST button: press the LIST button on the remote control to display the channel list and press **▲/▼/◀/▶** and OK to select channels.

Watching Connected Devices

Press **□** (SOURCE) on the remote control to display the source list. Use **▲/▼** to toggle between TV and other input sources, press OK to confirm. Or you can press **P** to cycle through all TV channels and other input sources.

Adjusting Volume

Volume control: press the V+/- buttons or the **▲/▼** on the remote control or the corresponding buttons on the TV set to increase or decrease the volume.

Sound mute: press the **🔇** button to temporarily mute the sound. Press this button again or the V+ button to restore the sound.

Using TV Settings

1. Press **⚙️** on the remote control to display the Settings menu.

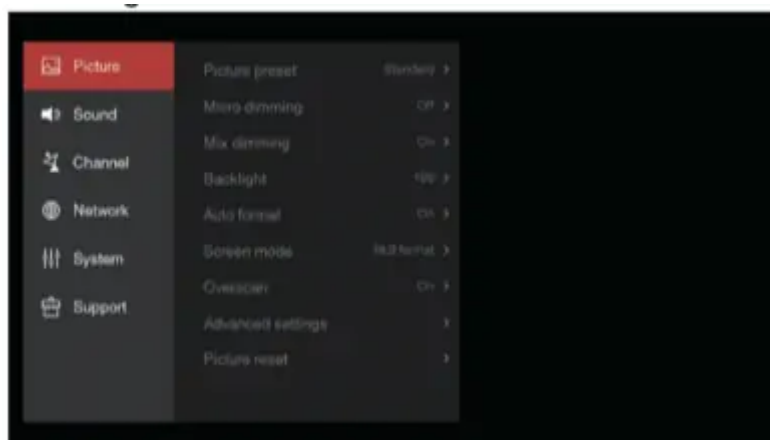

2. Press **▲/▼** to select the desired item, then press OK/▶ to enter the corresponding submenu.

3. In submenus, press ▲/▼ to select menu options, then press OK/▶ to enter the option list, the adjustment interface, or the corresponding submenu.

4. Press ↶ to return to the previous menu.

5. Press EXIT or ⚙️ to close the menu.

Note:

You can also press ≡ on the remote control, select Settings (if available) and press OK to enter the Settings menu. Some options may not be available for certain signal sources.

Selecting Menu Language

You can choose your preferred menu language following the instructions below.

1. Press ⚙️ on the remote control, select System > Menu language and press OK/▶ to enter.

2. Press ▲/▼ to select your desired language to display the menus and press OK to confirm.

3. Press EXIT or ⚙️ to close the menu.

Instant Power On

This function enables you to turn on your TV quickly.

1. Press ⚙️ on the remote control, select System > Advanced settings > Instant power on and press OK/▶ to enter.

2. Press ▲/▼ to select On and press OK to confirm.

3. Press EXIT or ⚙️ to close the menu.

Automatic Channel Search

This section describes how to search and store channels automatically. This may be done in any of the cases below:

- you have selected "Skip" in channel installation part when doing the initial setup;
- you see "No program info now, please search channels first!" in TV mode;
- you want to update your channels.

1. In TV mode, press ⚙️ on the remote control and select Channel > Channel scan. Press OK/▶ to enter.

2. The TV installs and arranges channels according to your country. Press ▲/▼ to select Country, and press OK/▶ to enter. Enter the default password 1234 or your own password in case you have changed the password in the System > Lock menu. Press ▲/▼ to select your country and press OK/▶ to confirm.

3. Press ▲/▼ to select Automatic search, then press OK/▶ to enter.

4. Press ▲/▼ to select Channel type (Digital & Analogue, Digital or Analogue), press ▲/▼ to highlight Search, then press OK to start the automatic search for all digital and/or analogue channels.



5. The channel search may take a few minutes. During the process, you can press OK to stop the search halfway.

6. After the automatic search, channels are arranged in a preset order. If you wish to skip channels, modify the preset order, rename or delete channels, press  on the remote control, select Channel > Channel organiser and press OK/▶ to enter.

Homepage Operation

Note: This manual is for common use. Figures and illustrations in this User Manual are provided for reference only and may differ from actual product appearance. And for some models, certain options are not available.

You can select all the features from homepage.

1. Press  to display homepage.
2. Press ▲/▼/◀/▶ to select icons from the screen list.
3. Press OK to enter each option.
4. To exit the menu, press EXIT or  repeatedly.

Homepage contains 4 parts: Home, Videos, TV, and Apps. Use ◀/▶ to switch among them.

Shortcut: Press ▲ to move the cursor to the very top of the screen under any homepage, the  (Source Manager) option will appear. You can access source menu directly here.







WARNING:

- Configure the network settings before using Smart TV.
- Slow responses and/or interruptions may occur, depending on your network conditions.
- If you experience a problem using an application, please contact the content provider.
- According to circumstances of the contents provider, an application's updates or the application itself may be discontinued.

- Depending on your country's regulations, some applications may have limited service or not be supported.

Using Homepage - Home

This section explores the most commonly used menu of your TV.

Press  on the remote control to display the homepage. Press /// to enter the Home page and select icons from the screen list. Press OK to enter each option. To exit the menu, press EXIT or  repeatedly.

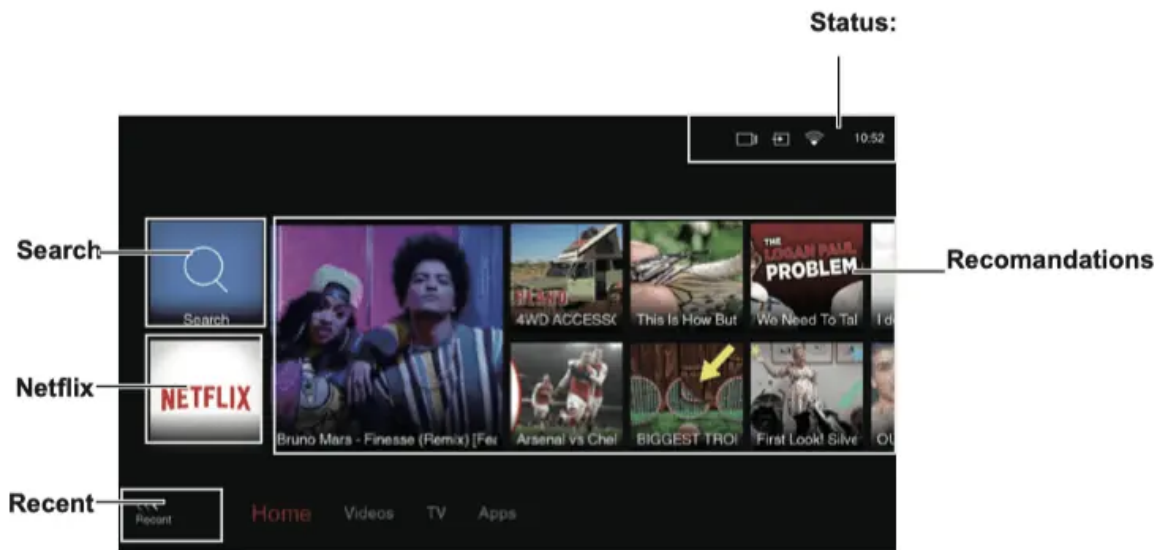

Recent: This page shows your recently viewed programmes. To delete the history, press  to display the submenu, choose Delete one/ Delete all and operate according to screen display.







Search: You can search for your desired programmes using the virtual keyboard.

Netflix: With a Netflix unlimited membership, you can instantly watch TV episodes & movies streamed over the Internet watch TV episodes & movies streamed over the Internet from Netflix right to your TV.

Note: Netflix is available in certain countries. Unlimited membership required. More information at netflix

Using Homepage - Videos

Note: The information displayed will be updated periodically.

Press  on the remote control to display the homepage. Press /// to enter the Videos page and select icons from the screen list. Press OK to enter each content To exit the menu, press EXIT or  repeatedly.



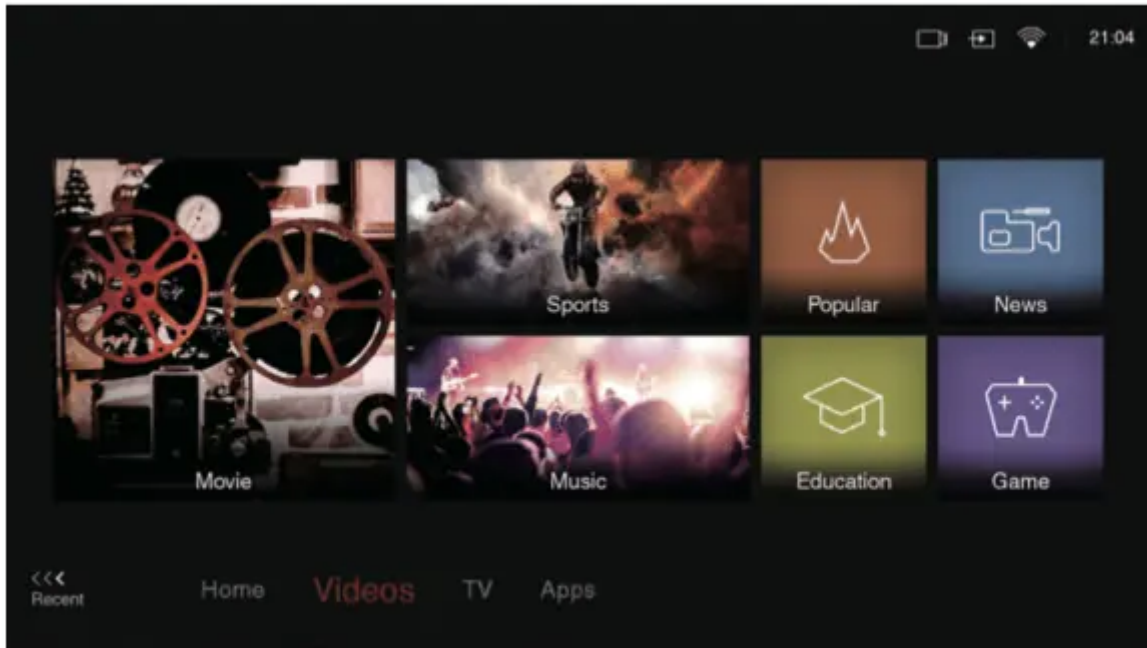



This interface enables you to search for videos by genre, such as movie, sport, music, popular, news, education, and game, etc. For details, refer to your local platform.



Using Homepage- TV

Note: Some options may not be available for certain signal sources.

This section explores the input sources of your TV.

Press  on the remote control to display homepage. Press /// to enter TV page and select input source you want from the screen list, then press OK to confirm. To exit TV page, press EXIT or  repeatedly.

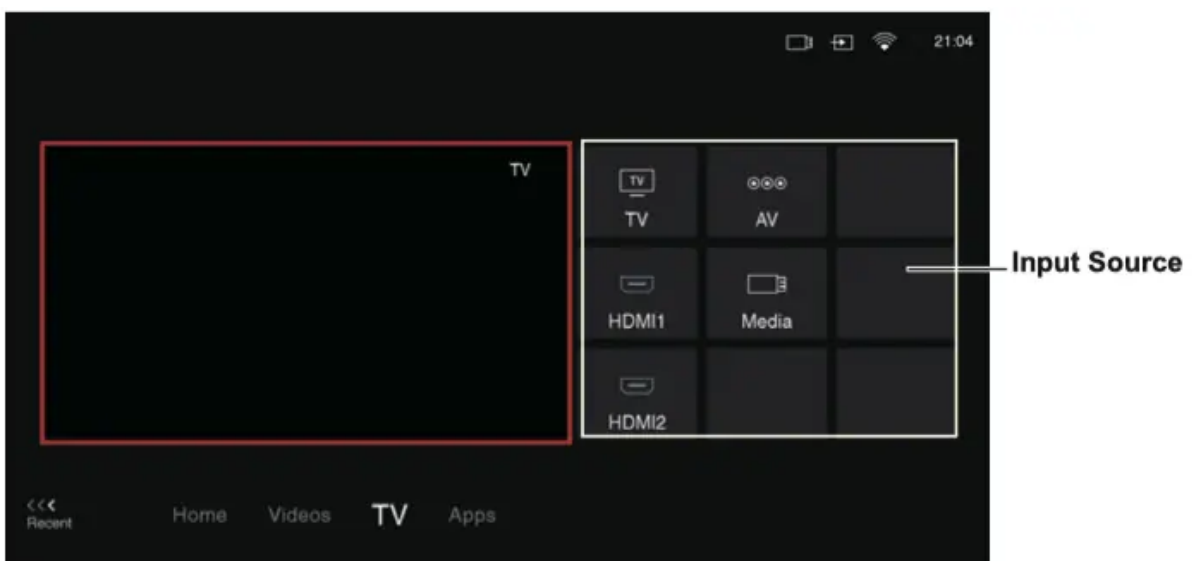

TV window

Displays the current selected TV broadcast programme.



Input Source

Select the input source from devices connected to TV through different ports, including TV, AV, HDMI1, HDMI2, and Media. Press ▲/▼/◀/▶ to select your desired source, and then press OK to confirm.

Note: The available source might differ depending on the model.

Using Homepage- Apps

Note: The pre-installed apps or items can not be deleted. And the apps (regardless of order) listed in the below figure may differ from actual product. For some models, certain apps are not available.

Press  on the remote control to display the homepage. Press ▲/▼/◀/▶ to enter the Apps page and select icons from the screen list. Press OK to enter each option. Press EXIT or  repeatedly to return to the homepage.

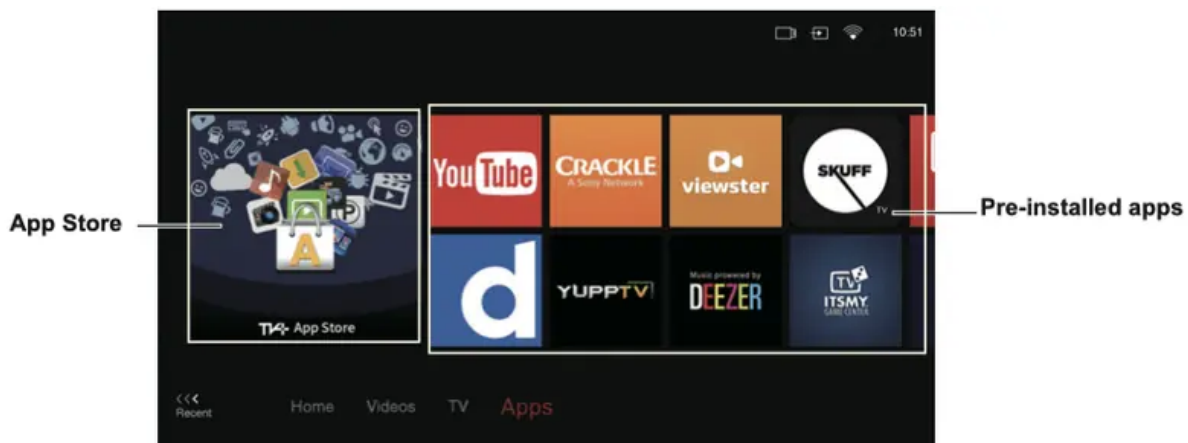

App Store: Many useful and entertaining apps are available for downloading. After entering the App Store, you will see the recommendations. Press ▲/▼/◀/▶ to select, press OK to enter.

Pre-installed apps: These are recommended Apps. Highlight an app and press OK to open it.

Note: The pre-installed apps or items can not be deleted.

Note: You may need a webcam to use certain apps. The webcam is an optional accessory, and is available by separate purchase. Only use the specified webcam. Some external devices like webcam, smartphone and joystick may not be supported.



Using More of Your TV

Setting up Your Favourite Channels

You can create a list of your favourite TV channels.

1. Press LIST.
2. Press ▲/▼/◀/▶ to scroll through the channel list and press the green button to add the selected channel to your favourite list.
3. Repeat this procedure to set up other favourite channels.
4. Press ▲/▼/◀/▶ to select a channel, press OK to watch it or press the green button to remove it from your favourite list.
5. Press  to organize the channels. Use ▲/▼/◀/▶ to select a channel, then press the green button to remove or add it to your favourite channels. Or press OK button to do more operations such as swap, insert, hide, edit or delete the selected channel.
6. Press LIST or EXIT to exit.

Energy Saving

1. Press  on the remote control, select Picture > Advanced settings > Dynamic backlight and press OK/▶ to enter.
2. Press ▲/▼ to select On to activate power saving mode.
3. Press EXIT or  to close the menu.

SPDIF Type

Connect the TV to an audio device through the SPDIF output. To select a proper sound type for your SPDIF output, press  on the remote control, select Sound > Advanced settings > SPDIF type and press OK/▶ to enter. Press ▲/▼ to select an option and press OK to confirm.



- If you select Auto, the SPDIF output format is
 - Dolby Digital when the programme's sound format is Dolby Digital or Dolby Digital Plus or HE-AAC.
 - PCM when the programme's sound format is MPEG.
- If you select PCM, the SPDIF output format is PCM, regardless of the programme's sound format.
- If you select Off, this turns off the audio output from the audio device connected to the SPDIF output.

Note: The options you may choose depend on the programme you are watching. If the sound is ahead of the picture, you can select SPDIF delay from the Sound menu, press OK/▶ then press ◀/▶ to adjust the delay time to synchronize the sound with the picture.



Audio Description

Audio description refers to an additional narration track for blind and visually impaired viewers of visual media, including television programmes and movies. The description narrator talks through the presentation describing what is happening on the screen during the natural pauses in the audio (and during dialogue if deemed necessary).

You can use this feature if the current broadcast contains audio description.

1. Press  on the remote control, select Sound > Advanced settings > Audio description and press OK/▶ to enter.
2. Select Speaker or Headphone, press OK/▶ to enter, press ◀/▶ to select Audio description and press OK to confirm.
3. To adjust the volume for audio description in case this function is turned on, press ▲/▼ to select AD volume, press OK/▶ then press ◀/▶ to set the volume. Press ↵ to return.
4. Press EXIT or  to close the menu.

Diagnostics on Digital TV Channels

1. Press  on the remote control and select Channel > Channel diagnostics.
2. Press OK/▶ to display some signal information on the current digital channel, such as signal strength, frequency, etc.
3. Press OK to confirm.
4. Press EXIT or  to close the menu.

Using Subtitles

You can enable subtitles for each TV channel. Subtitles are broadcast via Teletext or DVB-T digital broadcasts. With digital broadcasts, you have the additional option of selecting a preferred subtitle language.



Turning On/Off Subtitles

1. Press  on the remote control, select Channel > Subtitle and press OK/▶ to enter.
2. Select the Subtitle option, press OK/▶ to enter, press ▲/▼ to select On or Off and press OK to confirm.

3. Press EXIT or  to close the menu.



Turn on the subtitle before doing below operations.

Enabling Subtitle Languages on Digital TV Channels

1. Press  on the remote control, select Channel > Subtitle > Digital subtitle language 1st and press OK/▶ to enter.
2. Press ▲/▼ to select a subtitle language as your preferred language and press OK to confirm.
3. Press ▲/▼ to select Digital subtitle language 2nd and press OK/▶ to enter.
4. Press ▲/▼ to select a secondary subtitle language and press OK to confirm.
5. Press EXIT or  to close the menu.



Shortcut operation: Press SUBT. on the remote control to directly select a subtitle language available for the selected digital TV programme.

Selecting a Subtitle Type on Digital TV Channels

6. Press  on the remote control, select Channel > Subtitle > Subtitle type and press OK/▶ to enter.
7. Press ▲/▼ to select a subtitle type and press OK to confirm. You can select Hearing Impaired to display the hearing impaired subtitles with your selected language.
8. Press EXIT or  to close the menu.



Using Teletext

Selecting Decoding Page Language

1. Press  on the remote control, select Channel > Teletext > Decoding page language and press OK/▶ to enter.
2. Press ▲/▼ to select a proper type of language in which Teletext will display and press OK to confirm.
3. Press EXIT or  to close the menu.

Digital Teletext Language

On digital TV channels, depending on the broadcaster, you may be able to enjoy a service with multiple initial Teletext pages in different languages. This function allows you to select an available language as primary language, which relates to different initial Teletext pages.

1. Press  on the remote control, select Channel > Teletext > Digital teletext language and press OK/▶ to enter.
2. Press ▲/▼ to select a language and press OK to confirm.
3. Press EXIT or  to close the menu.

Software Update



Note: Do not switch off or unplug the TV until the upgrade is completed.

Press  on the remote control, select Support > Software update and press OK/▶ to enter. You have the following options to update the software.

- By USB: Enables you to install a new version software from a USB stick. Insert the USB stick in which a new version software is stored into a USB socket of the set. Select By USB and press OK/▶ to enter. Follow the on-screen instructions to complete the process.
- By channel: Enables you to install the latest version software if available from the broadcast. Select By channel and press OK/▶ to enter. Follow the on-screen instructions to complete the process.
- By network: Enables you to download and install the latest version software from the Internet. Make sure to set up a wired or wireless network connection first then select By network and press OK/▶ to enter. Follow the on-screen instructions to complete the process.

Note: Do not disconnect power and network connection during the upgrade.

Changing to Shop or Home Mode

1. Press  on the remote control, select System > Environment and press OK/▶ to enter.
2. Press ▲/▼ to select Home, Shop or Shop with demo and press OK to confirm.
3. Press EXIT or  to close the menu.

Note: If Shop or Shop with demo mode was selected, it is not MEPS compliant. In Home mode, TV will be put into standby mode automatically if there is no operation in 4 hours. This feature can be deactivated in the System > Timer > Auto standby menu.

Reset shop

Allows you to reset the TV to factory default settings.

1. Press  on the remote control, select Support > Reset shop and press OK/▶ to enter.

2. Use the numeric buttons to enter the password 1234 or your own password incase you have changed the password.
3. Press ◀/▶ to select OK and press OK to confirm.
4. The Initial setup wizard appears. Follow the instructions in the section Initial setup.

T-Link

Use this function to search for CEC devices connected to the HDMI sockets in your TV and enable one-touch play and one-touch standby between CEC devices.

Enabling or Disabling T-Link

1. Press ≡ on the remote control, press ▲/▼ to select T-Link and press OK/▶ to enter.
2. Press ▲/▼ to select T-Link and press OK/▶ to enter.
3. Press ◀/▶ to select On or Off and press OK to confirm.
4. Press EXIT to close the menu.

Using Auto Power On

Enables the TV to automatically power on when you power on a CEC device (e.g. DVD) with the device's remote. Select On to enable this function.

Using Auto Standby

Enables all CEC devices to automatically go to the standby mode when you turn off the TV with the TV remote. Select On to enable this function.

Note: The CEC functions depend on the devices connected and it is possible that some devices may not interoperate correctly when connected to this TV. The user manual or the manufacturer of the problematic devices should be consulted for further information.

Time Shift

Allows you to pause, fast forward and rewind live TV, so you don't have to miss any part of your favourite programs. Before you use the function, connect a USB drive to the TV first. For the first time, you should complete the disk setup for the USB drive.

1. Press ≡ on the remote control and select Time Shift, then press OK to confirm.
2. Follow the directions on the screen to do the disk setup if you use time shift for the first time.
3. After the disk setup is done, time shift will start, and the time shift menu displays on the screen.
4. For later use, press ≡ and select Time Shift. press OK to display the time shift menu and operate according to the on-screen prompt.

5. Pressing Stop button stops the time shift and exits.

- When the time shift menu disappears and only the timing of the time shift remains on the screen, you can press  to call out the time shift menu.

Notes:

- Before you plug the USB drive to TV, make sure you have backed up the data on the drive to avoid unforeseen malfunction and data loss.
- We recommend that you use a USB drive with at least 1GB free space and a disk speed faster than 5.0MB/sec.
- The bigger the USB drive free space for time shift, the bigger the recording length.

Quick Access of Time Shift:

Insert a USB disk, press PAUSE() on the remote control, it will access Time Shift automatically.

Using EPG (Electronic Programme Guide)

EPG is an on-screen guide that displays scheduled digital TV programmes. You can navigate, select, view and record programmes.

Note: The DTV EPG does not require an internet connection. To use the DTV EPG, HbbTV must be set to Off. when HbbTV is set to On, then it will enter the HbbTV EPG directly. Please refer to “HbbTV” part of this manual for assistance to set HbbTV to on or off .

1. Press  on the remote control, select Channel > EPG and press OK/▶ to enter, or press GUIDE on the remote control, the Program Guide menu will appear, which allows you to get information about the current or next programme playing on each channel. Navigate through the different programmes using the ▲/▼/◀/▶ buttons on the remote control.
2. Use the related buttons shown at the bottom of the screen to view EPG.

- Prev day: Press  to display EPG of the previous day.
- More: Press OK to view more information.
- Program filter: Press to display programme filter for digital TV programmes.
- Custom schedule: Press the red button to set a schedule.
- Select date: Press the green button and OK to select date.
- Schedule list: Press the yellow button to view your schedule list.



3. Press GUIDE or EXIT to exit EPG.

PVR (Personal Video Recorder)

Allows you to record your favourite TV programs. Before you use the function, connect a USB drive to the TV first.

Note: The feature is available only in selected products and, due to specific TV network limitations and country technical requirements, might not be available in product or place of installation.

Feature might also be blocked by TV network due to copyright protection (HD content, recording protection). Please use  on the remote control to check if the feature is available in your product.

1. Press  on the remote control and select PVR.
2. Press OK/▶ to enter and select Record. It starts to record automatically.
3. Press BLUE button on the remote control to access Settings and use ▲/▼/◀/▶ to adjust the recording duration.
4. Press  to stop recording manually, the recorded file will be saved. In normal operation, the recording will stop automatically when the recording duration expires.
5. In recording, the PVR mini pane will also show on the screen to indicate the recording progress.
6. To watch the recorded program, exit PVR mode first, Press  and go to TV > Media > PVR, then select the related record file. Press OK to play. (It is the same if you record a digital radio program).

Notes:

- This feature is available only for digital non encrypted channels.
- Before you connect the USB drive to the TV, make sure you have backed up the data in the drive to avoid the loss of your important data due to unforeseen malfunction.
- The bigger the USB drive free memory for the PVR function, the bigger the recording length.
- If you want to change channel or signal source during recording, store the recording data before changing the channel or source.
- The TV cannot play files normally if the parameters of the file exceed the limitations of the system, the file format is not supported, the file is damaged, or the file cannot be decoded.
- Do not disconnect the USB drive when the system is reading a file or transmitting data, otherwise the system or the drive may be damaged.

Network Waking up

This function allows you to turn on your TV from standby mode via a network. To use this function, please make sure:

1. Your TV is connected to an effective home network;
2. The desired controller, such as a smartphone, is connected to the same network as your TV;
3. An App which supports network waking up function, has been installed into the controller;
4. Network standby is set to On in the Network menu.

When the TV is in networked standby mode, you can use the App to wake up the TV remotely.

Password in Parental Control

- The default password is 1234. You can change it to a new one.
- The super password is 0423. If you forget your code, enter the super password to override any existing codes.

Other Information

Problems & Solutions

Note: Problems & solutions 1 to 2 are for the TV models which have network functions, so users of non-connected TV models can disregard them.

1. Fail to link to the network.

- Check if your TV is connected with the network;
- Reboot your TV;
- Consult your internet service provider, to confirm if access of your router is supported. Refer to the operation manual of your router.
- Make sure if your TV is connected with the router. if the router is well connected and powered on, try to change a new router and network line, and use your PC to have a test. Should your problem persists, try to consult Client Service Centre.

2. The video could not be played smoothly.

- Videos from your USB flash drive --- It may result from data transmission, or its code flow is far beyond the supported formats of this TV set.
- Videos downloaded from internet, or online videos.
 - a. It may be caused by the lower bandwidth of your network. A high network speed is required to handle online videos.
 - b. Peak internet usage times may affect the bandwidth.

c. Check if any other computers on the same network are also operating, as they may be using up bandwidth. Especially if they are downloading or displaying on-line videos.

d. The video may not be smooth itself, it is not the problem of your TV or network.

3. When two mobile hard disks are connected with the TV at the same time, they will not be recognized some times.

- All mobile hard disks consume a lot of power, which may result in power supply problems. We recommend inserting only one hard disk, or a low power consumption mobile hard disk.

4. The video from a mobile hard disk (USB) is playing with no sound.

- The audio format of the video in your mobile hard disk is not supported by the TV player.

5. Some videos fail to play.

- The formats of the videos may not be supported by the TV, especially videos shot by certain kinds of cameras, generally with their private protocol of formats, which are not compatible with your TV.

6. Video stops playing midway.

- Mistakes may occur when videos are copied or compressed, so they may automatically stop playing during playback.

7. What should I pay attention to, when I do SW updating

- No power cuts when SW updating;
- Avoid any operations with your remote control when SW updating;
- Be patient because the SW updating process may takes a little bit longer time.

8. There are no distinct changes of TV interface after SW updating.

- Under certain conditions, SW updating may not only update or add new functions but also improve the performance of the TV set, without distinct changes of interface. Also, there may be no changes to the user interface at all.

9. External device cannot be recognized

- Some external devices (e.g. webcam, smart phone, tablet, game handle, and external wireless adapter) may not be compatible with the TV and cannot be supported for certain functions (nScreen, wireless display, gesture control, face recognition, if any). Please try a similar device. If it does not work, contact your local dealer.

Troubleshooting

Note: Most problems you encounter with your TV can be corrected by consulting the following troubleshooting list.

No picture, no sound

1. Check if the fuse or circuit breaker is working.
2. Plug another electrical device into the outlet to make sure it is working or turned on.
3. Power plug is in a bad contact with the outlet.
4. Check the signal source.

No color

1. Change the color system.
2. Adjust the saturation.
3. Try another channel. Black-white programme may be received.

Remote control does not work

1. Change the batteries.
2. Batteries are not installed correctly.

No picture, normal sound

1. Adjust the brightness and contrast.
2. Broadcasting failure may happen.

Normal picture, no sound

1. Press button ► to increase volume.
2. Volume is set to mute, press the Mute button to restore sound.
3. Change the sound system.
4. Broadcasting failure may happen.

Unorderly ripples on the picture

It is usually caused by local interference, such as cars, daylight lamps and hair driers. Adjust the antenna to minimize the interference.

Blank screen in VGA mode

Perhaps the TV can not recognize the resolution set by the PC. Suggest to change to the best resolution or other standard resolutions of the Windows system.

Snowy dots and interference

If the antenna is located in the fringe area of a television signal where the signal is weak, the picture may be marred by dots. When the signal is extremely weak, it may be necessary to install a special antenna to improve the reception.

1. Adjust the position and orientation of the indoor/ outdoor antenna.
2. Check the connection of antenna.

3. Fine tune the channel.

4. Try another channel. Broadcasting failure may happen.

Ignition

Black spots or horizontal streaks appear, or the picture flutters or drifts. This is usually caused by interference from car ignition system, neon lamps, electric drills, or other electrical appliance.

Ghost

Ghosts are caused by the television signal following two paths. One is the direct path, the other is reflected from tall buildings, hills, or other objects. Changing the direction or position of the antenna may improve the reception.

Radio frequency interference

This interference produces moving ripples or diagonal streaks, and in some case, loss of contrast in the picture. Find out and remove the radio interference source.

* To bring you better visual experience, please remove all labels, if any, from TV front panel and screen before use.

* Figures and illustrations in this User Manual are provided for reference only and may differ from actual product appearance. Product design and specifications may be changed without notice.

Warning

This content is compiled from multiple sources and is provided for reference purposes only. It may not be complete or fully applicable to all situations. If you are unable to resolve your issue, please contact the product manufacturer or an authorized service provider for official support.