

Operating Instructions

Features of Your Microwave

(Throughout this manual, features and appearance may vary from your model.)

Features

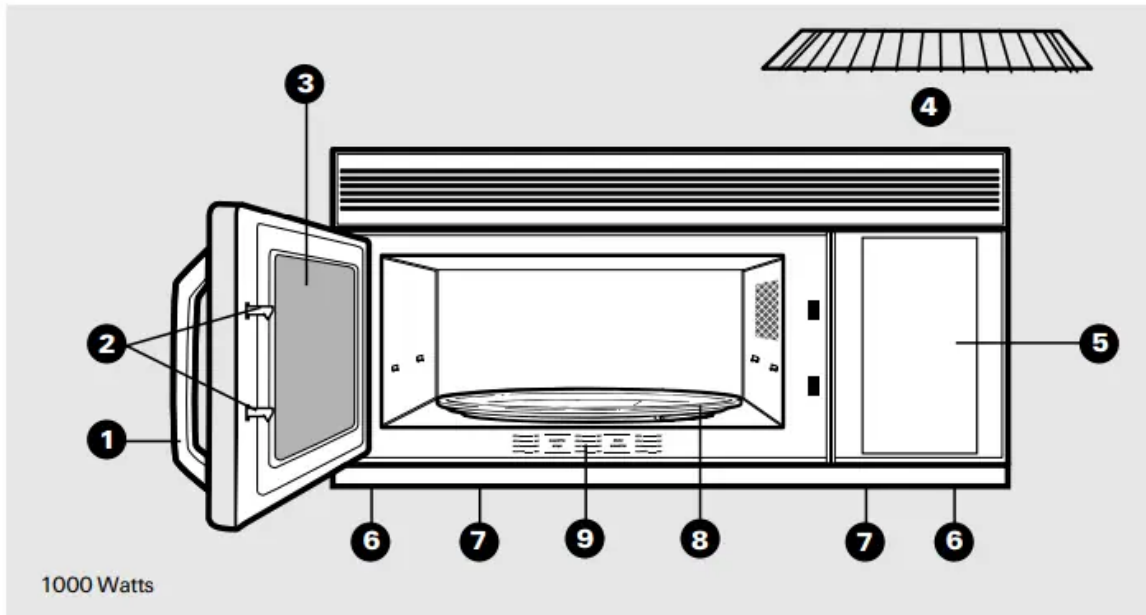

1. Door Handle. Pull to open the door. The door must be securely latched for the microwave to operate.
 2. Door Latches.
 3. Window with Metal Shield. Screen allows cooking to be viewed while keeping microwaves confined in the oven.
 4. Shelf. Lets you microwave several foods at once. Food microwaves best when placed directly on the oven floor or turntable.
 5. Touch Control Panel You must set the clock and calendar before using the microwave.
 6. Cooktop Lights.
 7. Grease Filters.
 8. Removable Turntable. Turntable and support must be in place when using the oven. The turntable may be removed for cleaning.
 9. Convenience Guide.
- NOTE:** Rating plate, oven vent(s) and oven light are located on the inside walls of the microwave oven.

Quick Start

The Controls on Your Microwave Oven

(Throughout this manual, features and appearance may vary from your model.)

You can microwave by time, temperature, or with the convenience features.

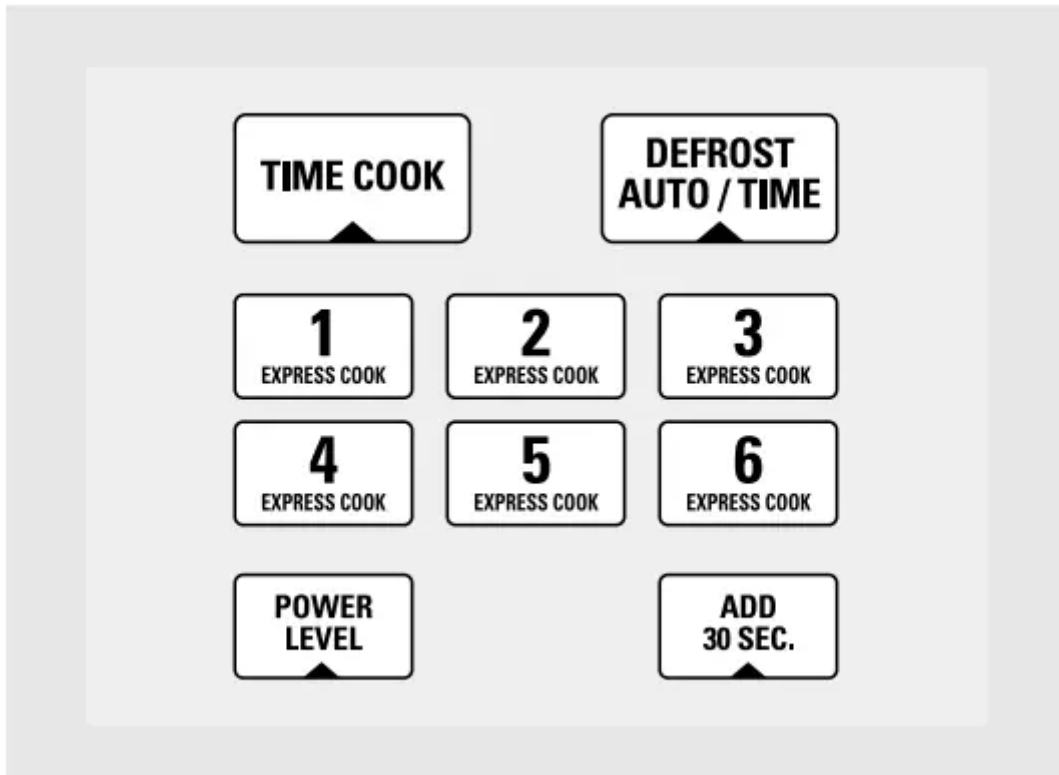

1. Time Features

Time Cooking

<i>Press</i>	<i>Enter</i>
TIME COOK I & II (Press once or twice)	Amount of cooking time.
DEFROST AUTO/TIME (Press twice)	Amount of defrosting time.
EXPRESS COOK	Starts immediately!
POWER LEVEL	Power level 1–10.
ADD 30 SEC	Starts immediately!

<p>HELP Press this pad and any feature pad for usage instructions and tips.</p>	<p>GUIDE ON MICROWAVE Before you begin, check the guide located on the inside front of the oven when you open the door.</p>	<p>GUIDES IN BOOK</p> <ul style="list-style-type: none"> • Cooking • Time Defrost • Reheat • Snacks
--	--	--

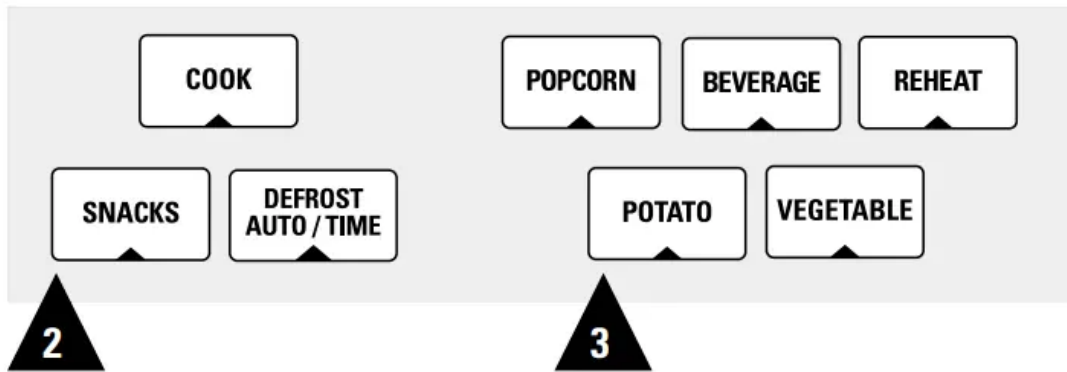

2. Convenience Features

<i>Press</i>	<i>Enter</i>	<i>Option</i>
COOK	Food type 1-9 + weight	
SNACKS	Snack type 1-6	number/weight
DEFROST AUTO/TIME (Press once)	Food weight	

3. Sensor Features

<i>Press</i>	<i>Enter</i>	<i>Option</i>
POPCORN	Starts immediately!	more/less time
BEVERAGE	Starts immediately!	
REHEAT	Starts immediately!	more/less time
POTATO	Starts immediately!	more/less time
VEGETABLE	Starts immediately!	more/less time
Press once (fresh vegetables)		more/less time
Press twice (frozen vegetables)		more/less time
Press three times (canned vegetables)		more/less time (on some models)

Changing Power Levels



How to Change the Power Level

The power level may be entered or changed immediately after entering the feature time for TIME COOK, TIME DEFROST or EXPRESS COOK. The power level may also be changed during time countdown.

1. Press TIME COOK or select Time Defrost.
2. Enter cooking or defrosting time.
3. Press POWER LEVEL.
4. Select desired power level 1–10.
5. Press START

Variable power levels add flexibility to microwave cooking. The power levels on the microwave oven can be compared to the surface units on a range. High (power level 10) or full power is the fastest way to cook and gives you 100% power. Each power level gives you microwave energy a certain percent of the time. Power level 7 is microwave energy 70% of the time. Power level 3 is energy 30% of the time.

A high setting (10) will cook faster but food may need more frequent stirring, rotating or turning over. Most cooking will be done on High (power level 10). A lower setting will cook more evenly and need less stirring or rotating of the food.

Some foods may have better flavor, texture or appearance if one of the lower settings is used. Use a lower power level when cooking foods that have a tendency to boil over, such as scalloped potatoes.

Rest periods (when the microwave energy cycles off) give time for the food to “equalize” or transfer heat to the inside of the food. An example of this is shown with power level 3— the defrost cycle. If microwave energy did not cycle off, the outside of the food would cook before the inside was defrosted. Here are some examples of uses for various power levels:

Power Level	Best Uses
High 10	Fish, bacon, vegetables, boiling liquids.
Med-High 7	Gentle cooking of meat and poultry; baking casseroles and reheating
Medium 5	5 Slow cooking and tenderizing such as stews and less tender cuts of meat.
Low 2 or 3	Defrosting without cooking; simmering; delicate sauces.
Warm 1	Keeping food warm without overcooking; softening butter.

Time Features

Time Cook





1. Press TIME COOK.
2. Enter cooking time.
3. Change power level if you don't want full power. (Press POWER LEVEL. Select a desired power level 1–10.)
4. Press START

Time Cook I

Allows you to microwave for any time up to 99 minutes and 99 seconds.

Power level 10 (High) is automatically set, but you may change it for more flexibility.

You may open the door during Time Cook to check the food. Close the door and press START to resume cooking

Time Cook II

Lets you change power levels automatically during cooking. Here's how to do it:

1. Press TIME COOK.
2. Enter the first cook time.

3. Change the power level if you don't want full power. (Press POWER LEVEL. Select a desired power level 1–10.)
4. Press TIME COOK again.
5. Enter the second cook time.
6. Change the power level if you don't want full power. (Press POWER LEVEL. Select a power level 1–10.)
7. Press START.

At the end of Time Cook I, Time Cook II counts down.

Cooking Guide for Time Cook I & II

NOTE: Use power level High (10) unless otherwise noted.

Vegetable	Amount	Time	Comments
Asparagus (fresh spears)	1 lb.	6 to 9 min., Med-High (7)	In 1½-qt. oblong glass baking dish, place 1/4 cup water.
(frozen spears)	10-oz. package	5 to 7 min.	In 1-qt. casserole.
Beans (fresh green)	1 lb. cut in half	9 to 11 min.	In 1½-qt. casserole, place 1/2 cup water.
(frozen green)	10-oz. package	6 to 8 min.	In 1-qt. casserole, place 2 tablespoons water.
(frozen lima)	10-oz. package	6 to 8 min.	In 1-qt. casserole, place 1/4 cup water.
Beets (fresh, whole)	1 bunch	17 to 21 min.	In 2-qt. casserole, place 1/2 cup water.
Broccoli (fresh cut)	1 bunch (1¼ to 1½ lbs.)	7 to 10 min.	In 2-qt. casserole, place 1/2 cup water.
(fresh spears)	1 bunch (1¼ to 1½ lbs.)	9 to 13 min.	In 2-qt. oblong glass baking dish, place 1/4 cup water.
(frozen, chopped)	10-oz. package	5 to 7 min.	In 1-qt. casserole.
(frozen spears)	10-oz. package	5 to 7 min.	In 1-qt. casserole, place 3 tablespoons water.
Cabbage (fresh)	1 medium head (about 2 lbs.)	8 to 11 min.	In 1½- or 2-qt. casserole, place 1/4 cup water.
(wedges)		7 to 10 min.	In 2- or 3-qt. casserole, place 1/4 cup water.
Carrots (fresh, sliced)	1 lb.	7 to 9 min.	In 1½-qt. casserole, place 1/4 cup water.
(frozen)	10-oz. package	5 to 7 min.	In 1-qt. casserole, place 2 tablespoons water.
Cauliflower (flowerets)	1 medium head	9 to 14 min.	In 2-qt. casserole, place 1/2 cup water.
(fresh, whole)	1 medium head	10 to 17 min.	In 2-qt. casserole, place 1/2 cup water.
(frozen)	10-oz. package	5 to 7 min.	In 1-qt. casserole, place 2 tablespoons water.

Vegetable	Amount	Time	Comments
Corn (frozen kernel)	10-oz. package	5 to 7 min.	In 1-qt. casserole, place 2 tablespoons water.
Corn on the cob (fresh)	1 to 5 ears	3 to 4 min. per ear	In 2-qt. oblong glass baking dish, place corn. If corn is in husk, use no water; if corn has been husked, add 1/4 cup water. Rearrange after half of time.
(frozen)	1 ear 2 to 6 ears	5 to 6 min. 3 to 4 min. per ear	Place in 2-qt. oblong glass baking dish. Cover with vented plastic wrap. Rearrange after half of time.
Mixed vegetables (frozen)	10-oz. package	5 to 7 min.	In 1-qt. casserole, place 3 tablespoons water.
Peas (fresh, shelled)	2 lbs. unshelled	9 to 12 min.	In 1-qt. casserole, place 1/4 cup water.
(frozen)	10-oz. package	5 to 7 min.	In 1-qt. casserole, place 2 tablespoons water.
Potatoes (fresh, cubed, white)	4 potatoes (6 to 8 oz. each)	9 to 12 min.	Peel and cut into 1 inch cubes. Place in 2-qt. casserole with 1/2 cup water. Stir after half of time.
(fresh, whole, sweet or white)	1 (6 to 8 oz.)	3 to 4 min.	Pierce with cooking fork. Place in center of the oven. Let stand 5 minutes.
Spinach (fresh)	10 to 16 oz.	5 to 7 min.	In 2-qt. casserole, place washed spinach.
(frozen, chopped and leaf)	10-oz. package	5 to 7 min.	In 1-qt. casserole, place 3 tablespoons water.
Squash (fresh, summer and yellow)	1 lb. sliced	5 to 7 min.	In 1½-qt. casserole, place 1/4 cup water.
(winter, acorn butternut)	1 to 2 squash (about 1 lb. each)	8 to 11 min.	Cut in half and remove fibrous membranes. In 2-qt. oblong glass baking dish, place squash cut-side-down. Turn cut-side-up after 4 minutes.

Time Defrost



1. Press DEFROST AUTO/TIME twice.
2. Enter defrosting time.
3. Press START.
4. Turn food over when the oven signals.
5. Press START.

(Auto Defrost explained in the section on Convenience Features.)

Allows you to defrost for the length of time you select. See the Defrosting Guide for suggested times.

Power level 3 is automatically set, but you may change this for more flexibility. You may defrost small items more quickly by raising the power level after entering the time. However, they will need more frequent attention than usual.

Power level 7 cuts the total defrosting time in about half; power level 10 cuts the total time to approximately 1/3. Rotate or stir food frequently.

At one half of selected defrosting time, the oven signals TURN. At this time, turn food over and break apart or rearrange pieces for more even defrosting. Shield any warm areas with small pieces of foil.

A dull thumping noise may be heard during defrosting. This sound is normal when the oven is not operating at High power.

Defrosting Tips

- Foods frozen in paper or plastic can be defrosted in the package. Tightly closed packages should be slit, pierced or vented AFTER food has partially defrosted. Plastic storage containers should be at least partially uncovered.
- Family-size, prepackaged frozen dinners can be defrosted and microwaved. If the food is in a foil container, transfer it to a microwave-safe dish.
- Foods that spoil easily, such as milk, eggs, fish, stuffings, poultry and pork, should not be allowed to sit out for more than one hour after defrosting. Room temperature promotes the growth of harmful bacteria.
- For more even defrosting of larger foods, such as beef, lamb and veal roasts, use Auto Defrost.
- Be sure large meats are completely defrosted before cooking.
- When defrosted, food should be cool but softened in all areas. If still slightly icy, return to the microwave very briefly, or let it stand a few minutes.

Defrosting Guide

Food	Time	Comments
Breads, Cakes <i>Bread, buns or rolls</i> (1 piece) <i>Sweet rolls</i> (approx. 12 oz.)	1 min. 3 to 5 min.	
Fish and Seafood <i>Fillets, frozen</i> (1 lb.) <i>Shellfish, small pieces</i> (1 lb.)	6 to 8 min. 5 to 7 min.	Place block in casserole. Turn over and break up after half the time.
Fruit <i>Plastic pouch—1 to 2</i> (10-oz. package)	3 to 6 min.	
Meat <i>Bacon</i> (1 lb.) <i>Franks</i> (1 lb.) <i>Ground meat</i> (1 lb.) <i>Roast: beef, lamb, veal, pork</i> <i>Steaks, chops and cutlets</i>	2 to 5 min. 2 to 5 min. 5 to 7 min. 12 to 16 min. per lb. 5 to 7 min. per lb.	Place unopened package in oven. Let stand 5 minutes after defrosting. Place unopened package in oven. Microwave just until franks can be separated. Let stand 5 minutes, if necessary, to complete defrosting. Turn meat over after half the time. Use power level 1. Place unwrapped meat in cooking dish. Turn over after half the time and shield warm areas with foil. When finished, separate pieces and let stand to complete defrosting.
Poultry <i>Chicken, broiler-fryer cut up</i> (2½ to 3 lbs.) <i>Chicken, whole</i> (2½ to 3 lbs.) <i>Cornish hen</i> <i>Turkey breast</i> (4 to 6 lbs.)	15 to 19 min. 17 to 21 min. 7 to 13 min. per lb. 5 to 9 min. per lb.	Place wrapped chicken in dish. Unwrap and turn over after half the time. When finished, separate pieces and microwave 2 to 4 minutes more, if necessary. Let stand to finish defrosting. Place wrapped chicken in dish. After half the time, unwrap and turn chicken over. Shield warm areas with foil. Finish defrosting. If necessary, run cold water in the cavity until giblets can be removed. Place unwrapped hen in the oven breast-side-up. Turn over after half the time. Run cool water in the cavity until giblets can be removed. Place unwrapped breast in dish breast-side-down. After half the time, turn over and shield warm areas with foil. Finish defrosting. Let stand 1 to 2 hours in refrigerator to complete defrosting.

Express Cook



This is a quick way to set cooking time for 1–6 minutes.

Press one of the Express Cook pads (from 1 to 6) for 1 to 6 minutes of cooking at power level 10. For example, press the 2 pad for 2 minutes of cooking time.

The power level can be changed as time is counting down. Press POWER LEVEL and enter 1–10.

Add 30 Seconds



You can use this feature two ways:

- It will add 30 seconds to the time counting down each time the pad is pressed.
- It can be used as a quick way to set 30 seconds of cooking time.

Convenience Features

Snacks



The Snacks feature automatically sets the microwaving times and power levels to warm a variety of snack foods.

1. Press SNACKS.
2. Select snack type 1–6 (see the Snacks Guide below).
3. Enter the number of items or the food weight in ounces.
4. Press START.

Hint: You can press and hold the SNACKS pad during cooking to display the snack type and remaining microwaving time.

Snacks Guide

Food Type	Quantity or Weight
1 Bread, rolls, muffins	1 to 4
2 Sandwiches	1 to 2
3 Pizza (leftover slices)	1 to 4
4 Dessert toppings	1 to 4
5 Soup	8 to 40 oz.
6 Cheese dip	4 to 16 oz.

Cook



The Cook feature automatically sets the cooking times and power levels for a variety of foods.

1. Press COOK.
2. Select food type 1–9 (see the Cook Guide below).

3. Enter weight in ounces.

4. Press START.

Hint: Press and hold the COOK pad during cooking to display the food type and remaining cook time.

Cook Guide

Food Type	Weight	Comments
1 Canned Vegetables	4 to 20 oz.	Use microwave-safe casserole or bowl. Cover with lid or vented plastic wrap.
2 Frozen Vegetables	4 to 20 oz.	Use microwave-safe casserole or bowl. Follow package instructions for adding water. Cover with lid or vented plastic wrap.
3 Fresh Vegetables	4 to 16 oz.	Use microwave-safe casserole or bowl. Add 2 tablespoons water for each serving. Cover with lid or vented plastic wrap.
4 Potatoes	8 to 40 oz.	Pierce skin with fork. Place potatoes on oven floor or turntable.
5 Fish	4 to 16 oz.	Use oblong, square or round dish. Cover with vented plastic wrap or wax paper.
6 Chicken Pieces	4 to 40 oz.	Use oblong, square or round dish. Cover with vented plastic wrap.
7 Ground Meat (beef, pork, turkey)	8 to 48 oz.	Use round casserole dish. Crumble meat into dish. Cover with lid or vented plastic wrap. Drain and stir at signal.
8 Bacon	2 to 10 oz.	Layer strips on a plate, 4 to a layer. Cover each layer with a paper towel.
9 Pizza (frozen, microwaveable)	4 to 16 oz.	Follow package instructions to prepare pizza for microwaving.

Auto Defrost



1. Press DEFROST AUTO/TIME once.
2. Using the Conversion Guide at right, enter food weight. For example, press pads 1 and 2 for 1.2 pounds (1 pound, 3 pounds)
3. Press START (Time Defrost is explained in the Time Features section)

The Defrost Auto/Time feature gives you two ways to defrost frozen foods. Press DEFROST AUTO/TIME once for Auto Defrost or twice for Time Defrost.

Use Auto Defrost for meat, poultry and fish up to 6 pounds. Use Time Defrost for most other frozen foods.

Auto Defrost automatically sets the defrosting times and power levels to give even defrosting results for meats, poultry and fish. There is a handy guide located on the inside front of the oven.

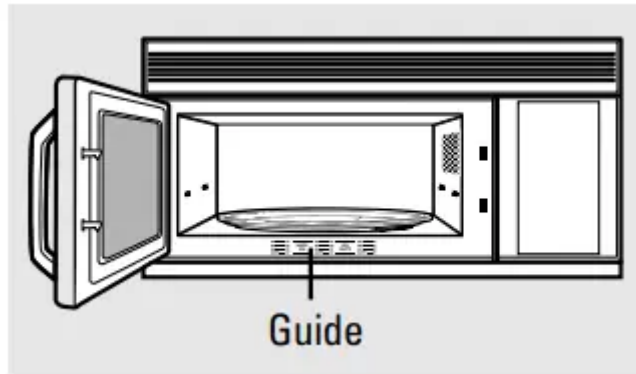

Conversion Guide

If the weight of food is stated in pounds and ounces, the ounces must be converted to tenths (.1) of a pound.

<i>Weight of Food in Ounces</i>	<i>Enter Food Weight (tenths of a pound)</i>
1-2	.1
3	.2
4-5	.3
6-7	.4
8	.5
9-10	.6
11	.7
12-13	.8
14-15	.9

- Remove meat from package and place on microwave-safe dish.
- Twice during defrost, the oven signals TURN. At each TURN signal, turn the food over. Remove defrosted meat or shield warm areas with small pieces of foil.

- After defrosting, most meats need to stand 5 minutes to complete defrosting. Large roasts should stand for about 30 minutes.

Sensor Features

What happens when using the Sensor Features...

The Sensor Features detect the increasing humidity released during cooking. The oven automatically adjusts the cooking time to various types and amounts of food.

Do not use the Sensor Features twice in succession on the same food portion—it may result in severely overcooked or burnt food. If food is undercooked after the countdown, use Time Cook for additional cooking time.

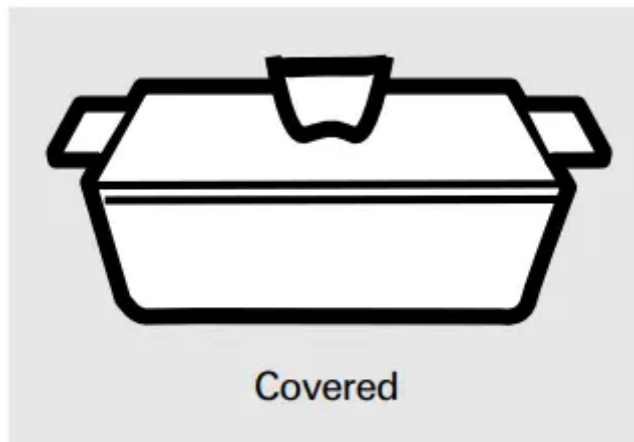

- The proper containers and covers are essential for best sensor cooking

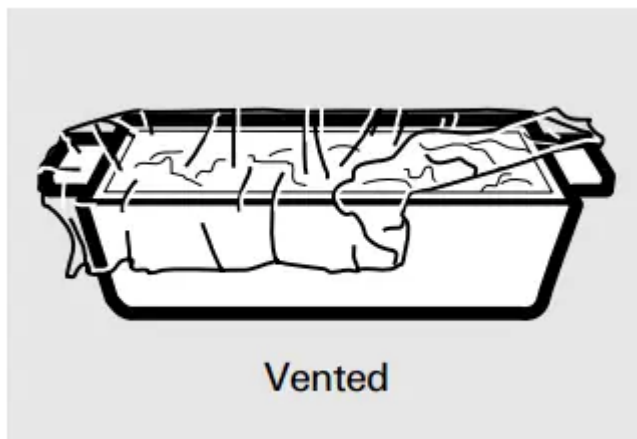

- Always use microwavesafe containers and cover them with lids or vented plastic wrap. Never use tight sealing plastic containers—they can prevent steam from escaping and

cause food to overcook.



- Be sure the outside of the cooking containers and the inside of the microwave oven are dry before placing food in the oven. Beads of moisture turning into steam can mislead the sensor.

Popcorn

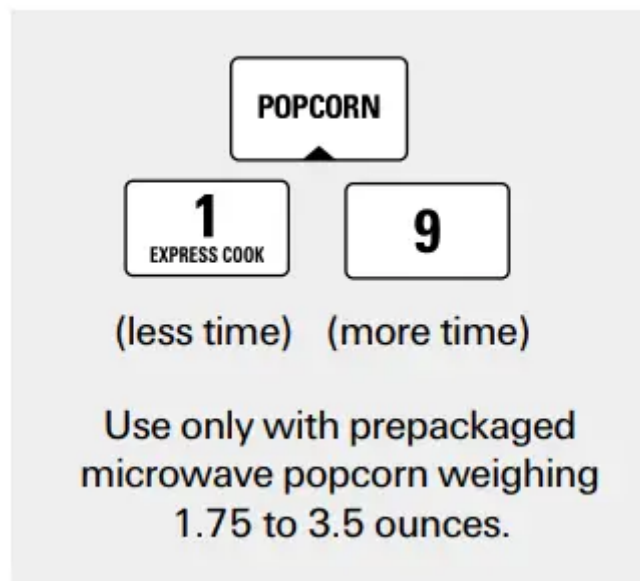

NOTE: Do not use the metal shelf when cooking popcorn.

NOTE: Do not use this feature twice in succession on the same food portion—it may result in severely overcooked or burnt food.

How to Use the Popcorn Feature

1. Follow package instructions, using Time Cook if the package is less than 1.75 ounces or larger than 3.5 ounces. Place the package of popcorn in the center of the microwave.
2. Press POPCORN. The oven starts immediately.

If you open the door while “POPCORN” is displayed, “SENSOR ERROR” will appear. Close the door, press CLEAR/OFF and begin again.

If food is undercooked after the countdown, use Time Cook for additional cooking time.

How to Adjust the Popcorn Program to Provide a Shorter or Longer Cook Time

If you find that the brand of popcorn you use underpops or overcooks consistently, you can add or subtract 20–30 seconds to the automatic popping time.

To add time:

After pressing POPCORN, press 9 immediately after the oven starts for an extra 20 seconds. Press 9 again to add another 10 seconds (total 30 seconds additional time).

To subtract time:

After pressing POPCORN, press 1 immediately after the oven starts for 20 seconds less cooking time.

Press 1 again to reduce cooking time another 10 seconds (total 30 seconds less time).

Beverage



NOTE: Do not use this feature twice in succession on the same food portion—it may result in severely overcooked or burnt food.

Press BEVERAGE to heat a cup of coffee or other beverage.

If food is undercooked after the countdown use Time Cook for additional cooking time.

Drinks heated with the Beverage feature may be very hot. Remove the container with care.

Reheat

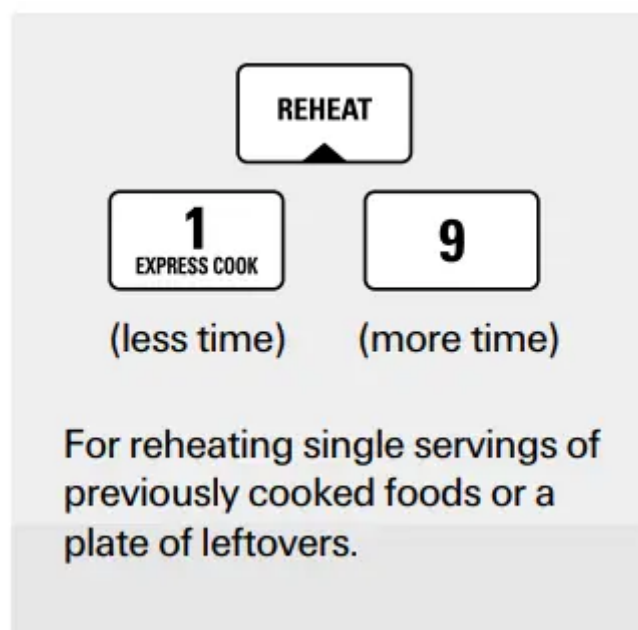

How to Change the Automatic Settings

To reduce time by 10%: Press 1 after the feature pad.

To add 10% to cooking time: Press 9 after the feature pad.

NOTE: Do not use the metal shelf when using the Reheat feature.

NOTE: Do not use this feature twice in succession on the same food portion—it may result in severely overcooked or burnt food.

How to Use the Reheat Feature

1. Place covered food in the oven. Press REHEAT. The oven starts immediately.
2. The oven signals when steam is sensed and the time remaining begins counting down.

Do not open the oven door until time is counting down. If the door is opened, close it and press START immediately.

After removing food from the oven, stir, if possible, to even out the temperature. Reheated foods may have wide variations in temperature. Some areas may be extremely hot.

If food is not hot enough after the countdown, use Time Cook for additional reheating time.

Some Foods Not Recommended For Use With Reheat

It is best to use Time Cook for these foods:

- Bread products.
- Foods that must be reheated uncovered.
- Foods that need to be stirred or rotated.
- Foods calling for a dry look or crisp surface after reheating

Sensor Cooking

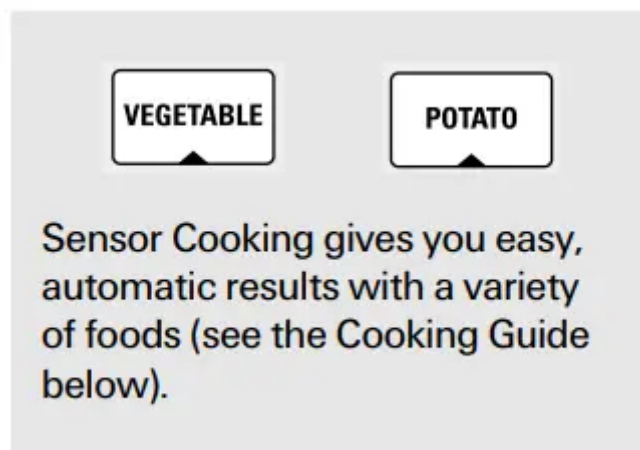

NOTE: Do not use the metal shelf with Sensor Cooking.

NOTE: Do not use this feature twice in succession on the same food portion—it may result in severely overcooked or burnt food.

Vegetable and Potato

- Place covered food in the oven. Press the food pad. (For vegetables, press the VEGETABLE pad once for fresh vegetables, twice for frozen vegetables, or three times for canned vegetables.) The oven starts immediately.
- The oven signals when steam is sensed and time remaining is counting down. Turn or stir the food if necessary.

Do not open the oven door until time is counting down. If the door is opened, close it and press START immediately.

If food is undercooked after the countdown, use Time Cook for additional cooking time.

How to Change the Automatic Settings (automatic settings for canned vegetables cannot be adjusted on some models)



You can adjust the cooking time for all foods to suit your personal taste.

Reduce time by 10%: Press 1 after the food pad.

Add 10% to cooking time: Press 9 after the food pad.

Cooking Guide

Food Type	Amount	Comments
Canned Vegetables	4–16 oz.	Cover with lid or vented plastic wrap.
Frozen Vegetables	4–16 oz.	Follow package instructions for adding water. Cover with lid or vented plastic wrap.
Fresh Vegetables	4–16 oz.	Add 1/4 cup water per serving. Cover with lid or vented plastic wrap.
Potatoes	1/2–2 lbs.	Pierce skin with fork. Place potatoes on the turntable.

Other Features Your Model May Have

Help



The HELP pad displays feature information and helpful hints. Press HELP, then select a feature pad.

Cooking Complete Reminder

To remind you that you have food in the oven, the oven will display “FOOD IS READY” and beep once a minute until you either open the oven door or press CLEAR/OFF.

Clock/Calendar

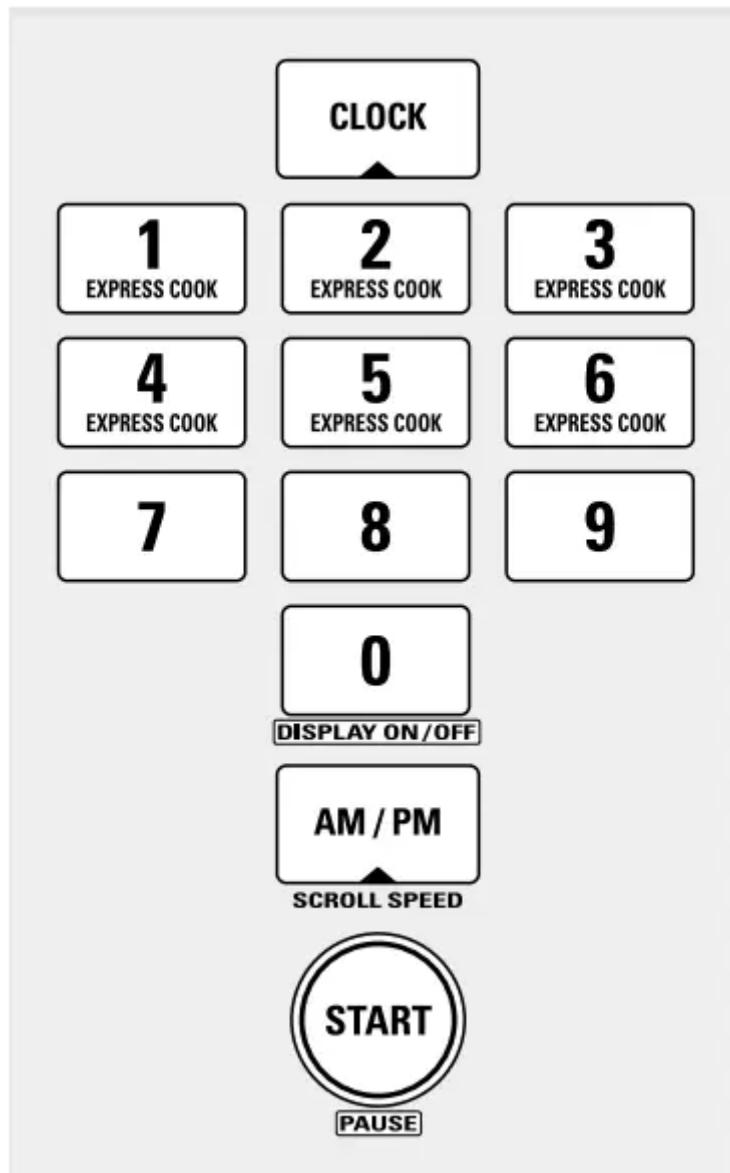

Press to enter the time of day or to check the time of day while microwaving.

1. Press CLOCK.
2. Enter time of day.
3. Select AM or PM.
4. Press START or CLOCK.
5. Enter the month, day and year. Example: 012303 (January 23, 2003)
6. Press START or CLOCK.

To check the time of day while microwaving, press CLOCK.

To check the date while microwaving, press and hold CLOCK for about three seconds.

Scroll Speed

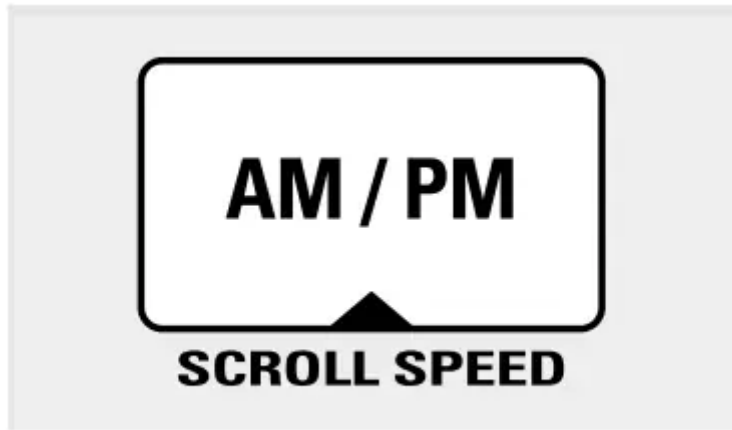

The scroll speed of the display can be changed. Press and hold the AM/PM pad about 3 seconds to bring up the display. Select 1–5 for slow to fast scroll speed.

Display On/Off



To turn the clock display off, press and hold 0 for about three seconds.

To redisplay the clock, repeat.

Delay Start



Delay Start allows you to set the microwave to delay cooking up to 24 hours.

1. Press DELAY START.
2. Enter the time you want the oven to start. (Be sure the microwave clock shows the correct time of day.)
3. Select AM or PM.
4. Select any combination of Defrost Auto/Time or Time Cook I & II.
5. Press START.

The Delay Start time will be displayed plus "DS." The oven will automatically start at the delayed time. The time of day may be displayed by pressing CLOCK.

Timer On/Off

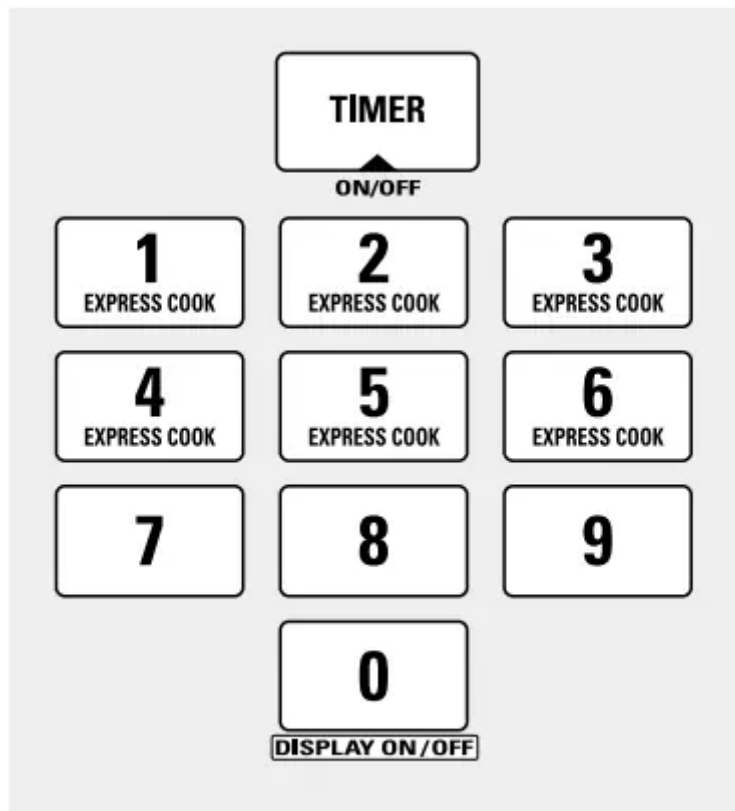

Timer On/Off operates as a minute timer and can be used at any time, even when the oven is operating.

1. Press TIMER ON/OFF.
2. Enter time you want to count down.
3. Press TIMER ON/OFF to start.

When time is up, the oven will signal. To turn off the timer signal, press TIMER ON/OFF.

NOTE: The timer indicator will be lit while the timer is operating.

Start/Pause



In addition to starting many functions, START/PAUSE allows you to stop cooking without opening the door or clearing the display

Reminder

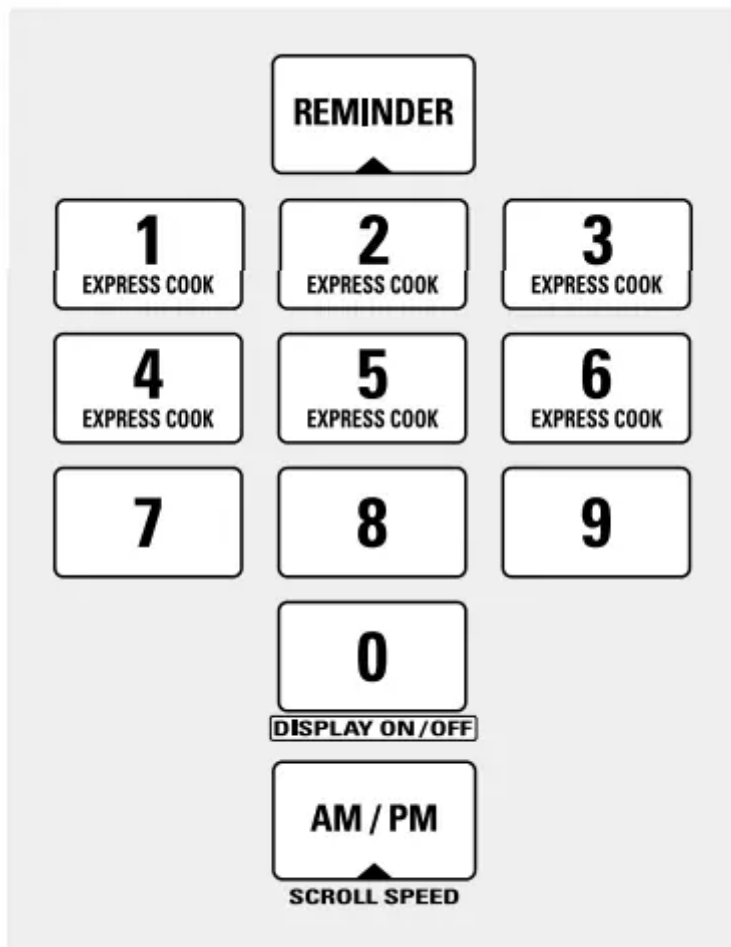

The Reminder feature can be used like an alarm clock and can be used at any time, even when the oven is operating. The Reminder time can be set up to 24 hours later.

1. Press REMINDER.
2. Enter the time you want the oven to remind you. (Be sure the microwave clock shows the correct time of day.)
3. Select AM or PM.
4. Press REMINDER. When Reminder signal occurs, press REMINDER to turn it off. The Reminder time may be displayed by pressing REMINDER.

NOTE: The REM indicator will remain lit to show that the Reminder is set. To clear the Reminder before it occurs, press REMINDER, then 0. The REM indicator will no longer be lit.

Child Lock-Out



You may lock the control panel to prevent the microwave from being accidentally started or used by children.

To lock or unlock the controls, press and hold CLEAR/OFF for about three seconds. When the control panel is locked, an "L" will be displayed to the extreme right.

Turntable



For best cooking results, leave the turntable on. It can be turned off for large dishes. Press TURNTABLE to turn the turntable on or off.

Sometimes the turntable can become too hot to touch. Be careful touching the turntable during and after cooking.

Vent Fan



The vent fan removes steam and other vapors from surface cooking

Press VENT FAN once for high fan speed, twice for low fan speed or a third time to turn the fan off.

Automatic Fan

An automatic fan feature protects the microwave from too much heat rising from the cooktop below it. It automatically turns on at low speed if it senses too much heat.

If you have turned the fan on you may find that you cannot turn it off. The fan will automatically turn off when the internal parts are cool. It may stay on for 30 minutes or more after the cooktop and microwave controls are turned off.

Surface Light



Press to turn the surface light on or off.

On some models, there is a night light option.

Press SURFACE LIGHT once for bright light, twice for the night light or three times to turn the light off.

Beeper Volume



The beeper sound level can be adjusted. Press BEEPER VOLUME. Choose 0–3 for mute to loud.

Auto Nite Light

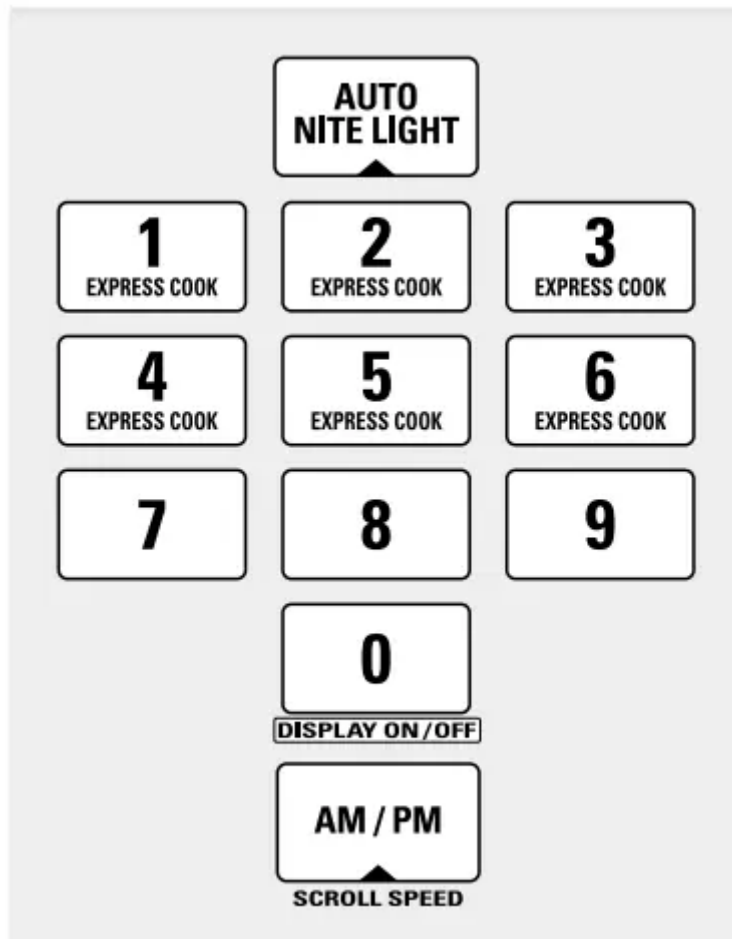

You can set the night light to turn on and off automatically at any time you want.

1. Press AUTO NITE LIGHT.
2. Enter the time you want the light to turn on. Select AM or PM.
3. Press AUTO NITE LIGHT again and enter the time you want the light to turn off. Select AM or PM.
4. Press AUTO NITE LIGHT.

NITE will stay lit to remind you that the feature is set. You can review the Auto Nite Light settings by pressing AUTO NITE LIGHT.

To erase your settings and turn off the automatic feature, press AUTO NITE LIGHT, then 0.

Shelf

How to Use the Shelf When Microwaving

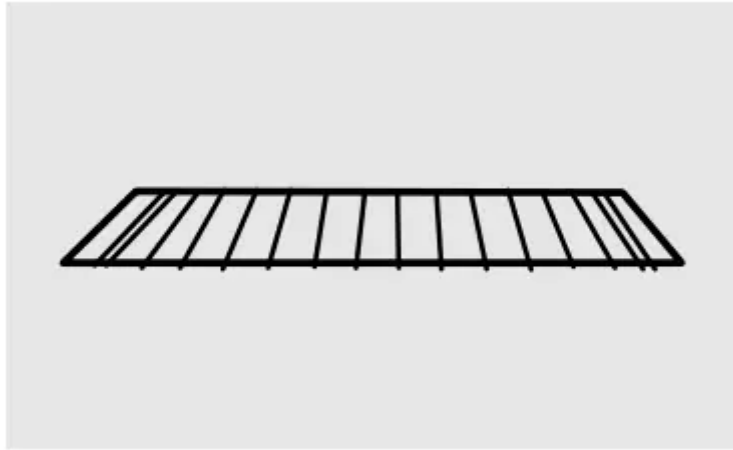

- Make sure the shelf is positioned properly inside the microwave to prevent damage to the oven from arcing.
- Do not use a microwave browning dish on the shelf. The shelf could overheat.
- Do not use the oven with the shelf on the microwave floor. This could damage the microwave.
- Use pot holders when handling the shelf— it may be hot.
- Do not use the shelf when cooking popcorn.
- Do not use the shelf with Sensor Cooking or Reheat.

Food microwaves best when placed on the turntable or on the shelf in the lower position.

Only use the shelf when reheating on more than one level. Do not store the shelf inside the oven cavity

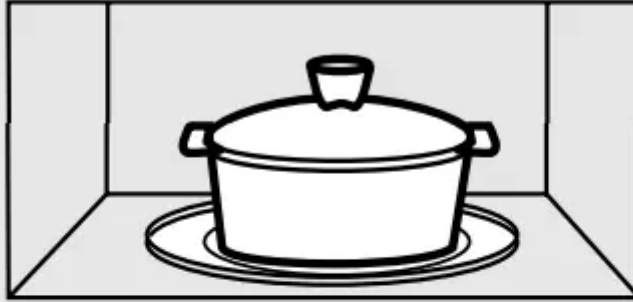

For best results

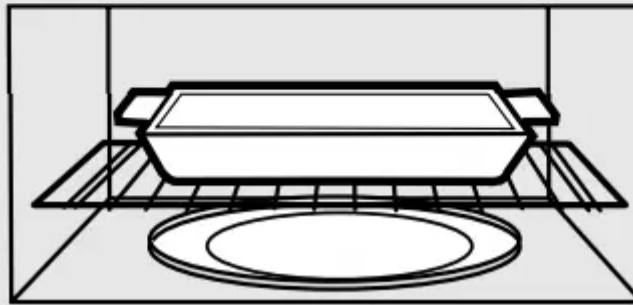

Uneven results

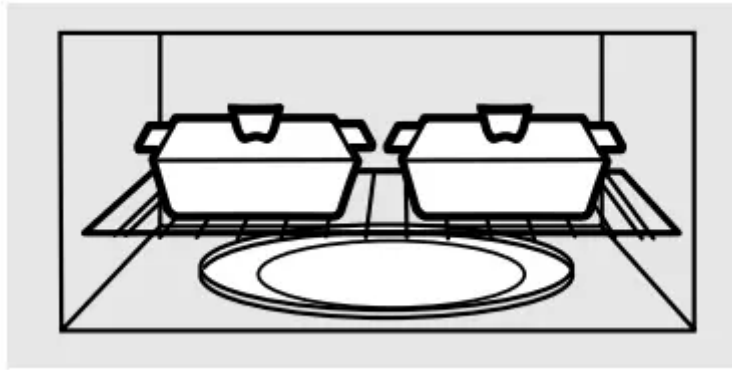

The shelf gives you the option to reheat more than one dish of food at the same time.

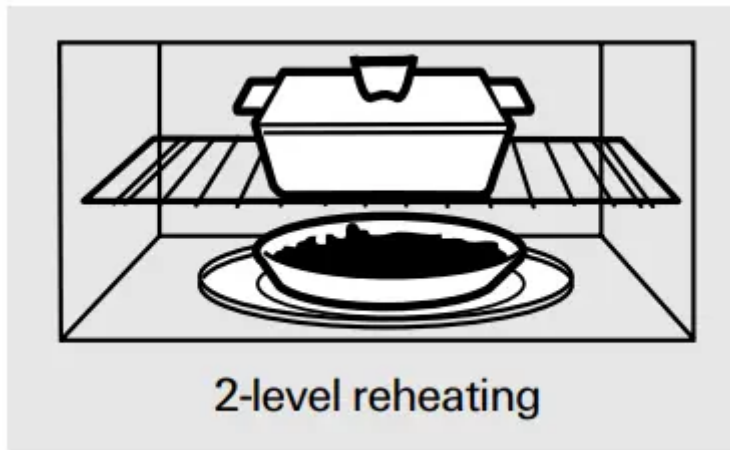

Shelf and Reheating

- To reheat on 2 levels

or

- To reheat 2 dishes on the lower level:

1. Multiply reheat time by 1 1/2.

2. Switch places after 1/2 the time.

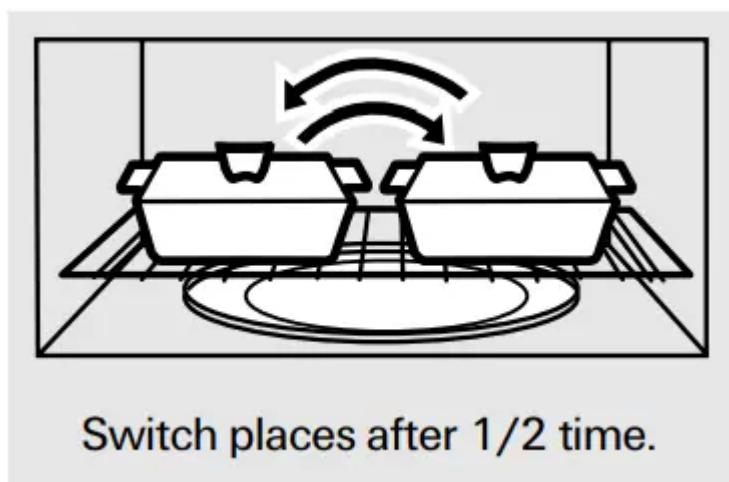
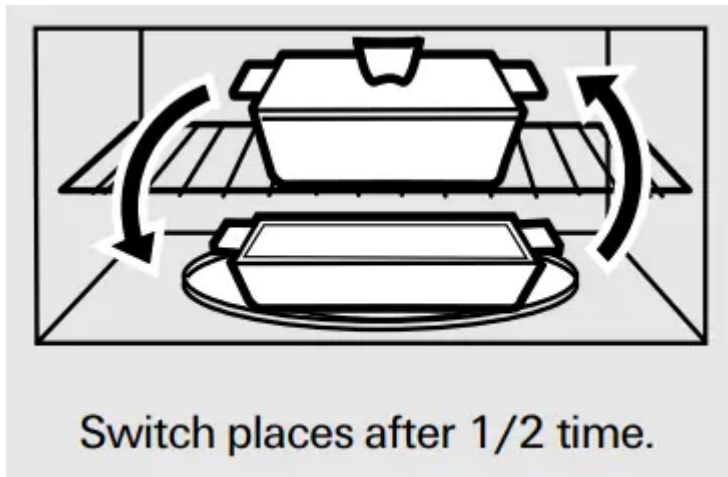

• **To reheat on 3 levels**

1. Double the reheating time.
2. Switch places twice and give the dishes a 1/2 turn during reheating. (Place dense foods, or those that require a longer cook time, on the upper shelf first.)

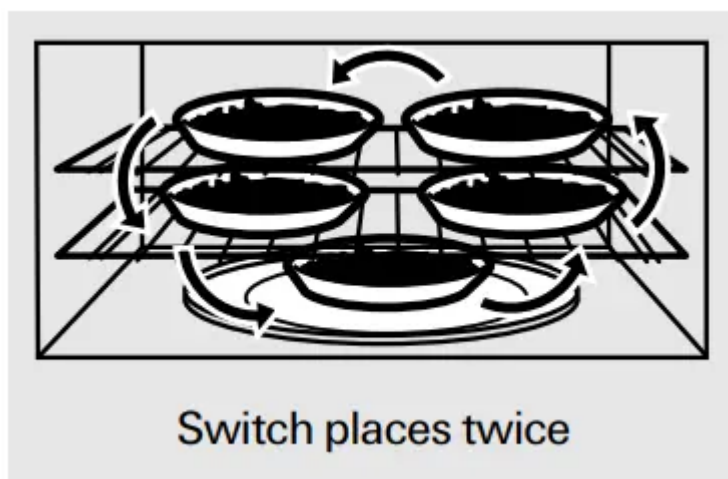

Helpful Information

Microwave Terms

Term	Definition
Arcing	Arcing is the microwave term for sparks in the oven. Arcing is caused by: <ul style="list-style-type: none">• the metal shelf being installed incorrectly and touching the microwave walls.• metal or foil touching the side of the oven.• foil that is not molded to food (upturned edges act like antennas).• metal such as twist ties, poultry pins, gold-rimmed dishes.• recycled paper towels containing small metal pieces.
Covering	Covers hold in moisture, allow for more even heating and reduce cooking time. Venting plastic wrap or covering with wax paper allows excess steam to escape.
Shielding	In a regular oven, you shield chicken breasts or baked foods to prevent over-browning. When microwaving, you use small strips of foil to shield thin parts, such as the tips of wings and legs on poultry, which would cook before larger parts.
Standing Time	When you cook with regular ovens, foods such as roasts or cakes are allowed to stand to finish cooking or to set. Standing time is especially important in microwave cooking. Note that a microwaved cake is not placed on a cooling rack.
Venting	After covering a dish with plastic wrap, you vent the plastic wrap by turning back one corner so excess steam can escape.

Care and Cleaning

Helpful Hints



An occasional thorough wiping with a solution of baking soda and water keeps the inside fresh.

NOTE: Be certain the power is off before cleaning any part of this oven.

How to clean the Inside

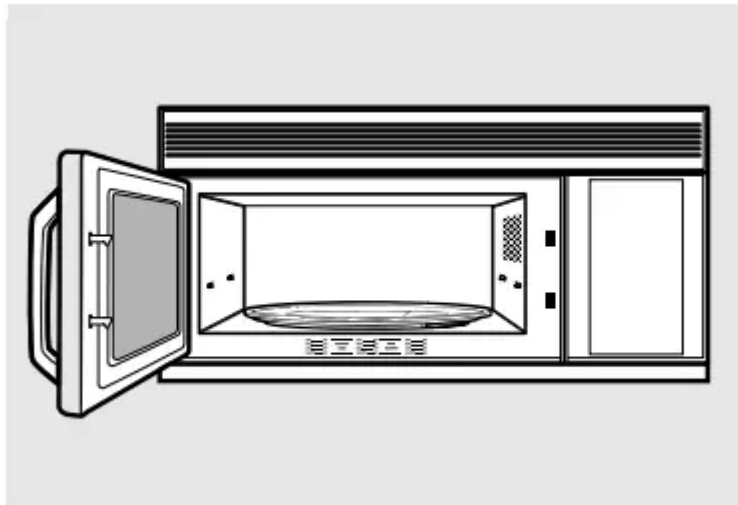

Walls, Floor, Inside Window, Metal and Plastic Parts on the Door

Some spatters can be removed with a paper towel, others may require a damp cloth. Remove greasy spatters with a sudsy cloth, then rinse with a damp cloth. Do not use abrasive cleaners or sharp utensils on oven walls. Never use a commercial oven cleaner on any part of your microwave.

Removable Turntable and Turntable Support

To prevent breakage, do not place the turntable into water just after cooking. Wash it carefully in warm, sudsy water or in the dishwasher. The turntable and support can be broken if dropped. Remember, do not operate the oven without the turntable and support in place.

Shelf

Clean with mild soap and water or in the dishwasher. Do not clean in a selfcleaning oven.

How to Clean the Outside

We recommend against using cleaners with ammonia or alcohol, as they can damage the appearance of the microwave oven. If you choose to use a common household cleaner, first apply the cleaner directly to a clean cloth, then wipe the soiled area.

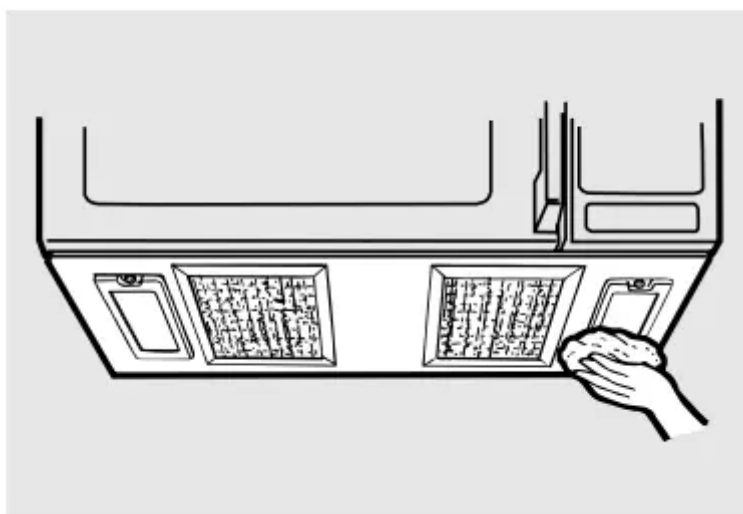

Case

Clean the outside of the microwave with a sudsy cloth. Rinse and then dry. Wipe the window clean with a damp cloth.

Control Panel and Door

Wipe with a damp cloth. Dry thoroughly. Do not use cleaning sprays, large amounts of soap and water, abrasives or sharp objects on the panel—they can damage it. Some paper towels can also scratch the control panel.

Door Seal

It's important to keep the area clean where the door seals against the microwave. Use only mild, non-abrasive detergents applied with a clean sponge or soft cloth. Rinse well.

Bottom

Clean off the grease and dust on the bottom often. Use a solution of warm water and detergent.

Stainless Steel Surfaces

Do not use a steel-wool pad; it will scratch the surface.

To clean stainless steel surfaces, use a hot, damp cloth with a mild detergent suitable for stainless steel surfaces. Use a clean, hot, damp cloth to remove soap. Dry with a dry, clean cloth.

If food soil remains, try a general kitchen cleaner, such as Fantastik,[®] Simple Green[®], or Formula 409.[®]

For hard-to-clean soil, use a standard stainless steel cleaner, such as Bon-Ami[®] or Cameo.[®]

Apply cleaner with a damp sponge. Use a clean, hot, damp cloth to remove cleaner. Dry with a dry, clean cloth. Always scrub lightly in the direction of the grain.

After cleaning, use a stainless steel polish, such as Stainless Steel Magic,[®] Revere Copper and Stainless Steel Cleaner,[®] or Wenol All Purpose Metal Polish.[®] Follow the product instructions for cleaning the stainless steel surface.

Light Bulb Replacement

Cooktop Light/ Night Light

Replace the burned-out bulb with a 40-watt incandescent bulb (WB36X10003), available from your GE supplier

1. To replace the bulb(s), first disconnect the power at the main fuse or circuit breaker panel or pull the plug.
2. Remove the screw at the front of the light cover and lower the cover.

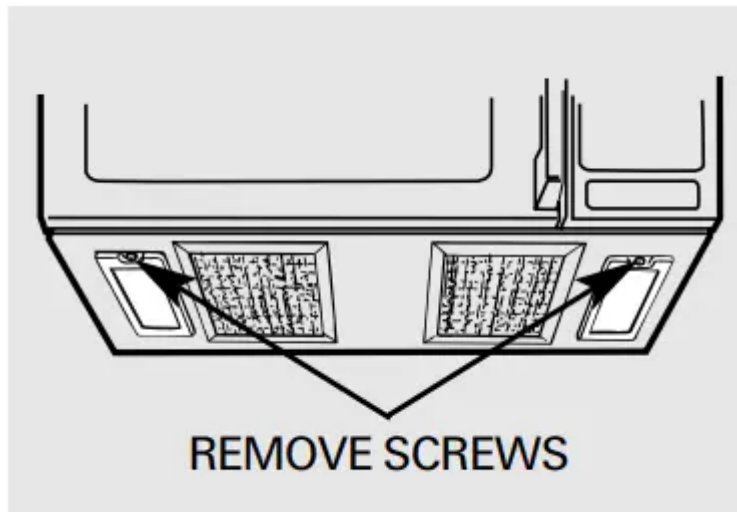

3. Be sure the bulb(s) to be replaced are cool before removing. After breaking the adhesive seal, remove the bulb by gently turning

4. Replace the screw. Connect electrical power to the oven.

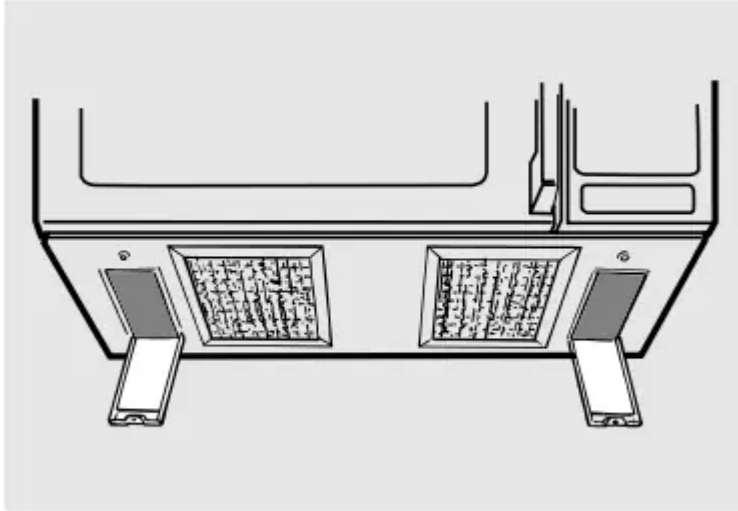

Oven Light

Replace the burned-out bulb with a 40-watt incandescent bulb (WB36X10003), available from your GE supplier.

1. To replace the oven light, first disconnect the power at the main fuse or circuit breaker panel or pull the plug.
2. Remove the top grille by taking out the 2 screws that hold it in place.

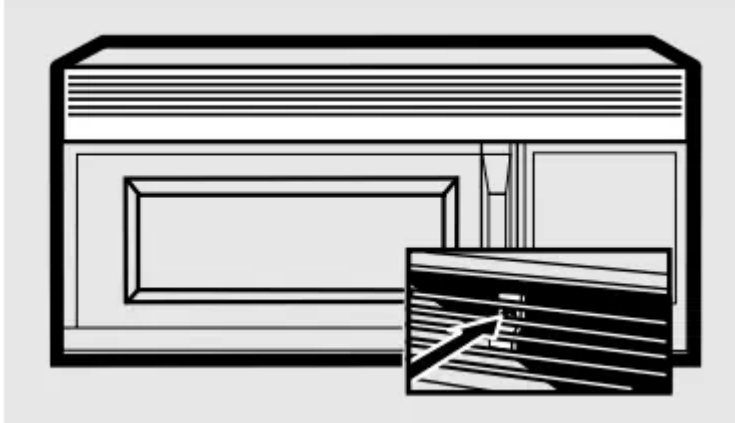

3. Next, remove the screw located above the door near the center of the oven that secures

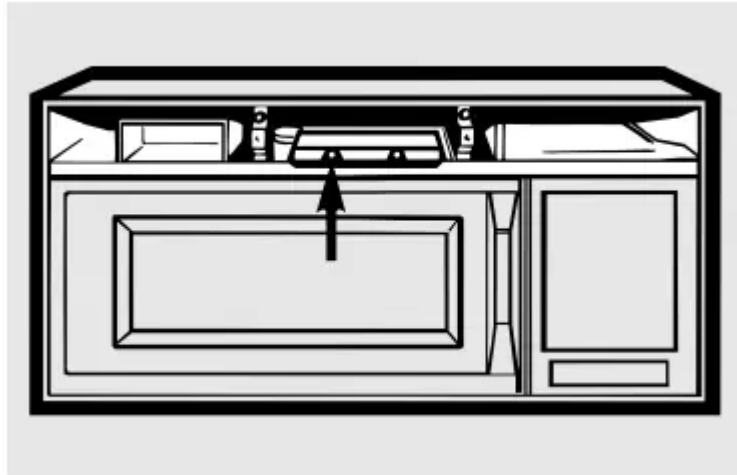

the light housing.

4. Replace the screw. Connect electrical power to the oven.

The Exhaust Feature

The Vent Fan

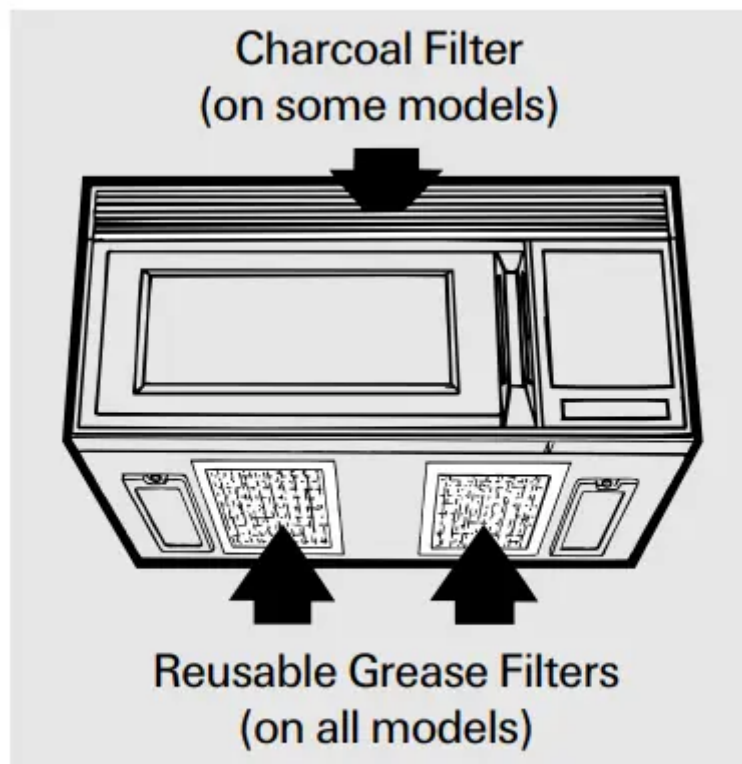

The vent fan has 2 metal reusable grease filters.

Models that recirculate air back into the room also use a charcoal filter.

Reusable Grease Filters

The metal filters trap grease released by foods on the cooktop. They also prevent flames from foods on the cooktop from damaging the inside of the microwave.

For this reason, the filters must ALWAYS be in place when the hood is used. The grease filters should be cleaned once a month, or as needed.

Removing and Cleaning the Filter

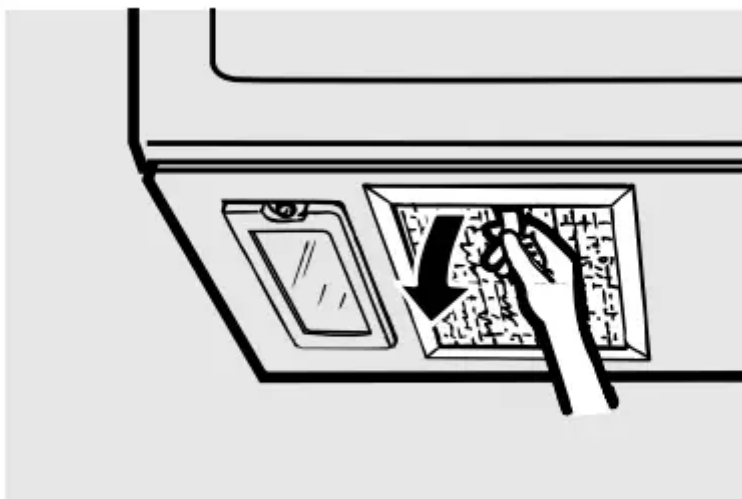

To remove, slide it to the rear using the tab. Pull it down and out.

To clean the grease filter, soak it and then swish it around in hot water and detergent. Don't use ammonia or ammonia products because they will darken the metal. Light brushing can be used to remove embedded dirt.

Rinse, shake and let it dry before replacing.

To replace, slide the filter in the frame slot on the back of the opening. Pull up and to the front to lock into place.

Charcoal Filter (on some models)

The charcoal filter cannot be cleaned. It must be replaced. Order Part No. WB02X9883 from your GE supplier.

If the model is not vented to the outside, the air will be recirculated through a disposable charcoal filter that helps remove smoke and odors.

The charcoal filter should be replaced when it is noticeably dirty or discolored (usually after 6–12 months, depending on hood usage).

To Remove Charcoal Filter

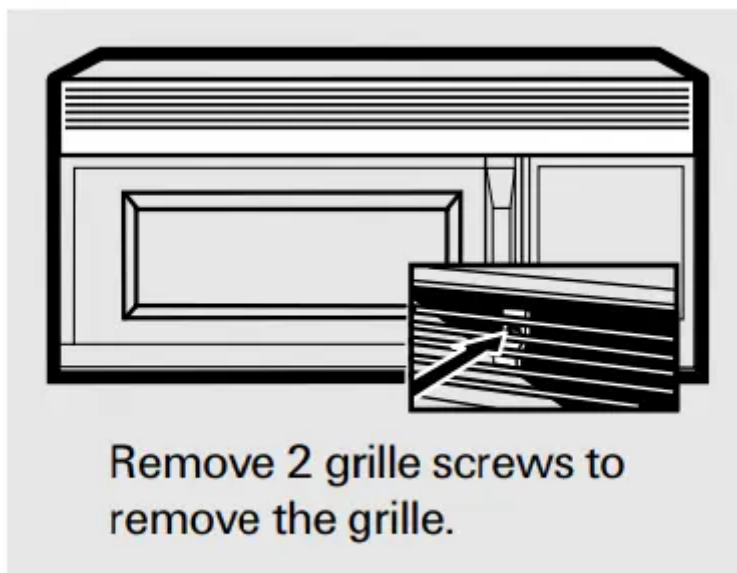

To remove the charcoal filter, disconnect power at the main fuse or circuit breaker panel or pull the plug.

Remove the top grille by removing the 2 screws that hold it in place. Slide the filter towards the front of the oven and remove it.

To Install Charcoal Filter

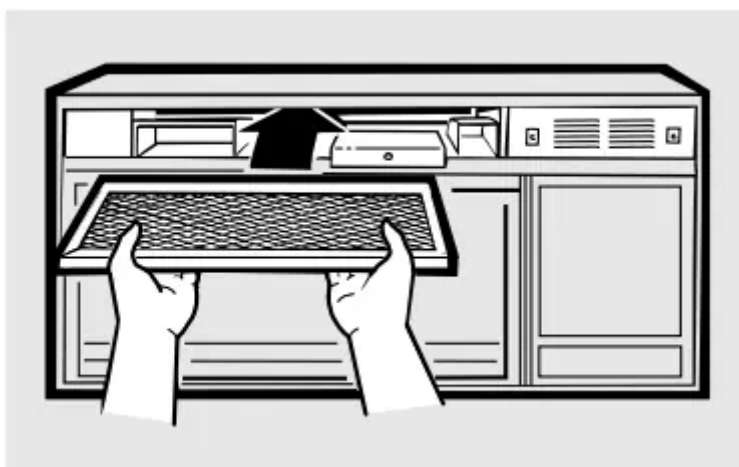

To install a new filter, remove plastic and other outer wrapping from the new filter.

Insert the filter into the top opening of the oven as shown. It will rest at an angle on 2 side support tabs and in front of the right rear tab. Replace the grille and 2 screws.

If Something Goes Wrong

Before You Call For Service



Problem	Possible Cause	What to Do
Oven will not start	<p>A fuse in your home may be blown or the circuit breaker tripped.</p> <p>Power surge.</p> <p>Plug not fully inserted into wall outlet.</p>	<ul style="list-style-type: none"> • Replace fuse or reset circuit breaker • Unplug the microwave oven, then plug it back in. • Make sure the 3-prong plug on the oven is fully inserted into wall outlet
Floor of the oven is warm, even when the oven has not been used	The cooktop light is located below the oven floor. When the light is on, the heat it produces may make the oven floor get warm.	<ul style="list-style-type: none"> • This is normal.
“LOCKED” appears on display	The control has been locked.	<ul style="list-style-type: none"> • Press and hold CLEAR/OFF for about 3 seconds to unlock the control.
You hear an unusual, low-tone beep	<p>You have tried to start the Reminder without a valid time of day.</p> <p>You have tried to start the Auto Nite Light without a valid time of day entered for the on-time and off-time.</p> <p>You have tried to change the power level when it is not allowed.</p>	<ul style="list-style-type: none"> • Start over and enter a valid time of day • Start over and enter a valid time of day • Many of the oven's features are preset and cannot be changed.
“SENSOR ERROR” appears on display	<p>When using a Sensor feature, the door was opened before steam could be detected.</p> <p>Steam was not detected in maximum amount of time.</p>	<ul style="list-style-type: none"> • Do not open door until steam is sensed and time is shown counting down on display

		<ul style="list-style-type: none"> • Use Time Cook to heat for more time.
Food amount too large for Sensor Reheat	Sensor Reheat is for single servings of recommended foods.	<ul style="list-style-type: none"> • Use Time Cook for large amounts of food.

Things That Are Normal

- Steam or vapor escaping from around the door.
- Light reflection around door or outer case.
- Dimming oven light and change in the blower sound at power levels other than high.
- Dull thumping sound while oven is operating.
- TV-radio interference might be noticed while using the microwave. Similar to the interference caused by other small appliances, it does not indicate a problem with the microwave. Plug the microwave into a different electrical circuit, move the radio or TV as far away from the microwave as possible, or check the position and signal of the TV/ radio antenna.

Warning

This content is compiled from multiple sources and is provided for reference purposes only. It may not be complete or fully applicable to all situations. If you are unable to resolve your issue, please contact the product manufacturer or an authorized service provider for official support.