

## Installation requirements

Read through the following instructions before installing the dryer, and keep this manual for future reference.

**WARNING:** Control board and inlet valve are intentionally not grounded and may present a risk of electric shock only during servicing. Service personnel - Do not contact this part while appliance is energized.

### Key installation requirements

- A grounded electrical outlet.
- A power cord for electric dryers (except in Canada).
- Gas lines (for gas models) that must meet national and local regulations.
- An exhaust system made of rigid metal or flexible stiff-walled metal exhaust ducting

**WARNING:** Remove the door from all discarded appliances to prevent a child from suffocating.

### Location considerations

- Adequate clearances between the dryer and adjacent walls or other surfaces.
- Adequate air circulation for ventilation and gas combustion.
- Away from water and weather.
- **WARNING:** Make sure to exhaust the dryer outdoors to reduce the risk of fire.
- Keep the dryer area clear of combustible materials, gasoline, and other flammable vapors and liquids.
- Do not install other fuel-burning appliances around or in the same place as the dryer.

Alcove or closet installation: Minimum clearances between the dryer and adjacent walls or other surfaces are: 2" in front, 17" on top, 1" on either side, and 5" in the back. The closet front must have two unobstructed air openings for a combined minimum total area of 72 in<sup>2</sup> with 3" minimum clearance on the top and bottom. A louvered door with equivalent space clearance is acceptable.

## Ducting requirements

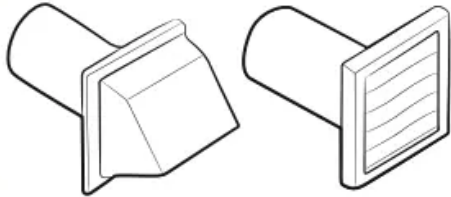
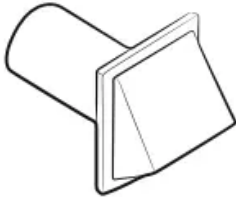
	Recommended		Use only for short-run installation	
Weather hood type	 4" (10.2 cm)		 2.5" (6.4 cm)	
No. of 90° elbows	Rigid	Metallic flexible*	Rigid	Metallic flexible*
0	80 ft. (24.4 m)	41 ft. (12.4 m)	74 ft. (22.6 m)	33 ft. (10.1 m)
1	68 ft. (20.7 m)	37 ft. (11.2 m)	62 ft. (18.9 m)	29 ft. (8.8 m)
2	57 ft. (17.4 m)	33 ft. (10.1 m)	51 ft. (15.5 m)	25 ft. (7.6 m)
3	47 ft. (14.3 m)	29 ft. (8.8 m)	41 ft. (12.5 m)	21 ft. (6.5 m)

NOTE: Use a 4-inch (10.2 cm) diameter rigid aluminum or galvanized steel duct

If you integrate the dryer's vent system with an existing exhaust system, make sure:

- The exhaust system meets all applicable local, state, and national regulations.
- Not to use a flexible plastic duct.
- To regularly check and clean all lint buildup from inside the existing ducts.
- The duct is not kinked or crushed.
- The exhaust hood damper opens and closes freely

Manometer measurements

- The static pressure in any exhaust system must not exceed 0.83 inches of water column or be less than 0. Note that these values are measured with the dryer running with a manometer presented to the exhaust duct that connects to the dryer. The dryer tumbler must be empty and lint filter clean.

## Exhausting requirements

The dryer must not be exhausted into a chimney, a wall, a ceiling, an attic, a crawl space, or a concealed space of a building. Exhausting the dryer to the outside will prevent large amounts of lint and moisture from being blown into the room.

In the United States and Canada

- All dryers must be exhausted to the outside.
- The required exhaust duct is 4 inches (10.2 cm) in diameter.
- See "Ducting requirements" in the "Installation" section for the maximum duct length and number of bends that can be used.

- The total length of flexible metal duct must not exceed 7' 10 1/2" (2.4 m).
- Do not assemble the duct with screws or other fastener means that extend into the duct and catch lint.
- For the United States only: Use only those foil-type flexible ducts, if any, specifically identified for use with the appliance by the manufacturer and that comply with the Outline for Clothes Dryer Transition Duct. Use Subject 2158A.

#### Outside the United States and Canada

- Refer to the local codes.
- **WARNING:** You must exhaust the dryer to the outside to reduce the risk of fire when you install the dryer in an alcove or closet.
- Do not use a plastic or non-metal flexible duct.
- If your existing ductwork is plastic, nonmetal, or combustible, replace it with metal.
- Use only a metal exhaust duct that is non-flammable to ensure containment of exhaust air, heat, and lint.

## Gas requirements

### WARNING

- Use only natural or LP (liquid propane) gases.
- **THE INSTALLATION MUST CONFORM WITH LOCAL CODES, OR IN THE ABSENCE OF LOCAL CODES, WITH THE NATIONAL FUEL GAS CODE ANSI/ Z223.1, LATEST REVISION (FOR THE UNITED STATES), OR WITH THE CAN / CGA-B149 INSTALLATION CODES (FOR CANADA).**
- Gas dryers are equipped with a burner vent for use with natural gas. If you plan to use your dryer with LP (liquid propane) gas, it must be converted for safe and proper performance by a qualified service technician.
- A 1/2" (1.27 cm) gas supply line is recommended and must be reduced to connect to the 3/8" (1 cm) gas line on your dryer. The National Fuel Gas Code requires that an accessible, approved manual gas shut-off valve be installed within 6" of your dryer.
- Gas dryers installed in residential garages must be raised 18 inches (46 cm) above the floor.
- Additionally, a 1/8" (0.3 cm) N.P.T. (National Pipe Thread) plugged tapping, accessible for test gauge connection, must be installed immediately upstream of your dryer's gas supply connection.
- Your dryer must be disconnected from the gas supply pipe system during any pressure testing of the system.

- Do not reuse old flexible metal gas lines. Flexible gas lines must be design certified by the American Gas Association (CGA in Canada).

#### NOTE

- Your dryer uses an automatic ignition system to ignite the burner. There is no constant burning pilot.
- Any pipe joint compound used must be resistant to the action of any liquefied petroleum gas.
- As a courtesy, most local gas utilities will inspect a gas appliance installation

Commonwealth of Massachusetts installation instructions: Your dryer must be installed by a licensed plumber or gas fitter. A “T” handle manual gas valve must be installed in the gas supply line to your dryer. If a flexible gas connector is used to install your dryer, the connector can be no longer than 3’ (36”). **WARNING:**

- Gas leaks may occur in your system, creating a dangerous situation.
- Gas leaks may not be detected by smell alone.
- Gas suppliers recommend you purchase and install a UL-approved gas detector.
- Install and use in accordance with the manufacturer's instructions.

## Electrical requirements

The wiring diagram is located on the plate under the control panel or rear frame. **WARNING:**

- Improperly connecting the equipment grounding conductor can result in a risk of electric shock. Check with a qualified electrician or serviceman if you are in doubt as to whether your dryer is properly grounded. Do not modify the plug provided with your dryer – if it doesn't fit the outlet, have a proper outlet installed by a qualified electrician.
- To prevent unnecessary risk of fire, electrical shock, or personal injury, all wiring and grounding must be done in accordance with local codes, or in the absence of local codes, in accordance with the National Electrical Code, ANSI/ NFPA No. 70-Latest Revision (for the U.S.) or the Canadian Electrical Code CSA C22.1 – Latest Revisions and local codes and ordinances. It is your responsibility to provide adequate electrical service for your dryer.
- All gas installations must be done in accordance with the national Fuel Code ANSI/ Z2231 – Latest Revision (for the U.S.) or CAN/CGA – B149 Installation Codes – Latest Revision (for Canada) and local codes and ordinances.

Grounding: This dryer must be grounded. In the event of malfunction or breakdown, the ground will reduce the risk of electrical shock by providing a path of least resistance for the electrical current. Gas models **WARNING:**

- Your dryer has a cord with an equipment-grounding conductor and a grounding plug. The plug must be plugged into an appropriate outlet that is properly installed and grounded in accordance with all local codes and ordinances.
- Do not modify the plug provided with your dryer – if it doesn't fit the outlet, have a proper outlet installed by a qualified electrician.
- Do not connect the ground wire to plastic plumbing lines, gas lines, or hot water pipes.

#### Electric models - **WARNING**

- Your dryer has an optional cord with an equipment-grounding conductor and a grounding plug. This cord is sold separately.
- The plug must be plugged into an appropriate outlet that is properly installed and grounded in accordance with all local codes and ordinances.
- Do not modify the plug provided with your dryer – if it doesn't fit the outlet, have a proper outlet installed by a qualified electrician.
- If a power cord is not used and the electric dryer is to be permanently wired, the dryer must be connected to a permanently grounded metal wiring system, or an equipment grounding conductor must be run with the circuit conductors and connected to the equipment grounding terminal or lead on the dryer.

#### Electrical connections

- Before operating or testing, follow all grounding instructions in the "Grounding" section. An individual branch (or separate) circuit serving only your dryer is recommended. Do not use an extension cord.

#### Gas models – U.S. and Canada

- A 120 volt, 60 Hz AC approved electrical service with a 15-ampere fuse or circuit breaker is required.

Electric models – U.S. only: Most U.S. dryers require a 120 / 240 volt, 60 Hz AC approved electrical service. Some require 120 / 208 volt, 60 Hz approved electrical service. The electric service requirements can be found on the data label located behind the door. A 30-ampere fuse or circuit breaker on both sides of the line is required.

- If a power cord is used, the cord should be plugged into a 30-ampere receptacle.
- The power cord is not provided with U.S. electric model dryers. This cord is sold separately

**WARNING - Risk of Electric Shock:** When local codes allow, you can connect the dryer's electrical supply with a new power supply cord kit, marked for use with a dryer, that is U.L.

listed and rated at a minimum of 120 / 240 volts, 30-amperes with three No. 10 copper wire conductors terminated with closed loop terminals, open-end spade lugs with turned up ends, or with tinned leads.

- Do not reuse a power supply cord from an old dryer. The power cord electric supply wiring must be supported at the dryer cabinet by a suitable UL-listed strain relief.
- Grounding through the neutral conductor is prohibited for (1) new branch-circuit installations, (2) mobile homes, (3) recreational vehicles, and (4) areas where local codes prohibit grounding through the neutral conductor. (Use a 4-prong plug for a 4 wire receptacle, NEMA type 14-30R.)

Electric models – Canada Only

- A 120 / 240 volt, 60 Hz AC approved electrical service fused through a 30-ampere fuse or circuit breaker on both sides of the line is required.
- All Canadian models are shipped with the power cord attached. The power cord should be plugged into a 30-ampere receptacle.

NOTE: In Canada, you may not convert a dryer to 208 volts.

## Installation

This dryer must be installed by a qualified technician. The installer is responsible for connecting the dryer to the main power while observing the relevant safety regulations of your area.

What's included

Make sure all the parts are included in the product package. If you have a problem with the dryer or the accessories, contact a local Samsung customer center or the retailer.

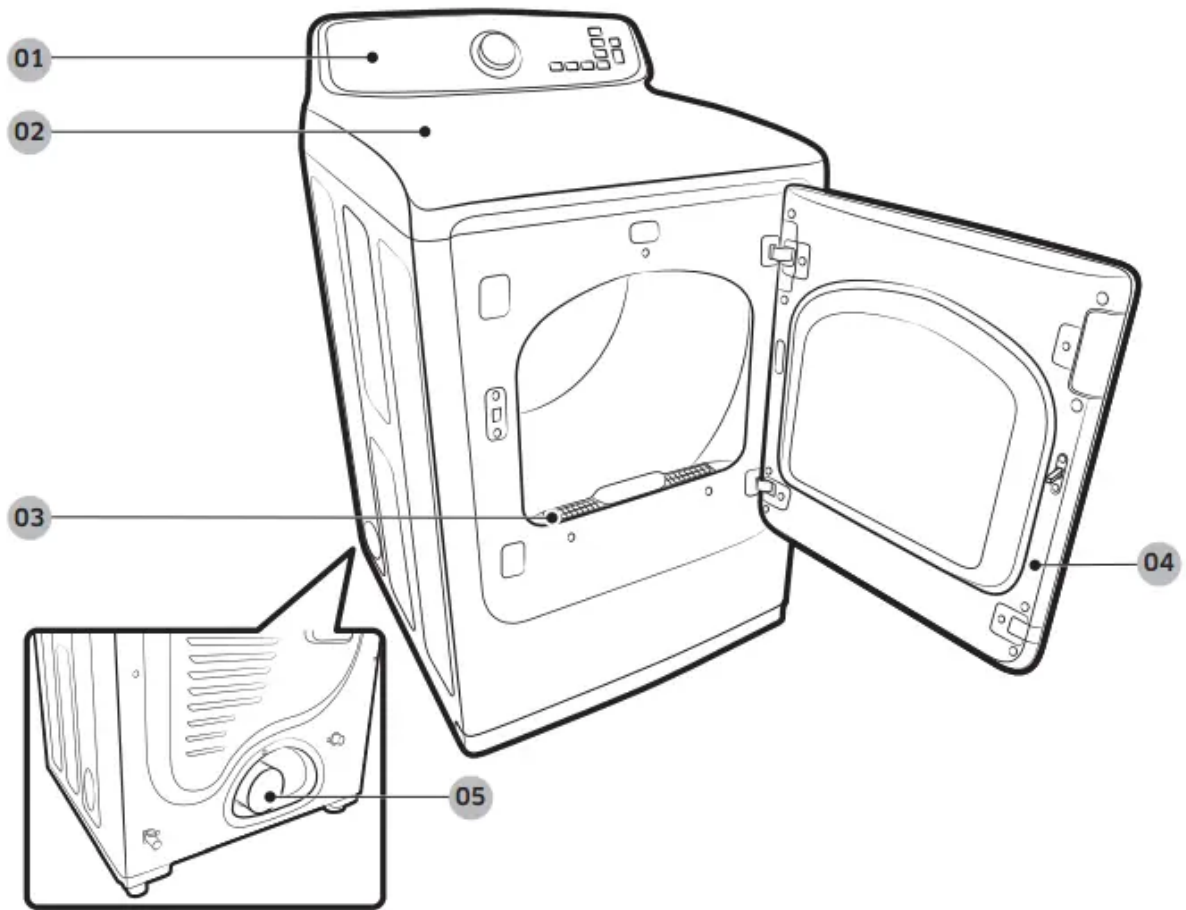

Dryer at a glance

- 01 Control panel
- 02 Worktop
- 03 Filter
- 04 Door
- 05 Exhaust duct

Accessories & tools

Provided accessories



Y connector

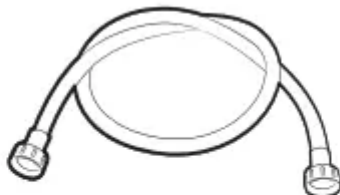

Water hose  
(Canadian models  
only)



Short water hose

## Required tools

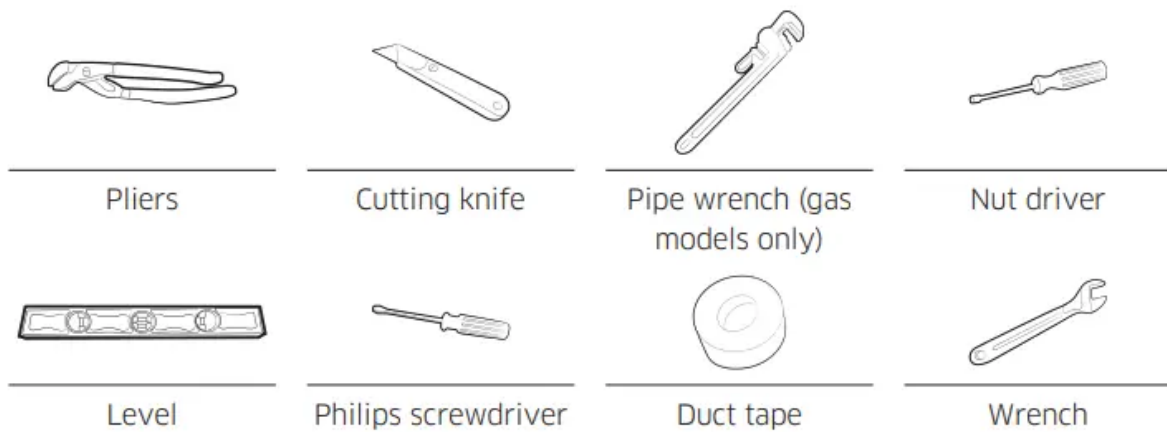

**WARNING:** Packing materials can be dangerous to children. Keep all packing materials (plastic bags, polystyrene, etc.) out of children's reach.

## Step-by-step installation

Make sure you have a qualified technician install the dryer. Step by step installation instructions start below

### STEP 1 Install the exhaust system

1. Select a location and move the dryer to the site. For easy access, we recommend you install the dryer in the same location as your washer.
2. To change the door direction, see "Switching the door position".
3. Install the exhaust system as instructed in the "Exhaust ducting guide" section.

### NOTE

- To move the dryer easily, lay two of the carton cushion-from the packaging on the floor. Tip the dryer on its side so it lies across both cushion-tops. Push the dryer so that it is near its final location, and then set the dryer upright.
- Secure room around the dryer to facilitate ducting and wiring.

**STEP 2** Connect the gas line - First, read through the "Gas requirements" section, and follow these steps.

1. Remove the protective cap from the gas pipe.
2. Apply a LPG (Liquefied Petroleum Gas)-safe compound or 1.5 wraps of Teflon tape to all threaded connections.
3. Connect the gas supply to the dryer. An additional fitting is required to connect the 3/4" (1.9 cm) female thread end of a flexible connector to the 3/8" (1 cm) male threaded end on the dryer. Tighten up the fitting over all threads.

4. Turn on the gas supply, and check for any leaks using a soap solution. If a leak is found, tighten the connections and try again. DO NOT use an open flame to check for gas leaks.

STEP 3 Connect the electrical wiring - First, read through the “Electrical requirements” section, and follow these steps

### 3-wire system

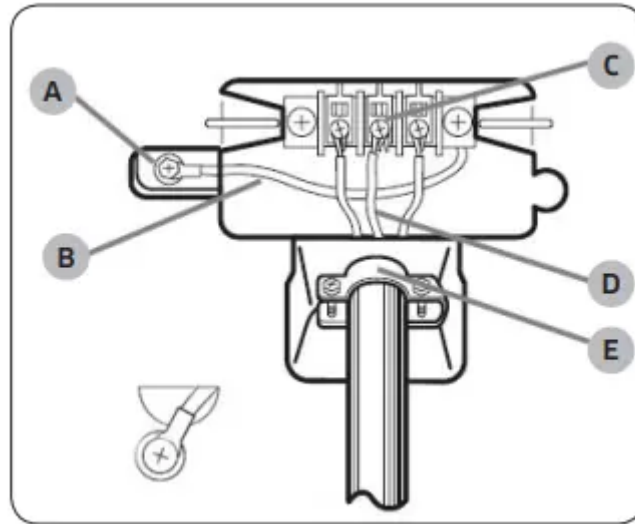

- A. External ground connector
- B. Neutral grounding wire (white)
- C. Center silver-colored terminal block screw
- D. Neutral wire (white or center wire)
- E. 3/4" (1.9 cm) UL-listed strain relief

1. Loosen or remove the center terminal block.
2. Connect the neutral wire (white or center wire) of the power cable to the center, silver-colored terminal screw of the terminal block. Tighten the screws.
3. Connect the other wires to outer terminal block screws. Tighten the screws.
4. Tighten the strain relief screws.
5. Insert the terminal block cover into the rear panel of the dryer. Then, secure the cover with a hold-down screw.

#### CAUTION

- To convert from the 4-wire system to 3-wire system, connect the ground strap to the terminal block support to ground the dryer frame to the neutral conductor.
- Ring-type terminals are recommended. If using strap terminals, make sure they are tightened.

## 4-wire system

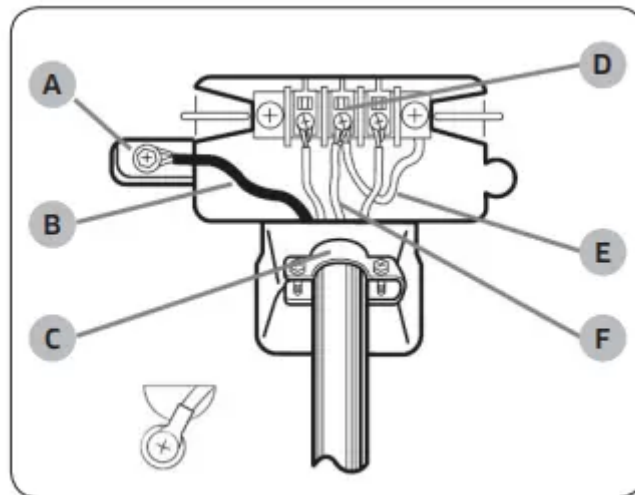

- A. External ground connector
- B. Green or bare copper wire of power cord
- C. 3/4" (1.9 cm) UL-listed strain relief
- D. Center silver-colored terminal block screw
- E. Neutral grounding wire (white)
- F. Neutral wire (white or center wire)

1. Remove the external ground connector's screw, and connect the ground wire (green or unwrapped) of the power cable to the screw. CAUTION: To connect the ground wire to the neutral position without through contact A (cabinet ground), contact a technician. This is not user serviceable. Ring-type terminals are recommended. If using strap terminals, make sure they are tightened.
2. Loosen or remove the screws from the center terminal block.
3. Connect the neutral wire (white or center wire) and ground wire (white) to the center screw of the terminal block. Tighten the screw.
4. Connect the other wires to the outer terminal block screws. Tighten the screws.
5. Tighten the strain relief screws.
6. Insert the tab of the terminal block cover into the rear slot of the dryer. Secure the cover with a hold-down screw

### WARNING

- All U.S. models are designed for a 3-wire system connection. The dryer frame is grounded to the neutral conductor at the terminal block. A 4-wire system connection is required for new or remodeled construction, mobile homes, or if local codes do not

permit grounding through neutral. If you use the 4-wire system, you cannot ground the dryer frame to the neutral conductor at the terminal block.

- Remove the terminal block cover plate. Insert the power cord with a UL-listed strain relief through the hole provided in the cabinet near the terminal block.
- A strain relief must be used. Do not loosen the nuts already installed on the terminal block. Be sure they are tight. Use a 3/8" (1 cm) deep well socket.

STEP 4 Connect the water hose - The dryer must be connected to a cold water tap using the provided water hoses.

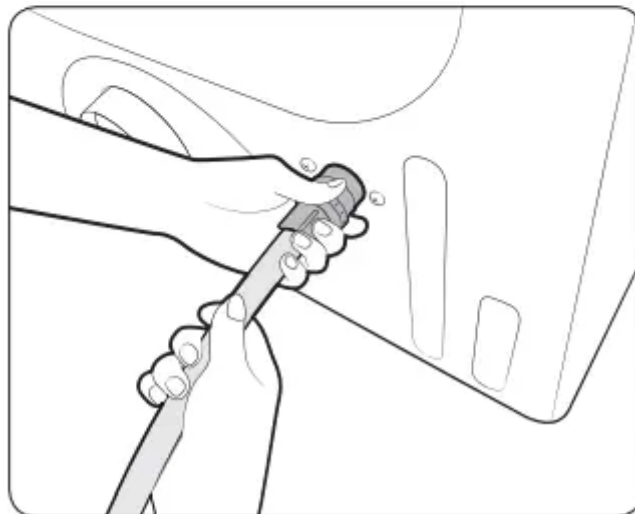
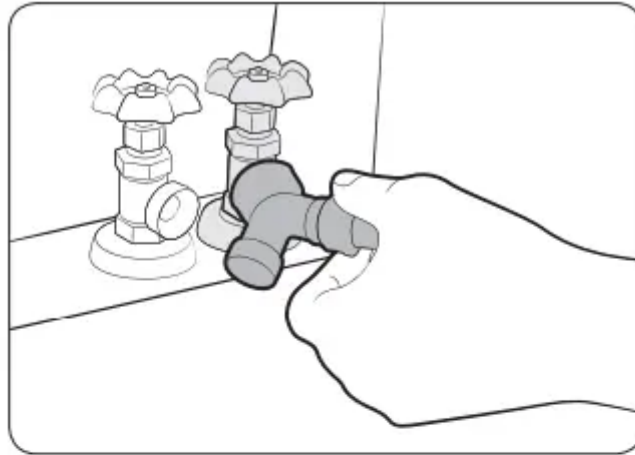

1. Close the cold water tap. If you have a washer cold water hose attached to the cold water faucet, unscrew and remove the hose. Then, connect the female end of the Y connector to the cold water tap.
2. Connect the straight end of the water hose to the Y connector.
3. Using pliers, tighten the coupling an additional two-thirds turn. Do not overtighten because the coupling may be damaged.

4. Connect the angled end of the water hose to the filling valve at the bottom of the rear frame. Turn the coupling manually until it is tight.
5. Using pliers, tighten the coupling an additional two-thirds turn. Do not overtighten because the coupling may be damaged.
6. If you detached the cold water hose from your washer, attach the hose to the open end of the Y connector, tighten the coupling until it is tight, and then, using a pliers, tighten an additional two-thirds turn.
7. Open the cold water tap, and then check for any leaks.

If the Y connector cannot be directly connected to the cold water tap, use the short hose as shown on the following page.

Using the short hose as an extension

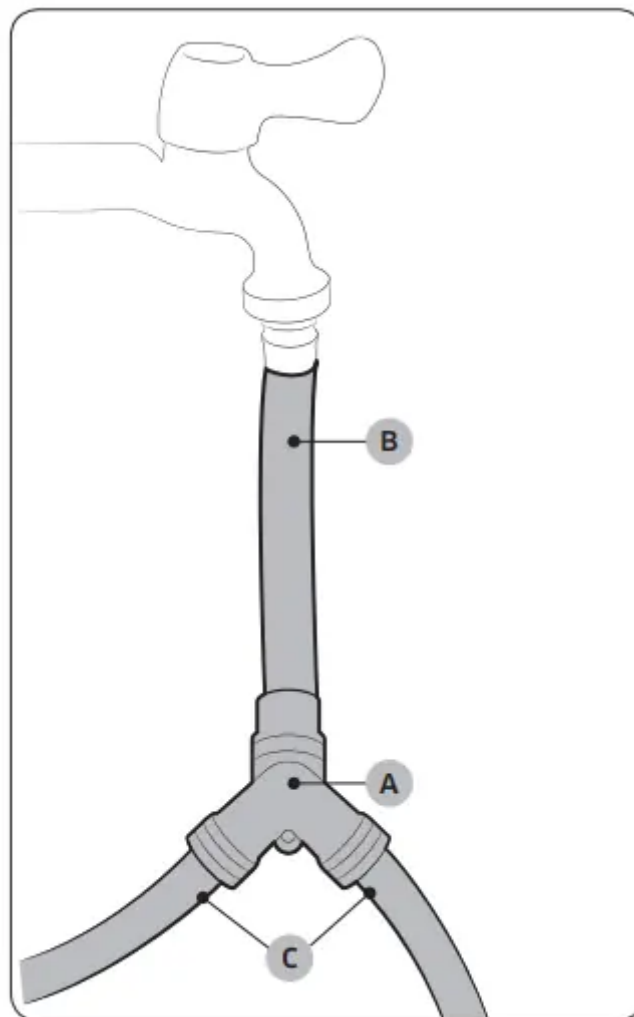

1. Close the cold water tap. If you have a washer cold water hose attached to the cold water faucet, unscrew and remove the hose. Then, connect the short hose (B) to the cold water tap. Turn the coupling manually until it is tight.

2. Using pliers, tighten the coupling an additional two-thirds turn. Do not overtighten because the coupling may be damaged.
3. Connect the Y connector (A) to the brass male end of the short hose. Turn the coupling manually until it is tight.
4. Using pliers, tighten the coupling an additional two-thirds turn. Do not overtighten because the coupling may be damaged.
5. Connect the angled end of the water hoses (C) to the filling valve at the bottom of the rear frame. Turn the coupling manually until it is tight.
6. Using pliers, tighten the coupling an additional two-thirds turn. Do not overtighten because the coupling may be damaged.
7. If you detached the cold water hose from your washer, attach the hose to the free end of the Y connector, tighten the coupling until it is tight, and then, using a pliers, tighten an additional two-thirds turn.
8. Open the cold water tap, and then check for any leaks.

STEP 5 Level the dryer - To ensure optimal performance, the dryer must be level.

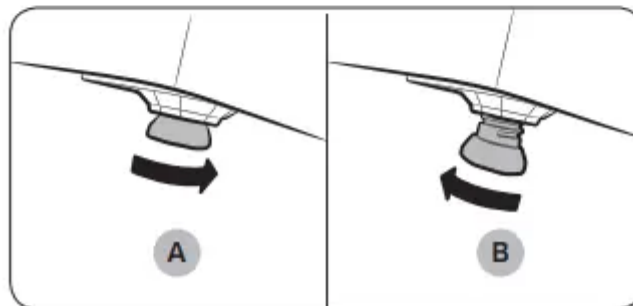
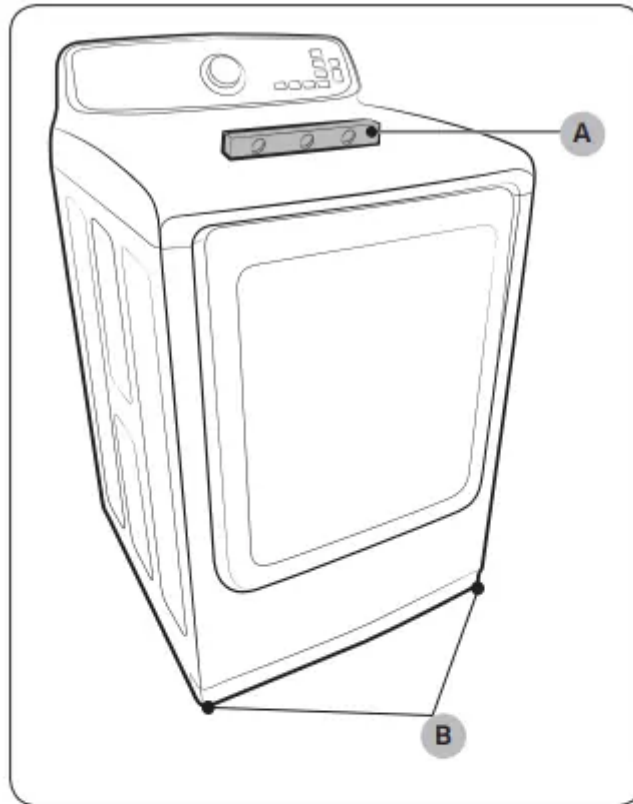

1. Using a level (A), check if the dryer is level side to side and then front to back. If the dryer is not level, adjust the leveling feet (B) at the bottom of the dryer. Then, check if the dryer is level again. NOTE: To set the dryer to the same height as your washer, fully retract (A) the leveling feet by turning them counterclockwise, then loosen (B) the feet by turning them clockwise. Once the dryer is the same height as the washer, follow the directions above to level the dryer. Adjust the leveling feet only as much as necessary to level the dryer. Extending the leveling feet more than necessary can cause the dryer to vibrate.

STEP 6 Power on (Gas models) - Make sure all gas connections, the exhaust line, and all wiring is connected correctly. Then, plug the power cord into a power source and check the dryer's installation and operation using the final checklist in Step 7 below.

STEP 7 Final check

When installation is complete, confirm that:

- The dryer is plugged into an electrical outlet and grounded properly.
- The exhaust ductwork is connected and the joints are taped.
- You have used rigid or stiff-walled flexible metal duct material, not plastic flexible duct.
- The dryer is level and is sitting firmly on the floor.
- The dryer starts, runs, heats, and shuts off properly.

For gas models:

- The gas is supplied properly with no leaks.

**CAUTION:** The burner may not ignite initially due to air in the gas line. Allowing your dryer to operate on a heat setting will purge the line. If the gas does not ignite within 5 minutes, turn your dryer off and wait 5 minutes. Be sure the gas supply to your dryer has been turned on. To confirm gas ignition, check the exhaust for heat.

### Vent blockage test

After the dryer is installed, start the Vent Blockage Test to check if the duct system is properly installed. The Vent Blockage Test automatically detects the status of the ducts and reports any blockage or problems. Proper ducting can reduce drying time and save energy.

**NOTE:** The Vent Blockage Test must run with the dryer in a cool state. If the dryer warms up after the installation check, run the AIR FLUFF cycle for several minutes to reduce its internal temperature.

### Running the vent blockage test

1. Make sure the drum is empty, and then close the door. (If there are any clothes or other items in the drum, the test will not give accurate results.)
2. Press the POWER button to turn the dryer on, then simultaneously press and hold the Adjust Time  and Dry Level buttons for 3 seconds. "InS or In" appears in the dryer's display. (If you have started other procedures before the Vent Blockage Test, the dryer will not enter the Vent Blockage Test mode.)
3. Press the START/PAUSE button. The Vent Blockage Test starts immediately. During the test, the number indicator makes a circle in 6 clockwise steps. The test takes about 2 minutes. Do not open the door during the test.
4. After 2 minutes, when the test is complete, the results is displayed and the dryer sounds a tone. If status of the duct system is normal, "End or 0" appears and the dryer sounds a completion tone. If the duct system can not exhaust properly, "CLg or Cg" appears and the dryer sounds an alarm tone. If there are any other problems, an information code appears in the display. For information about the code, see "Information codes" section. To stop or cancel the Vent Blockage Test, press the POWER button to turn off your dryer.

During the test, if “dc” appears in the display, make sure the door is closed. If “C1” is displayed, see if there is laundry inside drum. If there is, stop the test and remove it. Then, start the test again. The results remain on the display for about 5 minutes and then automatically turn off. You can turn the result off immediately by pressing the POWER button.

#### NOTE

- During or after the test, the internal drum is hot. Use caution to prevent burns. The Vent Blockage Test is used to check for problems to the current duct system when the dryer is installed for the first time.
- If the test result displays “CLg or Cg” (the duct system is blocked ), refer to the “Ducting requirements” section and the “Exhaust ducting guide” section below, and then take proper measures to correct any problems. If the test is suspended, it could result in incorrect results. Follow the proper procedures when testing the dryer.
- Even if the test result is normal (“End or 0”), the duct system could be blocked slightly. Properly install all duct work according to the installation instructions in this manual.

#### Exhaust ducting guide

##### Ducting

1. Make sure the dryer is installed properly so the air exhausts freely.
2. Use 4-inch rigid metal ducts. Tape all joints including the dryer connection. Never use lint-trapping screws.
3. To facilitate the exhaust, keep the ducts as straight as possible.

Cleaning: Clean all old ducts before installing the dryer, and make sure the vent flap opens and closes freely. We recommend that you to clean the exhaust system annually or on a regular basis. **WARNING**

- To prevent fire, do not use plastic, thin-foil, or non-metal flexible ducts of any kind.
- Do not use a poor exhaust system because it slows down the dryer’s performance.
- Do not use excessively long ducts that have multiple elbows.
- Do not use crushed or clogged venting or ducts.

##### Switching the door position

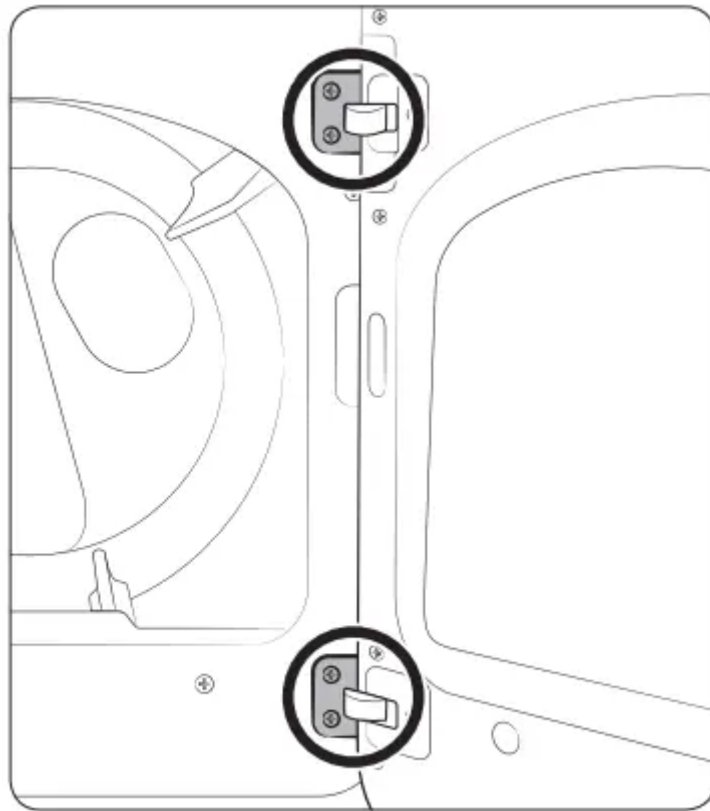

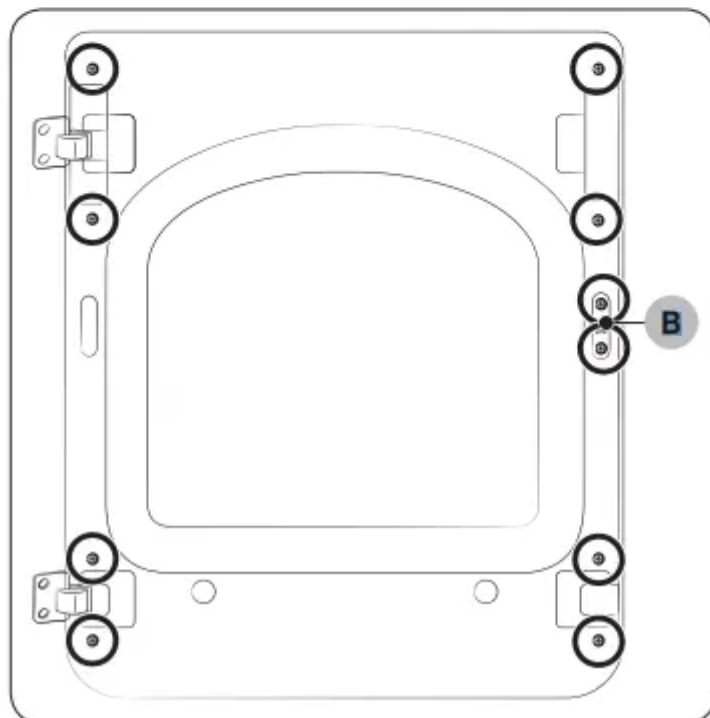
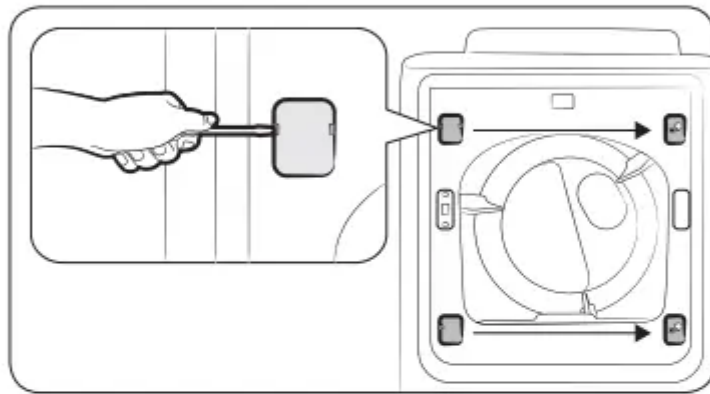
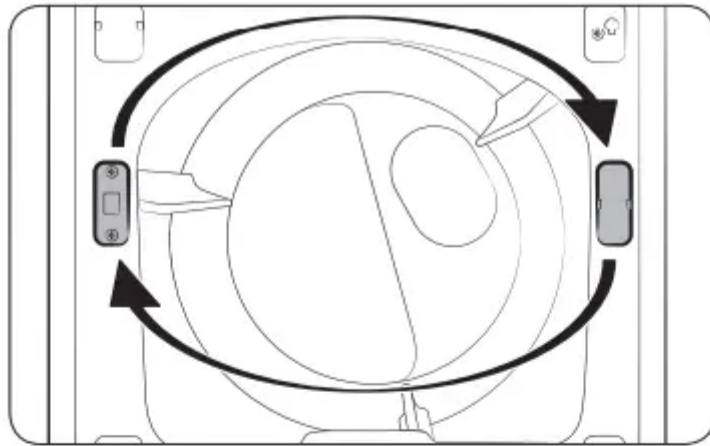

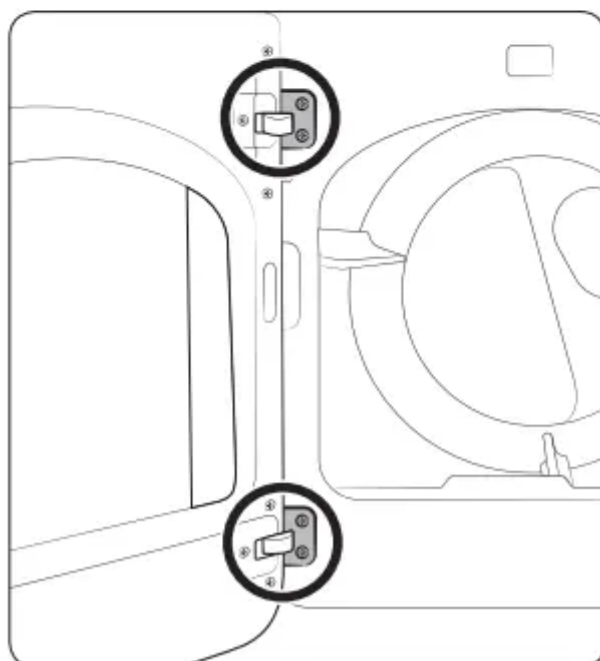
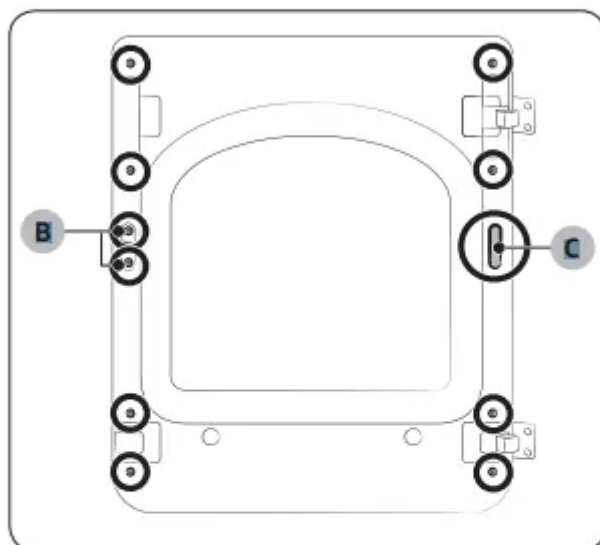
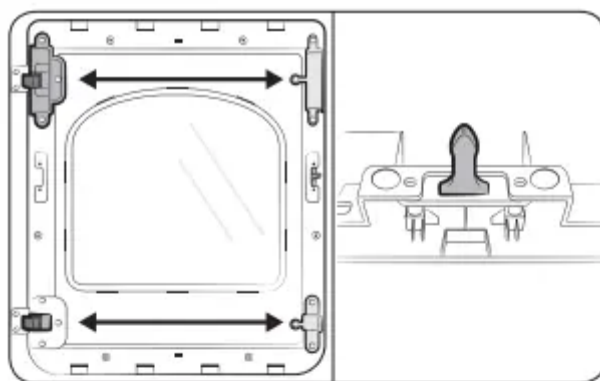

To reverse the direction of the door, we recommend that you contact a qualified technician. It is recommended to put a soft rug on the floor to prevent scratches on the door.

1. Unplug the power cord of the dryer.

2. Remove the four hinge screws from the door, and then remove the door by lifting it up slightly
3. Remove the two screws from the lever holder, and then remove the holder cover.
4. Put the lever holder on the other side as shown, and then tighten the screws. Install the holder cover on the opposite side as shown.
5. Use a flat-head screwdriver to remove the two hinge covers from the original side. Install the hinge covers on the opposite side as shown.
6. Locate and remove the 10 screws as shown. Note that screw B (x2) is longer than the others.
7. Remove the glass holder, and switch the positions of: the hinge cover and the door handle. the hinge holder and the glass-guide holder
8. Remove the door lever, and then move it to the other side as shown.
9. Remove the hole cover (C), and then insert and tighten the glass holder using the removed 10 screws.
10. Install the hole cover on the opposite side as shown.
11. Reinstall the door on the front frame, and then carefully insert and tighten the 4 hinge screws.

## Before you start

Here are a few things you should know before starting your dryer.

### Sort and load

- Put one wash load in the dryer at a time.
- Do not mix heavy and lightweight items together.
- To improve drying efficiency for one or two items, add a dry towel to the load.
- For best results, untangle items before inserting them into the dryer.
- Overloading reduces the tumbling performance, resulting in uneven drying and wrinkling.
- Unless recommended on the care label, do not dry woolens or fiberglass items.
- Avoid drying unwashed items.
- Do not dry items soiled with oil, alcohol, gasoline, etc.

### Functional prerequisite

Lint filter

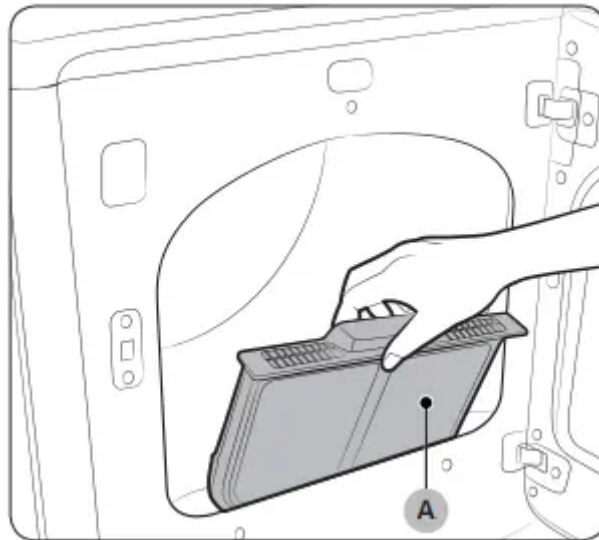

To prevent a risk of fire, make sure to clean the lint filter before or after every load.

1. Turn off the dryer.
2. Open the door, and pull out the lint filter (A) from inside the tumbler.
3. Remove the lint that has accumulated, and then clean the lint filter.
4. Reinsert the lint filter, and then close the door.

#### CAUTION

- Do not operate the dryer without the lint filter in place.
- Do not use a damaged or broken lint filter. This may reduce performance and/or cause fire.

## Operations

**WARNING:** To reduce the risk of fire, electric shock, or injury to persons, read the “Safety information“ before operating this appliance

### Feature panel

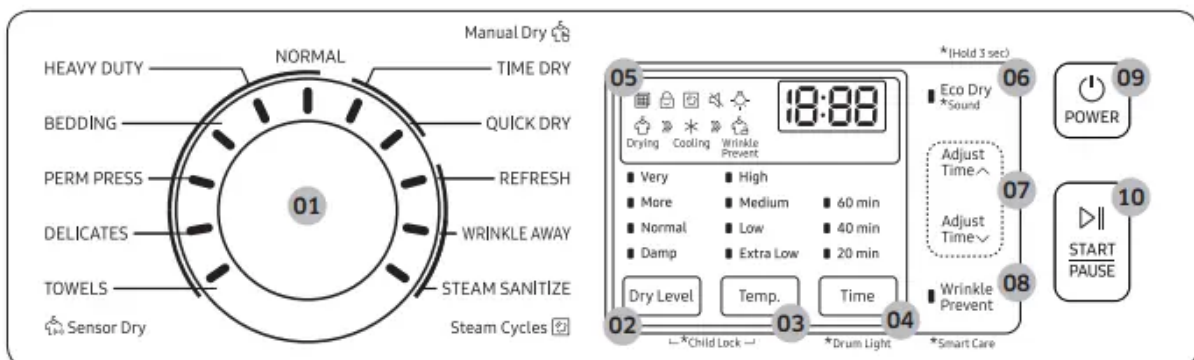

01 Cycle Selector: Turn the cycle selector to select a desired cycle. When a cycle is selected, the cycle indicator lights up.

02 Dry Level: Press to adjust the dryness in the Sensor Dry and Steam Dry cycles. The corresponding indicator turns on.

- Larger or bulkier loads may require Very Dry or More Dry for complete dryness.
- Damp Dry is designed to partially dry items. Use for items that lay flat or hang to dry.  
NOTE This option is not available with STEAM SANITIZE.



03 Temp. Press to change the temperature of the current cycle.

- High: For sturdy cottons or those labeled Tumble Dry.
- Medium: For permanent press, synthetics, lightweight cottons, or items labeled Tumble Dry Medium.
- Low: For heat sensitive items labeled Tumble Dry Low or Tumble Dry Warm.
- Extra Low: Provides the lowest heated drying temperature possible.

04 Time: Press to adjust the drying time for the Manual Dry cycles. This is not available with the Sensor Dry cycles because the dryer determines the drying time by sensing the current moisture level of the load.

05 Digital Graphic Display: Displays all cycle information, including the cycle time, information code, and operating status.

06 Eco Dry: This function is available with NORMAL and TIME DRY. With the Eco Dry activated, drying takes a longer time but the power consumption is reduced. The drying time can be extended by up to 3 times depending on the temperature and load. The Eco Dry function is enabled by default.

07 Adjust Time: You can change the set time in the Manual Dry cycles (TIME DRY, QUICK DRY) and WRINKLE AWAY. To change the cycle time, press  or  until the desired time is displayed.

08 Wrinkle Prevent Wrinkle: Prevent provides approximately 180 minutes of intermittent tumbling in unheated air at the end of the cycle to reduce wrinkling. Press Wrinkle Prevent to activate this feature. The load is dry, and can be removed at any time during the Wrinkle Prevent cycle.

09 POWER: Press to turn on/turn off the dryer.

10 START/PAUSE: Press to start or stop operation

NOTE: Extremely tangled items finished by the washer may degrade the drying efficiency or cause the door to open. We recommend that you untangle the items before drying.

## Simple steps to start

1. Press POWER to turn on the dryer.
2. Turn the Cycle Selector to select a cycle.
3. Change the cycle settings (Dry Level and Time) as necessary.
4. Optionally, you can activate options available by pressing the relevant button (Eco Dry and/or Wrinkle Prevent).
5. Press START/PAUSE. The dryer indicator turns on with an estimated cycle time on the display.

To change the cycle during operation

1. Press START/PAUSE to stop operation.
2. Select a different cycle.
3. Press START/PAUSE again to start the new cycle.

## Cycle overview

**Sensor Dry:** Sensor Dry cycles sense moisture in the load and stop the dryer when the load reaches the dryness level you have selected with Dry Level.

- **NORMAL:** For most fabrics including cottons and linens. If NORMAL is selected, the Eco Dry function is enabled by default. For more information, see Eco Dry in the “Feature panel” section.
- **HEAVY DUTY:** For drying items made out of heavy fabrics, such as jeans, corduroys, or work clothes, with high temperature heat.
- **BEDDING:** For bulky items such as blankets, sheets, and comforters.
- **PERM PRESS:** Dry wrinkle-free cottons, synthetic fabrics, knits, and permanent press fabrics automatically.
- **DELICATES:** For heat-sensitive items at a low drying temperature.
- **TOWELS:** For bath towels and similar items

**Manual Dry:** You can change the drying settings manually to your preference.

- **TIME DRY:** You can specify a cycle time in minutes. If TIME DRY is selected, the Eco Dry function is enabled by default. For more information, see Eco Dry in the “Feature panel” section.
- **QUICK DRY:** A quick drying cycle running for 30 minutes

**Steam Dry:** Use steam to reduce wrinkling and odors on items.

- **REFRESH:** Use to smooth out wrinkles and reduce odors in loads of one to four items. With this cycle selected, a small amount of water is sprayed into the dryer drum after several minutes of tumbling with heat. Confirm that the laundry load is dry.

- **WRINKLE AWAY:** For best results, load 2-3 items at once. You can extend the drying time by a minimum of 20 minutes, depending on the item type or load. Confirm that the laundry load is dry.
- **STEAM SANITIZE:** Use to sanitize items by applying steam and high-temperature heat to the fabric. This cycle can make items soft and reduce smells. Confirm that the laundry load is wet or partially wet.

Cycle guide: The best way to dry items is to follow the instructions on the care label. If no drying instructions are provided, see the following table for reference.

- **Bedspreads & Comforters** Follow the care label instructions or dry using **BEDDING**. Make sure the item is thoroughly dry before using or storing. May require repositioning in the drum to ensure even drying.
- **Blankets:** Use **NORMAL** and dry only one blanket at a time for best tumbling action. Make sure blankets are is thoroughly dry before using or storing.
- **Curtains & Draperies:** Use **PERM PRESS** and the Medium temperature setting to help minimize wrinkling. Dry curtains and draperies in small loads for best results and remove as soon as possible.
- **Cloth Diapers:** Use **NORMAL** and the Medium temperature setting for soft, fluffy diapers.
- **Down-filled Items (jackets, sleeping bags, comforters, etc.):** Use **NORMAL** and the Medium temperature setting. Add a couple of dry towels to absorb moisture and shorten drying time.
- **Foam Rubber (rug backs, stuffed toys, shoulder pads, etc.):** Do not dry on a heat setting. **WARNING** Drying a rubber item with heat may damage it or cause a fire.
- **Pillows:** Use **NORMAL**. Add a couple of dry towels and a pair of clean sneakers to help the tumbling action and to fluff the items. Do not dry kapok or foam pillows using a heated drying cycle.
- **Plastics (shower curtains, outdoor furniture covers, etc.):** Use **TIME DRY** and the Low or Extra Low temperature settings depending on the care label instructions.

**WARNING - Do not dry:**

- Fiberglass items (curtains, draperies, etc.)
- Woolens, unless recommended on the label
- Items spotted or soaked with vegetable or cooking oils

## Special features

### Child Lock

- Child Lock prevents children from playing with the dryer. When Child Lock is activated, all buttons except for the POWER button are disabled. To activate/deactivate Child Lock, simultaneously press and hold Dry Level and Temp. for 3 seconds.
- NOTE: Once Child Lock is activated, it will remain active even after you restart the dryer. If other buttons, except for the POWER button, do not respond, check the Child Lock indicator. If the indicator is on, follow the instructions above to turn Child Lock off.

### Drum Light

To turn on the drum light while the dryer is running, press and hold Time for 3 seconds

NOTE: After 5 minutes of inactivity, the drum light automatically turns off.

### Sound On/Off

- To turn off the dryer's notification beeps and melodies, press and hold Eco Dry for 3 seconds.
- To unmute the dryer, press and hold Dry Level again for 3 seconds.
- NOTE: This function remains active even after you restart the dryer.

Smart Care: If the dryer displays an information code, you can use Smart Care to check the status of the dryer on a smartphone. To use Smart Care, you must have the Samsung Smart Care app installed on your smartphone. NOTE: Smart Care is optimized for Samsung Galaxy and Apple iPhones. (Not compatible with some models). Download the Samsung Smart Care app from the Google Play Store or Apple App store (Search word: "Samsung Smart Washer/Dryer"), and install it on your smartphone. If an information code appears on the dryer, follow these steps:

1. Press and hold Wrinkle Prevent for 3 seconds to activate Smart Care. The Smart Care indicator turns on.
2. Open the Smart Care app on your smartphone.
3. Put the smartphone's camera close to the display of the dryer. The app automatically recognizes the information code, and displays suggestions on your smartphone.
4. If the smartphone fails to recognize the information code more than twice, type the information code manually into the Smart Care app.

### CAUTION

- If light is reflected on the display of the dryer, the smartphone may not recognize the information code.

- If you hold the smartphone at an angle to the dryer's display, the dryer may not recognize the information code. For best results, hold the smartphone so that the front of the panel and the smartphone are parallel or nearly parallel.
- After you use this function, the dryer will delete delete the record of the information code from its code log.

## Maintenance

Keep the dryer clean to prevent decreased performance and to lengthen its life cycle.

**WARNING:** The control board and inlet valve are intentionally not grounded and may present a risk of electric shock only during servicing. Service personnel - Do not contact this part while the dryer is energized.

## Cleaning

### Feature panel

- Clean with a soft, damp cloth. Do not use abrasive substances.
- Do not spray liquid cleaning agents directly on the display of the dryer.
- Some laundry pre-treatment soil and stain removers may damage the feature panel.
- When using liquid cleaning agents, apply them to the cleaning cloth. Do not apply them directly to the dryer. Wipe up any spills or overspray immediately.

### Tumbler

- Remove any stains from the tumbler with an all-purpose cleaner.
- Tumble old towels or rags to remove any remaining stains or cleaning substances. Stains may be still visible, but will not affect subsequent loads.

### Powder coat tumbler

- To clean the powder coat tumbler, use a damp cloth with a mild, non-abrasive cleaner suitable for easily marred surfaces. Remove cleaner residue and dry with a clean cloth.

### Dryer exterior

- Clean with a soft, damp cloth. Do not use abrasive substances.
- Protect the surface from sharp objects.
- Do not place any heavy or sharp objects or a detergent container on the dryer. They can scratch or damage the top cover of the dryer.
- The dryer has a high-gloss finish on the entire surface. Be careful not to scratch or damage the surface.

## Exhaust system

- Check and clean the exhaust system on a yearly or regular basis to maintain optimum performance.
- The external exhaust hood must be cleaned more frequently to ensure a proper air flow.

## Troubleshooting

Checkpoints: If the dryer operates abnormally, first check the list of problems in the table below and try the suggested actions.

### 1. Does not run.

- Make sure the door is latched shut.
- Make sure the power cord is plugged into a live electrical outlet.
- Check your home's circuit breakers or fuses.
- Press or tap START/PAUSE again if the door is opened during a cycle.
- Clean the lint filter

### 2. Does not heat.

- Check your home's circuit breakers or fuses.
- Some cycles do not require heating. Check the selected cycle again.
- For a gas dryer, make sure the gas supply is on.
- Clean the lint filter and exhaust duct.
- The dryer may have moved into the cool-down phase of the cycle.

### 3. Does not dry.

- Check all of the above, plus...
- Make sure the exhaust hood outside your home can open and close freely.
- Check the exhaust system for lint buildup. Ducting should be inspected and cleaned annually.
- Use a 4" rigid metal exhaust duct.
- Do not overload. 1 wash load = 1 dryer load.
- Dry heavy items and light weight items separately.
- Large, bulky items, such as blankets or comforters, may require repositioning to ensure even drying.
- Make sure that your washer is draining properly and extracting adequate water from the load.
- The load may be too small to tumble properly. Add a few towels and restart the dryer.

- The load may be too large to tumble properly. Remove some items and restart the dryer.
- Clean the lint filter.

#### 4. Is noisy.

- Check the load for objects such as coins, loose buttons, nails, etc. Remove promptly.
- It is normal to hear the dryer gas valve or heating element cycle on and off during the drying cycle.
- Make sure the dryer is leveled properly as outlined in the installation instructions.
- It is normal for the dryer to hum due to the high velocity of air moving through the dryer drum, fan, or exhaust system.

#### 5. Dries unevenly.

- Seams, pockets, and other similarly heavy areas may not be completely dry when the rest of the load has reached the selected dryness level. This is normal. You can choose a higher dryness level or a cycle that involves a higher dryness level.
- If one heavy item is dried with a light weight load, such as one towel with sheets, it is possible that the heavy item will not be completely dry when the rest of the load has reached the selected dryness level.
- For the best drying results, dry heavy items and light weight items separately.

#### 6. Has odors.

- Household odors from paint, varnish, strong cleaners, etc. may enter the dryer with the surrounding room air. This is normal as the dryer draws the air from the room, heats it, pulls it through the tumbler, and exhausts it outside.
- When these odors linger in the air, completely ventilate the room before using the dryer.
- Use a cycle featuring the Refresh function. If odors persist, wash and dry the item again.

#### 7. Lint on clothes.

- Make sure the lint filter is cleaned before every load. For clothes that naturally build up lint, clean the filter during the cycle.
- Some fabrics are lint producers (for example, a fuzzy white cotton towel) and they must be dried separately from clothes that are lint trappers (for example, a pair of black linen pants).
- Divide larger loads into smaller loads for drying.
- Check pockets thoroughly before drying, then dry clothes.
- Remove lint inside the drum before drying.

#### 8. Items still wrinkled after WRINKLE PREVENT (WRINKLE-CARE, WRINKLE RELEASE).

- Small loads of 1 to 4 items work best.

- Load fewer items. Load similar-type items.
- Take out the items immediately after drying is complete.

9. Water drips from the nozzle when STEAM CARE starts.

- This is steam condensation. The dripping water will stop after a short time.

10. Sprayed water is not visible during STEAM CARE.

- Sprayed water is difficult to see when the door is closed.

11. Extended time.

- Sensor Dry automatically senses the moisture in the load and shuts the dryer off when the selected dryness level is reached. The drying time can change according to the type and amount of laundry. See the cycle chart for reference

If a problem persists, contact a local Samsung service center.

## Information codes

If the dryer fails to operate, you may see an information code on the display panel. To determine what you should do, check the list of codes in the table below, and then try the suggested actions.

### Code

dC: Operating the dryer with the door open.

- Make sure the door is properly closed.
- Make sure laundry is not caught in the door.

FC: Invalid power source frequency

- Try restarting the cycle.
- If this information code remains, contact a Samsung service center.

AC: Electronic control problem (Invalid Communication).

- Contact a Samsung service center.

HC: High temperature heating check

- Clean the lint filter.
- If this information code remains, contact a Samsung service center.(enter the line test mode)

9C1: The electronic control needs to be checked.

- Check if power is supplied properly.
- If the information code remains, contact a Samsung service center.

tC: The Thermistor1 resistance is very low or high.

- Check for a clogged lint screen
- Check if the vent system is restricted.
- If this information code remains, contact a Samsung service center.

tC5: The Thermistor2 resistance is very low or high.

- Check for a clogged lint screen.
- Check if the vent system is restricted.
- If this information code remains, contact a Samsung service center.





dF: Incorrect door switch.

- Contact a Samsung service center



## Specifications

Fabric care chart: The following symbols provide garment care direction. The clothing care labels include symbols for drying, bleaching, drying and ironing, or dry cleaning when necessary. The use of symbols ensures consistency among garment manufacturers of domestic and imported items. Follow care label directions to optimize garment life and reduce laundering problems.

Wash cycle



	Normal
	Permanent press/Wrinkle resistant/Wrinkle control
	Gentle/Delicates
	Hand wash

Water temperature



	Hot
	Warm
	Cold

NOTE: This represents appropriate wash water temperatures for various items. The temperature range for Hot is 41-52 °C, for Warm 29-41 °C and for Cold 16-29 °C. (Wash water temperature must be a minimum of 16 °C for detergent activation and effective cleaning.)

Bleach

	Any bleach (when needed)
	Only non-chlorine (color-safe) bleach (when needed)
	Tumble dry





Normal

	Permanent press/Wrinkle resistant/Wrinkle control
	Gentle/Delicates

Special instructions

	Line dry/Hang to dry
	Drip dry
	Dry flat







Heat setting

	High
	Medium
	Low
	Any heat
	No heat / Air





Iron dry or steam temperatures

	High
	Medium
	Low

#### Warning symbols for laundering

	Do not wash
	Do not wring
	Do not bleach
	Do not tumble dry
	No steam (added to iron)
	Do not iron

#### Dry-clean

	Dry-clean
	Do not dry-clean
	Line dry / Hang to dry
	Drip dry
	Dry flat

Protecting the environment: This appliance is manufactured from recyclable materials. If you decide to dispose of this appliance, please observe local waste disposal regulations. Cut off the power cord so that the appliance cannot be connected to a power source. Remove the door so that animals and small children cannot get trapped inside the appliance.

#### Specification sheet

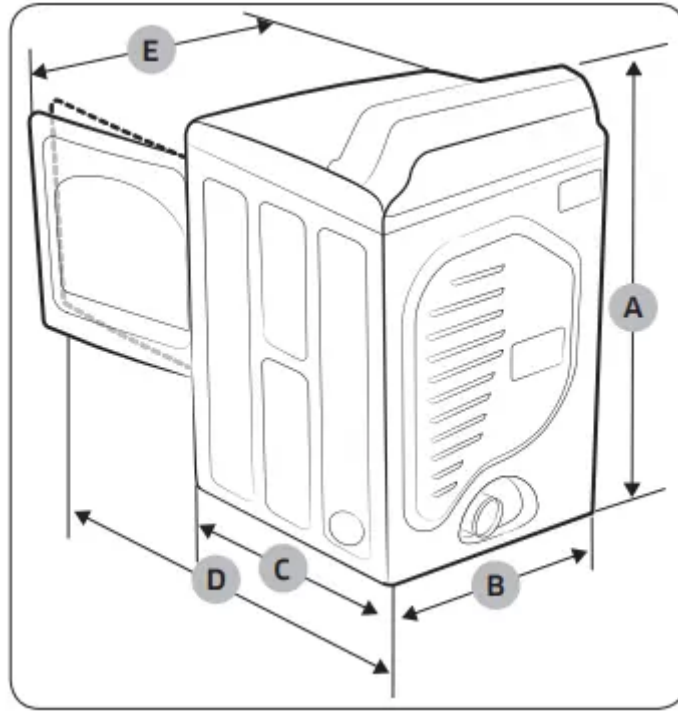















NOTE: "A. Height" Spec can vary from 46 to 46.5 inches (116.8-118.0 cm) depending on the leveling feet adjustment.



Type		Front loading dryer	
Model name		DVE(G)50M7450*	
Dimensions	A. Height	Product - inches (cm)	45.0 (114.4)
		Required for Installation - inches	48.0
	B. Width	Product - inches (cm)	27.0 (68.6)
		Required for Installation - inches	29.0
	C. Depth	Product - inches (cm)	30.0 (76.3)
		Required for Installation - inches	35.0
	D. Depth with door open 90°	Product - inches (cm)	49.80 (126.5)
		Required for Installation - inches	54.82
E. Width with door open 130°	Product - inches (cm)	46.47 (118.0)	
	Required for Installation - inches	51.47	
Water pressure - psi (kPa)		20-116 (137-800)	
NET weight	Electric - lb (kg)	125.7 (57)	
	Gas - lb (kg)		
Heater rating	Electric (W)	5300	
	Gas (BTU/hr)	22000	

Cycle chart

NOTE: For best results, follow the load size recommendations for each dry cycle.

- 
 Large load: Fill the drum to about 3/4 full. Do not add items over this level as they need to tumble freely.
- 
 Medium load : Fill the drum to about 1/2 full.
- 
 Small load : Fill the drum with 3-5 items, not more than 1/4 full.

Cycle		Recommended items	Load size	Dry Level
Sensor Dry	NORMAL	Cottons, work clothes, linens, mixed loads		Normal Dry (Adjustable)
	HEAVY DUTY	Heavy Fabrics such as jeans, corduroys, heavy work clothes		Normal Dry (Adjustable)
	BEDDING	Bulky items such as blankets, sheets, comforters, pillows		Normal Dry (Adjustable)
	PERM PRESS	Shirts, synthetic fabrics, knits, wrinkle-free cottons, permanent press		Normal Dry (Adjustable)
	DELICATES	Underwear, blouses, lingerie		Normal Dry (Adjustable)
	TOWELS	Bath towels and similar items		Normal Dry (Adjustable)
Manual Dry	TIME DRY	Any load		-
	QUICK DRY	Small loads		-
Steam Dry	REFRESH	Shirts, trousers, comforters, pillows		-
	WRINKLE AWAY	Shirts, trouser, blouses		-
	STEAM SANITIZE	Bedding, curtains, children's clothing		Very Dry (No change)

NOTE:  factory setting,  : can be selected



Cycle		Temperature setting				Time setting
		High	Medium	Low	Extra Low	
Sensor Dry	NORMAL		●			
	HEAVY DUTY	●				
	BEDDING	●				
	PERM PRESS		●			
	DELICATES				●	
	TOWELS	●				
Manual Dry	TIME DRY	●	●	●	●	●
	QUICK DRY	●				●
Steam Dry	REFRESH	●				
	WRINKLE AWAY	●				●
	STEAM SANITIZE	●				

Cycle		Options		
		Eco Dry	Adjust Time	Wrinkle Prevent
Sensor Dry	NORMAL	●		●
	HEAVY DUTY			●
	BEDDING			●
	PERM PRESS			●
	DELICATES			●
	TOWELS			●
Manual Dry	TIME DRY	●	●	●
	QUICK DRY		●	●
Steam Dry	REFRESH			●
	WRINKLE AWAY		●	●
	STEAM SANITIZE			●

### Warning

This content is compiled from multiple sources and is provided for reference purposes only. It may not be complete or fully applicable to all situations. If you are unable to resolve your issue, please contact the product manufacturer or an authorized service provider for official support.