

CONTROL PANELS AND FEATURES

WASHER

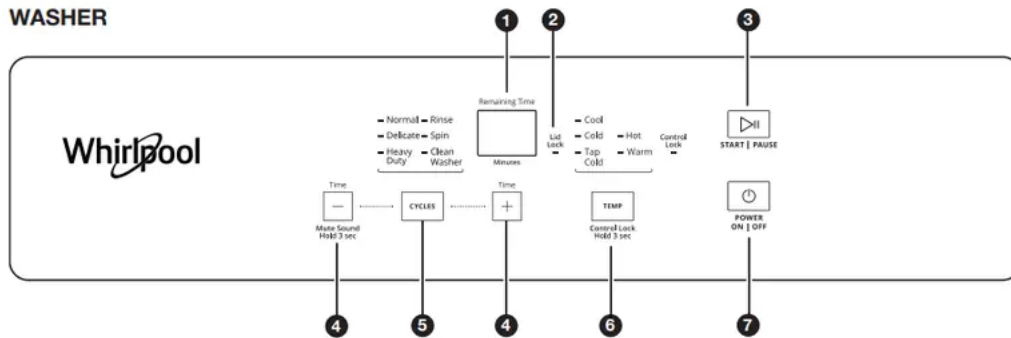

1 LED TIME/STATUS DISPLAY

The Remaining Time display shows the time required for the cycle to complete. Factors such as load size and water pressure may affect the time shown in the display. Tightly packed loads, unbalanced loads, excessive suds, or adding or removing items may cause the washer to adjust the cycle time as well.

2 LID LOCK LIGHT

The Lid Lock indicator lights up when the lid is locked and cannot be opened. If you need to open the lid, press and hold START/PAUSE. The lid will unlock 1 minute after the washer movement has stopped. This may take several minutes if the load was spinning at high speed. Press the START/PAUSE button again to restart the cycle.

3 START/PAUSE

After selecting a wash cycle, press START/PAUSE to start the cycle. Press once to pause a cycle. The flashing lights indicate the selected cycle and the current process.

4 CYCLE TIME (+ or -)

- Press “+” or “-” to adjust the duration of a cycle.
- LED display will show the time remaining for the cycle to complete.
- If an out-of-range adjustment is made, a buzzer will sound.

End-of-Cycle Signal Press and hold the plus (+) button for 3 seconds to enable or disable the end-of-cycle signal.

Press and hold the minus (-) button for 3 seconds to mute the signal.

5 CYCLES

Press CYCLES to select a wash cycle. Choose from Normal, Delicate, Heavy Duty, Rinse, Spin, or Clean Washer.

6 TEMP

Select a wash temperature based on the type of fabric and soils being washed. For best results and following the garment label instructions. use the warmest wash water safe for your fabric.

CONTROL LOCK Press and hold TEMP for 3 seconds to lock the controls.

Press and hold for 3 seconds to unlock. You may still press POWER ON/OFF to turn off the washer.

7 POWER ON/OFF

Press POWER ON/OFF to turn on or off the washer.

Press once while a cycle is running to stop the washer.

DRYER

240V MODELS

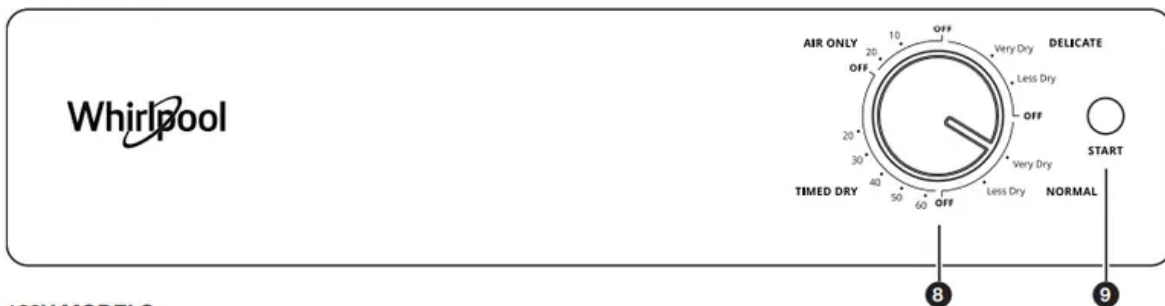

120V MODELS

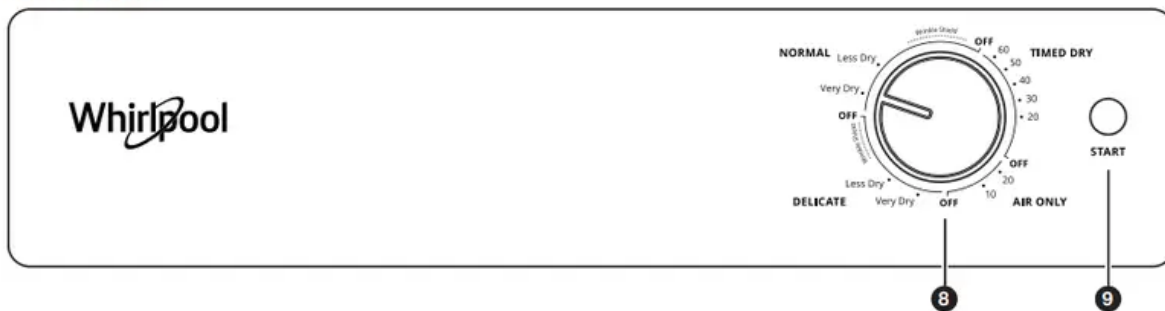

8 DRYER CYCLE KNOB

Use your Dryer Cycle knob to select available cycles on your dryer. Turn the knob to select a cycle for your laundry load.

See “Dryer Cycle Guide” for detailed descriptions of cycles.

TIMED DRY

Will run the dryer for the specified time on the control.

Drying time and temperature will depend on your dryer model.

NORMAL and DELICATE CYCLES

These cycles sense moisture in the load or air temperature and shut off when the load reaches the selected dryness level. They give the best drying in the shortest time. Drying time will vary based on fabric type, load size, and dryness setting.

AIR ONLY

This cycle will run the dryer without heat for the specified time on the control.

9 START BUTTON

Press the START button to start the dryer.

DISPENSERS

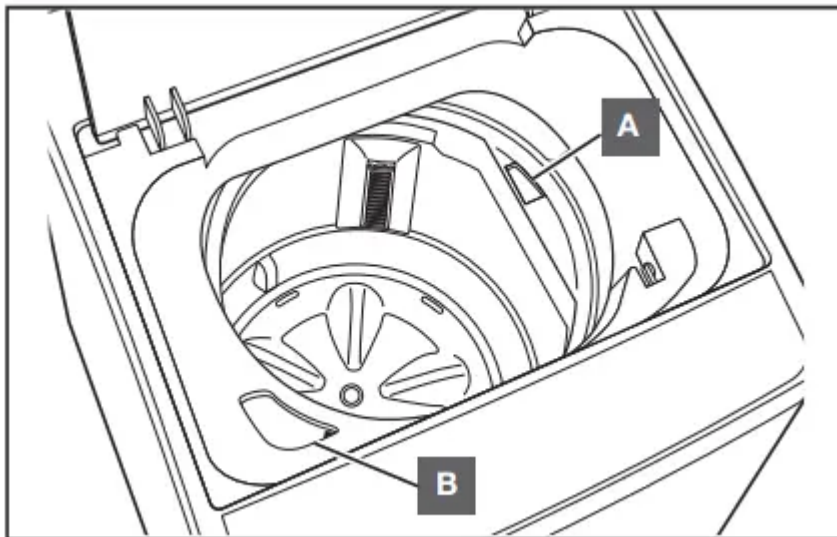

A Liquid fabric softener dispenser

Pour measured liquid fabric softener into the liquid fabric softener dispenser if desired. It will dispense automatically at the optimum time.

- Use only liquid fabric softener in this dispenser.

NOTE: The fabric softener dispenser rotates around the wash basket and may not be in the same spot each time.

B Liquid chlorine bleach dispenser

This dispenser holds up to 3/4 cup (180 mL) liquid chlorine bleach. The bleach will be automatically diluted and dispensed at the optimum time during the wash cycle.

This dispenser cannot dilute powdered bleach.

NOTE: Fill dispenser with only liquid bleach.

WASHER CYCLE GUIDE













Each cycle listing includes a performance chart rating its cleaning power, gentleness on items, and resource efficiency.

Not all cycles or options are available on all models. Refer to the CYCLES button on your washer.

Wash temperatures are selected using the Temp button.

For best performance:

- Choose the cycle that best fits the load being washed.
- Decrease or increase the maximum target water temperature for any cycle.
- Do not leave the washer lid open unattended once the washer has started to fill.

Items to wash:	Cycle:	Load Size:	Wash Time/Spin Speed:	Cycle Details:
Cottons, linens, and mixed-garment loads	Normal		Medium/High	Use this cycle for normally soiled cottons and linens. Wash combines a medium wash time and a high-speed spin to shorten drying time. Good Best Cleaning  Gentleness  Efficiency† 
Machine-wash silks, hand-washed fabrics	Delicate		Short/High	Use this cycle for lingerie and loosely knit items. Wash combines a short wash time for gentle soil removal, and a high-speed spin to shorten drying time. Good Best Cleaning  Gentleness  Efficiency† 
Sturdy fabrics, colorfast items, towels, jeans	Heavy Duty		Long/High	Use this cycle for sturdy or heavily soiled loads, or when using bleach. Wash combines a long wash time, two rinses, and a high-speed spin for maximum soil removal. Good Best Cleaning  Gentleness  Efficiency† 
Swimsuits and items requiring rinsing without detergent	Rinse	N/A	N/A	Use this cycle for additional rinsing of the washer load or hand-washed items. This cycle uses some agitation and finishes with a high-speed spin.
Hand-washed garments or dripping-wet items	Spin	N/A	N/A/High	Use this cycle to remove excess water from the washer load or hand-washed items.
No clothes in washer	Clean Washer	N/A	Short/N/A	Use this cycle every 30 washes to keep the inside of your washer fresh and clean. This cycle uses a higher water level. Use with affresh® washer cleaner tablet or regular liquid chlorine bleach to thoroughly clean the inside of your washer. This cycle should not be interrupted. See "Washer Care." IMPORTANT: Do not place garments or other items in the washer during the Clean Washer cycle. Use this cycle with an empty wash tub. Do not use thickened, easy-pour, or no-splash bleach when running the Clean Washer cycle as excess suds may occur. See "Washer Care" in "Washer/Dryer Maintenance."

†Efficient use of resources, such as energy and water.

IMPORTANT: Do not presoak items in your washer by lifting the lid or stopping the cycle. Failure to follow this instruction can result in property damage. If needed, presoak items in a small wash basin prior to loading the washer.

DRYER CYCLE GUIDE

DRYER CYCLE GUIDE – AUTOMATIC DRY CYCLES

Not all cycles and settings are available on all models.

Both the Normal and Delicate cycles are automatic dry cycles.

They give the best drying in the shortest time. These cycles sense moisture in the load or air temperature and shut off when the load reaches the selected dryness level. Drying time varies based on fabric type, load size, and dryness setting.

Select either the Normal or Delicate cycle based on the fabrics in your load. If you are unsure of the cycle to select for a load, select the Delicate cycle (lower temperature) rather than the Normal cycle (higher temperature).

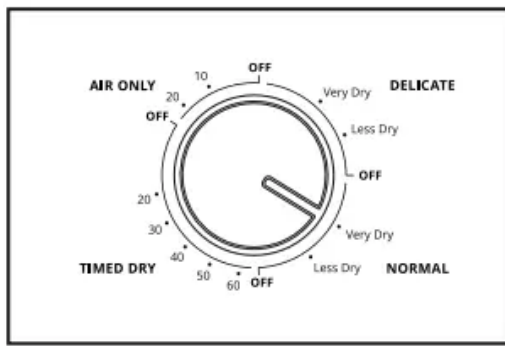

240V Models

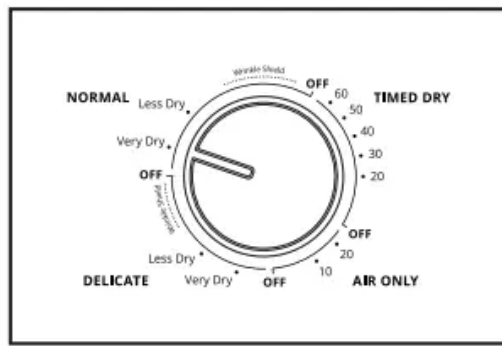

120V Models

WRINKLE SHIELD OPTION (120V models)

This feature will run after your drying cycle is complete. It periodically starts and stops the dryer, tumbling the load without heat to help avoid wrinkling.

Items to dry:	Cycle:	Available Options:	Cycle Details
Corduroys, work clothes	Normal	None	Medium to large loads of mixed fabrics
Lingerie, blouses, washable knit fabrics	Delicate	None	For gently drying delicate items.

NOTE: If loads do not seem as dry as you would like, select Very Dry next time you dry a similar load. If loads seem drier than you like, select Less Dry next time you dry a similar load.

DRYER CYCLE GUIDE – TIMED DRYING

Not all cycles and settings are available on all models.

Timed Dry will allow the dryer to run for the selected time.

Items to dry:	Cycle:	Temperature:	Available Options:	Cycle:
Rubber, plastic, heat-sensitive fabrics	Air Only	No Heat	Time Adjustment	For airing out, re-loosening up laundry.
Heavy, bulky, or lightweight items	Timed Dry	High	Time Adjustment	Completes drying damp.

NOTE: Government energy certifications for this model were based on the Timed Dry cycle with the Maximum drying temperature setting. The as-shipped defaults of Normal cycle, Less Dry, and the Wrinkle Shield option (when applicable) were not used.

USING YOUR WASHER

1. Sort and prepare your laundry



- Empty pockets. Loose change, buttons, or any small object can pass under the agitator and become trapped, causing unexpected sounds.
- Sort items by recommended cycle, water temperature, and colorfastness.
- Separate heavily soiled items from lightly soiled.
- Separate delicate items from sturdy fabrics.
- Do not dry garments if stains remain after washing, because heat can set stains into fabric.

- Treat stains promptly.
- Close zippers, fasten hooks, tie strings and sashes, and remove non-washable trim and ornaments.
- Mend rips and tears to avoid further damage to items during washing.

Helpful Tips:

- When washing waterproof or water-resistant items, load evenly.
- Use mesh garment bags to help avoid tangling when washing delicate or small items.
- Turn knits inside out to avoid pilling. Separate lint-takers from lint-givers. Synthetics, knits, and corduroy fabrics will pick up lint from towels, rugs, and chenille fabrics.

NOTE: Always read and follow fabric care label instructions to avoid damage to your garments.

2. Add laundry products

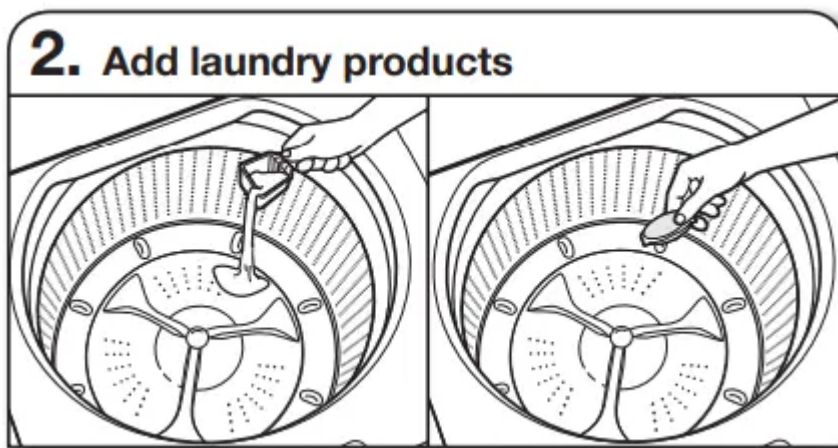

IMPORTANT: Add a measured amount of detergent or single-dose laundry packet into the basket.

If you are using color-safe bleach, Oxi-type boosters, or fabric softener crystals, add to the wash basket prior to adding laundry.

NOTE: Follow the manufacturer's instructions to determine the amount of laundry products to use. Manufacturer suggests using HE detergent.

3. Load laundry into washer

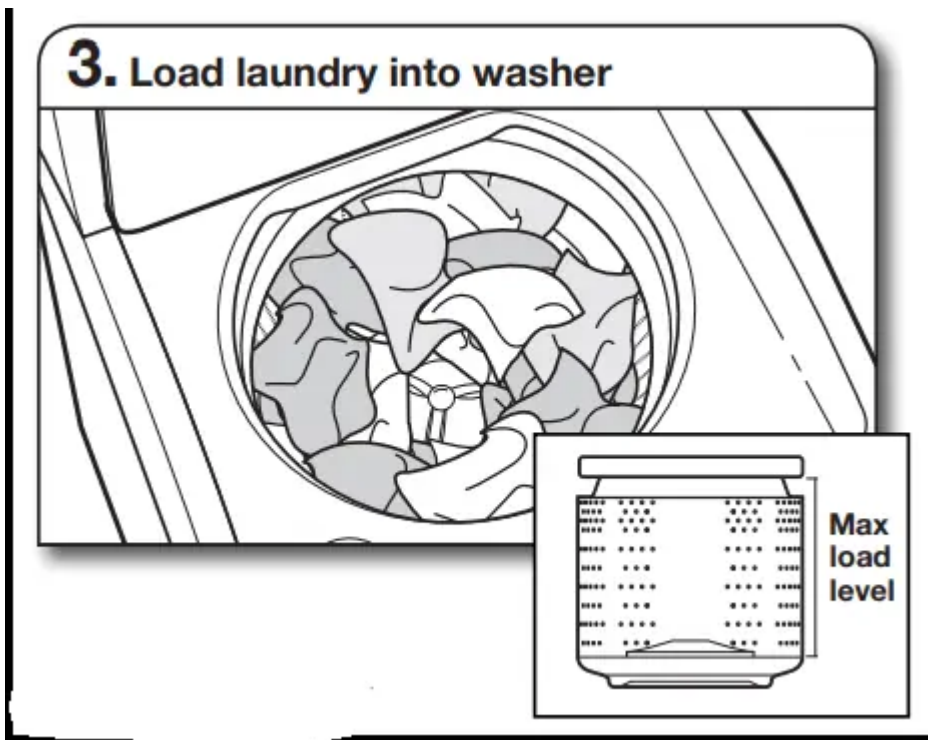

For best performance, load items in loose heaps evenly around the washplate. Try mixing different-sized items to reduce tangling.

IMPORTANT: Items need to move freely for best cleaning and to reduce wrinkling and tangling.

NOTE: The maximum volume is about 1.52 cubic ft. (4.4 lb max. load size per cubic ft.).

4. Add liquid chlorine bleach to dispenser

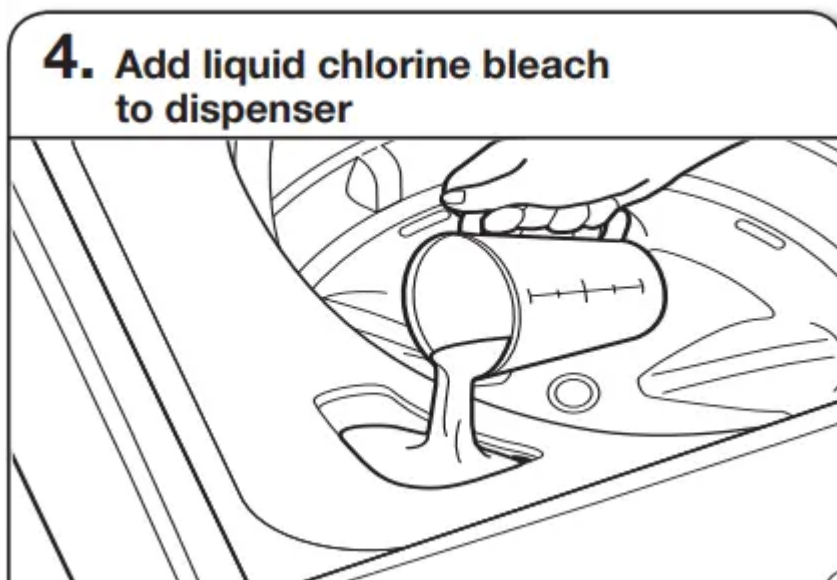

Bleach will be dispensed automatically during the wash part of the cycle. Do not overfill, dilute, or use more than 1 cup (236 mL). Do not use color-safe bleach or Oxi products in the same cycle with liquid chlorine bleach.

5. Add liquid fabric softener

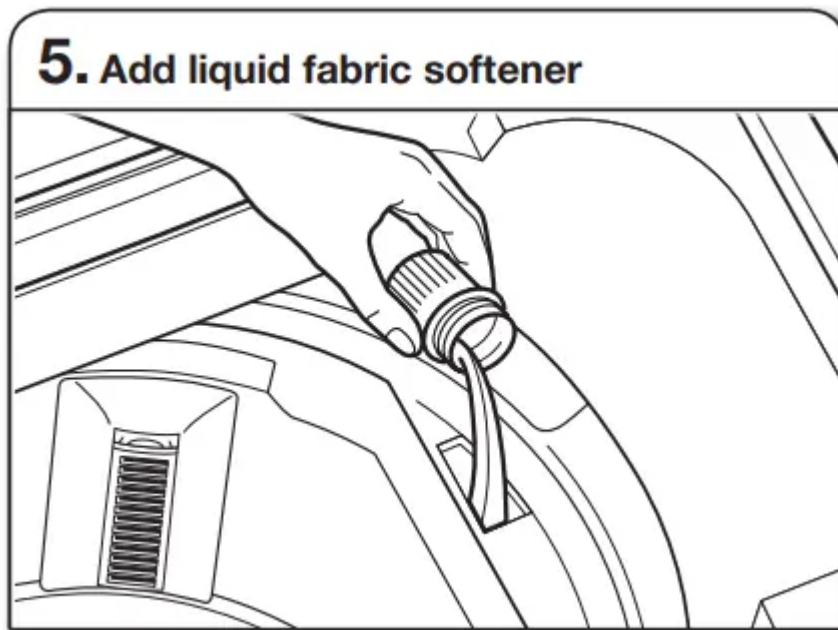

Pour a measured amount of liquid fabric softener into dispenser; always follow manufacturer's directions for correct amount of fabric softener based on your load size. Fabric Softener is added during rinse.

IMPORTANT: Do not overfill or dilute. Overfilling dispenser will cause fabric softener to immediately dispense into washer. It is normal for a small amount of water to remain in the dispenser at the end of a cycle.

NOTE: The fabric softener dispenser rotates around the wash basket and may not be in the same spot each time.

6. Press POWER ON/OFF

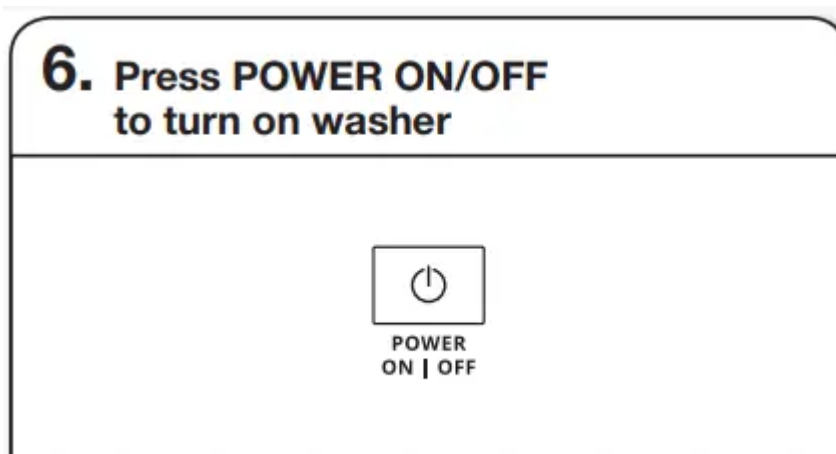

Close the washer lid. Washer will not fill, agitate, or spin with the lid open. Make sure the dispenser drawer is closed completely; then press POWER ON/OFF to turn on the washer.

7. Select wash TEMP

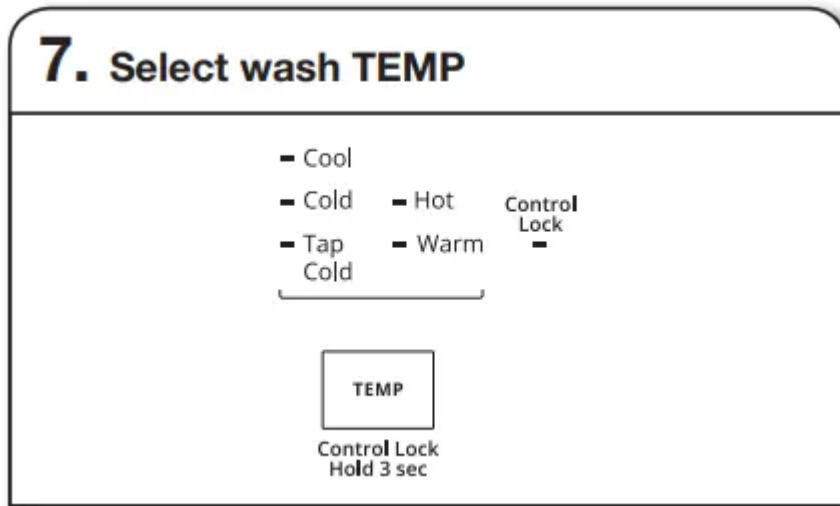

Set the water temperature for the type of fabric and soils being washed. Use the warmest wash water safe for fabric. Follow garment label instructions.

The Rinse and Spin cycles default to a cold rinse; all other cycles default to a warm rinse. Press the TEMP button to choose a different wash temperature.

Selecting Water Temperatures

NOTE: Always read and follow fabric care label instructions to avoid damage to your garments.

Wash Temp	Suggested Fabrics
<p>Hot</p> <p>Some cold water is added to save energy. This will be cooler than your hot water heater setting.</p>	Whites and pastels Durable garments Heavy soils
<p>Warm</p> <p>Some cold water will be added, so this will be cooler than what your previous washer provided.</p>	Bright colors Moderate to light soils
<p>Cool</p> <p>Some warm water may be added to assist in soil removal and to help dissolve detergents.</p>	Colors that bleed or fade Light soils
<p>Cold</p> <p>A small amount of warm water may be added to assist in soil removal and to help dissolve detergents. Water will be colder than “Cool” setting.</p>	Dark colors that bleed or fade Light soils
<p>Tap Cold</p> <p>This is the temperature from your faucet.</p>	Dark colors that bleed or fade Light soils

NOTE: In wash water temperatures colder than 60°F (15.6°C), detergents do not dissolve well. Soils can be difficult to remove. Some fabrics can retain wear wrinkles and have increased pilling (the formation of small lint-like balls on the surface of garments).

8. Select CYCLES

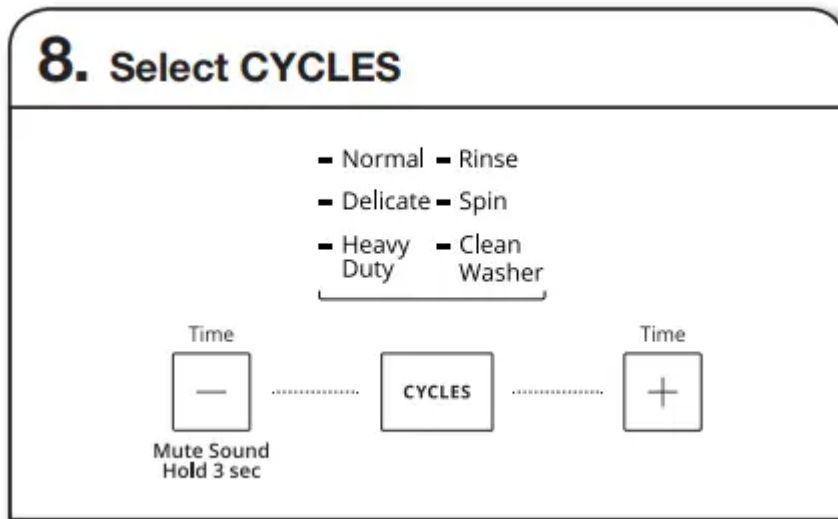

Press the CYCLES button to select your wash cycle. See “Cycle Guide” for details on cycle features.

9. Press START/PAUSE to begin wash cycle



Press the START/PAUSE button to start the wash cycle.

When the cycle has finished, the end-of-cycle signal will sound (if set). Wait 1 minute for the lid to unlock. Promptly remove items when cycle is done to avoid odor, reduce wrinkling, and reduce rusting of metal hooks, zippers, and snaps.

Unlocking the lid to add items

If you need to open the lid to add one or two missed items:

Press the START/PAUSE button to pause the washer; the lid will unlock once the washer movement has stopped. This may take several minutes if the load was spinning at a high speed. Then close the lid and press the START/PAUSE button again to restart the cycle.



To stop or restart your washer:

- To stop the washer at any time, press the START/ PAUSE button and the cycle will pause.
- To restart the washer, press the START/PAUSE button and the cycle will resume.

NOTE: If the washer is paused while in the spin phase, the lid will unlock after 1 minute. During that minute, the Start/Pause button will be disabled.

USING YOUR DRYER

WARNING: To reduce the risk of fire, electric shock, or injury to persons, read the Important Safety Instructions before operating this dryer.

Before using your dryer, wipe the dryer drum with a damp cloth to remove dust from storing and shipping.

1. Clean the lint screen

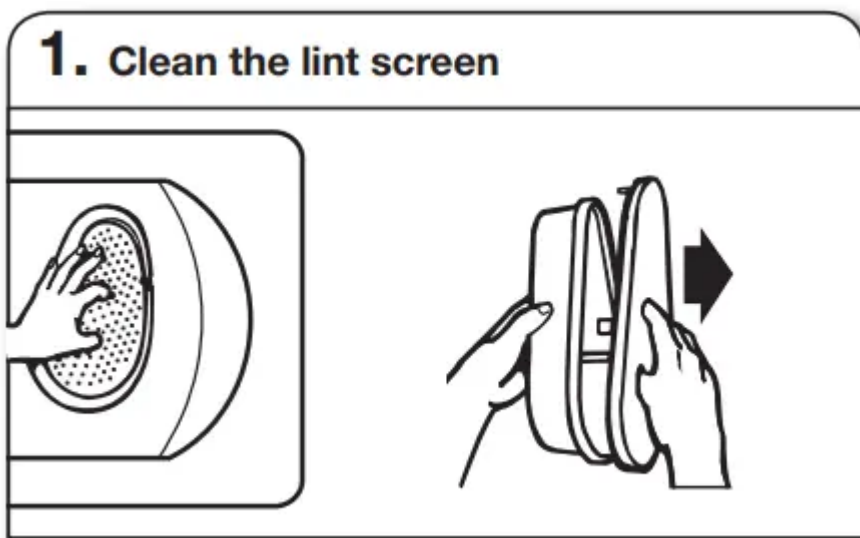

Clean the lint screen before each load.

Reach inside the drum and pull out the lint screen and its cover.

Separate the cover and the screen by squeezing the screen and pulling on the cover at the same time. Roll lint off the screen with your fingers. Put the lint screen and its cover back together and push firmly into place.

Do not rinse or wash screen to remove lint. For additional cleaning information, see "Cleaning the lint screen."

2. Load the dryer

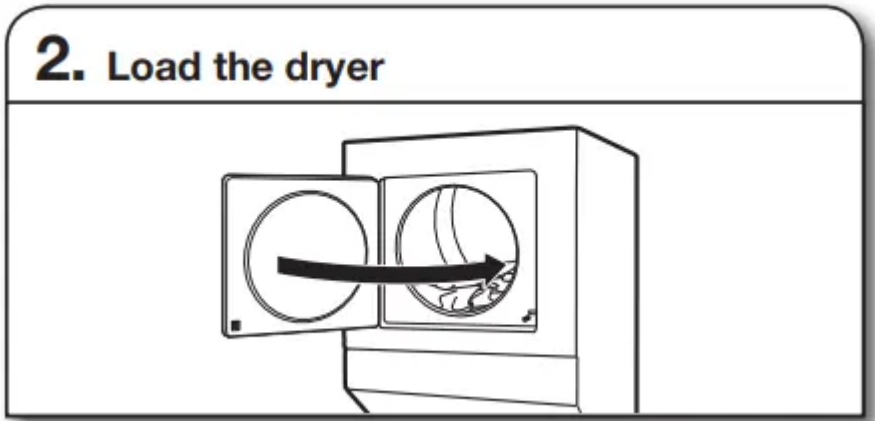

Place laundry in the dryer. Close the door.

Do not tightly pack the dryer; clothes should be able to tumble freely.

3. Select cycle

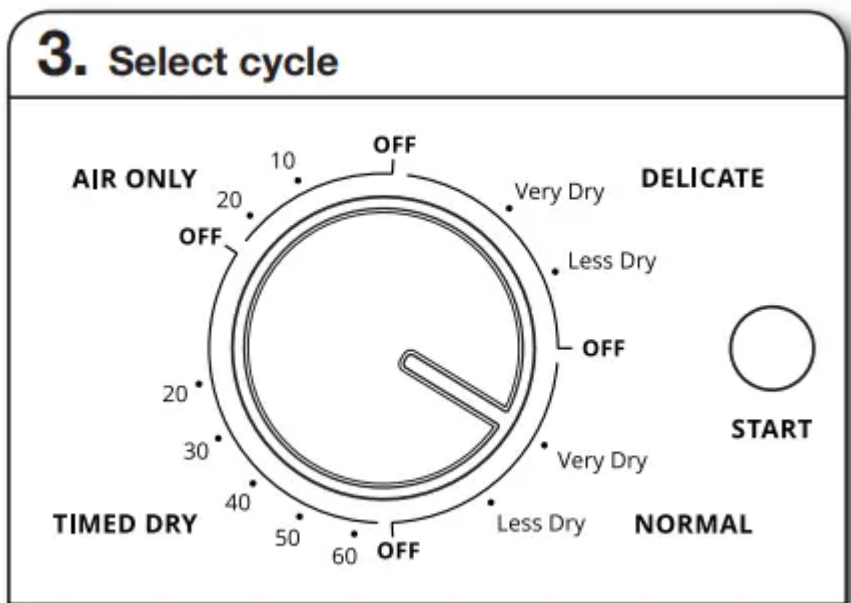

Select the desired cycle for your load. See “Dryer Cycle Guide” for more information about each cycle.

Normal and Delicate Cycles You can select a different dryness level, depending on your load, by turning the knob to the desired dryness level.

Selecting Very Dry or Less Dry automatically adjusts the dryness level at which the dryer will shut off. Once a dryness level is set, it cannot be changed without stopping the cycle.

These automatic dry cycles give the best drying in the shortest time. Drying time varies based on fabric type, load size, and dryness setting.

NOTE: Very Dry removes more load moisture. Less Dry removes less moisture and is used for loads you may want to put on a hanger to complete drying.

4. Press START button to begin cycle

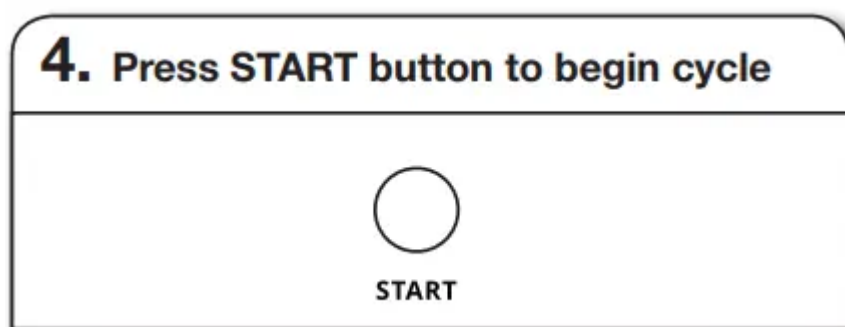

Push and hold the START button to begin the cycle.

Promptly remove garments after cycle has completed to reduce wrinkling.

WASHER CARE

Recommendations to Help Keep Your Washer Clean and Performing at Its Best

1. Always use High Efficiency Detergents and follow the
2. Use warm and hot wash water settings sometimes (not
3. Always leave the washer lid open between uses to help

Cleaning Your Top-Loading Washer

Read these instructions completely before beginning the routine cleaning processes recommended below. This Washer Maintenance Procedure should be performed, at a minimum, once per month or every 30 wash cycles, whichever occurs sooner, to control the rate at which soils and detergent may otherwise accumulate in your washer.

Cleaning the Inside of the Washer

To keep your washer odor-free, follow the usage instructions provided above and use this recommended monthly cleaning procedure:

Recommended Cycle for Cleaning the Washer

Refer to the "Cycle Guide" for the optimal cycle for cleaning the inside of the washer. Use this cycle with affresh Washer Cleaner or liquid chlorine bleach as described below.

Begin procedure

Washer Cleaner Cycle Procedure (Recommended for Best Performance):

- a. Open the washer lid and remove any clothing or items.
- b. Use an affresh® Machine Cleaning Wipe or a soft, damp cloth or sponge to clean the inside of the door.
- c. Place an affresh® Washer Cleaner tablet in the bottom of the washer basket.

- d. Do not add any detergent or other chemical to the washer when following this procedure.
- e. Close the washer lid.
- f. Select the Clean Washer cycle.
- g. Press and hold START/PAUSE to begin the cycle.

NOTE: For best results, do not interrupt cycle. If cycle must be interrupted, press POWER ON/OFF. After the Clean Washer cycle has stopped, run a Rinse cycle to rinse cleaner from washer.

Chlorine Bleach Procedure (Alternative):

- a. Open the washer lid and remove any clothing or items.
- b. Add 1 cup (236 mL) of liquid chlorine bleach to the bleach compartment.

NOTE: Use of more liquid chlorine bleach than is recommended above could cause washer damage over time.

- c. Close the washer lid.
- d. Do not add any detergent or other chemical to the washer when following this procedure.
- e. Select the Clean Washer cycle.
- f. Press and hold START/PAUSE to begin the cycle.

The Clean Washer Cycle Operation is described below.

NOTE: For best results, do not interrupt cycle. If cycle must be interrupted, press POWER ON/OFF. After the Clean Washer cycle has stopped, run a Rinse cycle to rinse cleaner from washer.

Description of Clean Washer Cycle Operation:

During this cycle, there will be some agitation and spinning to increase the removal of soils.

After the cycle is complete, leave the lid open to allow for better ventilation and drying of the washer interior.

Cleaning the Dispensers

After a period of using your washer, you may find some residue buildup in the washer's dispensers. To remove residue from the dispensers, wipe them with a damp cloth and towel dry. Do not attempt to remove the dispensers or trim for cleaning. The dispensers and trim are not removable. Use an all-purpose surface cleaner, if needed.

Cleaning the Outside of the Washer

Use an affresh® Machine Cleaning Wipe or a soft, damp cloth or sponge to wipe away any spills. Use only an affresh® Machine Cleaning Wipe or mild soaps or cleaners when cleaning external washer surfaces.

IMPORTANT: To avoid damaging the washer's finish, do not use abrasive products.

Cleaning The Lint Filter

Clean filter after every load.

1. Press down, then out, to remove the lint filter.



2. Open the lint filter, remove lint, and clean with water.

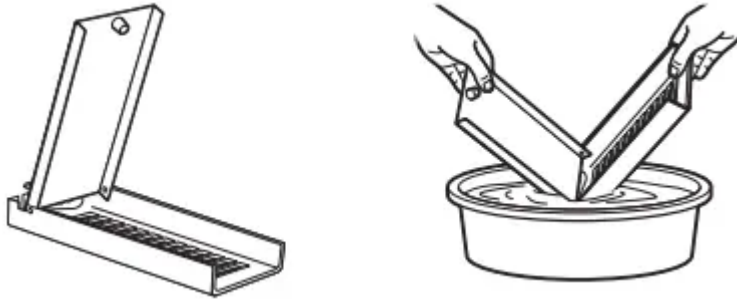

3. Insert the lint filter bottom first; then press down and in to replace the filter.



CLEANING THE WASHER/DRYER LOCATION

Keep washer/dryer area clear and free from items that would block the airflow for proper washer/dryer operation. This includes clearing piles of laundry in front of the washer/dryer.

CLEANING THE DRYER INTERIOR

To clean dryer drum:

1. Apply a liquid, nonflammable household cleaner to the
2. Wipe drum thoroughly with a damp cloth.
3. Tumble a load of clean cloths or towels to dry the drum.

NOTE: Garments that contain loose dyes, such as denim blue jeans or brightly colored cotton items, may discolor the dryer interior. These stains are not harmful to your dryer and will not stain future loads of clothes. Dry these items inside out to avoid drum staining.

REMOVING ACCUMULATED LINT

From Inside the Dryer Cabinet

Lint should be removed every 2 years, or more often, depending on dryer usage. Cleaning should be done by a qualified servicer.

From the Exhaust Vent

Lint should be removed every 2 years, or more often, depending on dryer usage.

CLEANING THE LINT SCREEN

Every load cleaning

A screen blocked by lint can increase drying time.

The lint screen is located inside the dryer on the back wall.

To clean:

1. Pull out the lint screen and its cover. Separate the cover

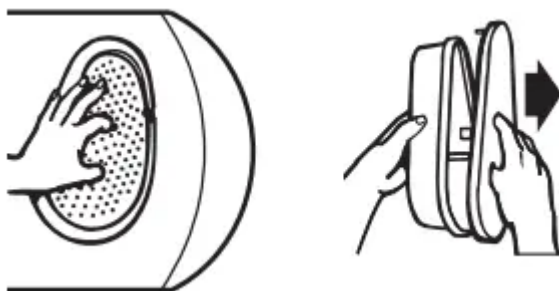

Do not rinse or wash the screen to remove lint. Wet lint is hard to remove.

2. Put the lint screen and its cover back together and push

IMPORTANT:

- Do not run the dryer with the lint screen loose, damaged, blocked, or missing. Doing so can cause overheating and damage to both the dryer and fabrics.
- If lint falls off the screen into the dryer during removal, check the exhaust hood and remove the lint. See “Venting Requirements” in the Installation Instructions.

As needed cleaning

Laundry detergent and fabric softener residue can build up on the lint screen. This buildup can cause longer drying times for your clothes, or cause the dryer to stop before your load is completely dry. The screen is probably clogged if lint falls off while the screen is in the dryer.

Clean the lint screen with a nylon brush every 6 months. or more frequently. if it becomes clogged due to a residue buildup.

To wash:

1. Roll lint off the screen with your fingers.
2. Wet both sides of lint screen with hot water.
3. Wet a nylon brush with hot water and liquid detergent.
Scrub lint screen with the brush to remove residue buildup.



4. Rinse screen with hot water.
5. Thoroughly dry lint screen with a clean towel. Reinstall screen in dryer.

CHANGING THE DRUM LIGHT (on some models)

1. Unplug dryer or disconnect power.
2. Open the dryer door. Locate the light bulb cover on the back wall of the dryer. Using a Phillips-head screwdriver, remove the screw located in the lower right-hand corner of the cover. Remove the cover.



3. Turn bulb counterclockwise. Replace the bulb with a 10-watt appliance bulb only.
Replace the cover and secure with the screw.
4. Plug into a grounded outlet or reconnect power.

VACATION, STORAGE, AND MOVING CARE

Non-Use or Storage Care

Operate your washer/dryer only when you are at home.



If you will be on vacation or not using your washer/dryer for an extended period of time, you should:

1. Unplug washer/dryer or disconnect power.
2. Turn off water supply to washer, to avoid flooding due to water pressure surge.
3. For gas dryers only: Close shut-off valve to gas supply line.
4. Clean lint screen. See “Cleaning the Lint Screen”.

Moving Care

For power supply cord-connected washer/dryers:

1. Unplug the power supply cord.
2. Make sure leveling legs are secure in washer/dryer base.
3. Continue with “For washers/dryers” on next page

For washers/dryers:

1. Shut off both water faucets. Disconnect and drain water inlet hoses.
2. If washer/dryer will be moved during freezing weather, follow “Winter Storage Care” directions before moving.
3. Disconnect drain hose from drain system and drain any remaining water into a pan or bucket. Disconnect drain hose from back of washer.
4. Place inlet hoses and drain hose inside washer basket.
5. Drape power cord over edge and into washer basket.
6. Place packing tray from original shipping materials back inside washer/dryer. If you do not have packing tray, place heavy blankets or towels into basket opening. Close lids/doors and place tape over lids/doors and down front of washer/dryer. Keep lids/doors taped until washer/dryer is placed in new location.

WINTER STORAGE CARE

IMPORTANT: To avoid damage, install and store washer/dryer where it will not freeze. Because some water may stay in hoses, freezing can damage washer/dryer. If storing or moving during freezing weather, winterize your washer/dryer.

To winterize washer/dryer:

1. Shut off both water faucets, disconnect and drain water inlet hoses.
2. Put 1 qt. (1 L) of R.V.-type antifreeze in basket and run washer on Normal cycle for about 2 minutes to mix antifreeze and remaining water.
3. Unplug washer/dryer or disconnect power.

REINSTALLING/USING WASHER/DRYER AGAIN

To reinstall washer/dryer after non-use, vacation, moving, or winter storage:

1. Refer to Installation Instructions to locate, level, and connect washer/dryer.
2. Before using again, run washer/dryer through the following recommended procedure:

To use washer/dryer again:

1. Flush water pipes and hoses. Reconnect water inlet hoses. Turn on both water faucets.

TROUBLESHOOTING – WASHER

If you experience	Possible Causes	Solution
Vibration or Off-Balance		
Vibration, rocking, or “walking”	Feet may not be in contact with the floor and locked.	Front and rear feet or casters must be in firm contact with the floor, and washer/dryer must be level to operate properly.
	Washer may not be level.	<p>Check floor for flexing or sagging. If flooring is uneven, place a 3/4" (19 mm) piece of plywood under your feet to level the washer/dryer and reduce sound.</p> <p>See “Level the Washer/Dryer” in the Installation Instructions.</p>
	Load could be unbalanced.	Load items in loose heaps evenly around the basket. Adding wet items to washer or adding more items to a full basket could unbalance washer.
Avoid washing single items. Balance a single item, such as a rug or jeans jacket with a few extra items. Redistribute the load, close the lid, and press PAUSE.		
Item or load not suitable for selected cycle. See “Washer Cycle Guide” and “Using Your Washer.”		
Noises		
Clicking or metallic noises	Objects may be caught in washer drain system.	Empty pockets before washing. Loose items, such as coins could fall between basket and tub or pump. It may be necessary to call for service to inspect items.
		It is normal to hear metal items on clothing, such as snaps, buckles, or zippers touch against the steel basket.

Gurgling or humming	Washer may be draining water.	It is normal to hear the pump making a continuous humming sound with periodic gurgling or splashing as large amounts of water are removed during the drain cycles.
Humming	Load sensing may be occurring.	You may hear the hum of the sensing spinning as the drum has started the washer. This is normal.
Whirring	Basket may be slowing down.	You may hear the whirring sound of the basket slowing down. This is normal.
Water Leaks		
Check the following for proper installation:	Washer not level.	Water may splash off basket if washer is not level.
	Fill hoses not attached tightly.	Tighten fill-hose connection.
	Fill hose washers	Make sure fill hose flat washers are properly installed.
	Drain hose connection	Properly secure drain hose to drainpipe or standpipe.
		Do not place tape over drain opening.
	Check household plumbing for leaks or clogged sink or drain.	Water can back up out of a clogged sink or drain. Check all household plumbing for leaks (laundry room, kitchen, and bathroom drain pipe, water pipes, and faucets.)
Washer not loaded as recommended.	An unbalanced load can cause basket to be out of alignment and cause water to splash off tub. See "How to Load Your Washer" for loading instructions.	
Washer not performing as expected		
Not enough water in washer	Load not completely covered in water.	This is normal operation for an HE low-water fill washer. A full load will not be completely underwater. The washer senses load sizes and adds correct amount of water.



		<p>optimal cleaning. IMPORTANT: Do not add water to the washer. Adding water lifts the items off the bottom of the tub, resulting in less effective cleaning.</p> <p>Run Clean Washer cycle to optimize the wash performance.</p>
Washer won't run or fill; washer stops working	Check for proper water supply.	Hose(s) must be attached and have water valve.
		Water faucet(s) must be turned on.
		Check that inlet valve screens have not been clogged.
		Check for any kinks in inlet hoses, which could restrict water flow.
	Check proper electrical supply.	Plug power cord into a grounded 3 prong outlet.
		Do not use an extension cord.
		Ensure there is power to outlet.
		Reset a tripped circuit breaker. Replace any blown fuses. NOTE: If problems continue, contact an electrician.
	Normal washer operation.	Lid must be closed for washer to run.
		Washer will pause during certain phases of cycle to allow water to drain and interrupt cycle.
Washer may be stopped to reduce suds.		
Washer may be tightly packed.	Remove several items, rearrange load evenly on washplate. Close lid, press START/PAUSE.	



		<p>Add only one or two additional items after started.</p> <p>Do not add more water to the washer.</p>
	<p>Not using HE detergent or using too much HE detergent.</p>	<p>Only use HE detergent. Suds from regular slow or stop the washer. Always measure and follow detergent directions based on your requirements.</p> <p>To remove suds, cancel cycle. Select Rinse and not add more detergent.</p>
<p>Washer not draining/spinning; loads are still wet</p>	<p>Small items may have been caught in pump or between basket and tub, which can slow draining.</p>	<p>Empty pockets and use garment bags for small items.</p>
	<p>Using cycles with a lower spin speed.</p>	<p>Cycles with lower spin speeds remove less water than cycles with high spin speeds. Use the recommended cycle/speed spin for your item.</p>
	<p>Washer may be tightly packed or unbalanced.</p>	<p>Tightly packed loads may not allow the washer to spin correctly, leaving the load wetter than normal. Rearrange the wet load for balanced spinning to remove excess water.</p> <p>See "Using Your Washer" for loading recommendations.</p>
	<p>Load unbalanced.</p>	<p>See "Vibration or Off-Balance" in "Troubleshooting" section for more information.</p>
	<p>Check plumbing for correct drain hose installation. Drain hose extends into standpipe farther than 4.5" (114 mm).</p>	<p>Check drain hose for proper installation. Unhook and reform and securely attach to drainpipe or tub. Do not force over drain opening. Lower drain hose if the standpipe is more than 96" (2.4 m) above the floor. Remove excess water from drain hose.</p>



	Not using HE detergent or using too much HE detergent.	Suds from regular detergent or using too much HE detergent can slow or stop draining or spinning. Use only HE detergent. Always measure and follow detergent directions for your load. To remove extra suds, select RINSE. Do not add detergent.
Incorrect or wrong wash or rinse temperatures	Check for proper water supply.	Make sure that hot and cold inlet hoses are attached to the washer.
		Both hoses must be attached to both wash and rinse inlets and have both hot and cold water flowing through them.
		Check that inlet valve screens are not clogged.
		Remove any kinks in hoses.
Load not rinsed	Check for proper water supply.	Make sure hot and cold inlet hoses are not crossed.
		Hoses must be attached and have water flowing through them to the inlet valves or faucet.
		Both hot and cold water faucets must be open.
		Inlet valve screens on washer may be clogged.
	Remove any kinks in the inlet hose.	
	Not using HE detergent or using too much HE detergent.	The suds from regular detergent can cause the washer to operate incorrectly.
		Use only HE detergent. Be sure to measure detergent.
		Always measure detergent and follow detergent directions based on load size and soil level.



	Washer may be tightly packed.	<p>The washer is less efficient at rinsing when packed.</p> <p>Load items in loose heaps evenly around the tub.</p> <p>Use cycle designed for the fabrics being washed.</p> <p>Add only one or two additional items after cycle started.</p>
Sand, pet hair, lint, etc. on load after washing	Heavy sand, pet hair, lint, and detergent or bleach residues may require additional rinsing.	Run an additional Rinse cycle.
Load is tangling	Washer not loaded as recommended.	<p>Load items in loose heaps evenly around the tub.</p> <p>Reduce tangling by mixing types of load items. Use recommended cycle for the type of items being washed.</p>
	Wash action and/or spin speed too fast for load.	Select a cycle with a slower wash action and a lower spin speed. Note that items will be wetter than normal after a higher speed spin.
Not cleaning or removing stains	Wash load not completely covered in water.	Washer senses load size and adds correct amount of water. This is normal and necessary for clothes to be cleaned.
	Added more water to washer.	Do not add more water to washer. Adding more items off the washplate, resulting in less effective cleaning.
	Washer not loaded as recommended.	<p>Load items in loose heaps evenly around the tub.</p> <p>Add only one or two additional items after cycle started.</p>



	Not using HE detergent or using too much HE detergent.	The suds from regular detergent can keep operating correctly.
		Use only HE detergent. Be sure to measure.
		Always measure detergent and follow directions based on load size and soil level.
	Not using correct cycle for fabric type.	Use a higher soil level cycle option and wash at higher temperature to improve cleaning.
		Use Heavy Duty cycle for tough cleaning.
		See the “Cycle Guide” to match your load to the correct cycle.
	Not using dispensers.	Use dispensers to avoid chlorine bleach and softener staining.
		Load dispensers before starting a cycle.
		Avoid overfilling.
		Do not add products directly onto load.
	Not washing like colors together.	Wash like colors together and remove promptly after cycle is complete to avoid dye transfer.
	Odors	Monthly maintenance not done as recommended.
		Unload washer as soon as cycle is complete.
Not using HE detergent or using too much HE detergent.		Use only HE detergent. Be sure to measure.



		Always follow the detergent directions.
		See “Washer Care” section.
Fabric damage	Sharp items were in pockets during wash cycle.	Empty pockets, zip zippers, and snap or h before washing to avoid snags and tears.
	Strings and straps could have tangled.	Tie all strings and straps before starting w
	Items may have been damaged before washing.	Mend rips and broken threads in seams be
	Fabric damage can occur if the load is tightly packed.	Load items in loose heaps evenly around v
		Load items should move freely during was damage.
		Use cycle designed for the fabrics being w
		Add only one or two additional items after started.
	Garment care instructions may not have been followed.	Always read and follow garment manufact instructions. See the “Cycle Guide” to mat with the best cycle.
	Liquid chlorine bleach may have been added incorrectly.	Do not pour liquid chlorine bleach directly up bleach spills.
		Undiluted bleach will damage fabrics. Do n than recommended by manufacturer.
Do not place load items on top of bleach d loading and unloading washer.		



Incorrect dispenser operation	Clogged dispensers or laundry products dispensing too soon.	Do not overfill dispenser. Overfilling causes overflowing.
		Load dispensers before starting a cycle.
		It is normal for small amounts of water to be dispensed from the dispenser at the end of the cycle.
	Fabric softener thickens as it gets older. If there is an increase of fabric softener in the dispenser during a cycle, check the age of the fabric softener and if needed, replace it.	
	Liquid chlorine bleach or fabric softener not used in dispensers.	Use only liquid chlorine bleach in the bleach dispenser. Use only fabric softener in the fabric softener dispenser.
Powdered detergent not dissolving completely in load	Using too much HE detergent.	Follow the manufacturer's instructions to determine the correct amount of detergent to use.
	Water temperature is very cold.	Select a warmer wash temperature.
Single-dose laundry packet not dissolving	Adding laundry packet incorrectly.	Be sure laundry packet is added to washer before adding clothes. Follow the manufacturer's instructions to avoid damage to your items.
Error Code Appears in Display		
E1 - Water inlet alarm	Water level not reached after 20 minutes.	Check that the water faucets are not closed.
		Check that the water pressure in the house is at least 20 kPa.
		Clean the inlet hose filter screens.



		Check that the drain hose is not below 27.5 cm (11 in) from the floor.
E2 - Draining alarm	Washer is still detecting water after draining for 8 minutes.	Check that the drain hose is not more than 27.5 cm (11 in) from the floor.
		Remove any clogs from the drain hose.
E3 - Unbalanced alarm	Washer may be tightly packed or clothes are not evenly distributed.	Remove several items, rearrange load evenly on washplate, and restart the Spin cycle.
E4 - Open lid alarm	Opening the lid during the Spin cycle.	Close the lid.
E5, EA, EC, EL, or EP -Other errors	Other	Call for technical assistance - see "Assistance" on the back cover.

TROUBLESHOOTING – DRYER



If you experience	Possible Causes	Solution
Dryer not performing as expected		
Clothes are not drying satisfactorily, drying times are too long	Lint screen clogged with lint.	Lint screen should be cleaned before each load.
	The Air Only cycle has been selected.	Select the correct cycle for the types of garments. See "Dryer Cycle Guide."
	Load too large and heavy to dry quickly.	Separate the load to tumble freely.
	Exhaust vent or outside exhaust hood clogged with lint, restricting air movement.	Run the dryer for 5-10 minutes. Hold your hand to the outside exhaust hood to check air movement. If you feel no air movement, clean exhaust system of lint. Use a vacuum or brush to clean vent with heavy metal or flexible metal vent pipe. Vent pipe should not be crushed or kinked. See Installation Instructions.
	Fabric softener sheets blocking the grille.	Use only one fabric softener sheet, and use it correctly.
	Exhaust vent not the correct length.	Check that the exhaust vent is not too long or too short. Long venting will increase drying time. Vent pipe should not be crushed or kinked. See Installation Instructions.
	Exhaust vent diameter not the correct size.	Use 4" (102 mm) diameter vent material.
	Dryer located in a room with temperature below 45°F (7°C).	Proper operation of dryer cycles requires a room temperature of 45°F (7°C).
	Dryer located in a closet without adequate opening.	Closet doors must have ventilation opening at the bottom of the door. The front of the dryer requires a minimum of 1" (25 mm) of airspace, and, for most models, the top of the dryer requires 5" (127 mm). See Installation Instructions.



Dryer will not run	Door not closed completely.	Make sure the dryer door is closed completely.
	Start button not pressed firmly or held long enough.	Press and hold the START button until you hear the drum start moving.
	Household fuse is blown or circuit breaker has tripped.	240V models: Electric dryers use two household circuit breakers. The drum may be turning, but the dryer will not have heat. Replace both fuses or reset the breakers. If the problem continues, call an electrician.
	Incorrect power supply.	240V models: Electric dryers require 240-volt power. Check with a qualified electrician.
	Wrong type of fuse.	Use a time-delay fuse.
Unusual sounds	Dryer had a period of non-use.	If the dryer hasn't been used for a while, there may be a thumping sound during the first few minutes of the cycle.
	A coin, button, or paper clip is caught between the drum and front or rear of the dryer.	Check the front and rear edges of the drum for obstructions. Clean out pockets before laundering.
	It is a gas dryer.	The gas valve clicking is a normal operating sound.
	The dryer is not level front to back and side to side.	The dryer may vibrate if not properly installed. See the Installation Instructions.
	Clothing knotted or balled up.	When balled up, the load will bounce, causing the dryer to vibrate. Separate the load items and restart the cycle.
No heat	Household fuse is blown or circuit breaker has tripped.	240V models: The drum may be turning, but the dryer will not have heat. Electric dryers use two household circuit breakers. Replace both fuses or reset the breakers. If the problem continues, call an electrician.

	Incorrect power supply.	240V models: Electric dryers require 240-volt power. Check with a qualified electrician.
Cycle time too short	Automatic cycle ending early.	120V models: The load may not be contacting the drum strips. Level the dryer.
		Use Timed Drying for very small loads. Check the Dryness Level setting on the Normal and Delicate cycles. Increasing or decreasing the Dryness Level will change the amount of drying time in a cycle.
Lint on load	Lint screen clogged.	Lint screen should be cleaned before each load.
Stains on load or drum	Dryer fabric softener not properly used.	Add dryer fabric softener sheets at the beginning of the cycle. Fabric softener sheets added to a partially full load may stain your garments.
		Drum stains are caused by dyes in clothing (e.g., jeans). These will not transfer to other clothes.
Loads are wrinkled	Load not removed from dryer at the end of the cycle.	Run the Air Only cycle to tumble the load without heat to remove wrinkling.
	Dryer tightly packed.	Dry smaller loads that can tumble freely to reduce the number of wrinkles forming.
Odors	You have recently been painting, staining, or varnishing in the area where your dryer is located.	Ventilate the area. When the odors or fumes clear, wash the area, rewash and dry the clothing.
	The dryer is being used for the first time.	The new electric heating element may have a burnt odor that will be gone after the first cycle.
Load is too hot	Laundry items were removed from the dryer before the end of the cycle.	All cycles are cooled slowly to reduced wrinkling and are easier to handle. Items removed before the end of the cycle are very warm.



A high temperature cycle was used.

Select a lower temperature, and use an auto cycle. These cycles sense the temperature or the moisture of the load and shut off when the load reaches the desired dryness. This reduces overdrying.

Warning

This content is compiled from multiple sources and is provided for reference purposes only. It may not be complete or fully applicable to all situations. If you are unable to resolve your issue, please contact the product manufacturer or an authorized service provider for official support.

