

Setting up your refrigerator

GETTING READY TO INSTALL THE REFRIGERATOR

Selecting the best location for the Refrigerator - Choose :

- A location with easy access to a water supply.
- A location without direct exposure to sunlight.
- A location with level (or nearly level) flooring.
- A location with enough space for the refrigerator doors to open easily.
- A location that allows sufficient space to the right, left, back, and top for air circulation. If the refrigerator does not have enough space, it can cause the bad influence to refrigeration efficiency and power consumption.
- A location that allows you to move the refrigerator easily if it needs maintenance or service.
- Do not install the refrigerator in locations where the temperature is over 110 °F (43 °C) or below 50 °F (10 °C).

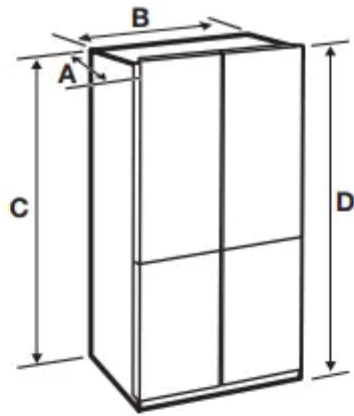

| | |
|---------------------------|-------------------|
| Depth "A" | 28 7/8" (733 mm) |
| Width "B" | 35 3/4" (908 mm) |
| Height "C" | 70 3/4" (1797 mm) |
| Overall Height "D" | 71 7/8" (1825 mm) |

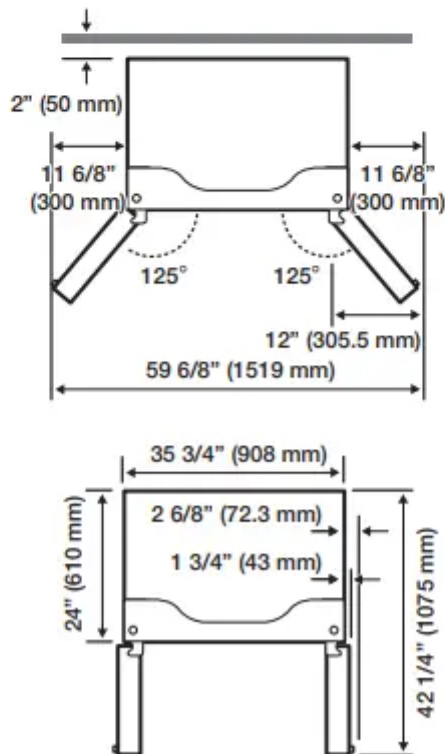

- Measurements reflect the design dimensions. The actual dimensions of your refrigerator may differ slightly



When moving your refrigerator

- To prevent floor damage, be sure the front leveling legs are in the up position (above the floor). Refer to “HOW TO LEVEL THE REFRIGERATOR”

Flooring



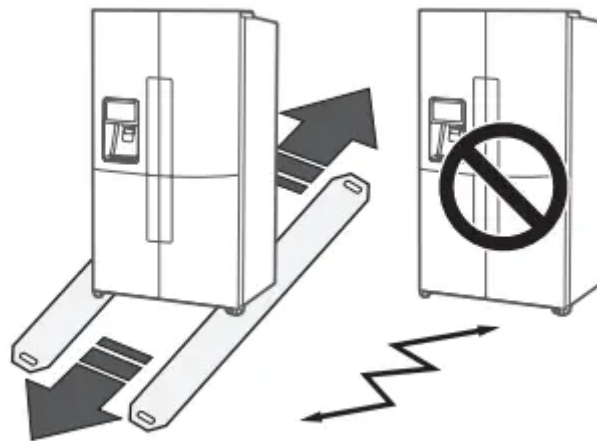



- For proper installation, you must place this refrigerator on a level, hard surface that is the same height as the rest of the floor.
- This surface should be strong enough to support a fully loaded refrigerator.
- To protect the finish of the flooring, cut out a large section of the cardboard carton and place it under the refrigerator where you are working.
- When moving the refrigerator, you need to pull and push it straight forwards or back.
- Do not wiggle it from side to side

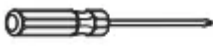

REMOVING THE REFRIGERATOR DOORS

If the refrigerator is too large to pass through your doorway easily, you can remove the refrigerator doors.

Tools you will need (Not provided)

| | | |
|---|---|--|
|  |  |  |
| Phillips screwdriver (+) | Flat-blade screwdriver (-) | Socket wrench (10 mm) |
|  |  |  |
| Pliers | Allen wrench (4 mm) | Allen wrench (5 mm) |

CAUTION

- Disconnect power to the refrigerator before removing the doors or drawers.
- Be careful not to drop, damage or scratch the doors/drawers while removing them.
- Use care when you remove the doors/drawers. The doors are heavy and you could injure yourself.
- Re-attach the doors/drawers properly to avoid:
 - Moisture from air leakage.
 - Uneven door alignment.
 - Wasting energy due to improper door seal.

DISASSEMBLING THE FRIDGE DOORS

1. With the door closed, remove the 3 screws holding the Top Cover (A) with a Phillips (+) Screwdriver, and then remove the Top Cover with the entire wire-harnesses attached

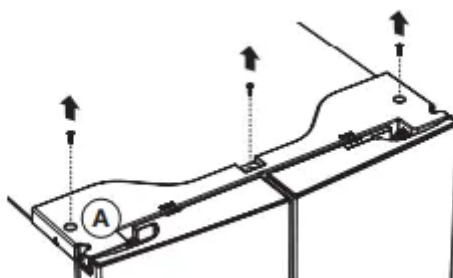

2. Separate the two connectors on the left door and the one connector on the right door. (B) Press the white sleeve (C) of the Water Tube Coupler, and then separate the Water Tube (D).

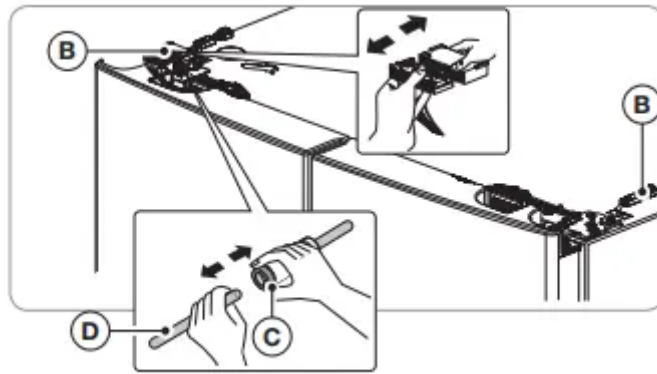

3. Pull up the Fixer Lever (E), and then pull it forward.

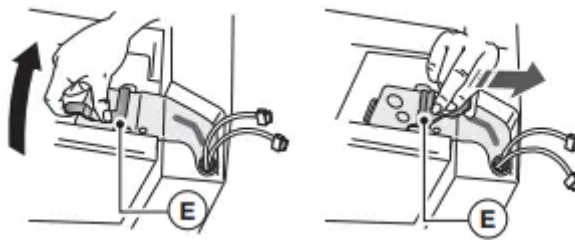

4. Remove the Hinge (F)

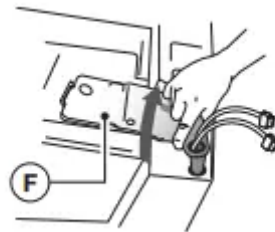

5. Lift up the Fridge Door and take it off.

CAUTION

- While disassembling and reassembling the door, make sure that the electric wires are not peeled off.
- Do not let the door fall down.

DISASSEMBLING THE FREEZER DOORS

CAUTION

- Be sure to remove the Fridge Door before removing the Freezer Door.
- Be careful with the wires attached to the bottom of the Freezer Door while disassembling.



1. With the door open, remove the screw holding the cover (A) of the Adjustable Leg at the bottom of the door with a Phillips (+) Screwdriver, and then disassemble the Connector (B).

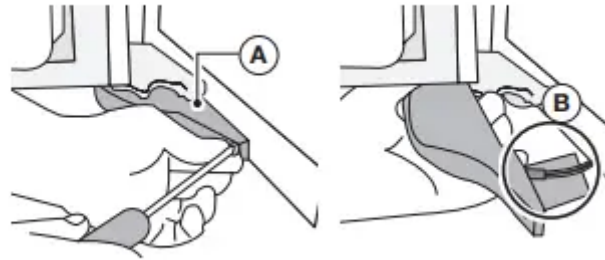

2. Lift up and remove the Mid Hinge Cap (C) on the Door Hinge above the Freezer Door.

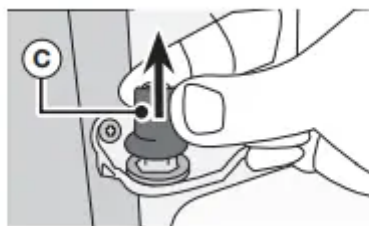

3. While pushing the door in the direction of the arrow, lift up the Mid Hinge Shaft (D).

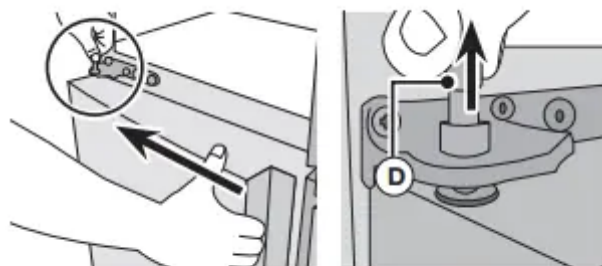

4. Being careful that the door does not touch the Mid Hinge (E), tilt the Door forward a little, and then lift it up to remove.

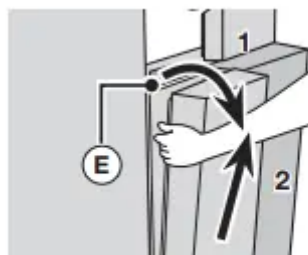

ASSEMBLING THE REFRIGERATOR DOORS

CAUTION

- Be sure to re-attach the Freezer Door before reattaching the Fridge Door.
- Before re-attaching, make sure that all the wire connectors at the bottom of the Freezer Door are connected.

How to Re-Attach the Freezer Door

1. Insert the door into the lower hinge (A) in the direction of (1) and then push the door in the direction of (2). Take care not to scratch the door with the MidHinge (B).

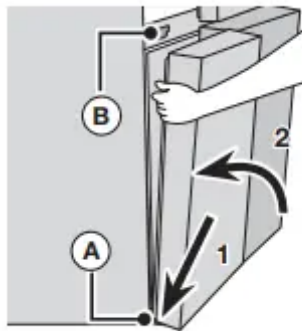

CAUTION: Be careful not to damage the wires on the bottom of the door. Avoid stepping on them, etc.

2. Insert the Hinge Shaft (C) into the Mid Hinge Hole (D) and put on the Hinge Cap (E). When assembling the Hinge Shaft and the Hinge Cap, be sure to assemble them in the correct direction.

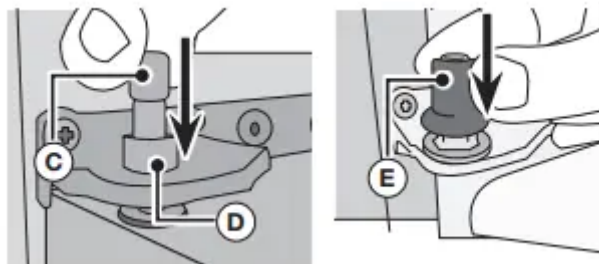

3. With the door open, join the connectors on the bottom of the door.

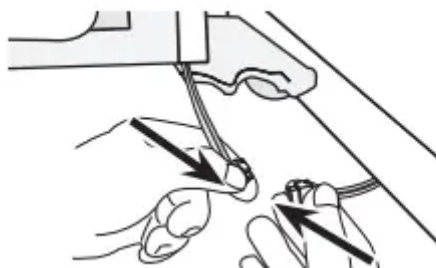

Be careful not to step on or damage the connectors.

4. Attach the Adjustable Leg Cover using a Phillips (+) Screwdriver.

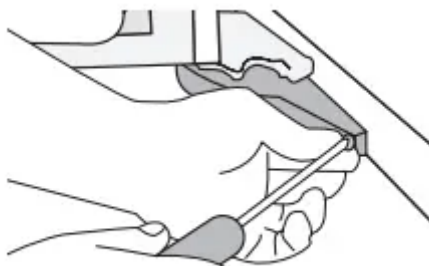

How to Re-Attach the Fridge Door

1. Attach the detached Fridge Door to the Mid Hinge.



2. Slide the Fridge Hinge (A) into the fixing slot, and then press it down so that it is aligned with the hole in the door.

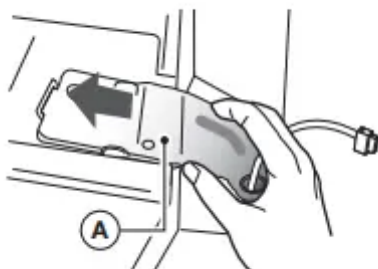

3. Inserting the Fixer Lever (B) in the direction of the arrow, and then flip it down to assemble.

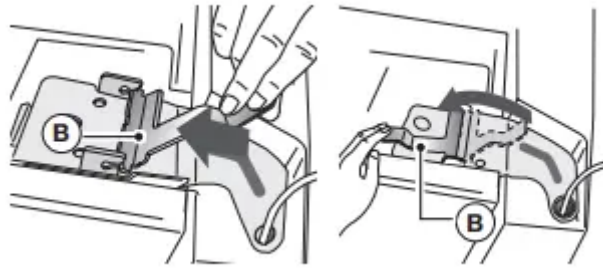

4. Assemble the Wire Connector.

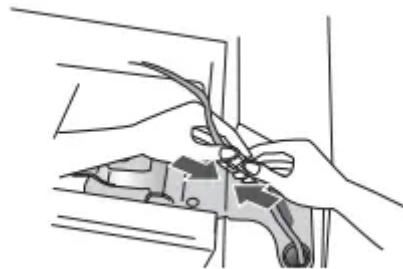

5. Connect the Water Tube (C). Connect the two connectors on the left door and the one connector (E) on the right door.

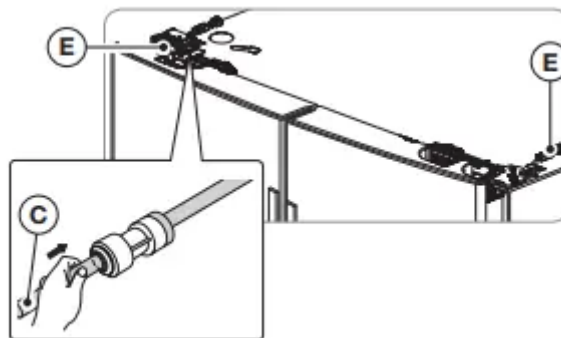

6. Attach the front of the Top Cover, and then press down on its back until it lies flat. Re-attach the screws.



CAUTION

- Assemble the Fridge and Freezer doors in the reverse order of disassembly.
- If the Wire Connectors are cross-assembled, the display will not work properly

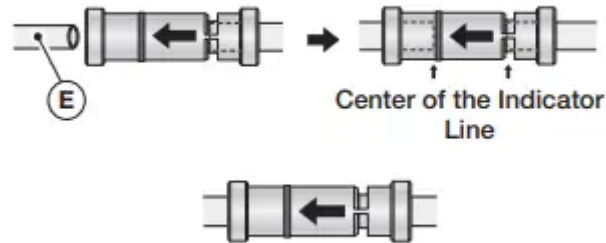

LEVELING THE REFRIGERATOR AND ADJUSTING THE HEIGHT AND GAP OF THE DOORS

How to level the refrigerator: To ensure your refrigerator is stable, install it on a flat, level surface and level it according to the instructions in this section. **CAUTION:** Failure to level the refrigerator may result in the refrigerator tipping over and causing personal injury.

- If the front of the refrigerator is slightly higher than the rear, the doors can be opened and closed more easily.
- When you install the refrigerator, make sure the adjustable legs touch the floor. The adjustable legs are located just behind the doors on the bottom front right and left corners of the refrigerator.

If the Refrigerator is on a floor that is not level, it can cause a height difference between the doors.

- Insert a Flat-Head (-) Screwdriver into the slot in the Leveling Leg Control Lever and adjust the level by turning the Control Lever clockwise or counter-clockwise. When you rotate the Lever clockwise, you raise the refrigerator. When you rotate the Lever counter-clockwise, you lower the refrigerator.

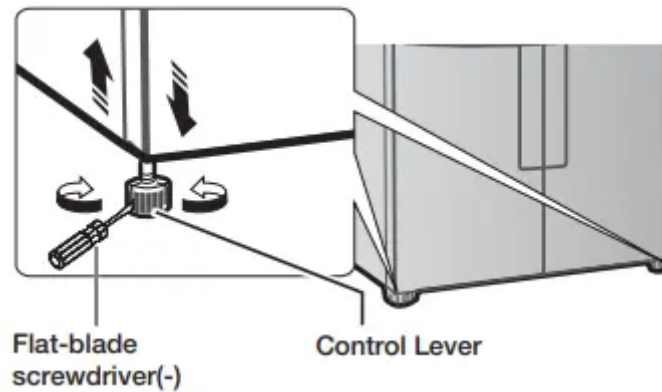

- If the Refrigerator is not level back and front, put a solid panel (such as a plastic panel, a plastic ruler, etc.) on the floor where the rear legs will rest, and then fix it in place with plastic tape. When you push in the Refrigerator, make sure the rear legs rest on the panel.
- If you have a wooden floor or similar soft floor, take care not to damage the floor when pushing the Refrigerator into place.

HOW TO ADJUST THE DOOR HEIGHT

If any one of the doors is lower than the other:

- Check if the Refrigerator is level before adjusting the door.

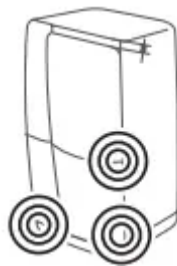

- Adjust the door height difference by inserting a Snap Ring (1) as shown between the door and the hinge. You can install a ring on the right side door of the fresh food compartment and both sides of the freezer compartment.

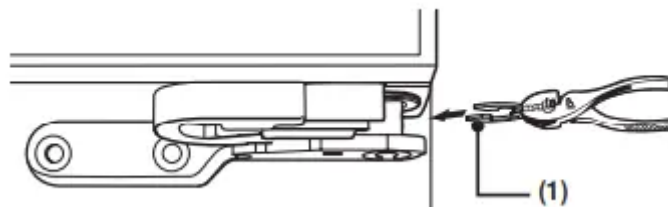

- After checking the height difference, select one Snap Ring with a suitable thickness. Insert that one Snap Ring only. Inserting two or more Snap Rings may cause the Snap Rings to slip out or make a rubbing noise.

- Lift up the lower door and insert the Snap Ring into the space between the Door and the Hinge.

CAUTION

- To avoid injury, insert or remove Snap Rings carefully.
- Keep the Snap Rings out of the reach of children and make sure that children do not play with them or put them into their mouths.
- 1 mm, 1.5 mm, 2 mm, and 2.5 mm Snap Rings come with the Refrigerator.
- If the Refrigerator is level before you load it with food, the Refrigerator may become unbalanced due to the weight of the food. If this occurs, adjust the level again using the same procedure.
- If you raise the door too far, it can rub against the Top Cover.

Snap Rings included with the refrigerator:

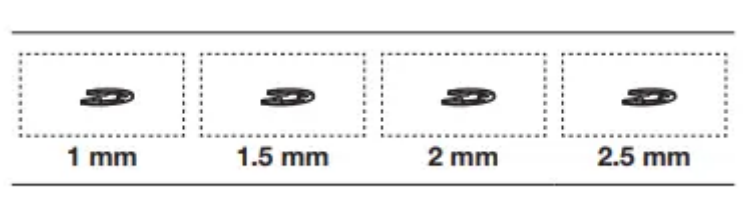

HOW TO ADJUST THE DOOR GAP

If the gap between the left and right fridge compartment doors is not even.

- You can adjust the gap by turning the bolt at the top right of the cold storage compartment door.
- Do not turn the bolt too far. You can break it.



1. With the doors closed, remove the 3 screws holding the top cover using a Phillips screwdriver, and then lift it off together with the connected cables.

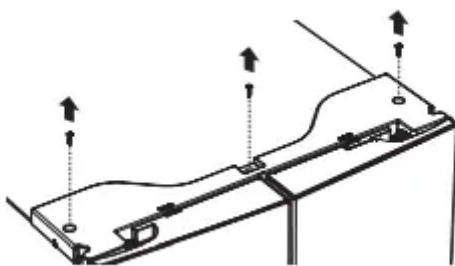

2. Turn the bolt with a 4 mm hexagonal L-wrench to adjust the gap.



3. Turn the bolt clockwise to (↻) widen the gap. Turn the bolt counterclockwise (↺) to narrow the gap.

INSTALLING THE WATER DISPENSER LINE

A water dispenser with a filter is one of the helpful features on your new refrigerator.

To help promote better health, the water filter removes unwanted particles from your water.

However, it does not sterilize or destroy microorganisms.

You may need to purchase a water purifying system to do that.

The water line also connects to the ice maker. For the ice maker to operate properly, water pressure of 20 ~ 125 psi is required.

If the refrigerator is installed in an area with low water pressure (below 20 psi), you can install a booster pump to compensate for the low pressure. After you have connected the water line, make sure the water storage tank inside the refrigerator is properly filled.

To do this, press the water dispenser lever until the water runs from the water outlet.

- Water line installation kits are available at extra cost from your dealer. We recommend using a water line installation kit that contains copper tubing and a 6 mm (¼") compression nut.
- Use the new hose-sets supplied with the appliance only. Do not re-use an old hose set.

Connecting to the water supply line

1. First, shut off the main water supply.



2. Locate the nearest cold water drinking line and install the pipe clamp and shut off valve.

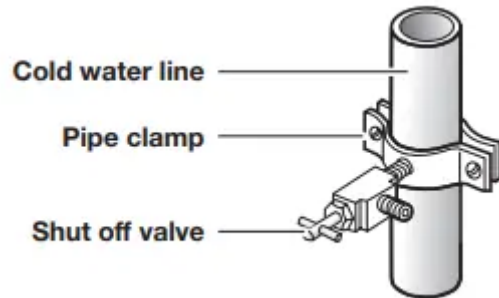

3. Connect the water line installation kit to the shut off valve.

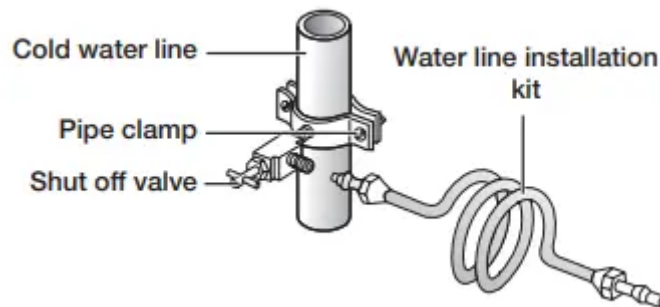

Connecting the water supply line to the refrigerator: There are several items that you need to purchase to complete this connection. You may find these items sold as a kit at your local hardware store.

Using Copper Tubing

- ¼" copper tubing
- ¼" compression nut (1pc)
- Ferrule (2pc)

Using Plastic Tubing

- ¼" plastic tubing → Molded end (Bulb)
- ¼" compression nut (1pc)

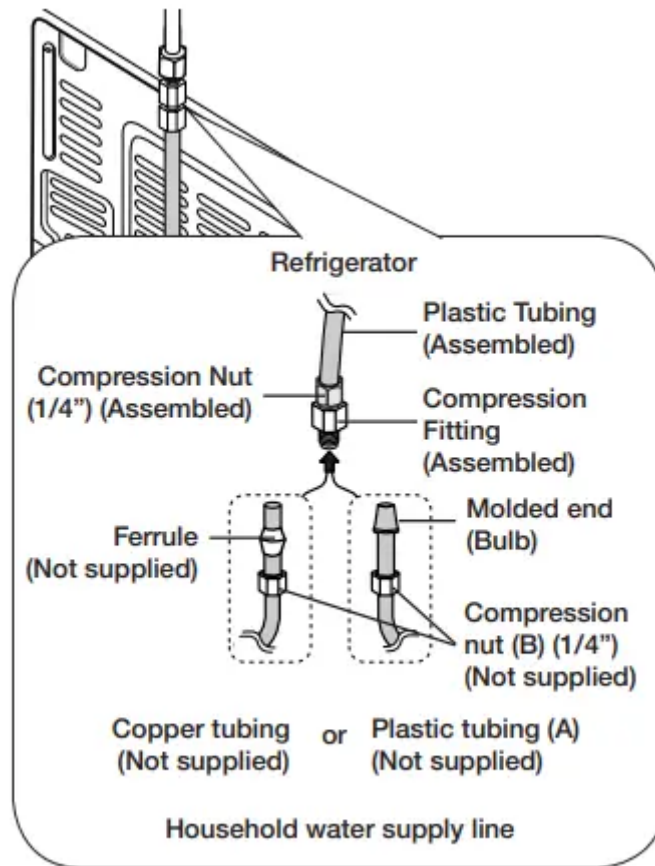

1. Connect the household water line to the assembled compression fitting.

- If you are using copper tubing, slip the compression nut (B) (not supplied) and ferrule (not supplied) on the copper tubing (not supplied) as shown.
- If you are using plastic tubing (A), insert the molded end (Bulb) of the plastic tubing (A) into the compression fitting.

CAUTION: Do not use without the molded end (Bulb) of the plastic tubing (A).

2. Tighten the compression nut (B) onto the compression fitting. Do not over-tighten the compression nut (B).

3. Turn the water on and check for any leakage. If you find water drops or leakage in the connection areas, turn off the main water supply. Check the connections and, if necessary, tighten.

4. Flush 1 gallon of water through the filter before drinking or using the water from the refrigerator. (Flush approximately 6 minutes.) To flush, press a large glass or cup against the water dispenser lever. Fill the glass, empty it into the kitchen sink after it is filled, and then repeat.

5. After you turn on the refrigerator, let the ice maker make ice for 1 to 2 days. Over that period of time, throw out the first 1 or 2 buckets of ice the freezer makes to ensure all impurities have been removed from the water line.

- Only connect the water line to a drinkable water source.

- If you have to repair or disassemble the water line, cut off 1/4" of the plastic tubing to make sure you get a snug, leak-free connection.
- You can test the water line quickly using a paper cup. Under normal conditions, the water dispenser can fill a 170 cc cup in about 10 seconds.

PRODUCT FEATURES

- TRIPLE COOLING - Separate condensers in the freezer, fresh food, and convertible compartments maintain optimum temperature and humidity in each compartment and prevent smells from one compartment leaking into another.
- FLEX ZONE - Lets you store food at various, user-selectable temperatures (Freezer, Soft Freezing, Chill, and Cool).
- Chill - Provides fixed temperature technology to keep food fresh.

Operating your Samsung refrigerator

USING THE CONTROL PANEL

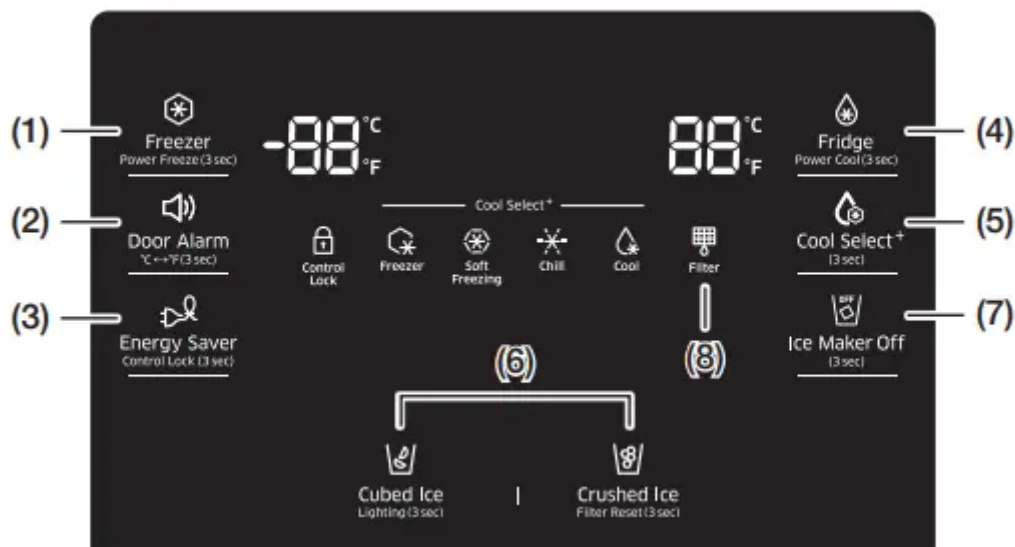

(1) Freezer (Hold 3 sec for Power Freeze)

- Touch this button to set the freezer to your desired temperature.
- You can set the temperature between -8 °F and 5 °F (between -23 °C and -15 °C). Touch and hold this button for 3 seconds to turn on Power Freeze and decrease the time needed to freeze products in the Freezer.

- This can be helpful if you need to quickly freeze easily spoiled items or if the temperature in the freezer has warmed dramatically. (For example, if the door was left open.)
- To cancel the Power Freeze function, press and hold the Freezer/Power Freeze (3 sec) button again for 3 seconds.



(2) Door Alarm (Hold 3 sec for °C ↔ °F)

This button serves two purposes:

1. To turn the door open alarm on and off If the door alarm is set to On, an alarm beeps if any refrigerator door is left open for more than two minutes. The beeping stops when you close the door. The door alarm function is pre-set to On in the factory. You can turn it off by touching and then releasing this button. You can turn it back on in the same fashion. The icon lights up when the function is on. When the Door Alarm function is on and the alarm sound is triggered, the Door Alarm Icon will blink while the alarm sounds.
2. Touch and hold this button for 3 seconds to switch the temperature units between °C and °F.”



(3) Energy Saver (Hold 3 sec for Control Lock)

- Touching this button turns Energy Saver mode on and off. When you turn Energy Saver on, the Energy Saver icon lights. Turn Energy Saver off and the icon goes off.
- The Energy Saver function is set to “ON” in the factory.
- If condensation or water drops appear on the doors, turn the Energy Saver mode off. Also, touching and holding this button for 3 seconds turns on Control Lock which locks the display panel and dispenser buttons so the buttons can not be used. The Control Lock icon lights up to indicate you've activated the Control Lock function. Touch and hold this button again for 3 seconds to turn Control Lock off.



(4) Fridge (Hold 3 sec for Power Cool)

- Touch this button to set the fridge to your desired temperature.
- You can set the temperature between 34 °F and 44 °F (between 1 °C and 7 °C). Touch and hold this button for 3 seconds turn Power Cool on and decrease the time needed to cool products in the Fridge. This can be helpful if you need to quickly cool easily spoiled items or if the temperature in the fridge has warmed dramatically.

- (For example, if the door was left open.) To cancel the Power Cool function, press and hold the Fridge/Power Cool (3 sec) button again for 3 seconds.



(5) Cool Select+ (Cool Select Room)

- The CoolSelect+ button lets you set the Cool Select Room on the bottom right of your refrigerator to one of four settings: Freezer, Soft Freezing, Chill, or Cool. Touch and hold the CoolSelect+ button for three seconds to activate the Cool Select Room function, and then touch the CoolSelect+ button repeatedly until the desired mode is selected.



Freezer

Select Freezer to set the same temperature as the freezer.

- Use this setting to keep frozen food.



Soft Freezing

Select Soft Freezing to set the temperature to 23 °F (-5 °C).

- Use this setting to keep meat and fish fresh longer than when in the fridge.



Chill

Select Chill to set the temperature of the Cool Select Room to 30 °F (-1 °C).



Cool

Select Cool to set the temperature to 41 °F (5 °C).

- Use this setting to keep drinks (juice, soft drinks, and beer), vegetables, fruit, etc. cool.



Cubed Ice
Lighting (3 sec)



Crushed Ice
Filter Reset (3 sec)

(6) Ice Type

- Touch the Ice Type button to change the ice type.

- Each time you touch the Ice Type button, the cubed and crushed ice modes alternate and the Cubed or Crushed ice icon lights up, indicating your selection. If you don't need ice, turn the function off to save on water and energy consumption. (See Ice Maker Off below.)

Lighting: Touch and hold the Cubed button for three seconds to set the Dispenser LED lamp (under the display) to continuous mode so that it stays on continuously. If you want the Dispenser lamp to come on only when some one uses the dispenser, touch and hold this button for 3 seconds again to turn the continuous mode off.

(7) Ice Maker Off (Hold 3 sec) 

-

Touch the Ice Maker Off button for 3 seconds until the Ice Maker Off Indicator () illuminates.

(8) Filter 

Water filter usage: This icon lights when you need to change the filter, usually after the refrigerator has dispensed about 300 gallons of water (after about 6 months). The icon will blink red for several seconds when you open or close the door. After you install the new water filter, touch and hold the Crushed Ice button for 3 Seconds to reset the filter.

- If water is not dispensing or dispensing slowly, you need to replace the water filter because the water filter is clogged.
- Some areas have large amounts of lime in their water, which causes the water filter to clog more quickly.

Exhibition Mode



CAUTION

- Exhibition Mode is designed for use by retailers when they are displaying refrigerators on the shop floor. In Exhibition Mode, the refrigerator's fan motor and lights work normally, but the compressors do not run, and the refrigerator and freezer do not get cold. To start Exhibition Mode, touch and hold the Freezer, Fridge, and Door Alarm buttons at the same time for 5 seconds during normal operation. The refrigerator chime sounds. To cancel Exhibition Mode, touch and hold the Freezer, Fridge, and Door Alarm buttons at the same time again for 5 seconds. The refrigerator chime sounds once more.

CHANGING THE WATER FILTER

WARNING: To reduce risk of water damage to your property **DO NOT** use generic brands of water filters in your SAMSUNG Refrigerator.

USE ONLY SAMSUNG BRAND WATER FILTERS. SAMSUNG is not legally responsible for any damage, including, but not limited to, property damage caused by water leakage from the use of a generic water filter.



(Red)

SAMSUNG Refrigerators are designed to work **ONLY WITH SAMSUNG** Water Filters. The Filter light turns red to let you know when it is time to change your water filter cartridge. To give you time to get a new filter, the red light comes on just before the capacity of the current filter runs out.

Changing the filter on time provides you with the freshest, cleanest water from your refrigerator.

1. Shut off the water supply. Then, turn the water filter (1) about 1/4 turn, counter-clockwise.
2. Pull the water filter (1) out of the case filter (2).

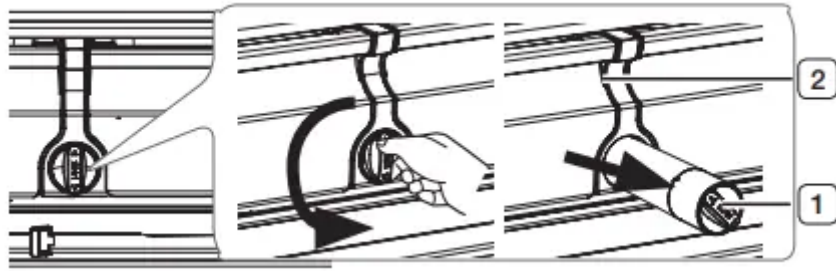

- To change the water filter more easily, shut off the water supply valve.
- Sometimes, it is hard to disassemble the water filter because impurities in the water cause it to stick. If you are having difficulties, grip the water filter firmly and pull it hard.
- When you pull out the water filter, a little water can leak from the opening. This is normal. To minimize the water leaks, keep the filter cartridge horizontal when you pull it.
- To prevent overflow, empty the water filter tray (3) and dry around the filter case (2).

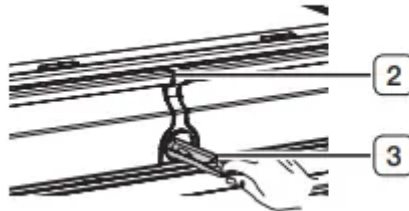

3. Insert the new filter into the filter case (4).

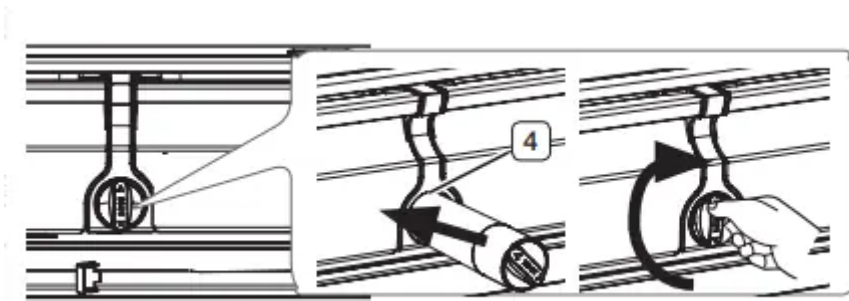

4. Push the filter in, and then turn it clockwise until it locks.



- If you have trouble inserting the water filter because of high water pressure, shut off the water supply valve.

- The locked symbol should be lined up with the indicator line.



5. Touch the “Crushed/Hold 3 sec for Filter Reset” button () for about 3 seconds to reset the water filter. The color of the indicator changes from red to off.

6. If you turned off the water supply, turn it back on.

- For a replacement water filter, visit your local home Improvement center, go to Samsung Parts.com on line, or contact your authorized Samsung dealer. Be sure the replacement water filter has the SAMSUNG logo on the box and on the water filter.

Removing any residual matter inside the water supply line after installing the water filter.

1. Turn ON the main water supply and supply water from water supply line.
2. Run water through the dispenser until the water runs clear (approx. 6 to 7 minutes). This will clean the water supply system and remove air from the lines.
3. Additional flushing may be required in some households.
4. Open the Refrigerator door and make sure there are no water leaks coming from the water filter.

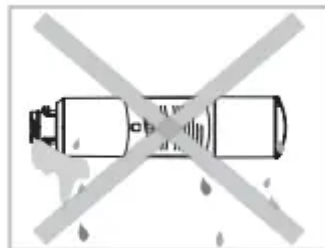

Be sure to flush the dispenser thoroughly, otherwise water may drip from the dispenser. If water drips, it means that there is still air in the line.

Reverse Osmosis Water Supply - IMPORTANT: The pressure of the water supply coming out of a reverse osmosis system going to the water inlet valve of the refrigerator needs to be between 241 and 827 kPa. If a reverse osmosis water filtration system is connected to your cold water supply, the water pressure to the reverse osmosis system needs to be a minimum of 276 to 414 kPa. If the water pressure to the reverse osmosis system is less than 276 to 414 kPa:

- Check to see whether the sediment filter in the reverse osmosis system is blocked. Replace the filter if necessary.
- Allow the storage tank on the reverse osmosis system to refill after heavy usage.
- If your refrigerator has a water filter, it may further reduce the water pressure when used in conjunction with a reverse osmosis system. Remove the water filter.

If you have questions about your water pressure, call a licensed, qualified plumber.

CONTROLLING THE TEMPERATURE

Recommended freezer and fridge compartment temperatures

- The recommended temperatures for the Freezer and Fridge Compartments are 0 °F and 37 °F (-18 °C and 3 °C) respectively.
- If the temperature of the Freezer and Fridge Compartments are too high or low, adjust the temperature manually

CONTROLLING THE FREEZER TEMPERATURE



Recommend Temp (Freezer) : 0 °F (-18 °C)

Freezer

- The Freezer temperature can be set between -8 °F and 5 °F (or between -23 °C and -15 °C) to suit your particular needs. The default temperature is 0 °F (-18 °C).
- Press the Freezer button repeatedly until the desired temperature is shown in the temperature display.
- The temperature will change by 1 °F (or 1 °C) with each press in the order shown below.
- Fahrenheit : 0 °F → -1 °F → -2 °F → -3 °F → -4 °F → -5 °F → -6 °F → -7 °F → -8 °F → 5 °F → 4 °F → 3 °F → 2 °F → 1 °F → 0 °F. Centigrade : -18 °C → -19 °C → -20 °C → -21 °C → -22 °C → -23 °C → -15 °C → -16 °C → -17 °C → -18 °C.

The Freezer or Fridge temp indicator will blink when the temperature in the fridge or freezer compartment goes up dramatically. The Freezer or Fridge temperature indicator will stop blinking when the temperature in the freezer or fridge returns to normal. If the temperature indicator does not stop blinking after several hours, please contact Samsung Customer Care or your nearest Samsung service center.

Power Freeze

- The Power Freeze function substantially speeds up the freezer compressor, causing the freezer to cool down rapidly to a temperature you choose.

- When you touch and hold the Freezer button for 3 seconds, Power Freezer function will be activated. Power Freeze is useful if you need to quick freeze an item, to make a large quantity of ice, or to cool the freezer rapidly if it has warmed dramatically (for example, if the door was left open).
- To turn the Power Freeze function off manually, press the Freezer button, and then re-set the Freezer temperature.
- Power Freeze turns off automatically after 50 hours to decrease energy consumption.
- When you use this function, the energy consumption of the refrigerator will increase. If you need to freeze large amounts of food, activate the Power Freeze function at least 20 hours before.

CONTROLLING THE FRIDGE TEMPERATURE



Recommend Temp (Fridge) : 37 °F (3 °C)

The Fridge temperature can be set between 34 °F and 44 °F (or between 1 °C and 7 °C) to suit your particular needs. The default temperature is 37 °F (8 °C).

Press the Fridge button repeatedly until the desired temperature is shown in the temperature display. The temperature will change by 1 °F (or 1 °C) with each press in the order shown below.

Fahrenheit : 37 °F → 36 °F → 35 °F → 34 °F → 44 °F → 43 °F → 42 °F → 41 °F → 40 °F → 39 °F → 38 °F → 37 °F. Centigrade : 3 °C → 2 °C → 1 °C → 7 °C → 6 °C → 5 °C → 4 °C → 3 °C.

- The temperature of the Freezer, Fridge or Cool Select Room may rise when you open the doors too frequently, or if a large amount of warm or hot food is placed inside.
- This may cause the digital display to blink. Once the Freezer and Fridge temperature return to their normal set temperatures, the blinking will stop.
- If the blinking continues, you may need to “reset” the Refrigerator. Try unplugging the appliance, wait for around 10 minutes, and then plug the power cord back in.
- If there is a communication error between the Display and Main Controller, the Display light may blink “PC-Er” and the refrigerator will beep. If the blinking continues for a long period of time, please contact a Samsung Electronics Service Center.

USING THE ICE AND COLD WATER DISPENSERS

Push the Cubed or Crushed Ice button to select the ice you want dispensed

Using the ice lever (1)

- Push the Ice lever dispenser (1) gently with your glass. Ice will be released from the dispenser. You can choose the type of ice by pushing the cubed or crushed button first.

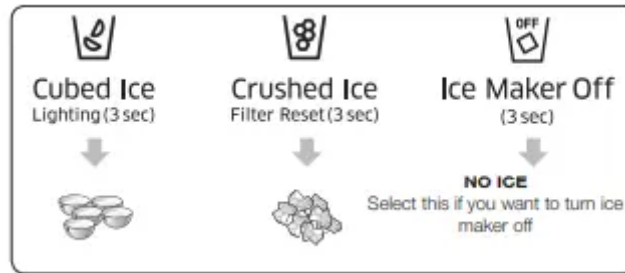

Using the Water lever (2)

- Push the Water lever dispenser (2) gently with your glass. Water will be released from the dispenser.

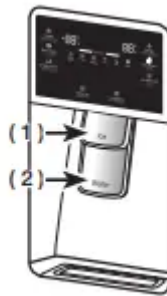

- If you push the water and Ice lever at about the same time, the dispenser operates only the option you actually selected or pushed first.
- Please wait 1 second before removing the cup after dispensing water to prevent spills. Do not pull out the lever dispenser after dispensing ice or water. It comes back automatically.

Using the Ice & Water Dispenser together

- To get Ice and water, push the Ice lever (1) first for ice, then move your glass down and press the water dispenser lever (2) for water.

MAINTAINING THE ICE BUCKET

- To clean the ice bin/bucket, wash with a mild detergent, rinse well, and dry thoroughly. Do not use harsh or abrasive cleaners or solvents.

- Ice is made in cubes. When you select “Crushed”, the ice maker grinds the ice cubes into crushed ice.
- When you select Cubed Ice after using the Crushed Ice mode, a small amount of residual crushed ice might be produced.
- The ice cubes generated by the rapid ice making process will look white, which indicates they are generated normally.
- If ice doesn’t come out, pull out the ice bucket and press the Test button located on the right side of ice maker. See the illustration under Making Ice below.
- Do not press the Test button continuously if the tray is filled with ice or water. Water may overflow or ice may jam the bucket.

MAKING ICE

To fill the ice bucket to maximum capacity after installation, follow these steps:

1. Allow your refrigerator to operate and cool down for 24 hours (or 1 full day). Waiting 24 hours will allow your ice maker to cool properly.
2. Dispense 4 to 6 ice cubes into a glass.
3. Wait 8 more hours, and then dispense a full glass of ice.
4. Wait 8 additional hours, and then dispense another full glass of ice.

To test the ice maker, press the Test button on the ice maker. You will hear the refrigerator chime (ding-dong). When the chime sounds, release the Test button.

The chime sounds automatically again to let you know the ice maker is working well.

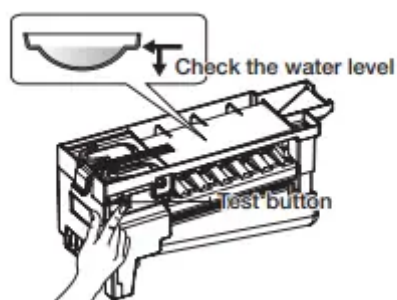

CAUTION: If you want to remove ice cubes without removing the ice bucket, turn the ice maker off. and then remove the front cover from the ice maker. The ice cubes in the ice maker can spill out over the drawer, so remove the ice cubes carefully.

CAUTION: Do not put food in the ice bucket. If you store food in the ice bucket, the food may get in the way of the ice maker when you open or close the door, causing damage to the ice maker.

CAUTION: Note that the ice cubes in the ice bucket may spill out over the drawer when you remove the ice bucket from the drawer. If this occurs, be sure to pick up the ice cubes that have spilled out of the drawer.

CAUTION: If a power failure occurs, ice cubes may melt then freeze together when the power comes back on and prevent the dispenser from working properly.

To prevent this problem, after a power failure, pull out the ice bucket and discard the residual ice or water.

If you use all the ice at once, you must repeat Steps 2, 3, and 4 on the previous page under Making Ice. However, only wait 8 hours before dispensing the first 4 to 6 ice cubes. This will replenish the ice cubes and ensure maximum ice production.

USING THE ICE OFF FUNCTION

- When you select the Ice Off mode, remove all ice cubes from the bucket.
- If you leave the ice cubes in the bucket, the ice cubes may clump together, making it difficult to remove them.
- To remove the ice bucket safely and avoid injury, hold the bottom of the bucket with one hand and the side of the bucket with the other. Then, lift up on the ice bucket, and pull it straight out.
- To put the ice bucket back in, push it firmly straight back. If the ice bucket is not pushed firmly into place, ice in the bucket can melt.
- If the bucket does not fit, turn the helix 90 degree (see the last illustration on the right, below) and try again.

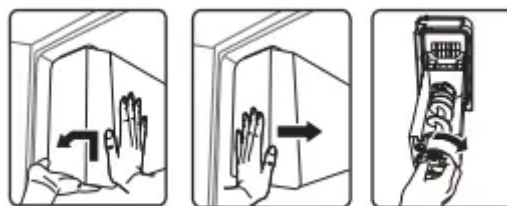

CAUTION

- The inside of the ice bucket is very cold when the refrigerator is operating. Do not reach deep inside the ice bucket.
- Use only the ice maker provided with the refrigerator.
- Have the refrigerator's water supply connected only to a potable water supply.
- To operate the ice maker properly, water pressure of 20 ~ 125 psi is required.

GOING ON VACATION...

If you are going on a long vacation or business trip and won't use the water or ice dispensers for a long time:

- Close the water valve. Otherwise, water leakage may occur.
- Remove all food and the ice in the ice bucket.
- Unplug the refrigerator.
- Wipe excess moisture from inside and leave the doors open. Otherwise, odor and mold may develop.

ICE MAKER DO'S AND DON'TS

Do not put your fingers, hands or any other unsuitable objects in the chute or ice-maker bucket.

- You can hurt yourself or damage the refrigerator. Never put your finger or any other objects in the dispenser opening.
- You can injure yourself. Do not try to disassemble the ice maker. Do not wash or spray the ice bucket with water while it is in the refrigerator. Remove it to clean it.

CAUTION: When you insert the Ice maker tray, be sure that the tray is well centered at the entrance. Otherwise, the tray may get stuck.

Water clouding phenomenon

- All water provided to the refrigerator flows through a core alkaline water filter. In the filtering process, the pressure of the water that has flowed out of the filter has increased, and the water has become saturated with oxygen and nitrogen. When this water flows out into the air, the pressure plummets and the oxygen and nitrogen get supersaturated, which results in gas bubbles. The water may temporarily look misty or cloudy due to these oxygen bubbles. After a few seconds, the water will look clear.

PARTS AND FEATURES

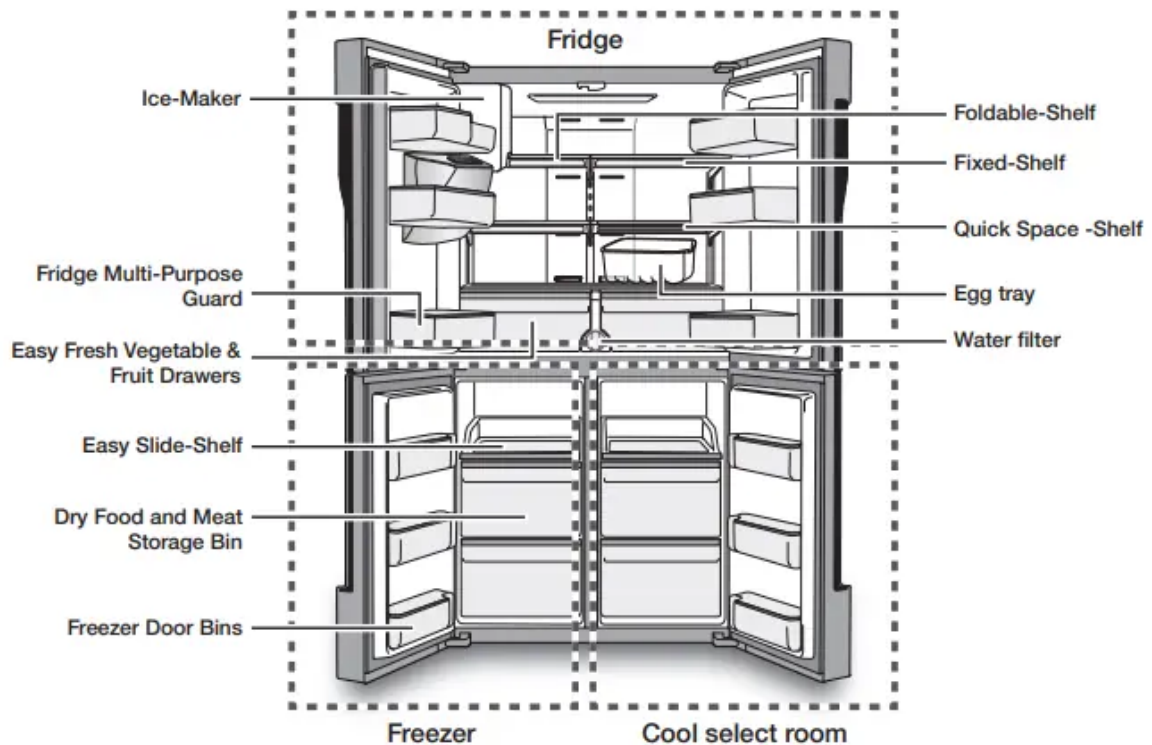

- When closing the door, make sure the Vertical Hinged Section is in the correct position to avoid scratching the other door. If the Vertical Hinged Section is reversed, put it back into the correct position, and then close the door. Moisture may appear at times on the Vertical Hinged Section. The door handle may become loose over time. If this happens, tighten the bolts found on the inside of the door. If you close one door with too much force, the other door may open.
- When the door opens, the interlock switch automatically turns off the auger motor in the ice maker for safety reasons.
- If the interior or exterior LED lamp has gone out, please contact Samsung service.

Door bins: Your refrigerator ships with door bins of different types and sizes. If the door bins for your refrigerator were packaged separately, use the figure below to help you position the bins properly. The number of door bins provided may differ with the model.

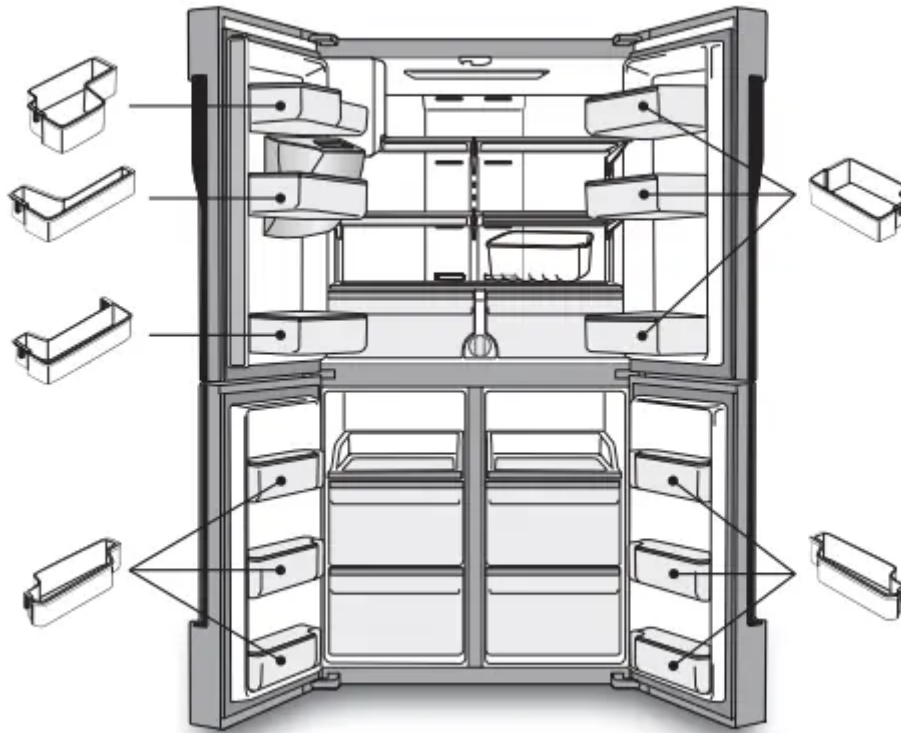

REMOVING THE REFRIGERATOR ACCESSORIES

1. Door Bins or Guards Compartment

- To remove - Simply lift the bin up and pull straight out.
- To relocate - Slide it in above the desired location and push down until it stops.

CAUTION

- Injuries can occur if the door bins are not firmly attached to the doors. Do not allow children to play with the bins. Sharp corners of the bins may cause injury.
 - Do not adjust a bin full of food. Remove the food first.

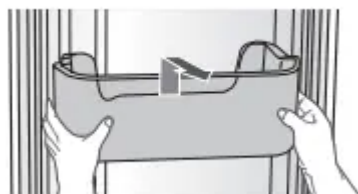

- Dust removal method - Remove the guard and wash in water.
- If it is stained with oil after use, wash in water right away.

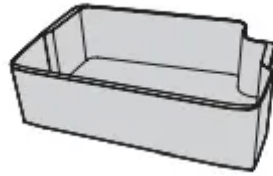

2. Tempered Glass shelves

- To remove - Tilt up the front of the shelf in the direction shown (1) and lift it up vertically (2). Pull the shelf out.
- To relocate - Tilt the front of the shelf up and guide the shelf hooks into the slots at a desired height. Then, lower the front of the shelf so that the hooks can drop into the slots.

CAUTION: The Tempered Glass shelves are heavy. Use special care when removing them.

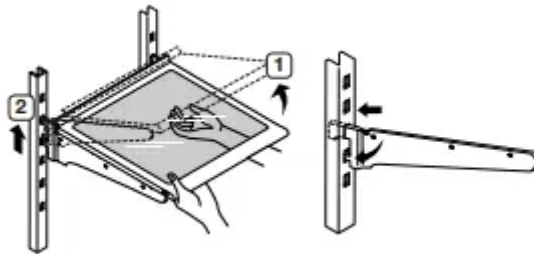

3. Vegetable & Fruit Drawers (EZ Fresh Zone)

- Holding the drawer with one hand, lift it up a little bit while pulling it forward, and then pull it out of the refrigerator.
- Remove the door bins before removing the drawer to prevent damage to the door bins.

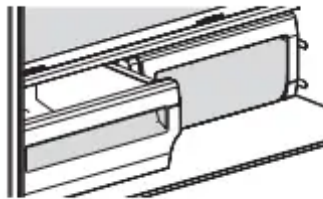

CLEANING THE REFRIGERATOR

WARNING

- Do not use benzene, thinner, Clorox, or car detergent to clean the refrigerator. They can damage the surface of the appliance and may cause a fire.

- Do not spray the refrigerator with water while it is plugged in. This can cause an electric shock.
- To clean the refrigerator, follow these steps:

1. Unplug the power cord of the refrigerator.
2. Slightly dampen a soft lint-free cloth or paper towel with water. Do not use any kind of detergent to clean the refrigerator because that can discolor or damage the refrigerator.
3. Wipe the inside and outside of refrigerator until it is clean and dry.
4. Plug the power cord of the refrigerator back in.

CHANGING THE INTERIOR LIGHTS

Freezer / Fridge LED Lamp

- If the LED Lamp Cover is stained with foreign substances, the LED lamp may not look bright. Wipe the surface cover with clean dry cloth to return the light to full brightness.
- CAUTION: Do not disassemble or replace the LED type lighting yourself. To replace the LED lights, contact a Samsung service center or your authorized Samsung dealer.
- If you attempt to replace the LED lamps yourself, you risk subjecting yourself to an electric shock or serious personal injury.

Troubleshooting

1. The refrigerator does not work at all or it does not chill sufficiently
 - Check if the power plug is properly connected.
 - Check if the set temperature on the digital display is warmer than the freezer or fridge inner temperature. If it is, set the freezer or fridge to a colder temperature.
 - Is the refrigerator in direct sunlight or located near a heat source? If so, it may not be able to cool sufficiently. Install it in a location that is out of direct sunlight and not near a heat source.
 - Is the back of the refrigerator too close to the wall, preventing proper ventilation? If so, it may not be able to cool sufficiently. Keep it an appropriate distance from the wall.
 - Is there too much food inside so that the food is blocking the outlet vent? To keep the refrigerator at a suitable temperature, do not fill the refrigerator with too much food.
2. The food in the fridge is frozen.
 - Check if the set temperature on the digital display is too low. If so, raise the set temperature inside the refrigerator.
 - Is the temperature in the room too low? Set the refrigerator warmer.

- Did you store food with a high moisture content in the coldest part of the refrigerator or near the cooling outlet vent? Try moving those items to the other shelves in the fridge instead of keeping them in the colder areas or bins.

3. You hear unusual noise or sounds.

- Check if the refrigerator is level and stable.
- Is the back of the refrigerator too close to the wall, preventing proper ventilation?
- Was anything dropped behind or under the refrigerator?
- If you hear a “ticking” sound from inside the refrigerator, this is normal. It occurs because various parts contract or expand in response to temperature changes in the refrigerator interior.
- If it sounds as if something is hitting something else inside the refrigerator, this is normal. The sound is caused by the compressor operating at high capacity.

4. The cabinet-door sealing area of the appliance is hot and condensation is occurring.

- Some heat is normal as anti-condensators are installed in the vertical hinged section of the refrigerator to prevent condensation.
- Is the refrigerator door ajar? Condensation can occur when you leave the door open for a long time.

5. The Ice Maker is not producing ice.

- The refrigerator may take longer to make ice if it is not sufficiently cool, such as when first installed.
- Is the water line connected and the shut-off valve opened?
- Did you manually stop the ice making function?
- Check if the filter is properly installed. If it is not properly installed, the ice making function may not work.

6. You can hear water bubbling in the refrigerator.

- This is normal. The bubbling comes from refrigerant circulating through the refrigerator.

7. There is a bad smell in the refrigerator.

- Check for spoiled food.
- Foods with strong odors (for example, fish) should be tightly covered.
- Clean out your freezer periodically and throw away any spoiled or suspicious food.

8. Frost forms on the walls of the freezer.

- Is the air vent blocked? Remove any obstructions so air can circulate freely.
- Allow sufficient space between the stored food for efficient air circulation.
- Is the freezer drawer closed properly?

9. The water dispenser is not functioning.

- Is the water line connected and the shut-off valve opened?
- Has the water supply line tubing been crushed or kinked?
- Make sure the tubing is free and clear of any obstruction.
- Is the water tank frozen because the fridge temperature is too low? Try selecting a warmer setting on the Digital display.
- Check if the filter is properly installed. If it is not properly installed, the water dispenser may not work.

10. The auto close system does not work with the freezer door.

- Is there an imbalance between the right and left parts of the door?
- Open and close the door smoothly 1~2 times. After you do this, the auto close system usually works properly again.
- Try opening the door smoothly to avoid unbalancing the right part and the left part of the door.

11. Condensation or water drops forms on vertical mullion and surroundings, etc.

- Condensation or water drops may form if the humidity is too high while the refrigerator is operating.
- If condensation or water drops appears on vertical mullion and surroundings, etc., turn the Energy Saving mode off after removing the condensation.

Warning

This content is compiled from multiple sources and is provided for reference purposes only. It may not be complete or fully applicable to all situations. If you are unable to resolve your issue, please contact the product manufacturer or an authorized service provider for official support.