

## Getting started - Washer

WARNING: To reduce the risk of fire, electric shock, or injury to persons, read the IMPORTANT SAFETY INFORMATION before operating this appliance.

Throughout this manual, features and appearance may vary from your model

Step 1:

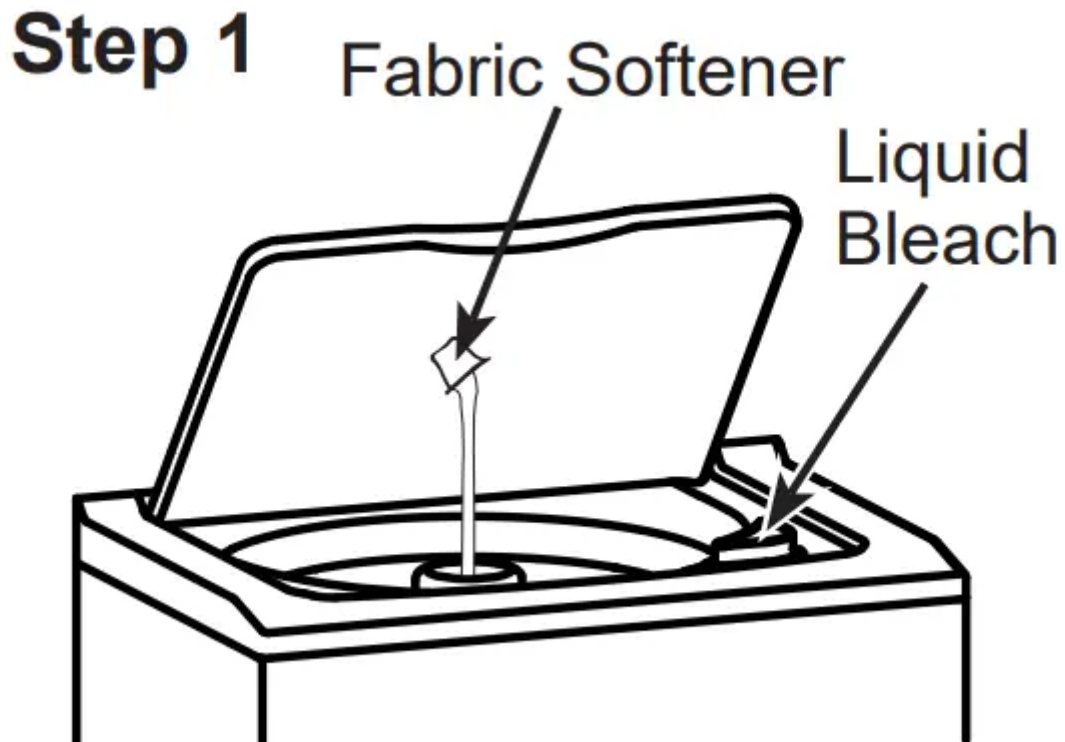

- Add fabric softener (optional)
- Add bleach (optional).

Step 2

## Step 2

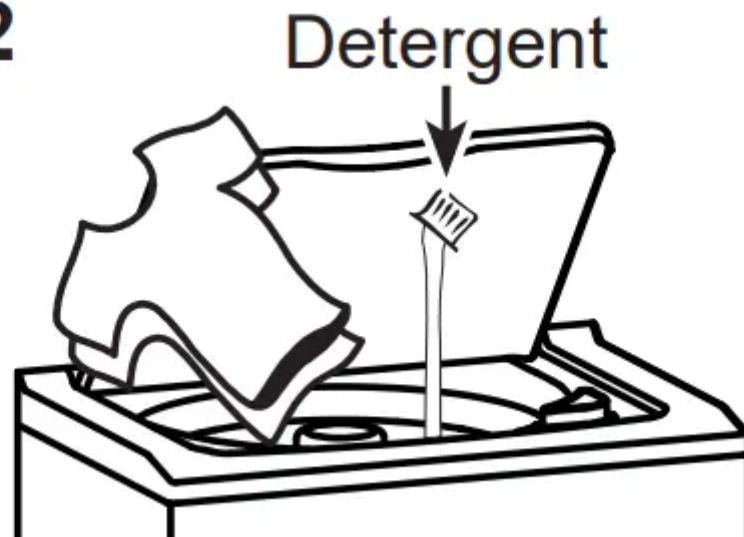

- Loosely add items. Overloading may negatively impact wash performance.
- Add detergent

## Step 3

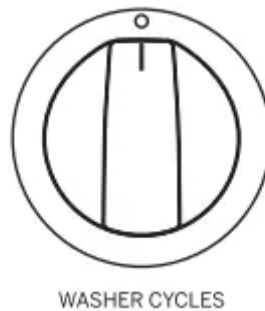

- Turn the WASHER CYCLES knob to “wake up” the washer before each use. The LED lights will turn on when the washer is awake and ready to use.
- Select desired wash cycle.
- Select additional settings.

## Step 4



- Close lid.
- Press the Start button.

## Washer models: GUD27EESN - With an Infusor

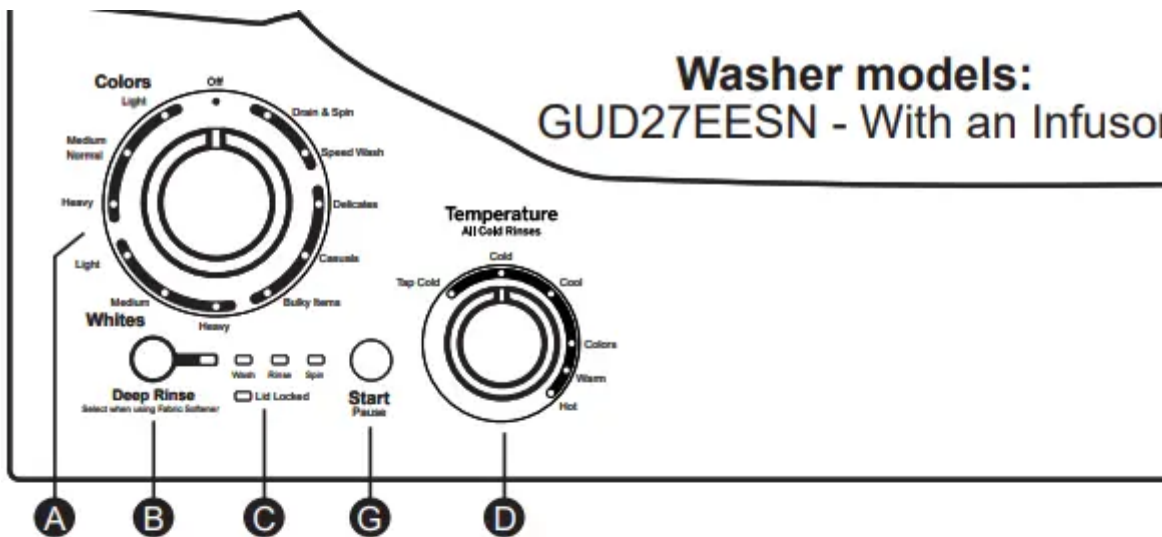

## Washer models: GUD27 - With an Agitator GUV27 - With an Agitator

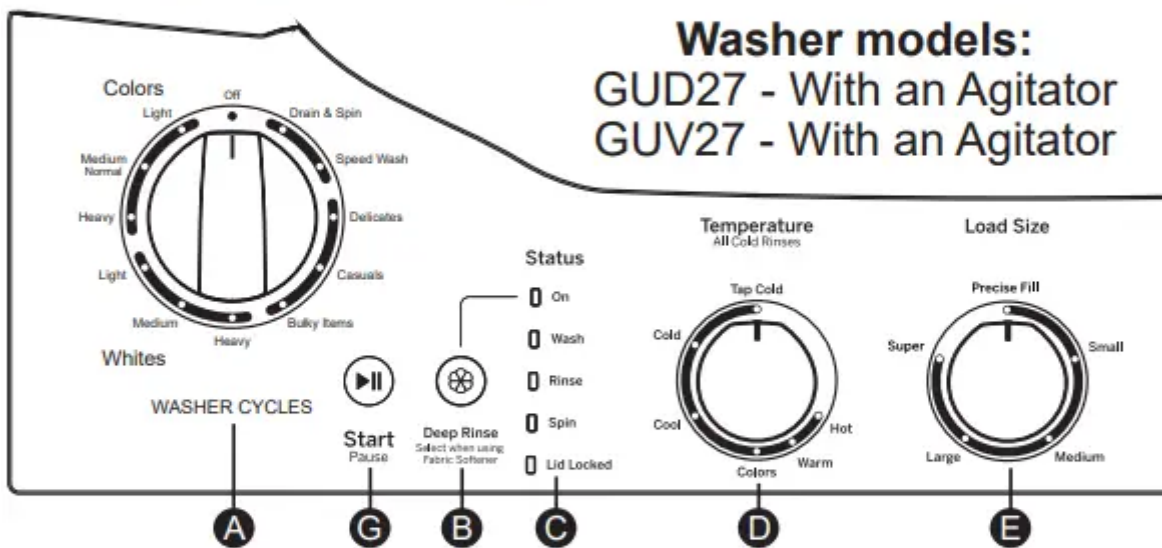

## Washer model: GUD24 - With an Agitator

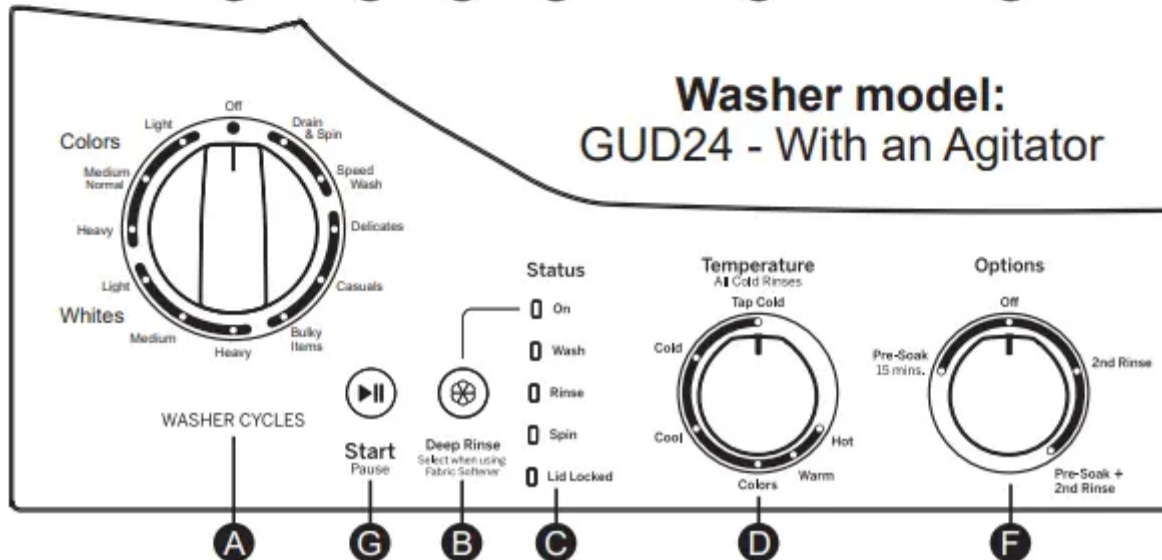

NOTE: This appliance is designed so that the washer and dryer can be operated at the same time.



## LID LOCKED

- Your washer has a security system that prevents opening the lid during the spin cycle. The lid lock prevents anyone (especially children) from reaching into the washer while the basket is spinning. The lid lock will release within 5 seconds after the basket stops spinning.
- Trying to open the lid while locked could result in injuries. If the lid does not unlock after spinning, please contact service.
- NOTE: If there is a power outage the lid lock can take 3 minutes to release.

### A Washer Cycles:

- The washer cycle controls the type of washing process. The cycle selector knob can be turned in either direction. Turning the knob after starting a cycle will stop the washer and change the cycle to the new selection. Press Start to begin the new cycle selection.
- The chart below will help you match the items to be washed with the best washer cycle settings. For optimal performance, select the cycle that most closely matches the items being washed. Selections shown in bold are the recommended settings for that cycle.
- Off - Washer is turned off and the Start button does not function. NOTE: When the control is turned to Off, the Status lights are off.
- NOTE: The cycle selector does not rotate during the operation of the washer.

### Items to Wash -- Cycle -- Wash -- Temp -- Cycle Details

1. Cycle for normal, regular, or typical use for washing up to a full load of normally soiled cotton clothing. -- Colors Medium/ Normal -- Hot Warm Colors Cool Cold Tap Cold

- Use Colors Medium/Normal cycle for normal, regular, or typical use for washing up to a full load of normally soiled cotton clothing. Choose the Warm or Hot water temperature selection as appropriate for your clothes load for a higher degree of cleaning. Incorporates multi-stage fills and wash periods to provide optimal fabric care.

2. Whites and household linens -- Whites -- Hot Warm Colors Cool Cold Tap Cold

- Cycle tailored to clean and brighten your whites.

3. Large coats, bed spreads, mattress covers, sleeping bags, and similar large bulky items. -- Bulky Items -- Hot Warm Colors Cool Cold Tap Cold

- Provides a max fill wash water level to wash bulky items. Also incorporates a deep fill rinse to effectively rinse bulky items.

4. Casual clothes, lightly soiled office wear. -- Casuals -- Hot Warm Colors Cool Cold Tap Cold

- Wash cycle tailored to care for casual clothes and office wear items. Incorporates multi-stage fills and wash periods to provide optimal fabric care.

5. Lingerie and special care fabrics with light soil. -- Delicates -- Hot Warm Colors Cool Cold Tap Cold

- Utilizes a gentle agitate profile and a low spin speed to provide special care to delicate fabrics. It is recommended to place small or ultra delicate items in mesh bags before washing.

6. Small loads of lightly soiled items that are needed in a hurry. -- Speed Wash -- Hot Warm Colors Cool Cold Tap Cold

- Utilizes an expedited wash cycle and time-saving continuous spray rinse to clean small lightly soiled loads in the fastest time possible.

7. Wet load of items. For items that need only to be rinsed, use this cycle with 2nd Rinse option (on some models). -- Drain & Spin

- Utilizes a high speed spin to extract water from wet items. For items that need to be rinsed, select the 2nd Rinse option (on some models) when using this cycle.

B. Deep Rinse: Set this option when adding fabric softener to the washer

C. Status lights: The Status lights show the stage the washer is in. When the selector knob is set to a new cycle, the Status lights will flash momentarily, showing the stages the cycle will go through.

#### Status light

- On: When the fabric softener option has been selected.
- Wash: When the washer is in the wash portion of the cycle.
- Rinse: When the washer is in the rinse portion of the cycle.
- Spin: When the washer is draining and/or spinning.
- Lid Locked: When the washer lid is locked. This feature prevents the lid from being opened while the washer is in the spin cycle or coasting to a stop.

NOTE: If the Status lights are blinking, the operation of the washer has been paused. To resume operation press the Start button (the lid must be closed).

D. Temperature

- Select the water temperature for the washer cycle (all rinses use cold water). Always follow fabric manufacturer's care label or instructions when laundering.
- Tap Cold\* uses incoming tap water, which can provide energy savings. For all other temperature selections, a mixture of hot and cold water is used to achieve the ideal temperature for each temperature setting. \*Please note that some detergents do not fully dissolve in very cold water. If you experience this, it is recommended you choose a setting other than Tap Cold.

E. Load Size (on some models)

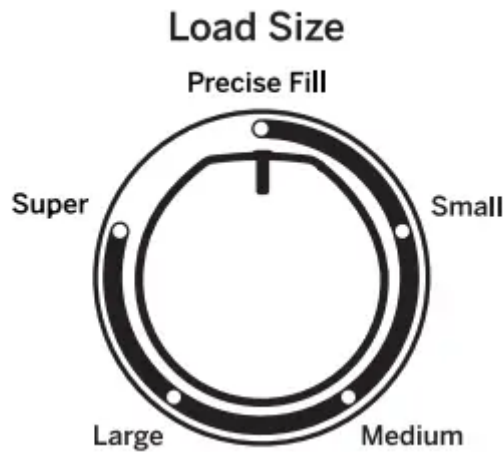

- Loosely load clothes no higher than the top row of holes in the washer basket.
- Precise Fill - This selection automatically provides the correct amount of water suited to the size and type of load placed in the unit.
- If you prefer to manually select the water level, select Small through Super. While Precise Fill is best for most loads and general washing, you may want to manually select the load size for specialty items such as bulky, lightweight comforters or pillows, where you want to ensure a larger water level is applied. Manual load size selections should be made for wet items placed in the washer, such as soaked towels or garments.

#### F. Options (on some models)

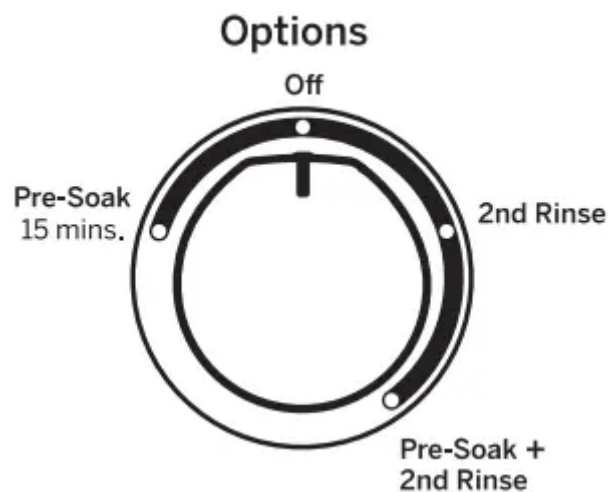

- Pre-Soak 15 mins. - This option begins with a brief agitation, soaks for this specified period of time, then moves through the rest of the cycle automatically.
- 2nd Rinse - When you use extra detergent or bleach to clean heavily soiled clothes, use the 2nd Rinse option to better remove additional residues. Pre-Soak + 2nd Rinse - Turns both options on.
- Off - Turns these options off.

## G. Start

- Press Start to begin the cycle. With the lid closed pressing Start again will pause the cycle and Status lights will blink. To continue the cycle, close the lid and press Start again. The water fill will continue with the lid opened, except when Precise Fill (on some models) is selected as the load size. The lid must be closed to continue filling when Precise Fill (on some models) is selected.
- If the lid is opened during the cycle, the cycle will pause and the Status lights will blink. To resume the cycle, close the lid and press Start.
- If the machine is paused for more than 24 hours, the cycle will be cancelled. To stop the cycle, turn the Cycle Selector to the Off position. NOTE: Machine will automatically cancel and drain when water is present and the lid is left open for 15 minutes or the unit is left in a paused state for 24 hours with the lid closed. Select cycle and press Start to begin new cycle.

## Consumer Help Indicator

Your washer is equipped with Consumer Help Indicator (CHI). CHI is our way to communicate a simple remedy for some situations that you can perform without the need to call for service. The chart below describes the helpful lights you may notice flashing on the display.

- Spin and Rinse lights blinking: If an out-of-balance condition is detected by the washer, the Spin and Rinse lights will blink during the remaining portion of the cycle and will stay illuminated for a short time after cycle completion. When this occurs, the washer is taking actions to correct the out-of-balance condition and complete the cycle normally. In some cases, the washer may not be able to balance the load and spin up to full speed. If you notice the load is more wet than normal at the end of the cycle, redistribute the load evenly in the wash basket and run a Drain & Spin cycle.
- Wash and Rinse lights blinking (Water not entering washer): Check your house water supply. Did you forget to turn on one or both supply valves after installation or coming back from vacation? As soon as the lights start to flash, the washer will initiate a 4 minute lockout period. The washer controls won't respond/change during this time. After the 4 minutes, you can begin your cycle again. If you try to bypass the lock-out period by unplugging the washer, the 4 minute timer will start over again.
- Lid Locked light: Lid Locked light will flash if 3 cycles have been started without opening the lid. The washer will not start another cycle until the lid is opened. Try opening, then closing the lid and starting a new cycle. If the problem persists, call GE Appliances for service

## Fabric Softener Dispenser (on models with an agitator)

The fabric softener dispenser automatically releases liquid fabric softener at the proper time during the cycle.

Do not stop the washer during the first spin. This will cause the dispenser to empty too soon.

To use, follow these steps:

1. Make sure dispenser is securely attached to agitator.
2. Use only diluted liquid fabric softener. Pour into dispenser, using amount recommended



on package.

Never pour fabric softener directly on clothes. It may stain them. NOTE: Do not pour bleach into FABRIC SOFTENER dispenser.

Never pour fabric softener

3. Add water to dispenser until it reaches the maximum fill line.



Do not pour anything into the agitator if the dispenser is removed.

4. Select Deep Rinse button on control panel for proper dispersion of the fabric softener.



**Deep Rinse**  
Select when using  
Fabric Softener

## Fabric Softener (on models with an infusor)

1.



Select Deep Rinse button on control panel.

2. Add diluted liquid fabric softener during the rinse cycle or use a fabric softener ball.

## Liquid Bleach Funnel

The water fill dilutes liquid chlorine bleach as the washer fills for the washer cycle.

1. Check clothing care labels for special instructions.
2. Measure liquid bleach carefully, following instructions on the bottle. Never pour undiluted liquid chlorine bleach directly onto clothes or into the wash basket. Do not pour powdered bleach into bleach funnel.
3. Before starting the washer, pour measured amount of bleach directly into bleach funnel. Avoid splashing or over-filling dispenser. If you prefer to use powdered bleach, add it into the wash basket with your detergent.



Do not mix chlorine bleach with an oxi pre-treatment, ammonia or acids such as vinegar and/or rust remover. Mixing can produce a toxic gas which may cause death.

NOTE: Do not pour bleach into FABRIC SOFTENER dispenser.

Always follow fabric manufacturer's care label when laundering.

## Sorting Wash Loads

Sort by color (whites, lights, colors), soil level, fabric type (sturdy cottons, easy care, delicates) and whether the fabric produces lint (terry cloth, chenille) or collects lint (velveteen, corduroy). Wash

lint producers such as cotton towels and socks separate from lint collectors including synthetic garments and dress pants.

Fire Hazard: DO NOT wash fabrics soiled with flammable liquids or cleaning solvents. No washer can completely remove oil. DO NOT wash or dry anything that has been soaked in or spotted with any type of oil (including cooking oils). DO NOT reach into the washer until all moving parts have stopped. Doing so can result in death, explosion, fire or amputation.

### Loading the Washer (on models with an agitator)

Load dry items loosely, no higher than the top row of holes in the washer basket. When loading wet items, make sure you set the load/water level high enough to allow the items to move freely. To add items after washer has started, press Start/Pause. Lift the lid and submerge additional items next to the agitator. Close the lid and press Start to resume.

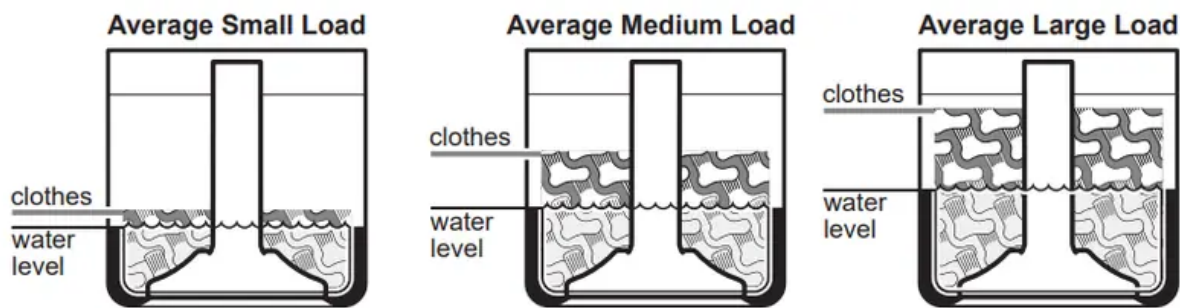

- Do not wrap long items like sheets or pants around the agitator.
- Do not wash fabrics containing flammable materials (waxes, cleaning fluids, etc.).
- Agitation will not start with the lid up.

### Loading the Washer (on models with an infusor)

Load dry items loosely in the washer basket. For best results, load items evenly and loosely around the outside of the basket, filling in towards the center on larger loads. To add items after washer has started, press Start/Pause. Lift the lid and submerge additional items around the outside of the basket. Close the lid and press Start to resume.



**Load clothes around outside  
of infusor - not over it.**

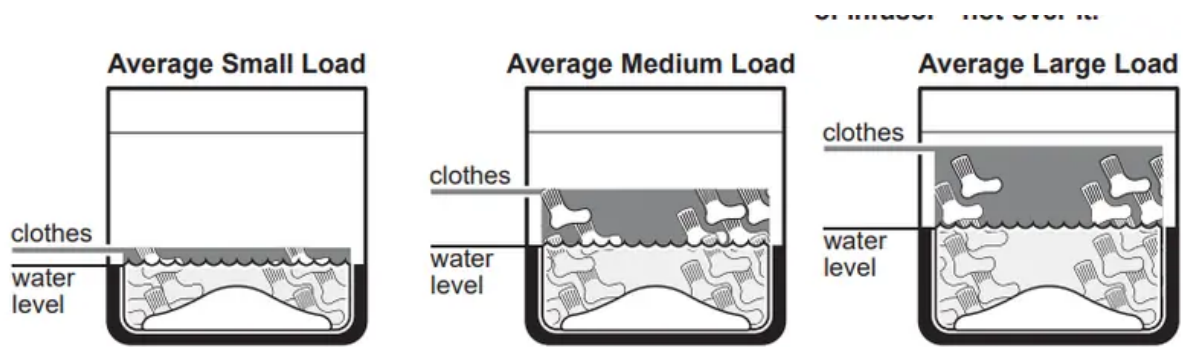

- Do not place large items such as sheets, blankets and towels across the Infusor. Load them around the outside of the basket.
- Do not wash fabrics containing flammable materials (waxes, cleaning fluids, etc.).
- Wash action will not start with the lid up.

### Proper Use of Detergent

- Using too little or too much detergent is a common cause of laundry problems.
- Use less detergent if you have soft water, a smaller load or a lightly soiled load.
- For spots, apply pre-treatment to items as recommended on the product label. Application should be made in the basket to prevent overspray which may cause the coloring on the lid or graphics to fade.
- Place detergent packets in the bottom of the wash basket before adding clothes.
- 



We recommend the use of High Efficiency detergents such as  in your energy efficient washer. HE detergents are formulated to work with low water wash and rinse systems. HE detergents reduce the oversudsing problems commonly associated with regular detergents.

- When using high efficiency or concentrated detergents, consult the product label to determine amount required for optimum performance. Excessive detergent will negatively impact wash performance.

### WiFi Connect (For customers in the United States only)

- Your laundry center's washer is GE Appliances WiFi Connect compatible using the optional GE Appliances ConnectPlus module.
- To connect this appliance to the internet you will need to purchase a GE Appliances ConnectPlus and attach the module to your appliance through the communication port in the appliance. The GE Appliances ConnectPlus will allow your appliance to communicate with your smartphone for remote appliance monitoring and notifications.

- Please visit web to learn more about connected appliance features and to learn what connected appliance app's will work with your smartphone.
- WiFi Connectivity: For assistance with the appliance or the ConnectPlus network connectivity, please call GE Appliances
- Visit your local authorized GE Appliances Parts distributor or order by phone during normal business hours.

Part Number: PBX10W00Y0 WiFi

Accessory: ConnectPlus module

## Care And Cleaning - Washer

### Exterior of the Washer

- Immediately wipe off any spills with a damp cloth.

### Interior of the Washer

- Leave the lid open after washing to allow moisture to evaporate. If you want to clean the basket, use a clean soft cloth dampened with liquid detergent; then rinse. (Do not use harsh or gritty cleaners.)

### Cleaning the Fabric Softener Dispenser (on some models)

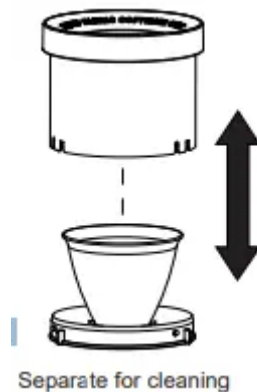

1. Remove the dispenser from the top of the agitator.
2. Separate the dispenser cup from the cover by grasping the top and pushing down on the inside of the cup with your fingers. Dispenser cup will pop free from the cover.
3. To clean the dispenser, soak both the dispenser cup and the dispenser cover in the following solution: 1 US gallon (3.8 liters) warm water; 1/4 cup (60 ml) heavy-duty liquid detergent; 1 cup (240 ml) bleach
4. If necessary, loosen buildup with a clean, soft cloth after soaking. Do not use a stiff brush; you may roughen the surface of the dispenser.
5. Rinse and reassemble dispenser. Place dispenser back on the agitator.

## Water Supply Hoses

- Hoses connecting washer to faucet should be replaced every 5 years.

## Moving and Storage

- Ask the service technician to remove water from drain pump and hoses. Do not store the washer where it will be exposed to the weather.

## Long Vacations

- Be sure water supply is shut off at faucets. Drain all water from hoses and water filter pump area if weather will be below freezing.

## Getting started - Dryer

### WARNING

- To reduce the risk of fire, electric shock, or injury to persons, read the IMPORTANT SAFETY INFORMATION before operating this appliance.
- Fire Hazard: Keep flammable materials and vapors, such as gasoline, away from dryer. DO NOT dry anything that has ever had anything flammable on it (even after washing). No washer can completely remove oil. DO NOT dry anything that has ever had any type of oil on it (including cooking oils). Items containing foam, rubber, or plastic must be dried on a clothesline. Failure to do so can result in death, explosion, or fire

Throughout this manual, features and appearance may vary from your model.

### For models without E-Dry:

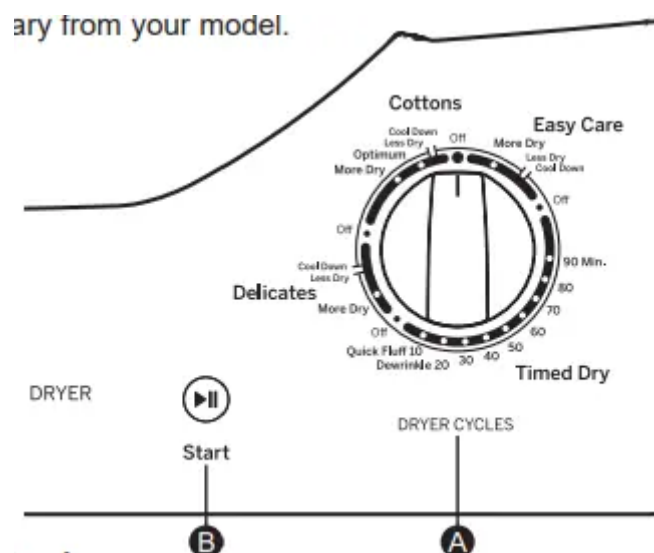

### Step 1

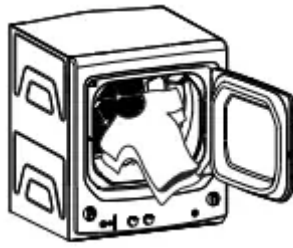

- Loosely add items.
- Close door.

NOTE: Dryer will not start with door open

Step 2



- Select a dry cycle.

Step 3



- Press the Start button.

IMPORTANT: Clean the lint filter each time you use the dryer.

NOTE: This appliance is designed so that the washer and dryer can be operated at the same time.

#### A. Dryer Cycles

- Cottons: For cottons and most linens. For most loads, select Optimum dry.
- Easy Care: For wrinkle-free, permanent press and delicate items, and knits.
- Delicates: For delicate items, special-care fabrics and knits.
- Timed Dry: Set the Cycle Selector at the desired drying time.
- 30 Min. (Damp Dry): For leaving items partially damp.
- Dewrinkle (20 Min.): For removing wrinkles from items that are clean and dry or that are very lightly damp.
- Quick Fluff (10 Min.): For freshening or fluffing up already dry clothing, fabrics, linens and pillows. Provides 10 minutes of no heat tumbling.

## Fabric Care/Temperature

- Cottons (High Heat): For regular to heavy cottons.
- Easy Care (Med Heat): For synthetics, blends, delicates and items labeled permanent press.
- Delicates (Low Heat) For delicates, synthetics and items labeled tumble dry low.
- Quick Fluff (No Heat): For fluffing items without heat. Use the Timed Dry cycle.

Automatic cycles determine fabric dryness and provide automatic sensed drying. The timer does not rotate during the cycle until the thermostats sense that the clothes are dry, then the timer rotates automatically to Off.

Select Less Dry if you want your clothes slightly damp at the end of the drying cycle.

Select More Dry if you want them to feel drier. Timed Dry cycle runs for a selected time.

## Timed Cycle

- Timed Dry: For manual drying

B. Start - Close the dryer door. Press Start. Opening the door during operation will stop the dryer. To restart the dryer, close the door and select Start to complete the cycle. A chime will sound at the end of the dry cycle.

For models with E-Dry:

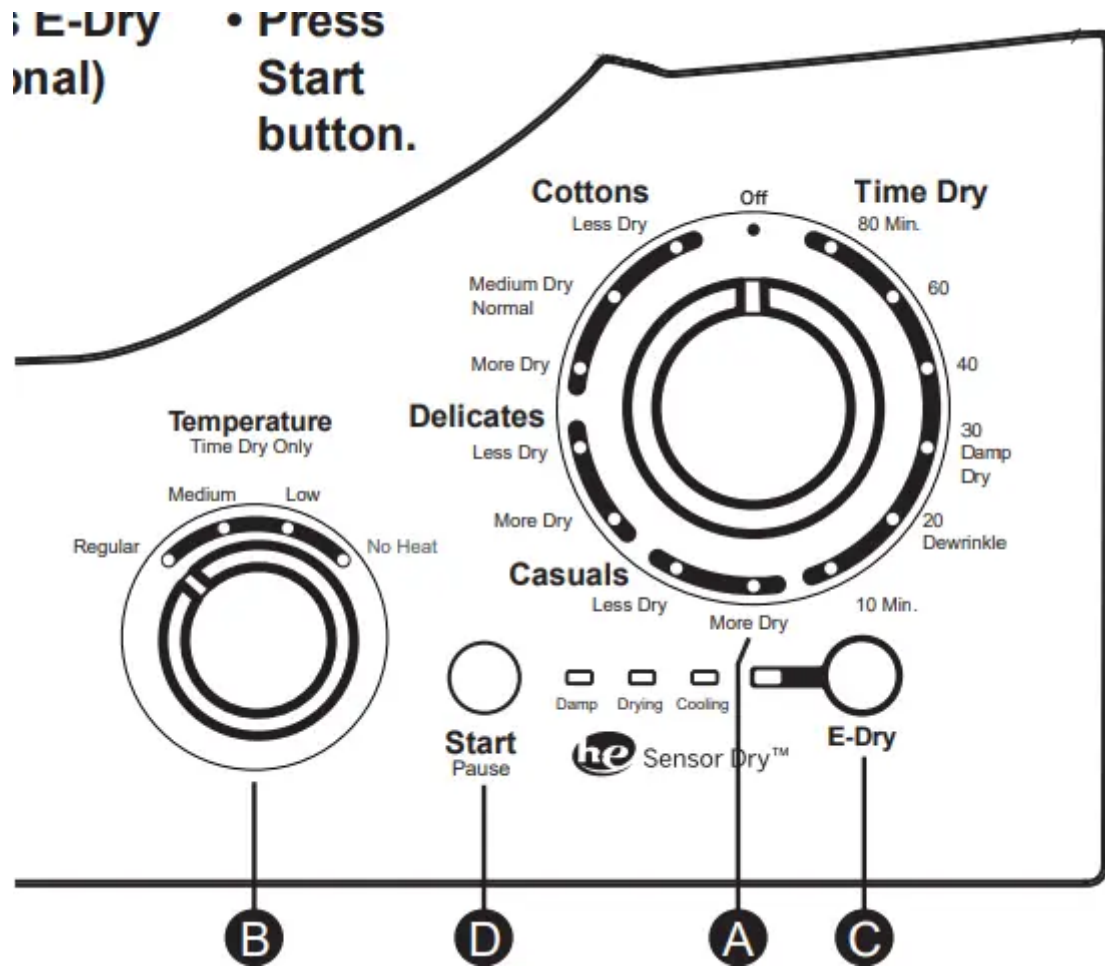

Step 1

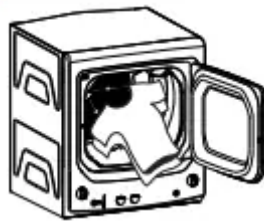

- Loosely add items.
- Close door

Step 2

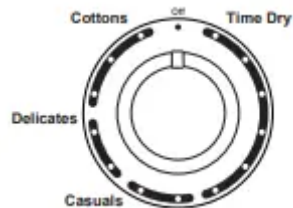

- Select a dry cycle

### Step 3



- Select Temperature if using Time Dry.

### Step 4



- Press E-Dry (optional)

### Step 5



- Press Start button

#### A. Dryer Cycles

- Cottons: For cottons and most linens. For most loads, select Medium Dry/Normal.
- Casuals: For wrinkle-free, permanent press and delicate items, and knits.
- Delicates: For delicate items, special-care fabrics and knits. Time Dry Set the Cycle Selector at the desired drying time.
- 30 Min. (Damp Dry): For leaving items partially damp.
- 20 Min. (Dewrinkle): For removing wrinkles from items that are clean and dry or that are very lightly damp.
- 10 Min. (Quick Fluff): For freshening or fluffing up already dry clothing, fabrics, linens and pillows. Provides 10 minutes of no heat tumbling

Automatic cycles determine fabric dryness and provide automatic sensed drying. The timer does not rotate during the cycle until the thermostats sense that the clothes are dry, then the timer rotates automatically to Off.

Select Less Dry if you want your clothes slightly damp at the end of the drying cycle.

Select More Dry if you want them to feel drier. Time Dry cycle runs for a selected time.

## Time Cycle

- Time Dry: For manual drying.

Use Time Dry with Temperature set to Medium to dry bulky items such as bedspreads and comforters.

### B. Temperature (Fabric Care) - For use with Time Dry settings only

- Regular (Cottons): For regular to heavy cottons.
- Medium (Casuals): For synthetics, blends, delicates and items labeled permanent press.
- Low (Delicates): For delicates, synthetics and items labeled tumble dry low.
- No Heat (Quick Fluff): For fluffing items without heat. Use the Timed Dry cycle.

Temperature is automatically set according to fabric type and is not adjustable: Regular heat = Cottons; Medium heat = Casuals; Low heat = Delicates.

### C. IE-Dry

- Reduces total energy consumption on automatic cycles by adjusting certain heat settings.
- The E-Dry selection can be used with Cottons only. NOTE: Cycle time will change when E-Dry is selected. Energy Star® models are tested on Cottons cycle with default settings to determine energy use rating of this dryer. The E-Dry option will default only for Cottons at Medium Dry/Normal and More Dry settings. Temperature settings on Regular are specifically designed for this cycle to reduce energy consumption. For optimal energy savings, turn E-Dry on. For optimal drying times, turn E-Dry off. Energy savings will vary across loads.

D. Start - Close the dryer door. Press Start. Opening the door during operation will stop the dryer. To restart the dryer, close the door and select Start to complete the cycle. A chime will sound at the end of the dry cycle.

## WiFi Connect (For customers in the United States only)

- Your laundry center's dryer is GE Appliances WiFi Connect compatible using the optional GE Appliances ConnectPlus module.
- To connect this appliance to the internet you will need to purchase a GE Appliances ConnectPlus and attach the module to your appliance through the communication port in the appliance. The GE Appliances ConnectPlus will allow your appliance to communicate with your smartphone for remote appliance monitoring and notifications.
- Please visit [web.t](#) to learn more about connected appliance features and to learn what connected appliance app's will work with your smartphone.
- WiFi Connectivity: For assistance with the appliance or the ConnectPlus network connectivity, please call GE Appliances.

- Visit your local authorized GE Appliances Parts distributor or order by phone during normal business hours.

Part Number: PBX10W00Y0

Accessory : WiFi ConnectPlus module

## Venting - Dryer

Venting the Dryer: For the best drying performance, the dryer needs to be properly vented. The dryer will use more energy and run longer if it is not vented to the specifications below. Carefully follow the details on Exhausting in the Installation Instructions.



### Fire Hazard

- This dryer **MUST** be exhausted to the outdoors.
- Use only 4" rigid metal ducting for the home exhaust duct.
- Use only 4" rigid metal or UL-listed dryer transition duct to connect the dryer to the home exhaust.
- **DO NOT** use a plastic vent.
- **DO NOT** exhaust into a chimney, kitchen exhaust, gas vent, wall, ceiling, attic, crawl space, or concealed space of a building.
- **DO NOT** install a screen in or over the exhaust duct.
- **DO NOT** install a booster fan in the exhaust duct.
- **DO NOT** use duct longer than specified in the exhaust length table. Failure to follow these instructions can result in death or fire

Ductwork that runs through an unheated area or that is near air conditioning should be insulated to reduce condensation and lint build-up.

## Care and Cleaning - Dryer

The Exterior: Wipe or dust any spills or washing compounds with a damp cloth. Dryer control panel and finishes may be damaged by some laundry pretreatment soil and stain remover products. Apply these products away from the dryer. The fabric may then be washed and dried normally. Damage to your dryer caused by these products is not covered by your warranty.

The Lint Filter: Clean the lint filter before each use. Slide out the grid that covers the filter. Run your fingers across the filter. A waxy buildup may form on the lint filter from using dryer-added fabric softener sheets. To remove this buildup, wash the lint screen in warm, soapy water. Dry thoroughly and replace. Do not operate the dryer without the lint filter and grid in place. Have a qualified technician vacuum the lint from the dryer once a year

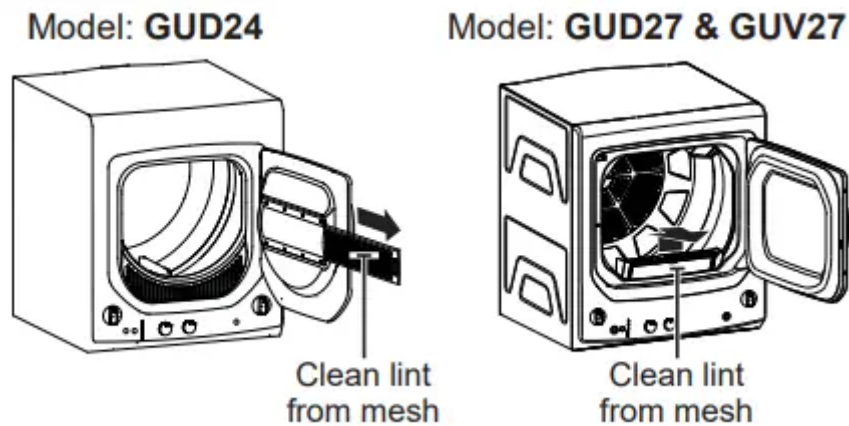

Dryer Interior and Duct: The interior of the appliance and exhaust duct should be cleaned once a year by qualified service personnel.

The Exhaust Duct: Inspect and clean the exhaust ducting at least once a year to prevent clogging. A partially clogged exhaust can lengthen the drying time. Follow these steps:

1. Turn off electrical supply by disconnecting the plug from the wall socket.
2. Disconnect the duct from the dryer.
3. Vacuum the duct with the hose attachment and reconnect the duct.

The Exhaust Hood: Check with a mirror that the inside flaps of the hood move freely when operating. Make sure that there is no wildlife (birds, insects, etc.) nesting inside the duct or hood

## Troubleshooting Tips - Washer

### Water

#### 1. Too many suds

- Too much detergent or soft water: Measure your detergent carefully. Use less soap if you have soft water, a smaller load or a lightly soiled load.

#### 2. Water leaks

- Using too much detergent: Use less detergent. Use less soap if you have soft water, a smaller load or a lightly soiled load.

- Fill hoses or drain hose is improperly connected: Make sure hose connections are tight at faucets and rubber washers are installed. Make sure end of drain hose is correctly inserted in and secured to drain facility.
- Household drain may be clogged: Check household plumbing. You may need to call a plumber.
- Constant water pressure to fill hoses at water source: Tighten hoses at the faucets and turn the water off after each use. Check condition of fill hoses; they should be replaced every 5 years.

### 3. Water temperature seems incorrect

- Cooler water temperatures provide improved energy efficiency: New laundry detergents have been formulated to work with cooler water temperatures without affecting wash performance.
- Water supply is turned off or improperly connected: Turn both hot and cold faucets fully on and make sure hoses are connected to correct faucets.
- Water valve screens are stopped up: Turn off the water source and remove the water connection hoses from the upper back of the washer. Use a brush or toothpick to clean the screens in the machine. Reconnect the hoses and turn the water back on.
- House water heater is not set properly: Make sure house water heater is delivering water at 120°F–140°F (48°C– 60°C).

### 4. Water pumped out before cycle is complete

- Water was left in unit for 24 hours with lid closed or 15 minutes with lid open: Previous cycle has been cancelled. Close lid, select new cycle, and start machine.

### 5. Water won't drain

- Drain hose is kinked or improperly connected: Straighten drain hose and make sure washer is not sitting on it. Top of drain outlet should be less than 8 ft (2.5 m) above floor.

### 6. Washer pauses during spin cycle

- This is normal: The washer may pause during the spin cycle to remove soapy water more efficiently.

### 7. Can hear but not see water at the end of the cycle

- This is normal: The pump leaves a little water in its intake and this is diluted with clean rinse water.

### 8. Water level seems low

- This is normal: Water may not cover the top level of the clothes.
- This is normal for this high efficiency washer.

## 9. Water levels lower than previous washer

- This is normal for a high efficiency washer with an infusor: A washer with an infusor is a high efficiency washing machine. This system requires less water while providing effective cleaning action. You may notice that the water level is lower than on your previous washer.

## 10. Water siphoning out of washer

- Drain standpipe is too low or hose too far into standpipe: The drain hose must exceed 30" height at some point between the washer back and the drain pipe. Use anti-siphon clip. See the Installation Instructions.

## Operation

### 1. Washer won't operate

- Washer is unplugged: Make sure cord is plugged securely into a working outlet.
- Water supply is turned off: Turn both hot and cold faucets fully on. Controls not set properly Check controls.
- Lid is open—safety feature prevents agitation and spinning when lid is up: Close lid and reset cycle, to the beginning if necessary.
- Circuit breaker/fuse is tripped/blown: Check house circuit breakers/fuses. Replace fuses or reset breaker. Washer should have separate outlet.
- Electronics need reset: Unplug washer, wait 2 minutes, plug back in and press Start.
- Start was not pressed: Press Start.

### 2. Movement inside machine when shut off

- Shifting mechanism is disengaging the motor: When the machine is manually turned off, the shifter will disengage the motor before completely shutting down. If lid is raised before the motor is disengaged, it will resume when lid is closed.

### 3. Short spray and delay after pushing the Start button

- Lid was opened and closed between cycle selection and start: This is normal. See START-UP SEQUENCE in the Safety Instructions section.

### 4. Washer spins and pauses at the beginning of cycles

- This is normal: The washer is sensing the load.

### 5. Washer pauses during wash cycle

- The Soak Option was chosen: This is normal. The washer alternates between agitate and soak during these cycles to get your clothes cleaner with less wear.
- This is normal: Many cycles incorporate as series of soaks within the agitation period to get your clothes clean with less wear.

## 6. Basket seems loose

- Basket moves or rotates freely: Washer basket does not have a traditional brake. Washer basket will move freely. This is normal.

## 7. Spin time longer than previous washer

- This is normal for a high efficiency washer with an infusor: A washer with an infusor is a high efficiency washing machine. Extra spin time typically reduces dryer time/energy usage (i.e. reduces total energy when using both a washer and a dryer). You may notice that the spin time is longer than on your previous washer.

## 8. Blinking Spin light or Spin light on at end of cycle

- Out of balance condition has been detected: Allow cycle to continue and finish. If load is wet at the end of the cycle, even out load and run a Drain & Spin cycle.

## Performance

### 1. Clothes too wet

- Incorrect spin cycle selected: Make sure the spin cycle selected matches the load you are washing. Some fabrics will feel wetter when rinsed with cold water.
- Wash load out of balance: Redistribute load in washer and run through Drain & Spin cycle.

### 2. Colored spots

- Incorrect use of fabric softener: Check fabric softener package for instructions and follow directions for using dispenser. Pretreat stain and rewash.
- Dye transfer : Sort whites or lightly colored items from dark colors

### 3. Grayed or yellowed clothes

- Detergent amount: Be sure to follow detergent manufacturer's directions.
- Hard water: Use a water conditioner like Calgon brand or install a water softener.
- Water is not hot enough: Make sure water heater is delivering water at 120°F–140°F (48°C– 60°C). Washer is overloaded Select load size to match clothes load.
- Dye transfer: Sort clothes by color. If fabric label states wash separately, unstable dyes may be indicated.

### 4. Lint or residue on clothes

- Clothes are air or line dried: If you do not dry your clothes with a clothes dryer, your clothes may retain more lint.
- Incorrect sorting: Separate lint producers from lint collectors.
- Washing too long: Wash small loads for a shorter time than larger loads

- Detergent not dissolving: Add detergent as wash basket fills with water, before you load clothes. Try a liquid detergent. Use warmer water temperature.
- Overloading: Load clothes no higher than the top row of holes in the washer basket.
- Incorrect use of fabric softener: Check fabric softener package for instructions and follow directions for using dispenser.

#### 5. Pilling

- Result of normal wear on poly-cotton blends and fuzzy fabrics: While this is not caused by the washer, you can slow the pilling process by washing garments inside out.

#### 6. Snags, holes, tears, rips or excessive wear

- Pins, snaps, hooks, sharp buttons, belt buckles, zippers and sharp objects left in pockets: Fasten snaps, hooks, buttons and zippers. Remove loose items like pins, objects in pockets and sharp buttons. Turn knits (which snag easily) inside out.
- Undiluted chlorine bleach: Check bleach package instructions for proper amount. Never add undiluted bleach to wash or allow clothes to come in contact with undiluted bleach.
- Chemicals like hair bleach or dye, permanent wave solution: Rinse items that may have chemicals on them before washing.

#### 7. Wrinkling

- Improper sorting: Avoid mixing heavy items (like work clothes) with light items (like blouses). Try a fabric softener.
- Overloading or incorrect water level: Load your washer so clothes have enough room to move freely with water covering all of the clothes.
- Incorrect wash and dry cycles Match: Cycle selection to the type of fabric you are washing (especially for easy care loads).
- Repeated washing in water that is too hot: Wash in warm or cold water.

### Sounds

#### 1. “Metallic clicking”

- Shifter mechanism is engaging or disengaging: The drive system will engage at the start of agitate and disengage when agitate is complete. This occurs multiple times during the wash.

#### 2. Back and forth “swoosh” or light “clicking” sound during agitate

- Electric motor reversing direction: This sound is the motor rotating back and forth to agitate your laundry. Quick short agitation sounds Clothing redistribution At different periods of the agitation phase, the motor makes short agitation strokes to redistribute the load.

### 3. "Click" when water stops filling

- Relay switch: The relay makes a click sound when activated. The water level activates the relay and stops filling.

### 4. "Clicking" behind control panel during fill Automatic Temperature Control Valve This valve mixes in cold and hot water. The "clicking" is the valve turning on and off.

### 5. Water volume changes during fill

- Automatic Temperature Control Valve: This valve mixes in cold and hot water. The sound changes when the valves are turned on and off.

### 6. Motor "whinding up" or "coasting down" in spin

- Motor ramping up/down during spin cycle: The motor will speed up incrementally during the spin cycle. When spin is complete, it will coast until it stops.

### 7. "Humming"

- Water drain pump: The drain pump will make a humming sound when pumping out water after agitation stops and continue until spin is complete.

### 8. "Gurgling"

- Water drain pump: When the pump starts drawing in air, It starts to gurgle. The washer should then begin spinning and the sound will continue until it is done spinning.

## Problem

### 1. Dryer doesn't start

- Dryer is unplugged: Make sure the dryer plug is pushed completely into the outlet. Fuse is blown/circuit breaker is tripped Check the house fuse/circuit breaker box and replace fuse or reset breaker. Note: Most electric dryers use 2 fuses/ breakers.

### 2. Dryer doesn't heat

- Fuse is blown/circuit breaker is tripped; the dryer may tumble but not heat: Check the house fuse/circuit breaker box and replace both fuses or reset both breakers. Your dryer may tumble if only one fuse is blown or one breaker tripped.
- Gas service is off: Make sure gas shutoff at dryer and main shutoff are fully open.

### 3. Dryer shakes or makes noise

- Some shaking/noise is normal. Dryer may be sitting unevenly: Move dryer to an even floor space, or adjust leveling legs as necessary until even.

### 4. Greasy spots on clothes

- Improper use of fabric softener: Follow directions on fabric softener package.

- Drying dirty items with clean ones: Use your dryer to dry only clean items. Dirty items can stain clean items and the dryer.
- Clothes were not completely clean: Sometimes stains which cannot be seen when the clothes are wet appear after drying. Use proper washing procedures before drying.

#### 5. Lint on clothes

- Lint filter is full: Clean lint screen before each load. Improper sorting Sort lint producers (like chenille) from lint collectors (like corduroy).
- Static electricity can attract lint : See suggestions in this section under STATIC.
- Overloading: Separate large loads into smaller ones.
- Paper, tissue, etc. left in pockets: Empty all pockets before laundering clothes.

#### 6. Static occurs

- No fabric softener was used: Try a fabric softener. Bounce™ Fabric Conditioner Dryer Sheets have been approved for use in all GE Appliances dryers when used in accordance with the manufacturer's instructions.
- Overdrying: Try a fabric softener. Adjust setting to Less Dry.
- Synthetics, permanent press and blends can cause static: Try a fabric softener.

#### 7. Inconsistent drying times

- Type of heat: Automatic drying times will vary according to the type of heat used (electric, natural or LP gas), size of load, types of fabrics, wetness of clothes and condition of exhaust ducts.

## Dryer Problem

### 1. Clothes take too long to dry

- Improper sorting: Separate heavy items from lightweight items (generally, a well-sorted washer load is a well-sorted dryer load).
- Large loads of heavy fabrics (like beach towels): Large, heavy fabrics contain more moisture and take longer to dry. Separate large, heavy fabrics into smaller loads to speed drying time.
- Controls improperly set: Match control settings to the load you are drying.
- Lint filter is full: Clean lint filter before every load.
- Improper or obstructed ducting: Check installation instructions for proper ducting/venting. Make sure ducting is clean, free of kinks and unobstructed. Check to see if outside wall damper operates easily. Check the Installation Instructions to make sure the dryer venting is correct.

- Blown fuses or tripped circuit breaker: Replace fuses or reset circuit breakers. Since most dryers use 2 fuses/breakers, make sure both are operating.
- Overloading/combining loads: Do not put more than one washer load in the dryer at a time.
- Underloading: If you are drying only one or two items, add a few items to ensure proper tumbling.

## 2. Clothes are wrinkled

- Overdrying: Select a shorter drying time. Remove items while they still hold a slight amount of moisture. Select a Less Dry setting.
- Letting items sit in dryer after cycle ends: Remove items when cycle ends and fold or hang immediately.
- Overloading: Separate large loads into smaller ones.

## 3. Clothes shrink

- Some fabrics will naturally shrink when washed. Others can be safely washed, but will shrink in the dryer
  - To avoid shrinkage, follow garment care labels exactly.
  - Some items may be pressed back into shape after drying
  - If you are concerned about shrinkage in a particular item, do not machine wash or tumble dry it.

### **Warning**

This content is compiled from multiple sources and is provided for reference purposes only. It may not be complete or fully applicable to all situations. If you are unable to resolve your issue, please contact the product manufacturer or an authorized service provider for official support.