



Essential safety information

This appliance can be used by children aged from 8 years and above or elder people or induction ability or lack of experience and knowledge if they have been given supervision or instruction concerning use of the appliance in a safe way and understand the hazards involved. Children shall not play with the appliance. Cleaning and user maintenance shall not be made by children without supervision

The robot must be used in accordance with the directions in this Instruction Manual. GOOVI cannot be held liable or responsible for any damages or injuries caused by improper use.

To reduce the risk of injury or damage, keep these safety precautions in mind when setting up, using and maintaining your robot:

- Read all safety and operating instructions before operating your robot.
- Retain the safety and operating instructions for future reference.
- Heed all warnings on your robot, battery, charging Dock and in the owner's manual.
- Follow all operating and use instructions.



 symbol on the product or The indication on package:

Do not dispose of electrical appliances as unsorted municipal waste, use separate collection facilities.

Contact your local authority for information regarding the collection systems available. If electrical appliances are disposed of in landfills or dumps hazardous substances can leak into the groundwater and get into the food Chain, damaging your health and well-being. Please contact your local or regional waste authority for more information on collection, reuse and recycling programs.

Product Diagram

1.1 Robot

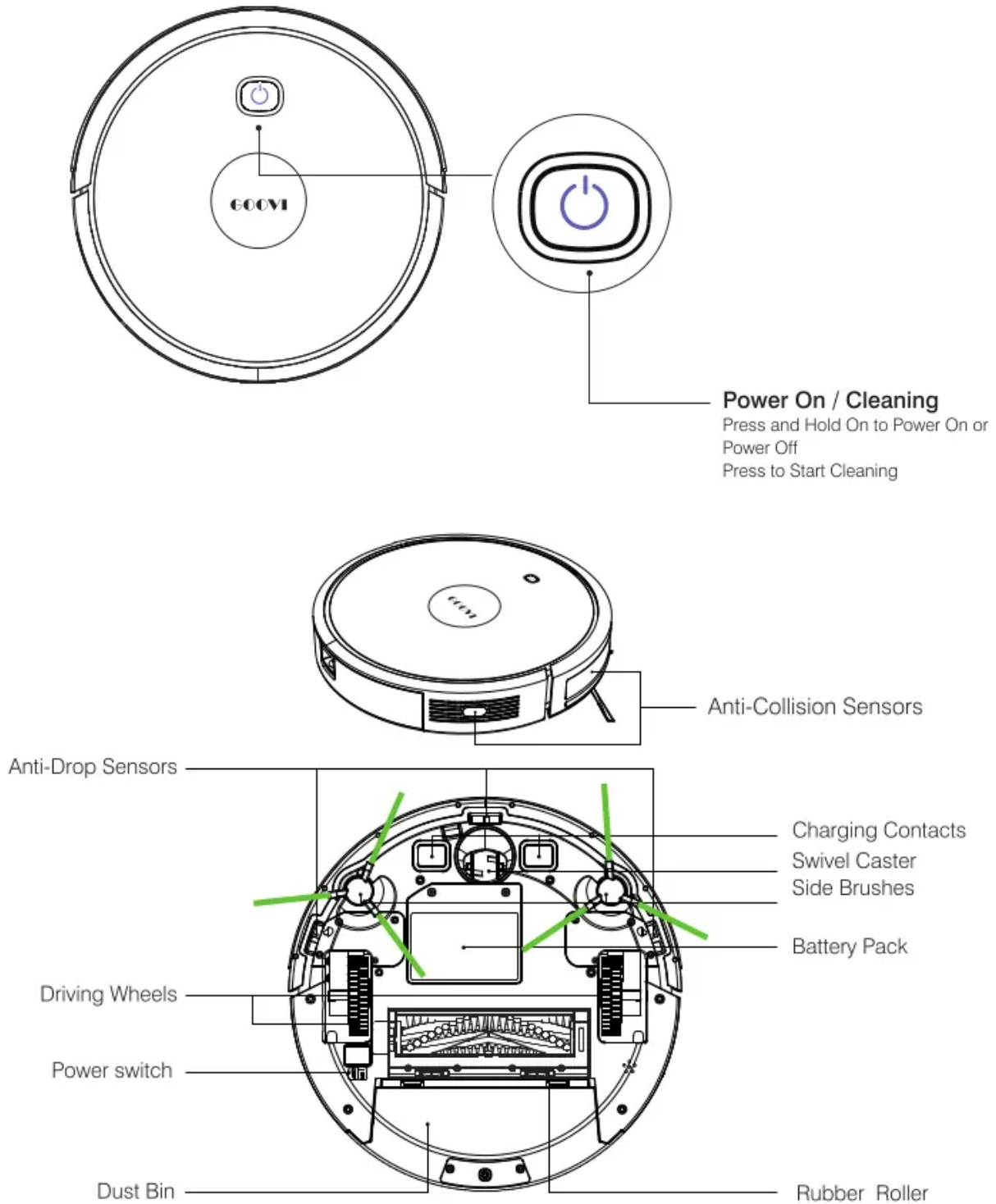

1.2 Accessories



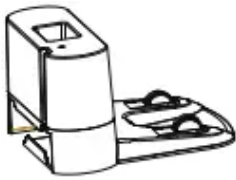

Charging Dock

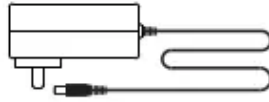

Adapter

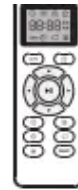

Remote Control



Sponge Filter and HEPA



Brush



4 x Side Brushes



Planting Brush



Battery (remote control)

1.3 Charging Dock

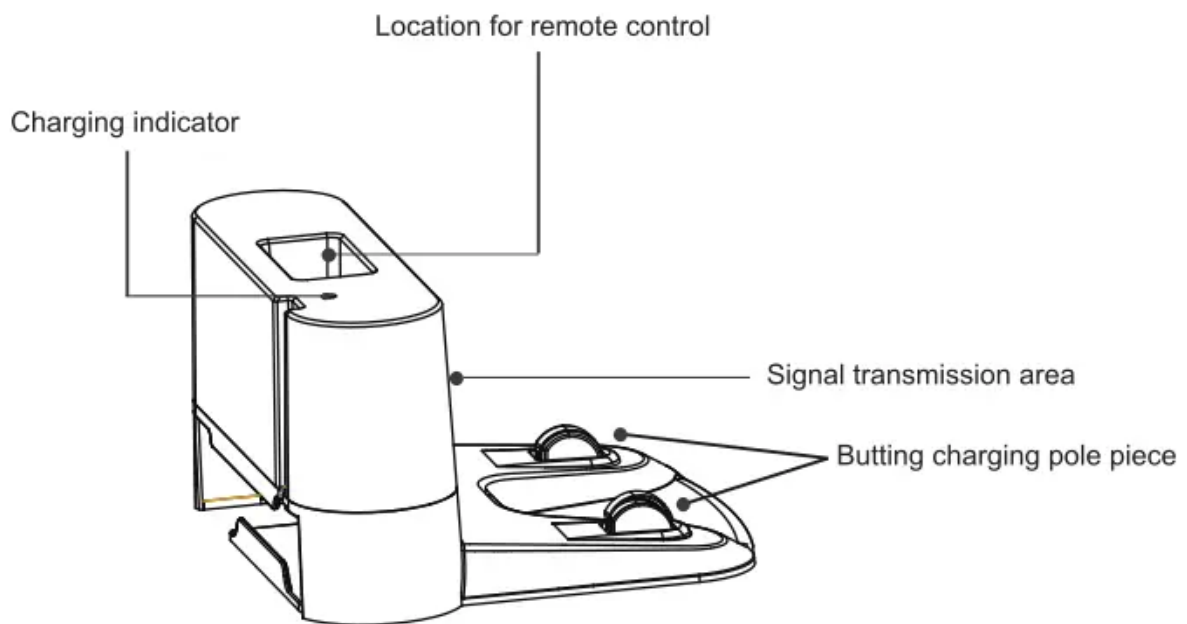

1.4 Remote Control



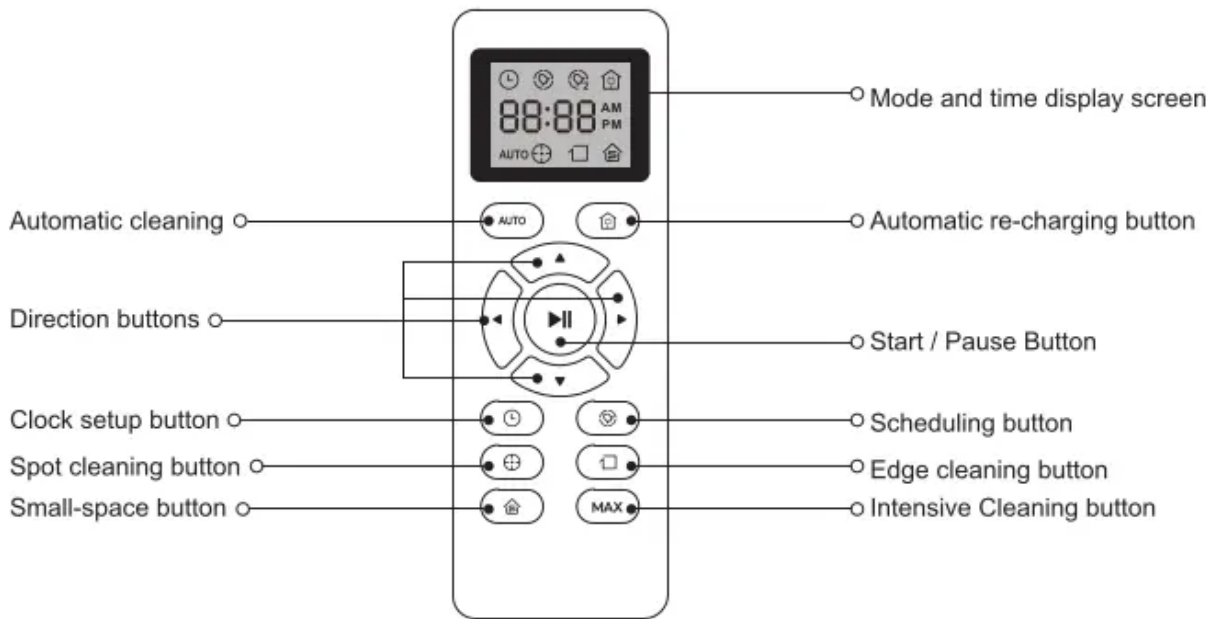

Operating and Programming

2.1 Notes Before Cleaning

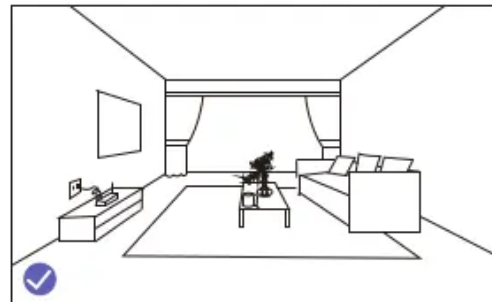
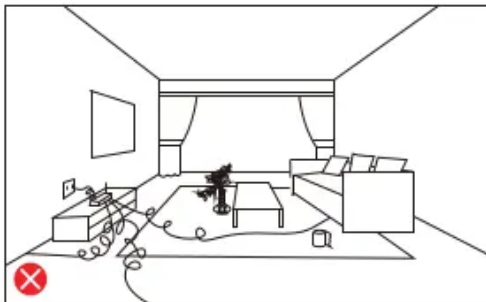

Before using Robot, pick up objects like clothing, loose papers, pull cords for blinds or curtains, power cords, and any fragile objects, if the Robot passes over a power cord and drags it, there is a chance an object could be pulled off a table or shelf.

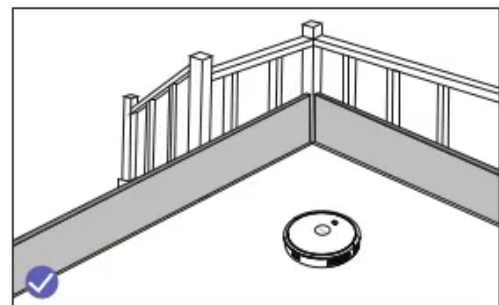
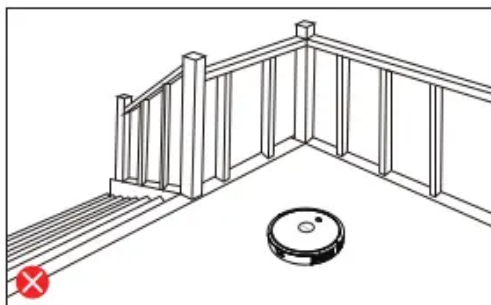

If the room to be cleaned contains a balcony, a physical barrier should be used to prevent access to the balcony and ensure safe operation

2.2 Quick Start

Plug in the Charging Dock. and take the rest wire into the trunking at The bottom of Charging Dock.

Note Dict put the rest wire into the trunking may stuck the Robot while Charging or Cleaning

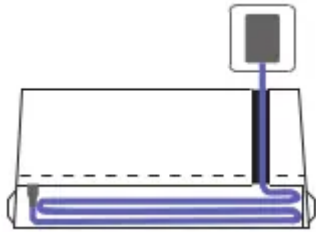

Charging Dock Position

Place the charging Dock again the wall& make sure the place is open uncluttered area leaving at least

+ 2 meters (6.5 feet) in front of the charging Dock

+ 1 meters (23 feet) on both sides of the charging dock.

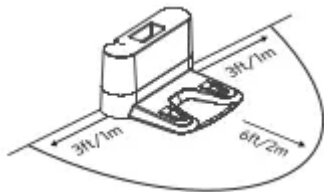

Install Side Brushes

Attach side brushes to the bottom of By pressing a brush into each slot with the matching color until it click.

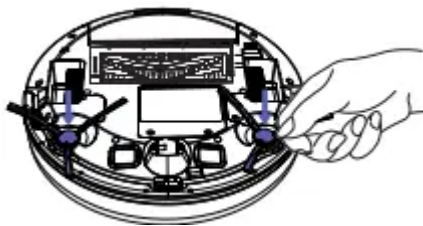

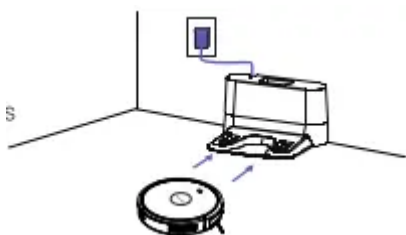

Activate the Robot

Place onto the Charging Dock, making sure the metal charging contacts on the charging Dock match up with those underneath the robot, if successful you will hear a series of tones, once the  Power button iluminates is ready for use.



Start Cleaning Cycle

- + Press  the power button Once to wake up the robot.
- + Press  the power button again to start a cleaning cycle (or press the button on Remote control)



If its battery gets low before finishing a cleaning cycle, robot Returns to the Charging Dock to recharge.

If the Charging Dock is inaccessible. Robot will not be able to recharge please place the robot manually on.

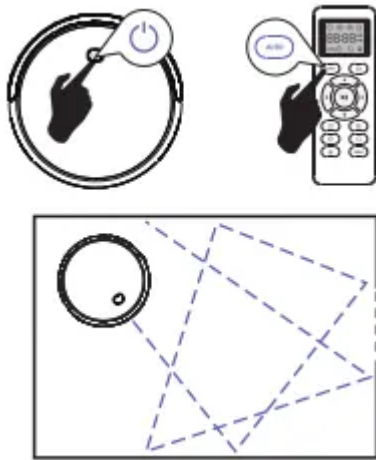
Charging Dock for charging. (Refer Activate the Robot)



Pause

- + To pause the robot during a cleaning cycle press the  button or press the button on Remote control.
- + To resume the cleaning cycle, press  button again
- + To send robot back to The Charging Dock. press button.

Note: The actions listed above can also be managed from the Remote control

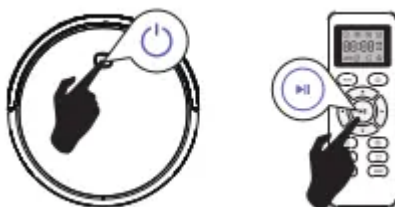

Power OFF

- + To end the clearing cycle and put robot in standby mode. Press and hold  button unt robots indicators tum off



2.3 How Cleans your home

Robot is designed to intelligently navigate and clean an entire level of your home a multifunctional function robot with cleaning Sweeping, Vacuuming, Wet/Dry mopping for your home

Auto Cleaning

- + At the start of a cleaning cycle, will map out your home and cleaning them efficiently
- + At various times throughout the cleaning cycle, touches up around the edges of the room. as well as chair legs and other furniture.
- + Once finishes its cleaning cycle. returns to the Charging Dock recharge.

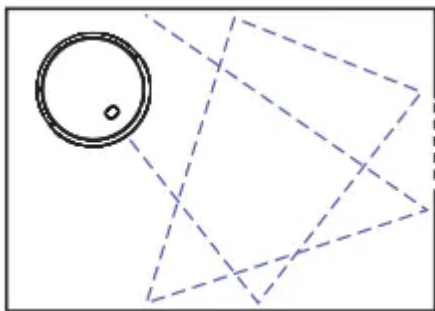
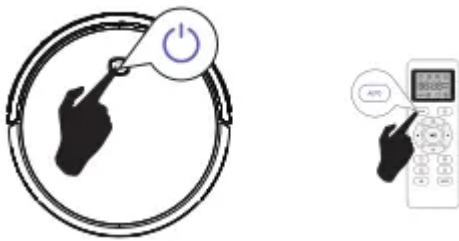

Spot Cleaning

When you select Spot Cleaning. robot intensely cleans a localized area by spiraling outward about 3 feet(1 meter) in diameter and then spiraling inward to where it started. When Spot Cleaning. Robot boosts its vacuum power to provide the best cleaning possible where you need it. To use Spot Cleaning. place robot on top of the localized debris and press (Spot) on the Remote control.

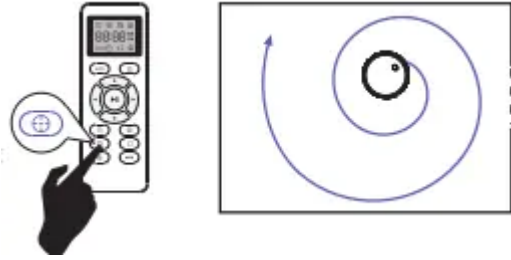

Max vacuuming Cleaning

Robot increases its vacuum power to provide a deeper clean when press the button on Remote control. Max Vacuuming Cleaning if Off by default

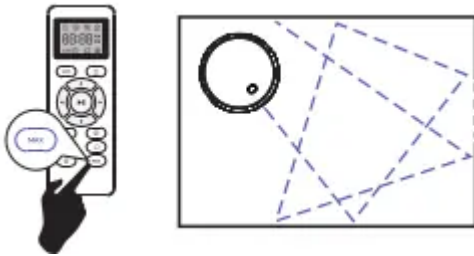

Edge Cleaning

After robot finishes cleaning the open areas of your floor. it uses Edge Clean to ensure that it has cleaned along walls and around furniture Legs. If you prefer a quicker edge cleaning. press the button on Remote Control.

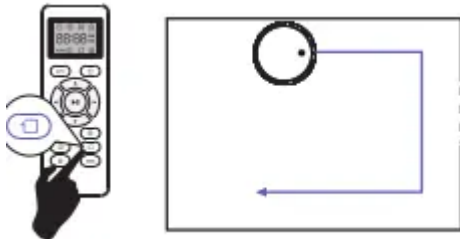



2.4 Cleaning Schedule

Robot has cleaning schedule settings which allow you to customize when Robot cleans your home. These settings are available only through the Remote Control



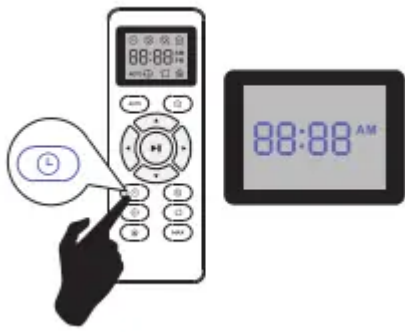

Note: Please make sure the Remote Control near by the Robot while sting the Clock or Schedule

Set the Remote Control's Clock

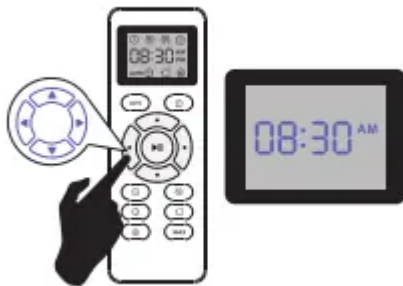

Press  button on Remote Control. and then the hour section begins to flash in the clock display setting window.



Press  or  button to select the desired figures. Press the  or  button to select the minute or hour section







And then press the  button. the Robot "BEEP" when the clock setting completed.

Setting Cleaning Schedule



Press  button on Remote Control. and then the hour section begins to Hash in the Cleaning Schedule display setting window.



Press  or  button to select the desired figures. Press the  or  button to select the minute or hour section



And then press the  button. the Robot "BEEP" when the Cleaning Schedule setting completed.

Cancel the Cleaning Schedule

Press and hold  button approximately 4 seconds on Remote Control. the Robot will "BEEP" when the Cleaning Schedule process cancel completed.



Regular Robot Care

To keep robot running at peak performance. perform the following care procedures, if you notice robot picking up less debris from your floor then empty the bin clean the filter and clean the extractors

3.1 Emptying Robot 's Bin

1. Press bin release button to remove bin



2. Open bin door to empty bin

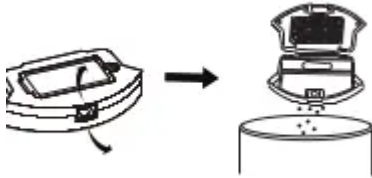

3.2 Cleaning Robot's Filter

1. Remove filter grasping the white tab

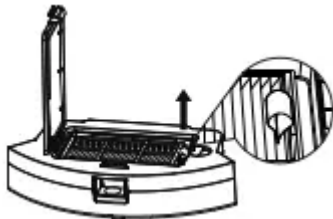

2. Shake off debris by tapping the filter against your trash container.



3.3 Cleaning Robot's Floor Tracking Sensor

Use a clean dry microfiber or soft cotton cloth to wipe any debris that has accumulated in the round sensor opening on the right side of the bottom surface. Do not spray cleaning solution directly into the sensor Opening.

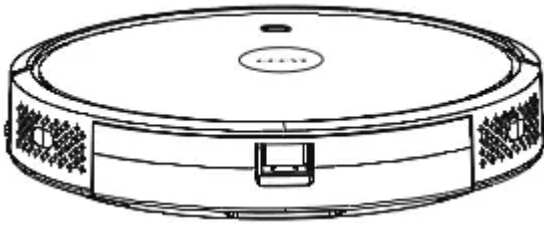

3.4 Cleaning Robot 's Extractors

1. Use a coin or small screwdriver to remove the screw. remove the extractor frame and obstructions.

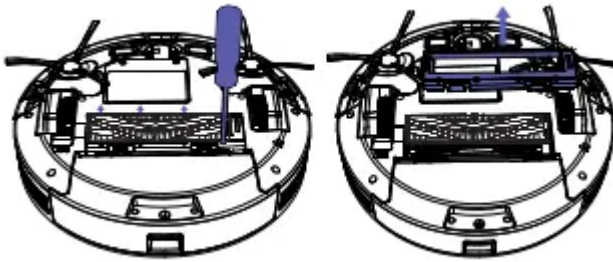

2. Remove the extractors. Remove any hair or debris that has collected underneath the caps and around the axles



3. Clear Robots Vacuum Path

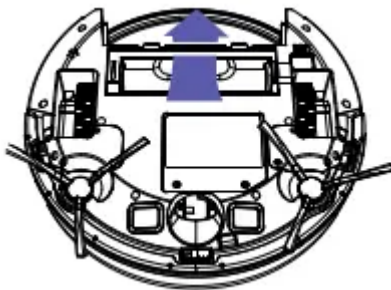

4. Reinstall the extractors. Match the color and shape of the extractor pegs with the color and shape of the extractor icons on the cleaning head module

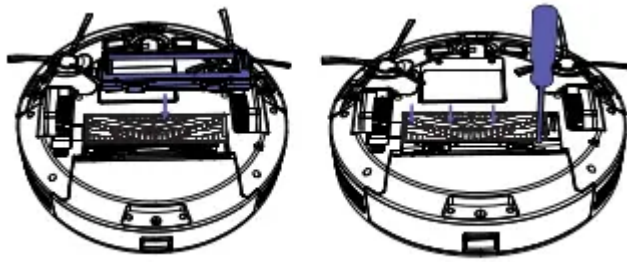

3.5 Battery and Charging / Information

Lithium Ion Battery

Important: Lithium ion batteries and products that contain lithium ion batteries are subject to stringent transportation regulations.

If you need to ship this product (with the battery included) for service travel or any other reason, you **MUST** comply with the following shipping instructions:

- + Remove the lithium ion battery from the product
- + Place a piece of tape over the battery's metal charging contacts
- + Reinstall the battery (with the tape on it) in the product and secure the battery door
- + Package the product in its original packaging or in your own packaging that prevents any movement during transportation
- + Ship via ground transportation only (no air shipping)

Battery Charging

To extend battery life always keep robot charged on the home base when not use.

Battery Storage

When storing robot off of the Charging Dock, remove the battery first. Then store robot and the battery in a cool, dry place.

Battery Disposal

Contact your local waste management authority for battery recycling and disposal regulations in your area.

Battery Removal

Follow these instructions to remove and reinstall robot's battery:

Unscrew the two screws on the battery door, then remove the door and battery.

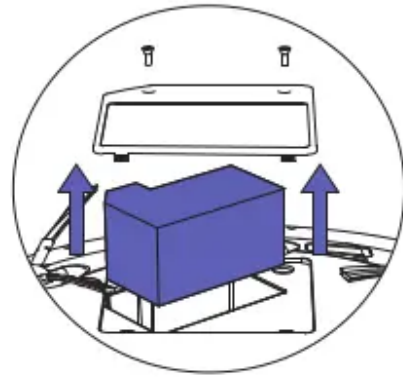
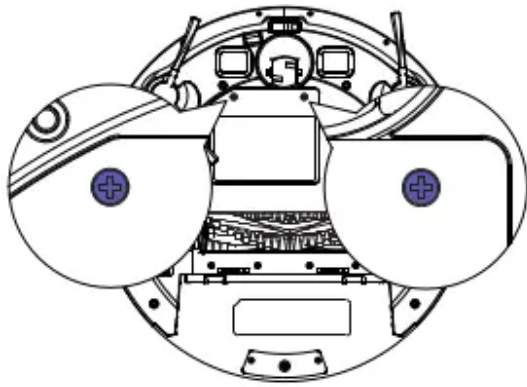

Reinstall the battery with the battery label and tabs facing up.

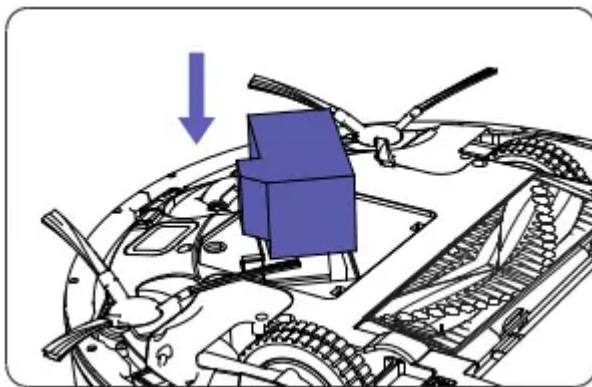

Reinstall the battery door and the two screws. Take care not to pinch the side brush in the battery door when re-installing the battery.

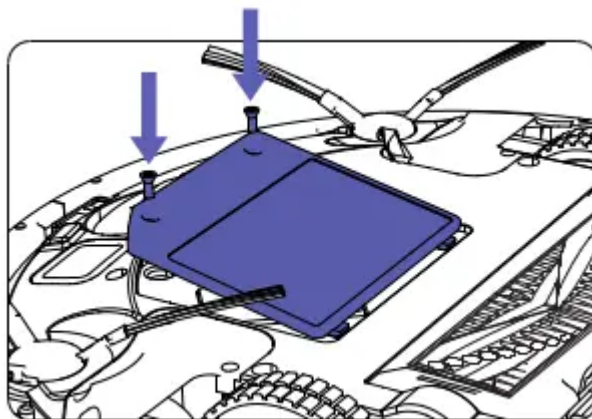

Troubleshooting

Robot will tell you something is wrong with a two-tone distress sound followed by a spoken message. The indicator will also blink or lit red. Refer to the chart as below to resolve Robots problem. If the e problem is not resolved, please contact our COST FREE customer service team for mo re assistance.

Rebooting Instructions

For some errors, rebooting Robot may resolve the problem. To reboot Robot, press the power button on the bottom on Robot, you will hear an audible tone signifying a successful reboot.

Robot signal		Likely Cause	What to Do
Red light solid	BEEP Once	Front caster wheel is stuck	Clean the front caster wheel and press the power button to restart the Robot.
	BEEP Twice	Robot's side brush may stuck	Clean the side brush and press the power button to restart the Robot
	BEEP Triple	Robot's vacuum fan is stuck or its filter is clogged.	Remove and empty Robot's bin. Clean Robot's fiiter. Then, briskly tap the bin to loosen any remaining trapped debris.
	BEEP Quartic	Robot's main extractors cant turn.	Remove and clean Robot's extractors and caps,
Red light flashing	BEEP Twice	Bumper is stuck.	Check whether the bumper is flexible
	BEEP Triple	Robot's cliff sensors are dirty.it is hanging over a drop, or it is stuck on a dark surface.	If Robot is hanging over a drop,or on a dark surface, start in a new location. Otherwise, wipe its cliff sensors with a dry cloth.
	BEEP Quartic	Robot cannot return to its Charging Dock or starting position,	Ensure there are no obstacles in front of the Charging Dock or starting position. Wipe the Charging contacts on both the Charging Dock and robot with a clean, dry cloth.

Specifications

Classification	Item	Specifications
Structural Class	Diameter	325mm
	Height	70mm
	Net Weight	2.6kg
Electronic Class	Voltage	14.4 V
	Battery Capacity	Lithium Battery 2600mAh
	Dustbin Volume	0.5L
	Charging Type	Automatic Charging
Cleaning Parameters	Cleaning Mode	Automatic Cleaning Spot Cleaning Edge Cleaning Appointment Cleaning
	Description of Light Display	Red Light: Failure warning
	One-time Charging Time	About 300 Minutes
	One-time Cleaning Time	About 100 Minutes
Host Button Type		Mechanical Button

Note: This product shall be stored in the ambient temperature range from -20°C to 60°C.

Warning

This content is compiled from multiple sources and is provided for reference purposes only. It may not be complete or fully applicable to all situations. If you are unable to resolve your issue, please contact the product manufacturer or an authorized service provider for official support.

Document generated by [ManualsFile](#)