

Installation

1. Turn Off Power to Heating/Cooling System

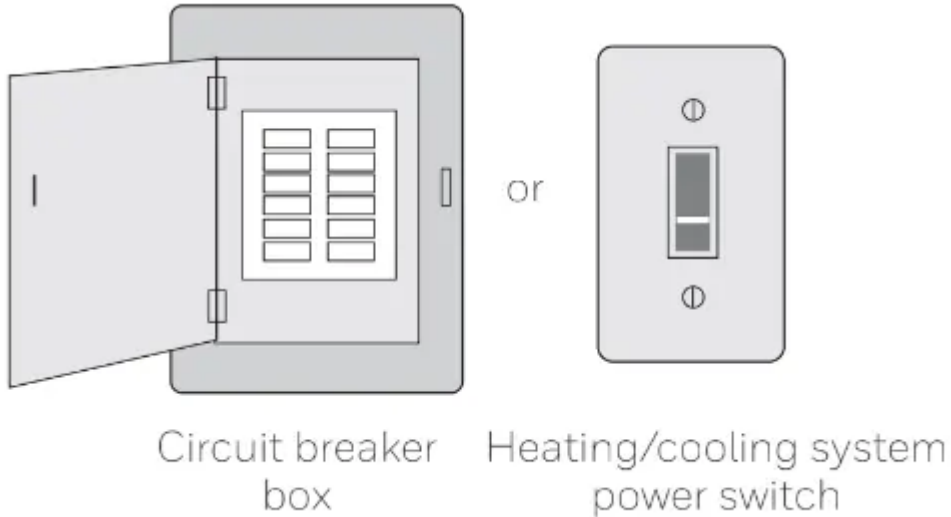

2. Remove Old Thermostat

Remove old thermostat but leave wallplate with wires attached.

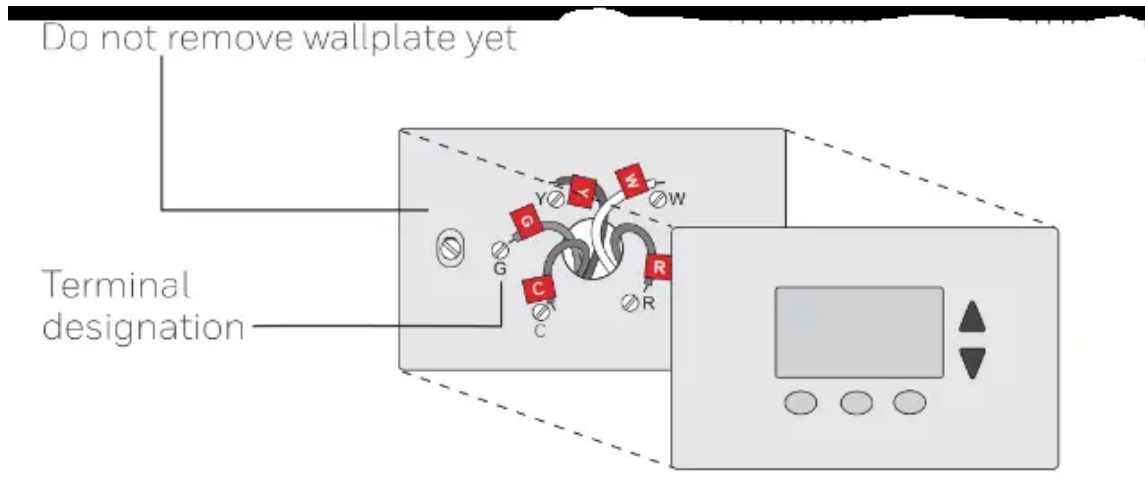

If you have an older thermostat with a sealed mercury tube, turn to page for proper disposal instructions.

3. Label Wires with Tags

Label the wires using the supplied wire labels as you disconnect them.



Wiring Labels		Étiquettes de fils		Rótulos para los cables					
Apply these wiring labels to each wire with the appropriate terminal designation as you remove it from the existing thermostat.		Lorsque vous retirez les fils des bornes du thermostat existant, collez ces étiquettes sur chaque fil correspondant à la lettre de la borne.		Coloque estos rótulos, con la designación de los terminales, en cada cable al remover los cables del termostato actual.					
B	B	Y2	Y2	C	C	E	E	F	F
G	G	H	H	L	L	O	O	P	P
R	R	RC	RC	RH	RH	T	T	U	U
V/VR	V/VR	W	W	W1	W1	W2	W2	W3	W3
X	X	X1	X1	X2	X2	Y	Y	Y1	Y1
AUX	AUX								

09-0823EFS-2 • 9-05 • Printed in U.S.A.

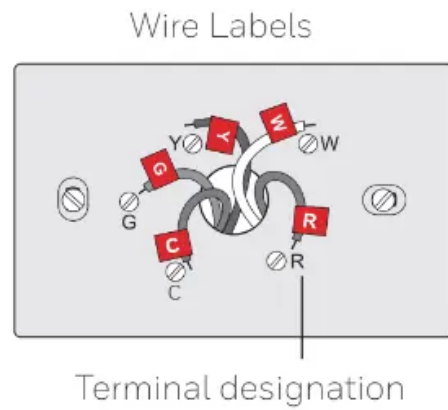

4. Separate Wallplate from New Thermostat

Remove wallplate from the new thermostat and mount onto wall.

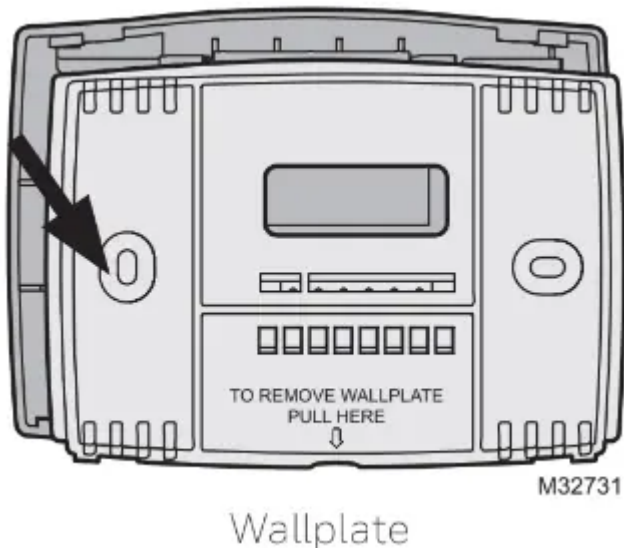

5. Mount Wallplate

Mount the new wallplate using the included screws and anchors.

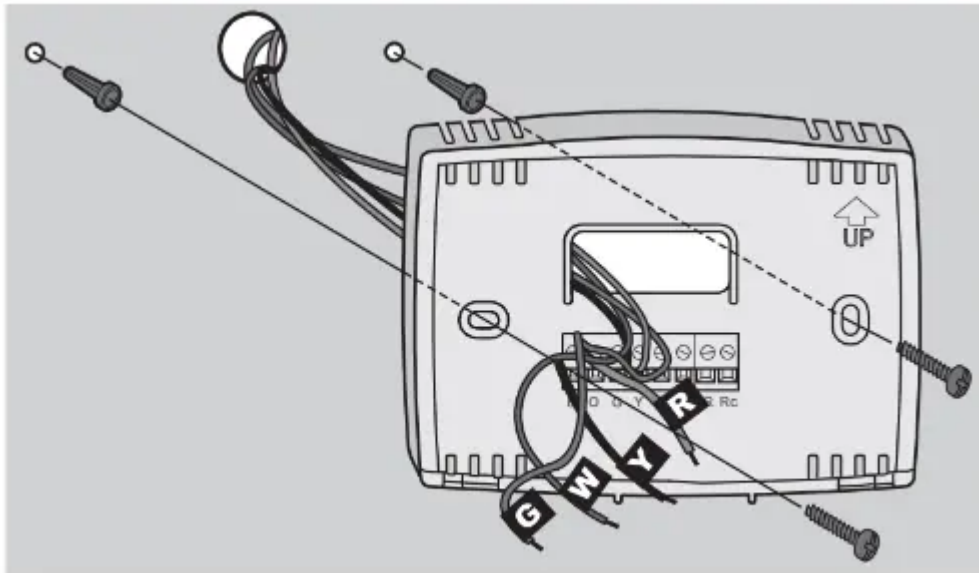

M32714

Drill 3/16-in. holes for drywall

Drill 3/32-in. holes for plaster

6. Connect Wires

Simply match wire labels.

If labels do not match letters on the thermostat, check “Alternate Wiring” on page 6 and connect to terminal as shown here (see notes, below).

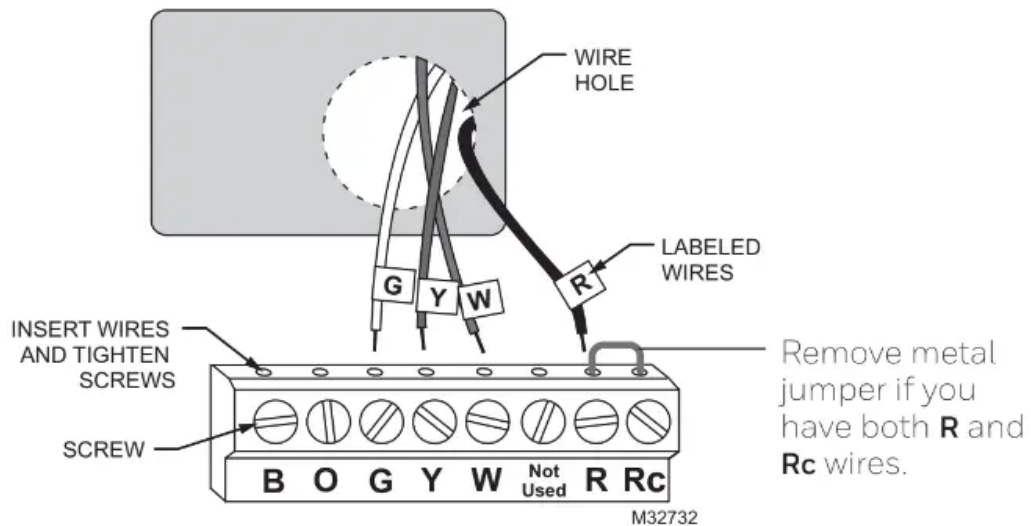

M32732

Thermostat does not work on Heat Pumps with auxiliary/backup heat.

We are here to help. Call 1-800-468-1502 for wiring assistance.

Alternate Wiring

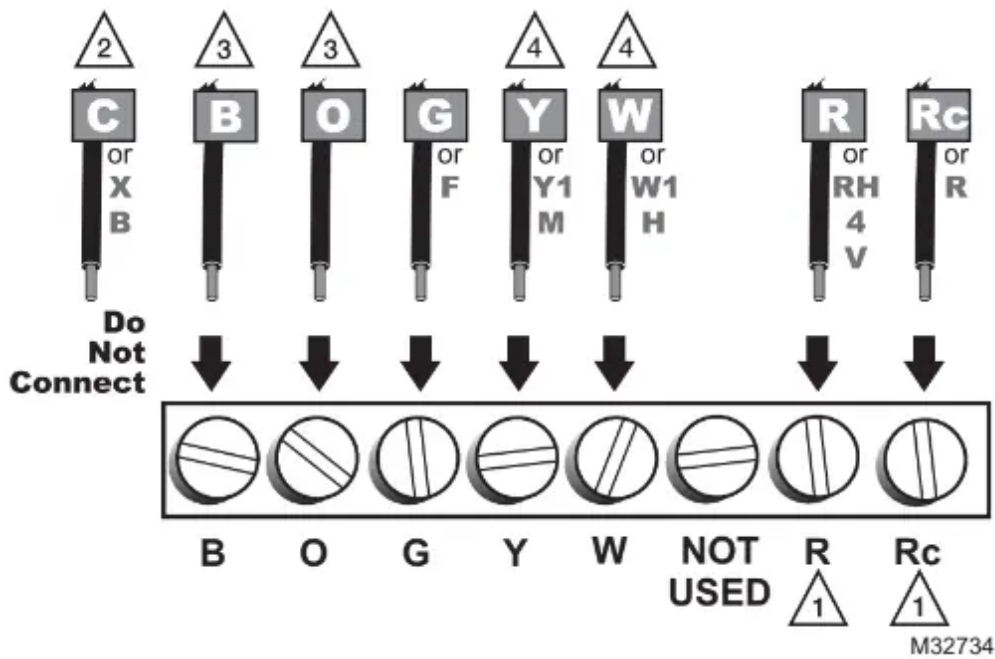

1. If wires will be connected to both **R** and **Rc** terminals, remove metal jumper.
2. Do not use **C** or **X**. Wrap bare end of wire with electrical tape.
3. If you have a heat pump without auxiliary/backup heat connect **O** or **B**, not both. If you do not have a heat pump, do not connect **B**. Wrap bare end of wire with electrical tape.
4. Place a jumper (piece of wire) between **Y** and **W** if you are using a heat pump without auxiliary/backup heat.

7. Install Batteries

Install two AAA alkaline batteries.

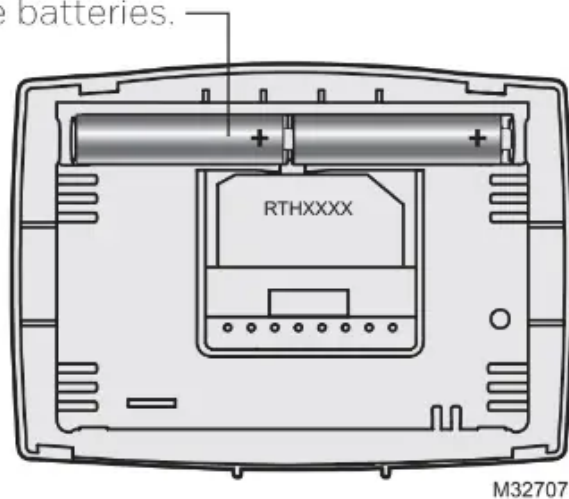

Back of thermostat

8. Set fan operation switch

Move the switch to the proper setting:

Gas or Oil: For gas or oil heating systems, leave the fan operation switch in this factory-set position (for systems that control the fan in a call for heat).

Electric or Heat Pump: Change the switch to this setting for heat pump or electric heat systems. (This setting is for systems that allow the thermostat to control the fan in a call for heat, if a fan wire is connected to the G terminal.)

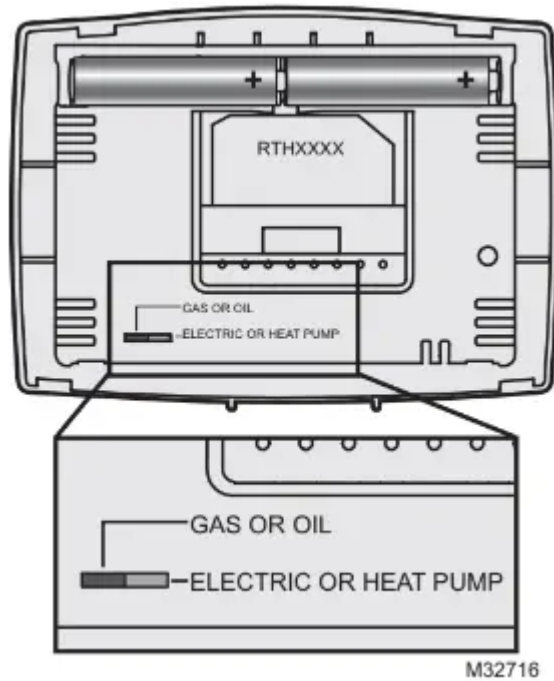

9. Install Thermostat onto Wallplate

Install thermostat onto the wallplate on the wall.

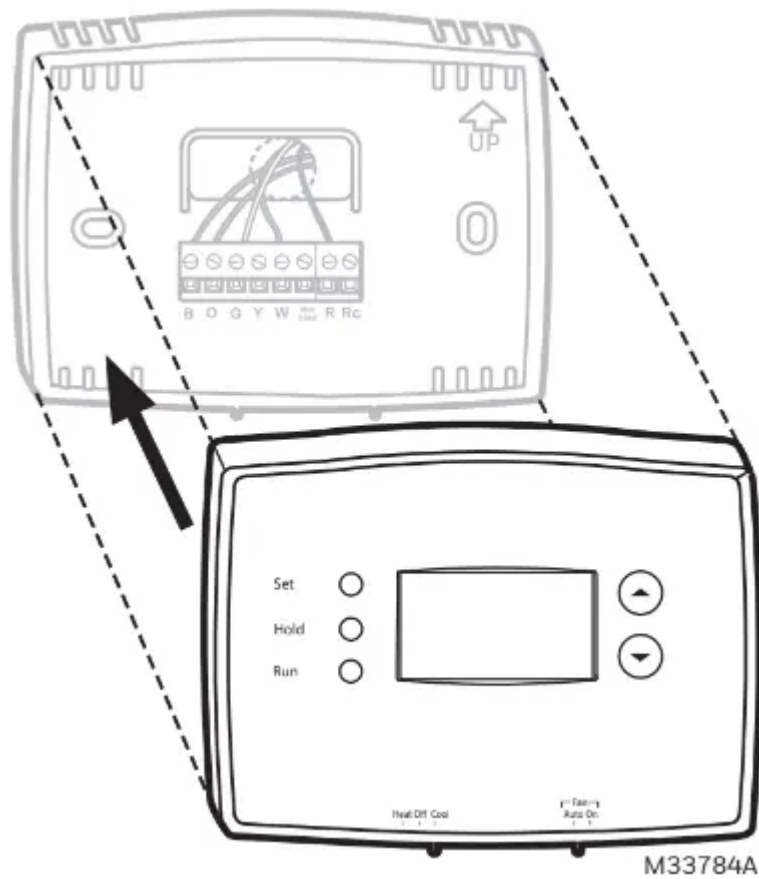

10. Turn Power Back On

Turn the power back on to the heating/cooling system.

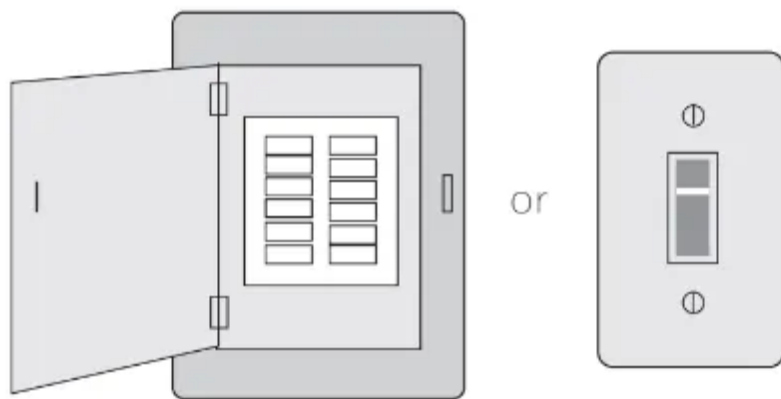

Circuit breaker box

Heating/cooling system power switch

11. If your system type is...

If your system type is:

- Single Stage Heat and Cool

- Heat Only or Cool Only

Congratulations, you're done!

If your system type is:

- Heat pump
- High efficiency furnace
- Hot water
- Electric furnace
- Gas/oil steam
- Gravity system

Continue with Advanced Installation to match your thermostat to your system type.

If you are not sure of your system type or if you have other questions, call us toll-free at 1-800-468-1502.

This thermostat works on 24 volt or 750 mV systems. It will NOT work on multi-stage conventional systems.

Advanced Installation

Enter System Setup

To enter system setup, press and hold both the ▲ and ▼ buttons until the display changes (approximately 5 seconds).

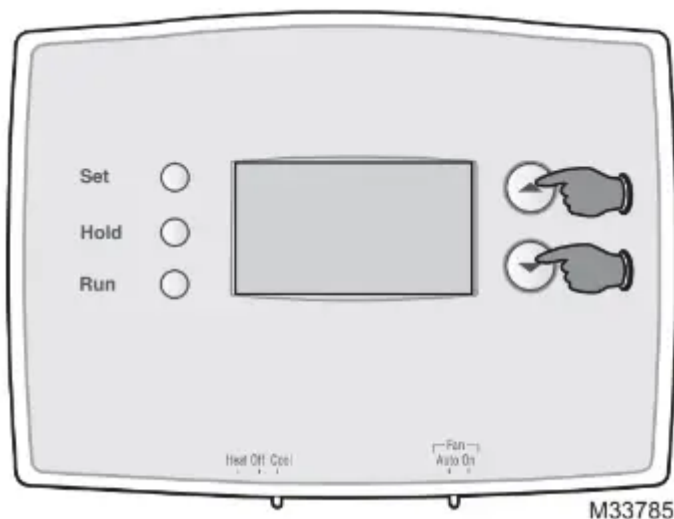

Changing Settings

1. Press the ▲ or ▼ button to change the setting.
2. Press the ▲ and ▼ buttons simultaneously for one second to advance to the next function.

3. Press the **RUN** button to exit and save settings.



NOTE: If you do not press any button for 60 seconds while you are in the setup menu, the thermostat automatically saves any changes made and exits the menu.

Function	Description Press the ▲ or ▼ button to	Setting
5	select your heating system and optimize its operation	5 Gas or oil furnace: Use this setting if you have a standard gas or oil furnace that is less than 90% efficient. 6 Electric furnace: Use this setting if you have any type of electric heating system. 3 Heat pump, hot water or high-efficiency furnace: Use this setting if you have a hot water system or a gas furnace of greater than 90% efficiency. 2 Gas/oil steam or gravity system: Use this setting if you have a steam or gravity heat system.
14	select Fahrenheit or Celsius temperature display	0 Fahrenheit temperature display (°F) 1 Celsius temperature display (°C)
15*	select Compressor Protection settings	1 On 0 Off
20	select clock display	0 12-hour display 1 24-hour display
21 (RTH2300 only)	select Change Filter Timer	0 Off 1 30 days 2 90 days 3 6 months 4 9 months 5 1 year
40 (RTH2300 only)	restore program schedule to default settings	0 Off 1 On: Program schedule default settings are listed on page 11.

About your new thermostat

Your new thermostat has been designed to give you many years of reliable service and easy-to-use, push-button climate control.

- Backlit display on RTH2300
- Displays ambient (measured) temperature at all times
- One-touch access to setpoint temperature
- Preset program settings

- Temporary and permanent override of schedule
- Built-in compressor protection

Thermostat controls

Set: Press to set time/day/schedule.

Hold: Press to override programmed temperature control.

Run: Press to resume program schedule.

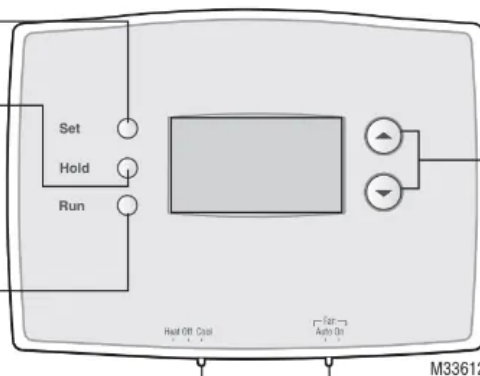

Temperature adjustment

Press the up or down buttons until you reach the desired temperature.

NOTE: Make sure the **SYSTEM** switch is set to the system you want to control (Heat or Cool).

System Switch is used to control your heating or cooling system.

- **Heat:** Heating system control.
- **Off:** All systems off.
- **Cool:** Cooling system control.

Fan Switch is used to control your fan.

In "Auto" mode, the fan runs only when the heating or cooling system is on.

If set to "On," the fan runs continuously.

Display screen

Setpoint indicator

Appears when the setpoint temperature is displayed.

Low battery warning (see page 15)

Current day/time (see page 11)



Current program period

Wake/Leave/Return/Sleep (see pages 11–13)

System status

Cool on: Cooling system is on.

Heat on: Heating system is on.

When Cool On is flashing, compressor protection is engaged (see page 14).

Temperature

The ambient (measured) temperature is normally displayed. To view the setpoint temperature, press the Up or Down button once. The setpoint temperature will appear for five seconds.

Programming and operation

Set the time and day

1. Press the **SET** button, then press ▲ or ▼ to set the clock time.
2. Press the **SET** button, then press ▲ or ▼ to select the day of the week.
3. Press **RUN** to save & exit.

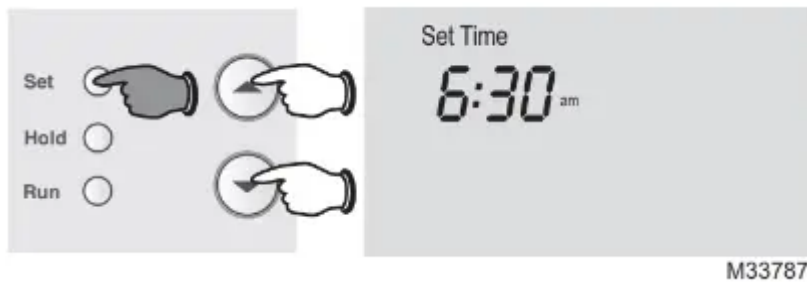

NOTE: If the clock flashes, the thermostat will follow your settings for the Monday “Wake” time period until you reset the time and day.

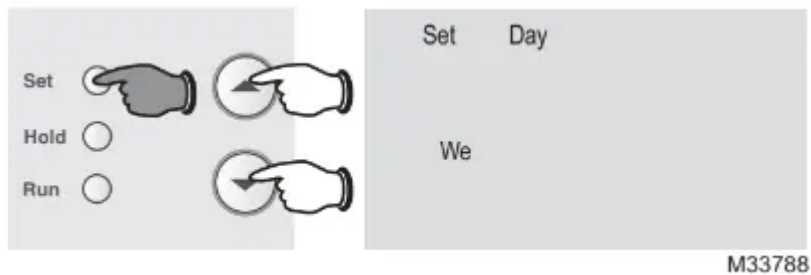

Program Schedule

You can program four time periods each day, with different settings for weekdays and weekends. We recommend the pre-set settings (shown in the table below), since they can reduce your heating/cooling expenses.

Wake - Set to the time you awaken and the temperature you want during the morning, until you leave for the day.

Leave - Set to the time you leave home and the temperature you want while you are away (usually an energy-saving level).

Return - Set to the time you return home and the temperature you want during the evening, until bedtime.

Sleep - Set to the time you go to bed and the temperature you want overnight usually an energy-saving level).

	Heat	Cool
Wake (6:00 am)	70°	78°
Leave (8:00 am)	62°	85°
Return (6:00 pm)	70°	78°
Sleep 10:00 pm)	62°	82°

NOTE: Leave and Return periods can be canceled on weekends.

To adjust program schedules (RTH221)

1. Press **SET** until Set Schedule is displayed.
2. Press ▲ or ▼ to set your Wake time (Mo-Su), then press **SET**.
3. Press ▲ or ▼ to set the temperature for this time period, then press **SET**.
4. Set time and temperature for the next time period (Leave). Repeat steps 2 and 3 for each time period.
5. Press **RUN** to save & exit.



NOTE: Make sure the thermostat is set to the system you want to program (Heat or Cool).

Program schedule override (temporary)

Press ▲ or ▼ to immediately adjust the temperature. This will temporarily override the temperature setting for the current time period.

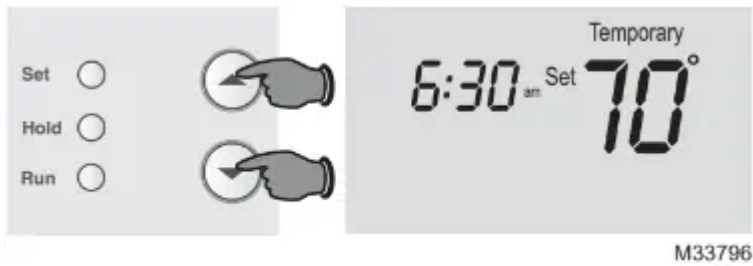

"Temporary" will appear on the display and the current program period will flash.

The new temperature will be maintained only until the next programmed time period begins (see page 11).

To cancel the temporary setting at any time, press **RUN**.

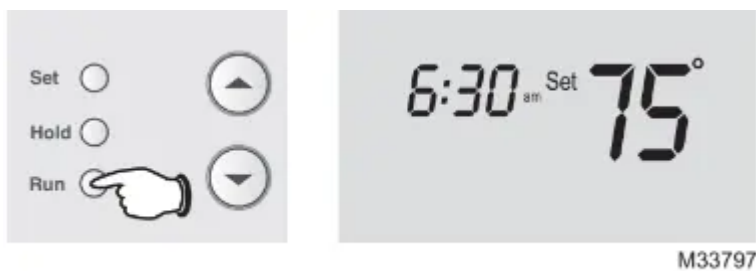

NOTE: Make sure the thermostat is set to the system you want to control heat or cool).

Program schedule override (permanent)

Press **HOLD** to permanently adjust the temperature. This will override the temperature settings for all time periods.

The "Hold" feature turns off the program schedule and allows you to adjust the thermostat manually, as needed.

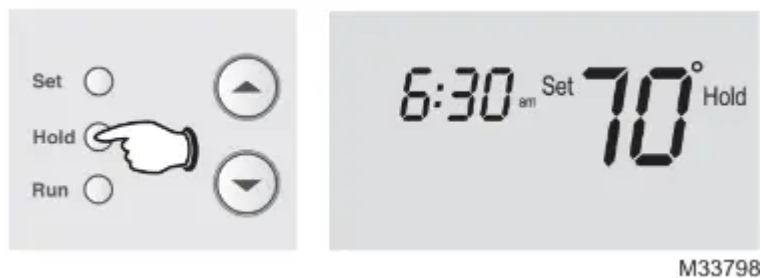

Whatever temperature you set will be maintained 24 hours a day, until you manually change it, or press **RUN** to cancel "Hold" and resume the program schedule.

NOTE: Make sure the thermostat is set to the system you want to control heat or cool).

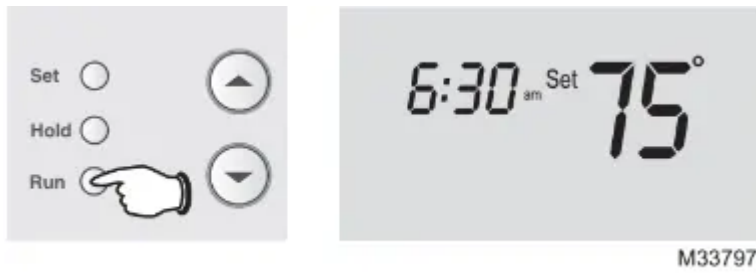

Built-in compressor protection

This feature helps prevent damage to the compressor in your air conditioning or heat pump system.

Damage can occur if the compressor is restarted too soon after shutdown. This feature forces the compressor to wait 5 minutes before restarting.

During the wait time, the display will flash the message Cool On (or Heat On if you have a heat pump). When the safe wait time has elapsed, the message stops flashing and the compressor turns on.



Battery replacement

Install two fresh AAA batteries when **Lo Batt** flashes on the screen. **Lo Batt** appears for 60 days before the batteries are depleted.

Replace batteries once a year, or when you will be away for more than a month.

Most settings are stored in non-volatile (permanent) memory. Only the clock and the day must be set after you replace the batteries.

Pull at bottom to remove thermostat from wallplate.

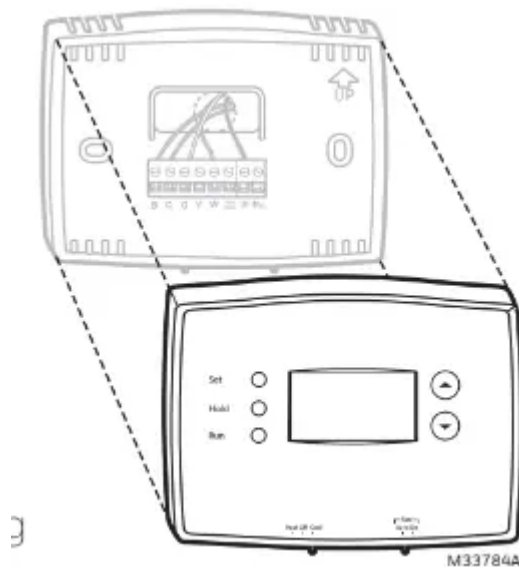

Set the System switch to Off before removing the batteries. Otherwise, the heating/cooling system could remain activated even when batteries are removed.

Turn thermostat over, insert fresh AAA alkaline batteries, then reinstall thermostat.

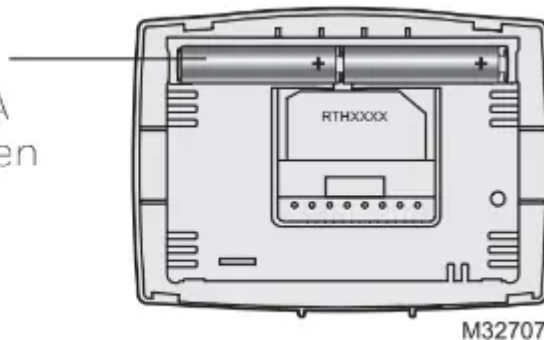

Troubleshooting

If you have difficulty with your thermostat, please try the following suggestions. Most problems can be corrected quickly and easily.

Display is blank

- Make sure fresh AAA alkaline batteries are correctly installed.

Heating or cooling system does not respond

- Set system switch to Heat. Make sure the temperature is set higher than the Inside temperature.
- Set system switch to Cool. Make sure the temperature is set lower than the Inside temperature.
- Wait 5 minutes for the system to respond.

Temperature settings do not change

Make sure heating and cooling temperatures are set to acceptable ranges:

- Heat: 40° to 90°F (4.5° to 32°C).
- Cool: 50° to 99°F (10° to 37°C).

"Cool On" or "Heat On" is flashing

- Compressor protection feature is engaged. Wait 5 minutes for the system to restart safely, without damage to the compressor.

"Heat On" is not displayed

- Set the System switch to Heat, and set the temperature level above the current room temperature.

"Cool On" is not displayed

- Set the System switch to Cool, and set the temperature level below the current room temperature.

1 year limited warranty

Resideo warrants this product, excluding battery, to be free from defects in workmanship or materials, under normal use and service, for a period of one (1) year from the date of first purchase by the original purchaser. If at any time during the warranty period the product is determined to be defective due to workmanship or materials, Resideo shall repair or replace it (at Resideo's option).

If the product is defective,

- i) return it, with a bill of sale or other dated proof of purchase, to the place from which you purchased it; or
- ii) call Resideo Customer Care at 1-800-468-1502. Customer Care will make the determination whether the product should be returned to the following address: Resideo Return Goods, 1985 Douglas Dr. N., Golden Valley, MN 55422, or whether a replacement product can be sent to you.

This warranty does not cover removal or reinstallation costs. This warranty shall not apply if it is shown by Resideo that the defect was caused by damage which occurred while the product was in the possession of a consumer.

Resideo's sole responsibility shall be to repair or replace the product within the terms stated above. RESIDEO SHALL NOT BE LIABLE FOR ANY LOSS OR DAMAGE OF ANY KIND, INCLUDING ANY INCIDENTAL OR CONSEQUENTIAL DAMAGES RESULTING, DIRECTLY OR INDIRECTLY, FROM ANY BREACH OF ANY WARRANTY, EXPRESS OR IMPLIED, OR ANY OTHER FAILURE OF THIS PRODUCT.

Some states do not allow the exclusion or limitation of incidental or consequential damages, so this limitation may not apply to you.

THIS WARRANTY IS THE ONLY EXPRESS WARRANTY RESIDEO MAKES ON THIS PRODUCT. THE DURATION OF ANY IMPLIED WARRANTIES, INCLUDING THE WARRANTIES OF MERCHANTABILITY AND FITNESS FOR A PARTICULAR PURPOSE, IS HEREBY LIMITED TO THE ONE YEAR DURATION OF THIS WARRANTY. Some states do not allow limitations on how long an implied warranty lasts, so the above limitation may not apply to you.

This warranty gives you specific legal rights, and you may have other rights which vary from state to state. If you have any questions concerning this warranty, please write Resideo Customer Care, 1985 Douglas Dr, Golden Valley, MN 55422 or call 1-800-468-1502.

Warning

This content is compiled from multiple sources and is provided for reference purposes only. It may not be complete or fully applicable to all situations. If you are unable to resolve your issue, please contact the product manufacturer or an authorized service provider for official support.