

SETTING UP YOUR SIDE-BY-SIDE

GETTING READY TO INSTALL THE REFRIGERATOR

Selecting the best location for the refrigerator

Choose:

- A location with easy access to a water supply.
- A location without direct exposure to sunlight.
- A location with a level floor.
- A location with enough space for the refrigerator doors to open easily.
- A location that provides sufficient space to the right, left, back, and top for air circulation.
- A location that allows you to move the refrigerator easily if it needs maintenance or service. • Do not install the refrigerator in locations where the temperature is over 110 °F (43 °C) or below 50 °F (10 °C).
- Do not locate the refrigerator where it may become wet. If the refrigerator does not have enough space, it can cause the bad influence to refrigeration efficiency and power consumption.

If your refrigerator has an ice maker, allow extra space at the back for the water line connections. When you install the refrigerator next to a fixed wall, you need a minimum clearance of 2" (50 mm) between the refrigerator and wall to allow the door to swing open.

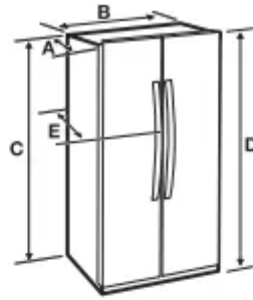

Model	RS22HDHPN**
Depth "A"	27" (687 mm)
Width "B"	35 7/8" (912 mm)
Height "C"	68 1/2" (1742 mm)
Overall Height "D"	70 1/8" (1782 mm)
Depth "E"	30" (762 mm)

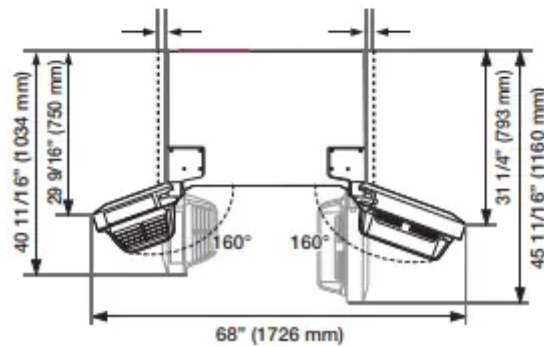

- Each measurement based on the design dimension, so it may differ depending on the measuring method.
- Make sure you disconnect the water supply line BEFORE removing the freezer door. See the next section on "Separating the Water Line" to avoid damage.

Flooring

For proper installation, you must place this refrigerator on a level, hard surface that is the same height as the rest of the floor. This surface should be strong enough to support a fully loaded refrigerator. To protect the finish of the flooring, cut a large section of the cardboard carton and place it under the refrigerator where you are working. When moving the refrigerator, you need to pull and push it straight forwards or back. Do not wiggle it from side to side.

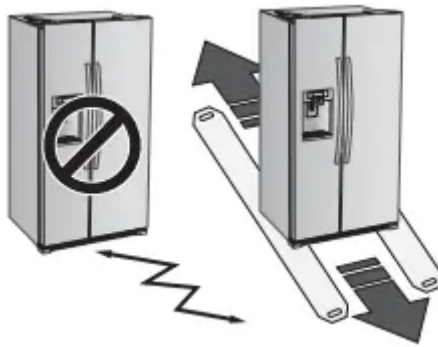

Required Tools (Not provided)

Philips screwdriver (+)	Flat-blade screwdriver (-)	Socket wrench (13/32") (10 mm)
Allen wrench (3/16") (5 mm)		

REMOVING THE REFRIGERATOR DOORS

If your entrance won't allow the refrigerator to pass easily through it, you can remove the refrigerator doors.

To remove the doors, follow the steps below. If you do not need to remove the doors, go to "Leveling the Refrigerator" on page 15.

1. Removing the front leg cover

Open both the freezer and refrigerator doors. Unscrew the three screws holding the front leg cover in place by turning them counter-clockwise. When the screws are loose, remove the front leg cover.

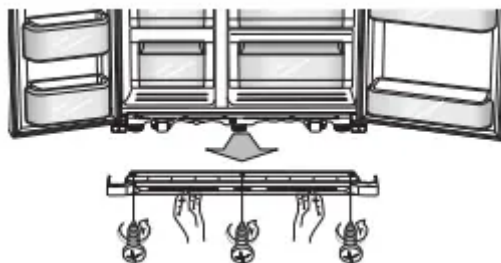

2. Separate the water supply line from the refrigerator Remove two water lines (orange for ice and the other for water) by pressing the coupler (1) and pulling the water line (2) away.

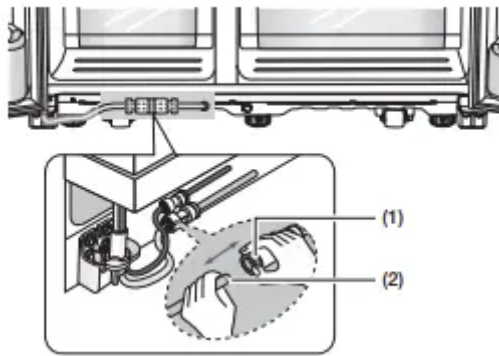

Do not cut the water line.

Gently separate it from the coupler.

3. Removing the freezer door

A few things to mention first.

- Make sure that you lift the door straight up so the hinges are not bent or broken.
- Be careful not to pinch the water tubing and wire harness on the door.
- Place doors on a protected surface to prevent scratching or damage.

1. With the Freezer door closed, remove the upper hinge cover (**1**) using a screwdriver, and then disconnect the wires by gently pulling them apart (**2**)

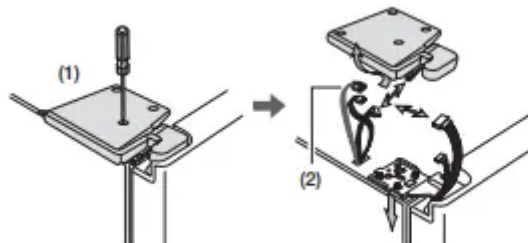

2. Remove the hinge screws (**3**) by turning them counterclockwise, and then take off the upper hinge (**4**). Be careful that the door does not fall on you as you are removing the hinge.

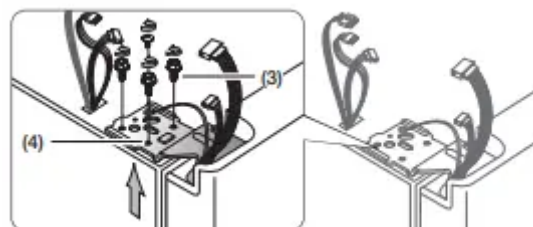

CAUTION: Be sure to keep track of all parts you are removing.

3. Next, remove the door from the lower hinge (**5**) by carefully lifting the door straight up (**6**).

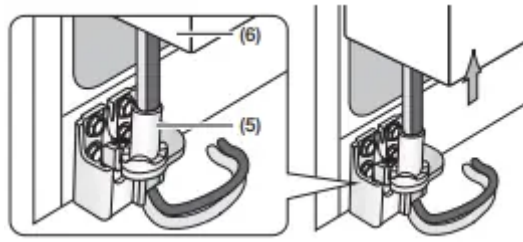

CAUTION: Be careful not to pinch the water tubing and wire harness on the door.

4. Remove the lower hinge (7) from the bracket (8) by gently lifting the lower hinge upwards

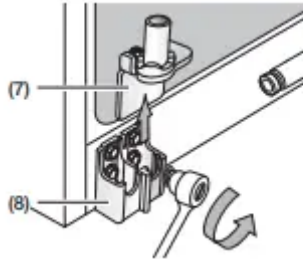

4. Remove the Fridge Door

1. With the door closed, remove the upper hinge cover (1) using a screwdriver.

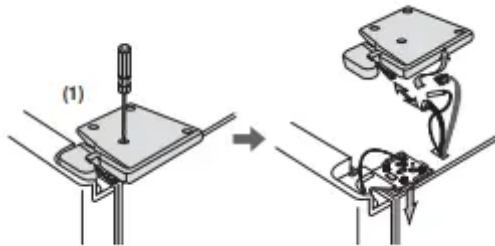

2. Remove hinge screws (3) and the ground screw (2) by turning counter-clockwise, and then take off the upper hinge (4). Be careful that the door does not fall on you as you are removing the hinge.

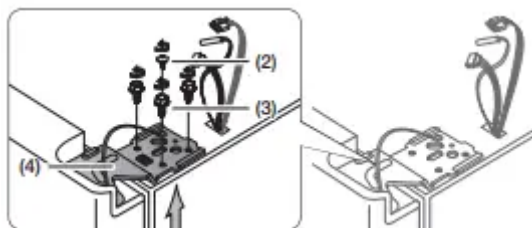

CAUTION: Be sure to keep track of all parts you are removing.

3. Remove the door from the lower hinge (5) by lifting the door straight up (6).

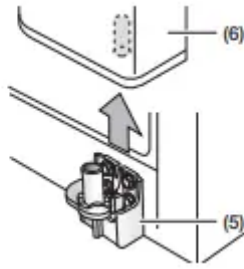

4. Remove the lower hinge (7) from the bracket (8) by gently lifting the lower hinge upwards.

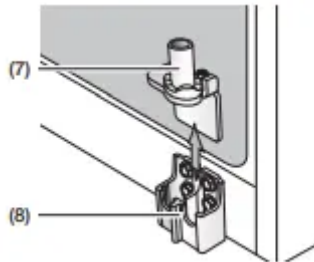

5. After you have removed the Fridge and Freezer doors, move the refrigerator to its installation location.

Re-attaching the Fridge Door

To re-attach the fridge door, replace parts in reverse order.

Re-attaching the Freezer Door To re-attach the freezer door, replace parts in reverse order. Re-attaching the Water Supply Lines

1. The Water Lines must be fully Inserted into the center of the transparent coupler to prevent water leakage from the dispenser.
2. Insert the 2 clips in the install pack as shown below, and then confirm that each clip holds the line firmly.

Center of Transparent coupler

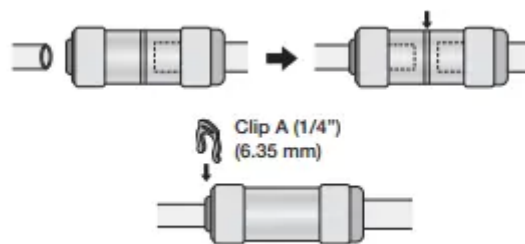

CAUTION

- Make sure the color of the water lines match.
- Keep the clips out of the reach of children and make sure that children do not play with them or put them into their mouths.

LEVELING THE REFRIGERATOR

Make sure the refrigerator is level so that you can make final adjustments. Use a level to test if the refrigerator is level both side to side and back to front. If the refrigerator is not level, you will not be able to get the doors perfectly even, which may cause moisture condensation and increased energy bills.

The front of the refrigerator is also adjustable.

Before levelling the refrigerator, remove the front leg cover.

Open both the freezer and refrigerator doors. Unscrew the three screws holding the front leg cover in place by turning them counter-clockwise. When the screws are loose, remove the front leg cover.



When the Freezer part is lower than the Fridge part.

Insert a flat-blade screwdriver into a slot on the Freezer Leg, then turn it clockwise.

When the Fridge part is lower than the Freezer part.

Insert a flat-blade screwdriver into a slot on the Fridge Leg, then turn it clockwise.

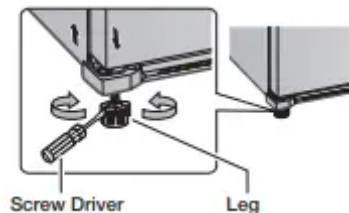

Refer to the next section for the best way to make very minor adjustments to the doors.

MAKING MINOR ADJUSTMENTS TO THE DOORS

A level refrigerator is necessary for getting the doors perfectly even. Make sure your refrigerator is level before you begin. If you need help leveling, review the previous section on leveling the refrigerator.

When the door of the freezer is higher than the fridge



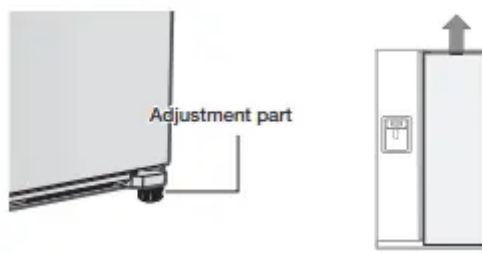

The process for adjusting each door is the same. Open the doors and adjust them, one at a time, as follows:

1. Unscrew the nut (**1**) from the lower hinge until it reaches the upper end of the bolt (**2**).

When you release the nut (**1**), make sure that you use the Allen wrench provided (**3**) to loosen the bolt (**2**) in a counterclockwise direction. You should then be able to unscrew the nut (**1**) with your fingers.

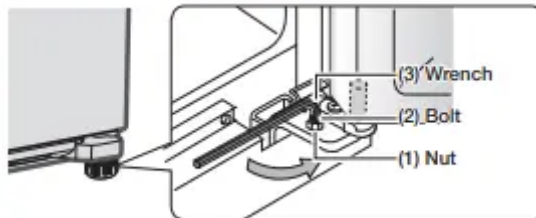

2. Adjust the height difference between the doors by turning the bolt (**2**) clockwise or counter clockwise.

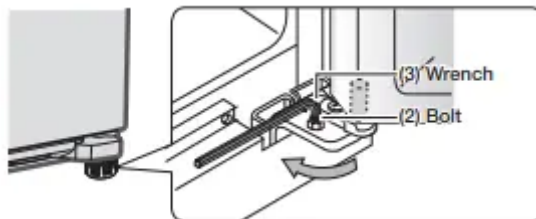

When you turn clockwise, the door will move up.

3. After adjusting the doors, turn the nut (**1**) clockwise until it reaches the lower end of the bolt, then tighten the bolt again with the wrench (**3**) to fix the nut in place (**1**).

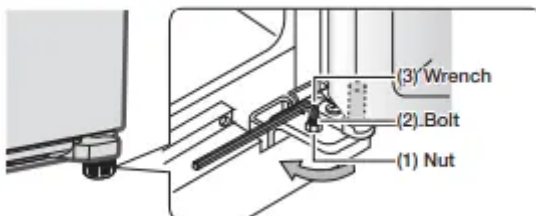

If you do not secure the nut firmly, the bolt may release.

Installing the water filter.

Before installing the water filter, please remove the top shelf.

1. Remove the water filter cover (**1**).
2. Remove the fixed cap by turning it counter clockwise. Keep the cap in a safe place for later use if you don't use a filter.
3. Remove the water filter from the box and put a replacement indicator sticker on the filter as shown.

Place a sticker on the filter with a date six months in the future. For example, if you install the water filter in March, put the "SEP" sticker on the filter to remind you to replace it in September. That way you'll know when it is time to replace the filter. Normal filter life is about 6 months.

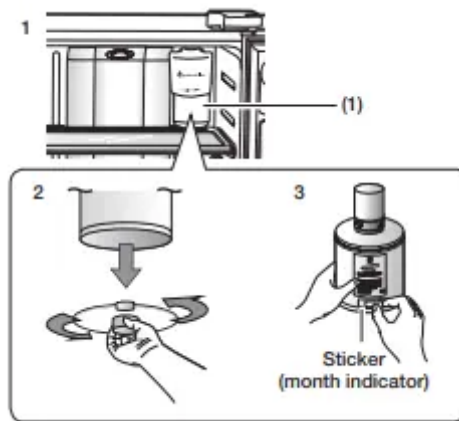

4. Remove the filter cap and insert the filter into the filter housing.
5. Slowly turn the water filter 90° clockwise to align the indicator mark on the filter with lock indicator on the filter housing.

Make sure to align the water filter label mark with the center of the lock indicator as illustrated above, right. Do not over-tighten.

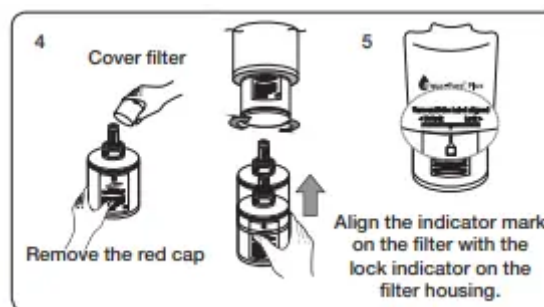

A newly installed water filter cartridge may cause water to briefly spurt from the water dispenser. This is caused by air getting into the line. It should pose no problem to operation.

INSTALLING THE WATER DISPENSER LINE

A water dispenser is one of the helpful features on your new Samsung Refrigerator. To help promote better health, the Samsung water filter removes unwanted particles from your water. However, it does not sterilize or destroy microorganisms. You may need to purchase a water purifying system to do that. The water line also connects to the ice maker. For the ice maker to

operate properly, water pressure of 20 ~ 125 psi (138 ~ 862 kPa) is required. If the refrigerator is installed in an area with low water pressure (below 20 psi), you can install a booster pump to compensate for the low pressure. After you have connected the water line, make sure the water storage tank inside the refrigerator is properly filled. To do this, press the water dispenser lever until water runs from the water dispenser.

Water line installation kits are available at extra cost from your dealer. We recommend using a water supply kit that contains copper tubing.

Connecting to the water supply line

1. First, shut off the main water supply line and turn the ice-maker off.
2. Locate the nearest cold water drinking water line.
3. Install the pipe clamp and shut off valve.
4. Connect the water line installation kit to the shut off valve.

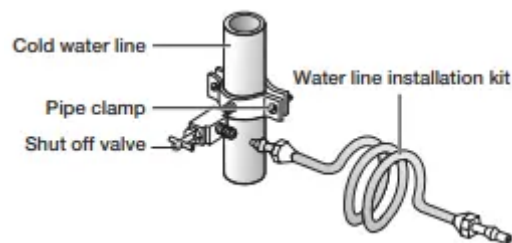

Connecting the water supply line to the refrigerator

There are several items that you need to purchase to complete this connection. You may find these items sold as a kit at your local hardware store.

Use Copper Tubing	Use Plastic Tubing
<ul style="list-style-type: none"> • ¼" copper tubing • ¼" compression nut (1pc) • Ferrule (2pc) 	<ul style="list-style-type: none"> • ¼" plastic tubing → Molded end (Bulb) • ¼" compression nut (1pc)

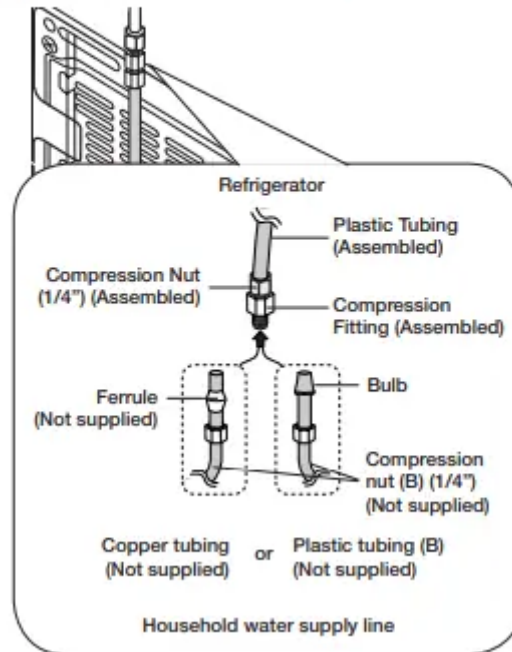

1. Connect the household water line to the assembled compression fitting.

- If you are using copper tubing, slip the compression nut (**B**) (not supplied) and ferrule (not supplied) on the copper tubing (not supplied) as shown.

- If you are using plastic tubing (**B**), insert the molded end (Bulb) of the plastic tubing (**B**) into the compression fitting.

CAUTION

Do not use plastic tubing (**B**) without the molded end (Bulb).

2. Tighten the compression nut (**B**) onto the compression fitting. Do not over-tighten the compression nut (**B**).

3. Turn the water on and check for any leaks inside the refrigerator, around the water filter, and in any connection areas. If you find water drops or leaks, turn off the main water supply. If the leaks are in the connection areas, check the connections and, if necessary, tighten. If there are leaks in the refrigerator, check the water filter and confirm it is in the locked position. Turn on the water supply and check for leaks again.

4. Plug in the refrigerator.

5. Flush 3 gallons of water through the filter before drinking or using the water from the refrigerator. (Flush approximately 6 minutes.) This will clean the water supply system and remove air from the lines.

To flush, press the Water button, and then press a large glass or cup against the water dispenser lever. Fill the glass, empty it into the kitchen sink after it is filled, and then repeat.

Additional flushing may be required in some households.

6. Open the refrigerator door and make sure there are no water leaks coming from the water filter.

- After you turn on the refrigerator, let the ice maker make ice for 1 to 2 days. Over that period of time, throw out the first 1 or 2 buckets of ice the ice maker makes to ensure all impurities have been removed from the water line.
- Only connect the water line to a drinkable water source.
- If you have to repair or disassemble the water line, cut off 1/4" of the plastic tubing to make sure you get a snug, leak-free connection.
- You can test the water line quickly using a paper cup.

Under normal conditions, the water dispenser can fill a 5.75 oz. (170 cc) cup in about 10 seconds.

COMPLETING THE SETUP

Now that you have your new refrigerator installed in place, you are ready to set up and enjoy the features and functions of the appliance. By completing the following steps, your refrigerator should be fully operational.

1. Make sure your refrigerator is in an appropriate location with reasonable clearance between it and the wall. Refer to installation instructions in this manual.
2. Once the refrigerator is plugged in, make sure the interior light comes on when you open the doors.
3. Set the Temperature control to the coldest temperature and wait for an hour. The freezer will get slightly chilled and the motor will run smoothly. Reset the refrigerator and freezer to the temperatures you want.
4. After you plug the refrigerator in, it will take a few hours to reach the appropriate temperature. You can store food and drinks in the refrigerator after the temperature is sufficiently cool.

If condensation or water drops appear on both sides of the fridge door's central part, turn the Energy Saver mode off after removing the condensation. (See the explanation of the Energy Saver button in "Using the Control Panel" on page 20.)

OPERATING THE SAMSUNG SIDE-BY-SIDE REFRIGERATOR

USING THE CONTROL PANEL / DIGITAL DISPLAY

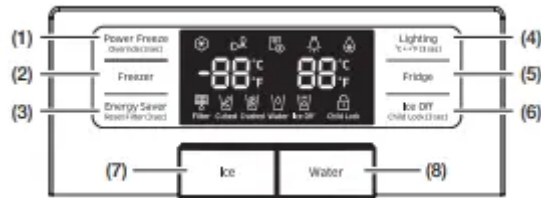

• **(1) Power Freeze / Override (3sec)**

1. Press the Power Freeze button to decrease the time needed to freeze products in the Freezer. This can be helpful if you need to quickly freeze items that spoil easily or if the temperature in the freezer has warmed dramatically. (For example, if the door was left open).
2. The Override function activates/ deactivates Smart Grid (page 25). Press the Power Freezer/Override button for 3 seconds to set/clear the Override function.

• **(2) Freezer**

Press the Freezer button to set the freezer temperature. You can set the temperature between 5 °F (-15 °C) and -8 °F (-23 °C).

• **(3) Energy Saver / Reset Filter (3sec)**

1. For better energy efficiency, press the Energy Saver button. If condensation occurs on the doors, press again to turn the Energy Saver Button function off.
2. When you change the water filter, press and hold this button for 3 seconds to reset the water filter indicator.

• **(4) Lighting / °C ↔ °F (3sec)**

1. Press the Lighting button to turn on the dispenser LED lamp.
2. To switch the temperature units between °C and °F, press and hold this button for 3 seconds. Each time you press and hold the button for 3 seconds, the °C and °F temperature modes alternate and the °C or °F icon lights up, indicating your selection.

• **(5) Fridge**

Press the Fridge button to set the Fridge temperature. You can set temperature between 44 °F (7 °C) and 34 °F (1 °C). The Power Cool function starts operating when you set the temperature lower than 34 °F (1 °C).

If you select “Power Cool”, the inside temperature of the Fridge will decrease for about two and a half hours. When the Power Cool mode exits, the notch is reset to the factory default temperature.

• **(6) Ice Off / Child Lock (3sec)**

1. Press the Ice Off button to turn the ice making function off.

2. Press and hold this button for 3 seconds, to turn on the Child lock and lock all the panel buttons, including the Ice button and the dispensers. To cancel this function, press and hold this button for 3 seconds again.

(7) Ice

Press the Ice button to choose cubed or crushed ice.

- **(8) Water**

Press the Water button for water.

USING THE DIGITAL DISPLAY

“ Freezer Temp.” indicates the current Freezer temperature.

“ Fridge Temp.” indicates the current Fridge temperature.

When not in use, the Display will turn off. This is normal operation.

Power Freeze



This icon lights when you activate the “Power Freeze” feature. “Power Freeze” is great for times when you need a lot of ice. When you have enough, just press the button again to cancel the “Power Freeze” mode.

When you use this function the energy consumption of the refrigerator will increase. Remember to turn it off when you don't need it and return the freezer to your original temperature setting.

Energy Saver



This icon lights when you activate the “Energy Saver” function.

The Energy Saver function is automatically set to “ON” when power is supplied to the Refrigerator. If condensation appears on the doors, turn the Energy Saver function off.

E-Smart



The E-Smart icon lets you check the status of the refrigerator's AP connection (network connection).

- When connected to an AP: The E-Smart icon is on.
- When not connected to an AP: The E-Smart icon is off.

Lighting



This icon lights when you activate the “Lighting” feature. When the icon is lit, the dispenser light (under the display) is on continuously. If you want the Dispenser lamp to come on only when someone uses the dispenser, press the Lighting button to turn the continuous mode off.

Power Cool



This icon lights when you activate the “Power Cool” feature (refer to number 5, Fridge Button on Page 20 to select this function). For a quick fridge cool down, use “Power Cool”. If you select “Power Cool”, the inside temperature of the Fridge will decrease for about two and a half hours.

Filter Indicator



This icon lights when you need to change the filter, usually after the refrigerator has dispensed about 300 gallons of water (after about 6 months). After you install the new water filter, reset the filter indicator by touching and holding the “Energy Saver” button for 3 seconds.

- If water is not dispensing or dispensing slowly, you need to replace the water filter because the water filter is clogged.
- Some areas have large amounts of lime in their water, which causes the water filter to clog more quickly.

Cubed Ice, Crushed Ice



Enjoy cubed or crushed ice by selecting your preference on the digital control panel. The ice type light indicates the type of ice that is currently chosen.

Water



This icon lights when you activate the “Water” feature.

Ice Off



This icon lights when you activate the “Ice Off” feature. The ice maker is turned off and will not produce ice.

When ICE OFF blinks on the display panel, reinsert the ice bucket and/or make sure it’s installed properly.

Child Lock



This icon lights when you activate the “Lock” feature. When the Child Lock icon is lit, all the panel buttons, including the Ice button and the dispensers, are locked and de-activated. Press and hold the Ice Off / Child Lock button for 3 seconds to turn Child Lock off and re-activate the panel buttons.

Cooling Off Mode

Cooling Off mode (also called Shop mode), is designed for use by retailers when they are displaying refrigerators on the shop floor. In Cooling Off mode, the refrigerator’s fan motor and lights work normally, but the compressors do not run, and the refrigerator and freezer do not get cold. To start Cooling Off mode, touch and hold the Power Freeze button and the Freezer button for 5 seconds during normal operation. The refrigerator chime sounds and OFF appears on the display. To cancel Cooling Off mode, touch and hold the Power Freeze and Freezer buttons again for 5 seconds, until the chime sounds.

Important: If you see the OFF code on your refrigerator’s display, your refrigerator is in Cooling Off mode. Follow the directions above to cancel.

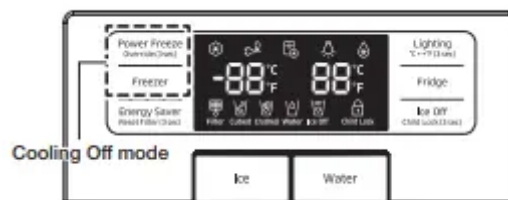

Display Off

To energy conservation the Panel Display turns off automatically under the following conditions: When no button has been pressed, when no doors are open, or when no Dispenser Lever has been pushed for a period of time. However, the icon indicating your Water or Cubed / Crushed Ice selection, will stay on. When you press a button, open a door, or push a Dispenser Lever, the Panel Display will turn on again.

Except for the Water and Cubed / Crushed Ice buttons, all function buttons will become operational after you remove your finger from the button you are currently pressing.

E-SMART Refrigerator Features

How to get the most out of your E-Smart refrigerator.

Getting Connected

To use the Smart Grid (Demand Response) and E-Smart function on your Refrigerator, you need the following devices and apps:

- Devices: 1) Wireless Router, 2) Samsung E-Smart Refrigerator, 3) Smartphone (Recommended: Galaxy S4, Galaxy Note3/ Android OS Jelly bean).



- Applications: 1) “Samsung E-Smart App” from the Google Play Store or Samsung Apps.

In addition, you need to:

- Connect the Refrigerator and the Smartphone to the same Wi-Fi network in your home.
- Install and run Samsung E-Smart App on your Smartphone (to use the Samsung E-Smart function).

In addition, to use the Smart Grid (Demand Response) function, you must Register for the service with your electric company. The company must have an EMS (Energy Management System) that supports SEP (Smart Energy profile).

Downloading the E-Smart App and Connecting the Refrigerator to your Network

1. On your Smartphone, connect to the app store (e.g. Google Play, etc.).
2. Search for the app using “Samsung E-Smart Ref.” as the keyword.
3. Download the app and install it on your phone.
4. Launch the app. The network configuration screen appears.
5. Configure the AP information (SSID, Password, etc.) on the app screen.
6. Configure the network settings according to the instructions in the app.
7. On the refrigerator, press and hold the Fridge and Energy Saver buttons at the same time for 3 seconds. The refrigerator enters the AP mode.

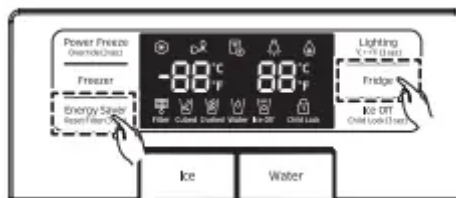

8. If you have completed the network settings properly, the app shows the home screen.

- Please confirm your the Internet devices (AP, Smartphone) are working properly before configuring the network settings.

- This refrigerator supports the IEEE 802.11 a/b/g/n protocols. Samsung Electronics recommends IEEE 802.11n.

- To connect the refrigerator to a wireless network, you have to connect the refrigerator to an AP (router or modem). If the AP supports DHCP, you can connect the refrigerator to the Internet using DHCP or a fixed IP address.

- Set the channel of the AP to one not currently being used. If the channel set for the AP is being used by another device nearby, it may result in interference.

- Most wireless networks allow you to configure network security settings. If your network has a security password, you must enter the password to connect to the network.

The refrigerator supports the following wireless security modes and encryption types:

- Security Mode: WEP, WPAPSK, WPA2PSK
- Encryption Type: WEP, TKIP, AES (WPA2PSK and AES are recommended.)
- The app supports indoor control only.
- The Samsung E-Smart Ref. app is optimized for Samsung Electronics Smartphones (Galaxy S4 , Galaxy Note 3).

For other Smartphones, some functions may work differently.

MAC Address Display Mode

This function displays the MAC address of the Wi-Fi module on the refrigerator display. The refrigerator displays the MAC address of the Wi-Fi module for 1 minute.

1. Press and hold the Power Freeze and Energy Saver buttons at the same time for 3 seconds.

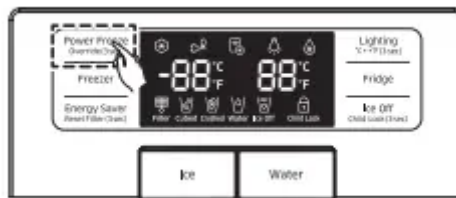

2. A Buzzer sounds. Four of the twelve Mac address of the Wi-Fi module are displayed in turns in the freezer and fridge temperature displays for 1 minute. For example, if the Wi-Fi module's MAC address is "11-22-33-44-55- 66", the MAC address is displayed as follows: "11 22" → "33 44" → "55 66" → ---- → "11 22" for 1 minute.

3. After 1 minute, the display returns to the normal state and the Buzzer sounds again.

If the Mac addresses are not available or there is no Wi-Fi module, '----' is displayed on the freezer and fridge temperature displays.

SMART GRID Function (Demand Response)

When the refrigerator operates in SMART GRID (Demand Response) mode, the E-Smart Refrigerator function can control energy usage or delay the operation of some functions to save money when energy prices or demand are the highest.

You can deactivate the SMART GRID (Demand Response) function at any time. (Using the Override On/Off function)

To use the SMART GRID (Demand Response) function, you need a separate contract with your utility company.

Using the SMART GRID (Demand Response) Function

This feature monitors energy prices and demand information from your utility company and sends notifications to the refrigerator to run high energy-consuming tasks during off-peak times when electricity costs and demand are lower.

If the refrigerator receives a control signal from the Utility Company, the refrigerator will display the DAL (L3) ~ TALR (L4) levels on the refrigerator display and control the power consumption according to the level.

[Exception condition] The DAL and TALR control signals from an utility company work as long as product performance is maintained.

If the refrigerator receives the SMART GRID (Demand Response) signal (DAL or TALR), the refrigerator will operate in Delay Appliance Load (Display: L3) or Temporary Appliance Load Reduction (Display: L4) mode.

- Delay Appliance Load (L3): The refrigerator responds to a DAL signal by providing a moderate load reduction for the duration of the delay period. This function controls functions that consume a lot of energy such as adjusting the Cooling system, running the defrost cycle, and making ice.

- When the refrigerator operates in DAL (L3) mode, "L3" is displayed on the refrigerator display.

- DAL mode is automatically deactivated after it lasts for the amount of time stipulated by the DAL signal (max. 4.5 hours) or when the Override key is pressed.

- Temporary Appliance Load Reduction (L4): The refrigerator responds to a TALR signal by aggressively reducing the load for a short time period. This function reduces energy consumption by stopping the compressor and controlling the functions that consume a lot of energy such as the defrost cycle and making ice.)

- When the refrigerator operates in TALR (L4) mode, "L4" is displayed on the refrigerator display.

- TALR (L4) mode is automatically deactivated after it lasts for the received duration (max. 15 minutes), or when the Override key is pressed. The mode is immediately deactivated and the refrigerator returns to the normal state when the door is opened or closed, or the dispenser is used.

Override Mode

When you want to ignore the SMART GRID (Demand Response) signal from the Utility Company, you can activate OVERRIDE mode. If OVERRIDE mode is activated, the SMART GRID (Demand Response) signal is ignored and the refrigerator will not be controlled by the Utility Company.

Activating and deactivating Override mode

1. Press and hold the [Power Freeze] button for 3 seconds.

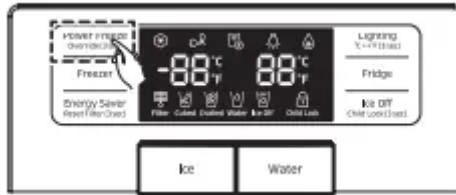

2. A buzzer sounds and `Or` and `on` is displayed in the freezer and fridge temperature displays for 5 seconds.
3. If the refrigerator receives a SMART GRID (Demand Response) signal from the Utility Company, `Or` is displayed in the freezer temperature display.
4. To deactivate OVERRIDE mode, press and hold the [Power Freeze] button for 3 seconds.

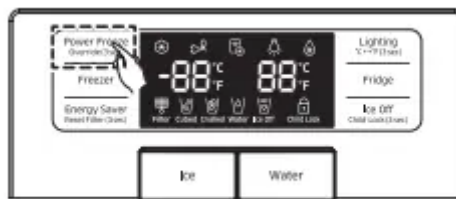

5. A buzzer sounds and `Or` and `oF` appears in the freezer and fridge temperature displays for 5 seconds.

Alternatively, you can activate or deactivate OVERRIDE mode using the app.

Using the E-SMART Function

The E-SMART function enables you to control and monitor your E-Smart refrigerator remotely for your convenience.

- To use the E-SMART refrigerator functions, you have to install the corresponding app first.
- The app supports indoor control only.

1. Operational Status, User Settings & Messages.

- You can view the freezer and fridge temperature settings.
- You can receive an alarm when the freezer or fridge door is open for 2 minutes.
- The door-open alarm indicator appears on the status bar of the top area of your mobile phone.
- You can check the DR and Override status.
- You can check the operational condition of the ice maker in the freezer.

2. Remote Management.

- Power Freeze Setting : You can remotely activate the Power Freeze function.
- Power Cool Setting : You can remotely activate the Power Cool function.
- Ice On/Off Setting : You can remotely set up the Ice On/Off Setting function.

3. Energy Consumption Reporting.

- Shows the accumulated power consumption. Power consumption data is updated every 10 minutes.

The energy consumption report may differ from the power consumption specifications of the product depending on the operating environment and the stored food.

4. Delay Defrost Capability.

- The Delay Defrost Capability function saves energy by delaying the defrost operation to a time specified by the user. You can configure the time, and this function will save energy during the specified period in a 24 hour cycle. If the time is not set, the function works with the default time settings. The default time settings are below:

- 6 am to 10 am : 1st. November ~ 30th. April
- 3 pm to 7 pm : 1st. May ~ 31th. October

To change the time setting for the Delay Defrost Capability

You can change the time setting for the Delay Defrost Capability on the app.

Provision for Open Access to the Connected Product Requirements

1. SGIP Open Standards (Smart Energy Profile 2.0 <http://www.csep.org/>)

- Energy Consumption Reporting
- Demand Response

2. Samsung OPEN API

- Operational Status, User Settings & Messages
- ICE Maker Status: GET /external/ icestatus?icegetstatus=opt (relevant to the energy consumption of the product
- 1) - Door Open Alarm: GET /devices/0/ Door?type=opt (relevant to the energy consumption of the product
- 2) - DR Status: GET /external/drlc?drgetstatus=opt
- Delay Defrost Capability
- Set Schedule of the Defrost Delay: POST / devices/0/defrost/addSchedule
- Get Schedule of the Defrost Delay : GET / devices/0/defrost/getSchedule
- Delete Schedule of the Defrost Delay: POST / devices/0/defrost/delSchedule
- Defrost Delay On/OFF: PUT /devices/0/defrost/ delayevent.

CONTROLLING THE TEMPERATURE



The freezer temperature can be set between 5 °F (-15 °C) and -8 °F (-23 °C) to suit your particular needs. Press the Freezer button repeatedly until the desired temperature is shown in the temperature display.

Fahrenheit: 0 °F → -1 °F → -2 °F → -3 °F → -4 °F → -5 °F → -6 °F → -7 °F → -8 °F → 5 °F → 4 °F → 3 °F → 2 °F → 1 °F → 0 °F.

Centigrade: -18 °C → -19 °C → -20 °C → -21 °C → -22 °C → -23 °C → -15 °C → -16 °C → -17 °C → -18 °C.

Keep in mind that foods like ice cream may melt at 4 °F (-15.5 °C). The temperature display will move sequentially from 5 °F (-15 °C) to -8 °F (-23 °C).

When the display reaches 5 °F (-15 °C), it will begin again at -8 °F (-23 °C).

Controlling the Fridge temperature



The refrigerator temperature can be set between 44 °F (7 °C) and 34 °F (1 °C) to suit your particular needs. Press the Fridge button repeatedly until the desired temperature is shown in the temperature display.

Fahrenheit: 37 °F → 36 °F → 35 °F → 34 °F → Power Cool → 44 °F → 43 °F → 42 °F → 41 °F → 40 °F → 39 °F → 38 °F → 37 °F.

Centigrade: 3 °C → 2 °C → 1 °C → Power Cool → 7 °C → 6 °C → 5 °C → 4 °C → 3 °C.

The temperature control process for the Fridge works just like the Freezer process. Press the Fridge button to set your desired temperature. After a few seconds, the Fridge will begin tracking towards the newly set temperature. This will be reflected in the digital display.

- The temperature of the freezer or the refrigerator may rise if you open the doors too frequently, or if a large amount of warm or hot food is placed in either side.

- This may cause the digital display to blink. Once the freezer and refrigerator return to their normal set temperatures the blinking will stop.
- If the blinking continues, you may need to “reset” the refrigerator. Unplug the appliance, wait about 10 minutes, and then plug it back in.

USING THE ICE AND COLD WATER DISPENSER

When Ice Off blinks on the display panel, reinsert the ice bucket and/or make sure it's installed properly.

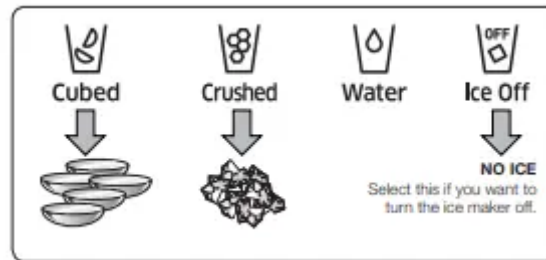

Using the Water Dispenser

Press the Water button. Place your cup under the water outlet, and then push gently against the dispenser pad. Make sure the glass is in line with the dispenser to prevent the water from splashing out.

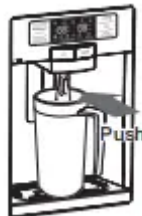

To get cooler water:

- The dispensed water is cool, not icy cold.
- When you want colder water with ice, dispense ice into your glass first before filling it with water to prevent water from splashing out. Using the ice Dispenser Press the Ice button to select the type of ice you want.

Place your cup under the ice outlet, and then push gently against the dispenser pad. Make sure the glass is in line with the dispenser to prevent the ice from bouncing out.

If you select Cubed Ice after using the Crushed Ice feature, a small amount of residual crushed ice might be produced.

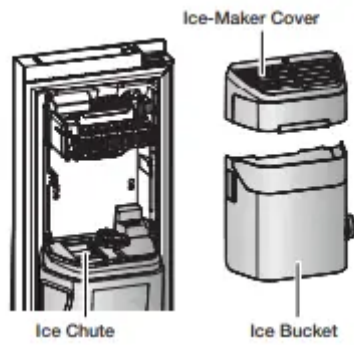

STORING FOOD

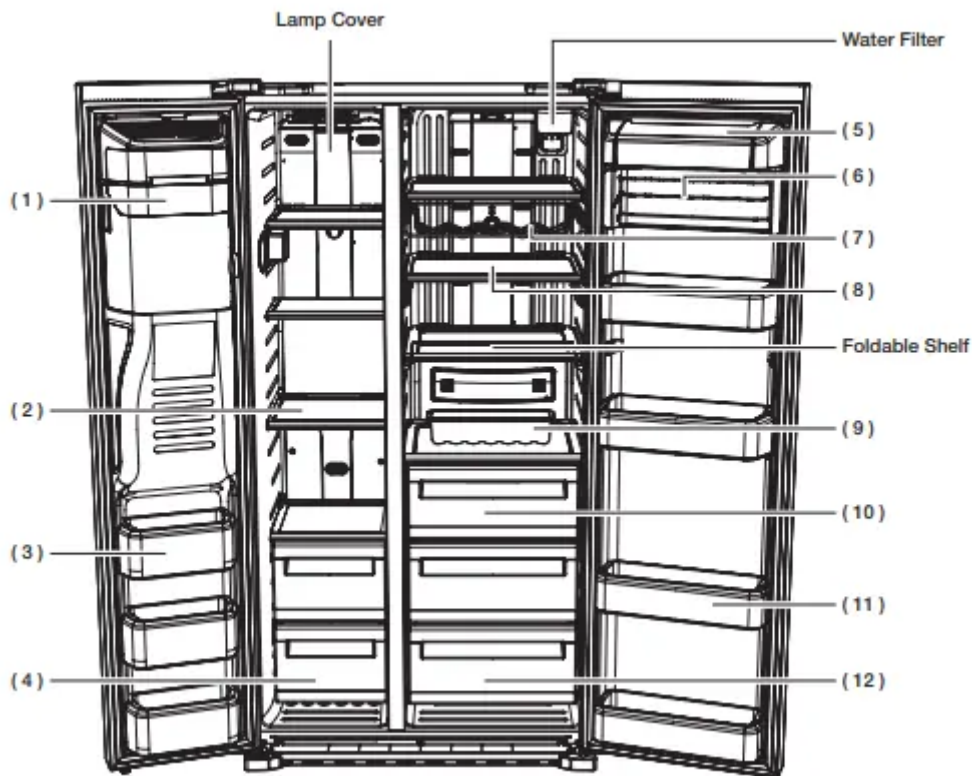

Storing food in the freezer

(1) Ice Maker Bucket

Designed to store lots of ice easily.

WARNING Do not put your fingers, hands or any other objects in the ice chute or the ice maker bucket. Doing so can cause personal injury or material damage

(2) Shelves

Can be used to store all types of frozen food.

(3) Door Bins

Can be used for small packages of frozen food.

(4) Drawers

Best used to store meats or dry foods. Stored food should be wrapped securely using foil or other suitable wrapping materials or containers. Storing food in the fridge

(5) Dairy Bin

Can be used to store smaller dairy items like butter or margarine, yogurt, or cream-cheese bricks.

(6) Tilt Can Carry

Can be used to store beverage cans or bottles.

(7) Wine Rack (optional)

Helps wine maintain its taste by providing an optimized place for storing your wine bottles.

(8) Shelves

Designed to be crack-resistant. They can be used to store all types of food and drinks. Circular marks on the glass surface are a normal phenomenon and can usually be wiped clean with a damp cloth.

(9) Egg Container

Best place to keep eggs. Place the egg tray on a shelf for easy access.

(10) Fresh Drawer

Helps to preserve the taste of food and prolongs its freshness. Use to store bread and cake.

(11) Door Bins

Designed to handle large, bulky items such as gallons of milk or other large bottles and containers.

(12) Fruit & Vegetable Drawer

Used to preserve the freshness of your stored vegetables and fruits. Bottles should be stored tightly together so that they do not tip and fall out when the refrigerator door is opened.

WARNING

- If you plan to go away for a significant time, empty the refrigerator and turn it off. Wipe excess moisture from the inside of the refrigerator and leave the doors open. This helps keep odor and mold from developing.

- If you do not intend to use the refrigerator for a long period of time, pull out the power plug. - Deteriorating power cord insulation may cause a fire.

REMOVING THE FREEZER/ FRIDGE ACCESSORIES

Cleaning and rearranging the interior of the freezer is a snap.

1. Shelves (Freezer/Fridge)

- Remove the shelf by pulling it out to the point where there is a gap in the shelf support as shown in the circled figure. Then, lift up the right side or the shelf and pull it out.

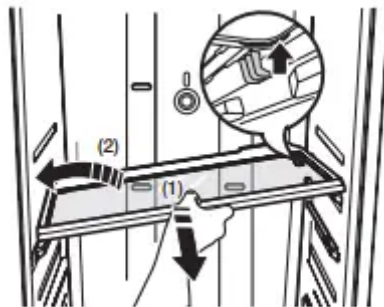

2. Door bin

- Remove the Door Bin by holding it with both hands and then gently lifting it up.

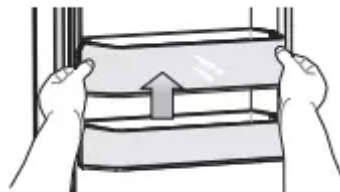

3. Drawer

- Remove the Drawer by pulling it out and slightly lifting it up.

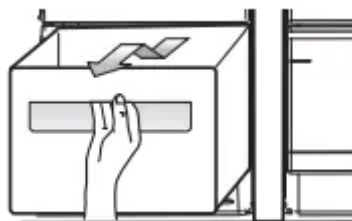

4. Drawer Cover

- Remove all Drawers before removing the cover.
- Pull the cover out to the point where there is a gap in the support as shown in the circled figure. Then, lift up the right side of the cover and pull it out.

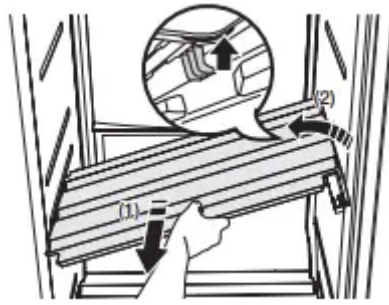

5. Ice Bucket (Freezer)

- Remove the Icemaker Bucket by lifting it up and pulling it out slowly.
- Grip the handle as shown in the figure.
- Remove the Ice Bucket slowly to prevent damage.



Do not use excessive force when removing the drawer cover. Otherwise, the cover may break and cause injury.

Before removing any accessories, make sure that no food is in the way. When possible, remove the food altogether to reduce the risk of accidents.

CLEANING THE REFRIGERATOR

Cleaning the Interior

Clean the inside walls and accessories with a mild detergent, and then wipe dry with a soft cloth. You can remove the drawers and shelves for a more thorough cleaning. Just make sure to dry them before putting them back into place.



Cleaning the Exterior

Wipe the control panel and digital display with a damp, clean, soft cloth. Do not spray water directly on the surface of the refrigerator. The doors, handles, and cabinet surfaces should be cleaned with a mild detergent, and then wiped dry with a soft cloth. To keep your appliance looking its best, polish the exterior once or twice a year.

WARNING Do not use benzene, thinner, car detergent, or Clorox to clean the exterior of your refrigerator. These substances may damage the surface of the appliance and can cause a fire.

Cleaning the Rubber door seals

If the rubber door seals are dirty, the doors may not close properly, and the refrigerator will not operate efficiently.

Keep the door seals free of grit or grime by cleaning the doors with a mild detergent and damp cloth.

Wipe dry with a clean, soft cloth.

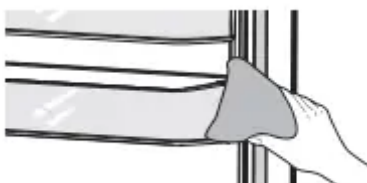

CAUTION

Do not spray the refrigerator with water while it is plugged in, as it may cause an electric shock.

Do not clean the refrigerator with benzene, thinner or car detergent. These substances can cause a fire.

CHANGING THE INTERIOR LIGHTS

WARNING

- Pull the power plug out of the socket before changing the interior light of the refrigerator.
- Otherwise, there is a risk of electric shock. If you experience difficulty changing the light, contact a Samsung service center.

Changing the LED Type Lighting

CAUTION

Do not disassemble or replace the LED type Lighting.

If you need to change the LED Type Lighting, contact a Samsung service center.

CHANGING THE WATER FILTER

WARNING

To reduce risk of water damage to your property DO NOT use generic brands of water filters in your SAMSUNG Refrigerator.

USE ONLY SAMSUNG BRAND WATER FILTERS. SAMSUNG is not legally responsible for any damage, including, but not limited to, property damage caused by water leakage from the use of a generic water filter.

SAMSUNG Refrigerators are designed to work ONLY WITH SAMSUNG Water Filter.

The “Filter Indicator” red LED light lets you know when it is time to change your water filter cartridge. To give you preparation time to get a new filter, the red light will come on just before the capacity of the current filter runs out.

Changing the filter on time provides you with the freshest, cleanest water from your fridge.

To make changing the water filter easier, you may want to shut off the water supply, and then drain any water remaining in the water line by pressing a glass against the water dispenser pad.

1. Remove the new water filter from its box and put a month indicator sticker on the filter as shown. Place a sticker on the filter with a date six months in the future. For example, if you are replacing the water filter in March, put the “SEP” (September) sticker on the filter to remind you to replace in September. Normal filter life is about 6 months.
2. Remove the old filter from the filter housing, and then remove the new filter’s protective cap.
3. Position the new filter, and then inset it into the filter housing.

Slowly turn the water filter clockwise to align the indicator mark on the filter with lock indicator on the filter housing.

Make sure to align the water filter label mark with the center of the lock indicator as illustrated above, right.

Do not over-tighten.

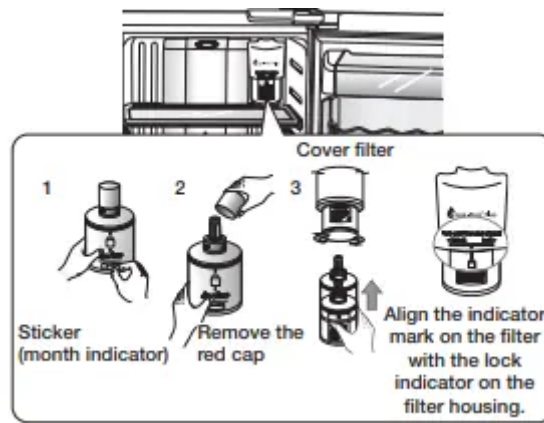

4. Once you have completed this process, hold the “Energy Saver” simultaneously for 3 seconds to reset the filter indicator.

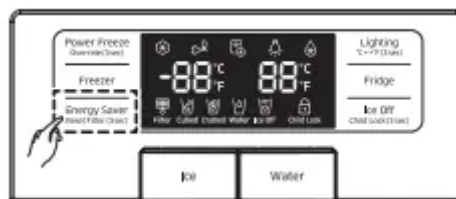

5. Turn on the water supply if you turned it off.

6. Flush 3 gallons of water through filter before drinking or using the water from the refrigerator.

This should take about 6 minutes.

To flush, press the Water button, and then press a large glass or cup against the water dispenser lever.

Fill the glass, empty it into the kitchen sink after it is filled, and then repeat. Make sure that water flows clearly again before drinking.

A newly installed water filter cartridge may cause water to briefly spurt from the water dispenser.

This is caused by air getting into the line. It should pose no problem to operation.

USING THE DOORS

The refrigerator doors are equipped with a door opening and closing feature that ensures that the doors close all the way and are securely sealed. After opening beyond a certain point, the door will “catch” and remain open. When the door is open short of the catch that allows it to stay open, it will close automatically.

USING THE ICE MAKER

- To Remove the Ice Bucket.

- Hold the handle as shown in figure1.
- Lift up and pull the Bucket out slowly.
- Take out Ice Bucket out slowly to prevent damage.
- After reinstalling the ice bucket, select the ICE mode.



Figure 1

- Normal Operation

- Any sounds you hear when the ice maker dumps ice into the bucket are part of normal operation.
- Ice may clump in the bucket if you do not dispense ice for long periods of time. If this occurs, remove all the ice and empty the bucket.
- If ice does not come out, check for any ice stuck in the chute and remove it.
- The first batch of ice cubes after installation may be small because air has entered the water line. Any air will be purged during normal use.



CAUTION

- When ICE OFF blinks on the display panel, reinsert the ice bucket and/or make sure it's installed properly.
- When the door is open, the Ice and water dispenser do not work.
- If you close the door hard, it may cause water to spill over the ice maker.
- To prevent the ice bucket from dropping, use both hands when removing it.

- To prevent injury, be sure to clean up any ice or water that may have dropped on the floor.
- Do not let the children hang on the ice dispenser or on the bucket. They may get hurt.
- Be sure not to put your hand or any object into the ice chute. It may cause personal injury or damage mechanical parts.
- Use care when storing food in plastic bags in the freezer.

Incorrectly stored bags can get caught in the ice bucket's Auger Motor and prevent the refrigerator from dispensing ice or cause the freezer door to open unexpectedly.

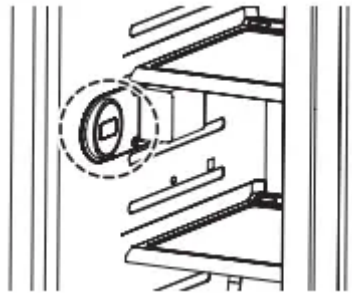

TROUBLESHOOTING

PROBLEM & SOLUTION

The refrigerator does not work at all or it does not chill sufficiently.

- Check that the power plug is properly connected.
- Is the temperature control on the display panel set to the correct temperature? Try setting it to a lower temperature.
- Is the refrigerator in direct sunlight or located too near a heat source?
- Is the back of the refrigerator too close to the wall and therefore keeping air from circulating?

The food in the fridge is frozen.

- Is the temperature control on the display panel set to the correct temperature? Try setting it to a warmer temperature.
- Is the temperature in the room very low?
- Did you store the food with a high water content in the coldest part of the fridge? You hear unusual noise or sounds.
- Check that the refrigerator is level and stable.
- Is the back of the refrigerator too close to the wall and therefore keeping air from circulating?

- Was anything dropped behind or under the refrigerator?
- If you hear a “ticking” sound from inside the refrigerator, this is normal. It occurs because various parts contract or expand in response to temperature changes in the refrigerator interior.

The front corners of the appliance are hot and condensation is occurring.

- Some heat is normal as anti-condensators are installed in the front corners of the refrigerator to prevent condensation.
- Is the refrigerator door ajar? Condensation can occur when you leave the door open for a long time.
- Water condensation in a drawer may occur if the drawer contains vegetables. The condensation will dissipate naturally as time passes.

Ice is not dispensing.

- Did you wait for 12 hours after installation of the water supply line before making ice?
- Is the water line connected and the shut-off valve open?
- Did you manually stop the ice making function? Make sure Ice is set to Cubed or Crushed.
- Are there any ice clumps in the ice maker bucket? Remove them.
- Is the freezer temperature too warm? Try setting the freezer temperature lower. You can hear water bubbling in the refrigerator.
- This is normal. The bubbling comes from the refrigerant coolant liquid circulating through the refrigerator.

There is a bad smell in the refrigerator.

- Has a food item spoiled?
- Make sure that strong smelling food (for example, fish) is wrapped so that it is airtight.
- Clean out your freezer periodically and throw away any spoiled or suspect food.

Frost forms on the walls of the freezer.

- Is the air vent blocked? Remove any obstructions so air can circulate freely.
- Allow sufficient space between the foods stored for efficient air circulation.
- Is the freezer door closed properly?

The water dispenser is not functioning.

- Is the water line connected and the shut-off valve open?
- Has the water supply line tubing been crushed or kinked? Make sure the tubing is free and clear of any obstruction.

- Is the water tank frozen because the refrigerator temperature is too low? Try selecting a warmer setting on the main display panel.

What Do I Need to Use the E-Smart and Smart Grid functions?

- To use the Smart Grid (Demand Response) and E-Smart function on your Refrigerator, you need the following devices and apps:

- Devices: 1) Wireless Router, 2) Samsung E-Smart Refrigerator, 3) Smartphone (Recommended: Galaxy S4, Galaxy Note3/ Android OS Jelly bean)

- Applications: 1) "Samsung E-Smart App" from the Google Play Store or Samsung Apps.

You also need to:

- Connect the Refrigerator and the Smartphone to the same Wi-Fi network in your home.
- Install and run Samsung E-Smart App on your Smartphone (to use the Samsung E-Smart function).
- In addition, to use the Smart Grid (Demand Response) function, you must Register for the service with your electric company.

The company must have an EMS (Energy Management System) that supports SEP (Smart Energy profile).

Why isn't the E-Smart function working normally?

- Confirm that the router in your home and the Internet are working properly.
 - Connect a Smartphone to the router (AP, Access Point), and then confirm that you can browse the Internet on the phone.
- Confirm that refrigerator is connected to the AP.
 - Check the E-Smart icon on the PANEL of refrigerator. If the refrigerator is connected, the icon will be on.
- Confirm that the refrigerator and Smart Phone are connected to the same router.

Why isn't the Delay Defrost Capability working normally?

- Confirm that the router in your home and the Internet are working properly.
 - Connect a Smartphone to the router (AP, Access Point), and then confirm that you can browse the Internet on the phone.
- Confirm that the area where you live is properly entered into the Smart phone App.
- Confirm that the Smart Grid function works correctly. (Check the PANEL. L3 and L4 should not be displayed on the PANEL.

Warning

This content is compiled from multiple sources and is provided for reference purposes only. It may not be complete or fully applicable to all situations. If you are unable to resolve your issue, please contact the product manufacturer or an authorized service provider for official support.

Document generated by [ManualsFile](#)

