

Setting up your dishwasher

CHECKING PARTS

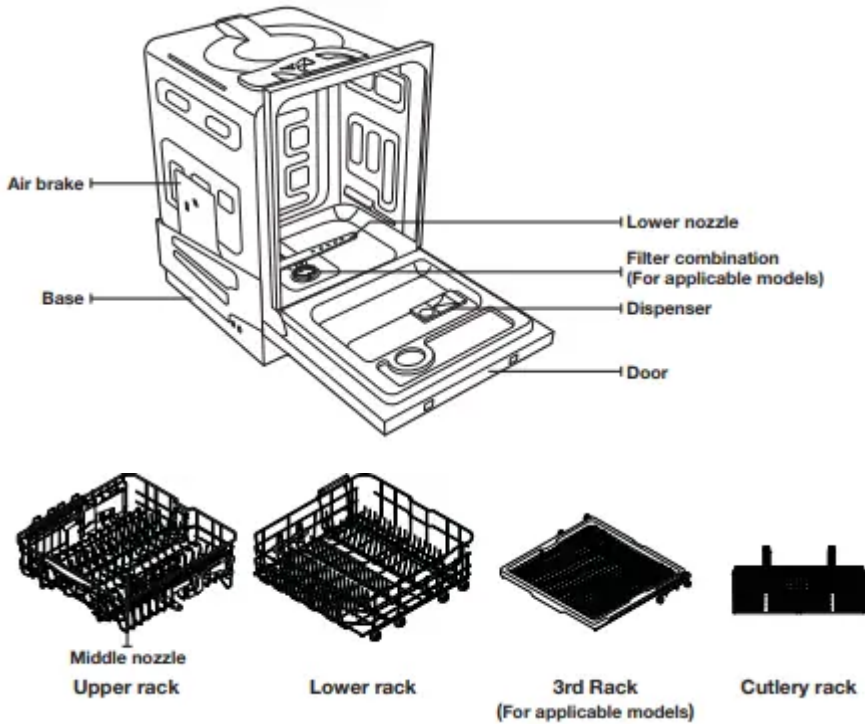





When your dishwasher has been unpacked, make sure you've received all the parts shown below. If your dishwasher was damaged during shipping, or if you do not have all the parts, contact Samsung Customer Service at 1-800-SAMSUNG (726-7864)

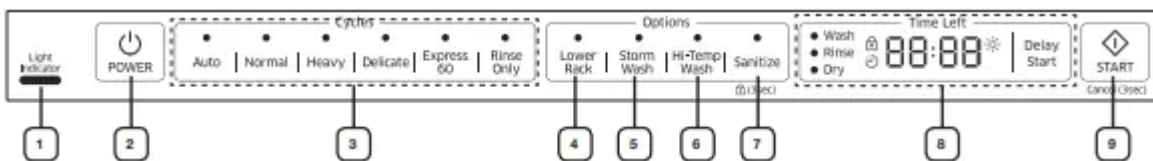

CONTROL PANEL

DW80K7050, DW80K5050 Series



1 Light indicator	Indicates that the product is operating.
2 Power	When you press the Power button, the entire display turns on and off, and then the light of the most recently finished cycle lights up. When the selected cycle is complete, the dishwasher powers off automatically.
3 Cycle Selector	Select the appropriate wash cycle depending on the soil level of your dishes. After you select a cycle, the Cycle On light for that cycle lights up.
4 Lower Rack	Select this option to wash a small load of dishes. We recommend that you place dishes in the lower rack when you use this feature.  When you select Lower Rack, the dishwasher will not wash dishes placed in the upper rack.
5 StormWash™	Use this option when you want to wash pots and pans, durable serving bowls, and other large, very dirty, hard to clean dishes. To use StormWash™, place the dishes face down in the marked StormWash™ area in the lower basket.  StormWash™ is not available with the Delicate and Rinse only cycles.
6 Hi-Temp Wash	Raises the main wash temperature to improve cleaning for loads containing tough, baked-on food.  Hi-Temp Wash is not available for the Delicate and Rinse only cycles.
7 Sanitize  (3sec) / (Control Lock)	The temperature rises to 163 °F (73 °C) in the final rinse cycle for high temperature sanitization. If you select the Sanitize option, the “Sanitize” lamp blinks when the water temperature reaches the sanitary temperature (over 155 °F (68 °C)), and then remains illuminated until the Sanitize option ends. When you press the Power button, the “Sanitize” lamp turns off.  Sanitize is not available for the Delicate and Rinse only cycles. The Normal Cycle with the Sanitize option selected is NSF certified.  The Sanitize feature operates in accordance with NSF/ANSI Standard 184 for Residential Dishwashers. Certified residential dishwashers are not intended for licensed food establishments. Only the DW80K7050 model dishwasher is NSF Certified.

	<p>Control Lock allows you to lock the buttons on the control panel so children cannot accidentally start the dishwasher by pressing the buttons on the panel.</p> <p>To lock and unlock the buttons on the control panel, hold the Sanitize button down for three (3) seconds when power is On.</p>
8 Delay Start (DISPLAY)	<p>Delay a cycle for up to 24 hours in one-hour increments. The hour displayed indicates the time at which the wash will be started.</p> <p>Displays wash information, Delay Start hours, and Error messages.</p> <p>If an trouble occurs during an operation, an check message is displayed with a warning sound. Refer to "Information codes" on page 30.</p>
9 Start	<p>To start a cycle, press the Start button before closing the door.</p> <p>To cancel the cycle, press and hold the Start button for 3 seconds or press the Power button to power off.</p>

 You can select options (Lower Rack, StormWash™, Hi-Temp Wash, Sanitize) before starting a cycle. If you change the cycle after selecting an option, the original cycle is reset.

 To prevent the touchpad from losing response sensitivity, follow these instructions:

- Touch the center of each keypad using one finger. Do not push.
- Clean the touch control's surface regularly with a soft, damp cloth.
- Be careful not to touch more than one touch key pad at a time, except as directed.

 When you pause a cycle by opening the door during operation, press the Start button before closing the door to continue the cycle.

Push door firmly closed within 3 seconds of pressing Start button.

If the door is not closed within 3 seconds, the cycle will not start.



CYCLE SELECTOR

DW80K7050, DW80K5050 Series

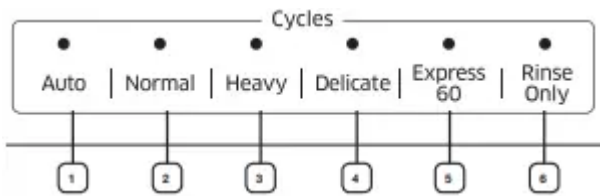

1 Auto	This cycle detects the level of soil and automatically initiates the optimal cycle after a few minutes of operation.
2 Normal	Use this cycle for normally soiled dinner dishes.
3 Heavy	Use this cycle for heavily soiled dishes and dishes with heavy soil.
4 Delicate	Use this cycle for normally soiled dishes or fragile items such as glasses.
5 Express 60	Use this cycle for lightly soiled dishes.
6 Rinse only	Use for rinsing dishes, glasses, and silverware that will not be washed right away. Do not use detergent.

Using your dishwasher

Touch controls

Touch controls allow you to operate the dishwasher easily.

- They are convenient to operate, requiring only a soft touch.
- Have a simple and stylish design.
- Are easy to clean.

If you have children or you want to clean the Control Interface, we recommend activating the Control Lock feature to lock the control buttons. See page 8.

- Children will not be able to accidentally start the dishwasher by touching the controls with this option selected.
- If a cycle is running, the buttons will not respond. (except the Power button)
- If dishwasher is off, only the Power button responds.

Setting Mode

The Setting Mode lets you change the dishwasher's Sound, Light indicator, and AutoRelease™ Dry settings. To enter the Setting mode, press the Delay Start + Sanitize buttons for 3 seconds

while the dishwasher is on. Press the Sanitize button to select a sub-setting menu and then press the Delay Start button to change a setting.

- Sound Setting: Press the Sanitize button until “U1” or “U0” is displayed. To change the setting, press the Delay Start button. “U0” turns the sound off for all cycles. “U1” turns the sound on. The dishwasher maintains the Sound Setting you have selected until you change it.
- Light indicator Setting: Press the Sanitize button until “B1” or “B0” is displayed. To change the setting, press the Delay Start button. “B0” turns the light off for all cycles. “B1” turns the light on.
- AutoRelease™ Dry setting: Press the Sanitize button until “A1” or “A0” is displayed. Press the Delay Start button to enable or disable AutoRelease™ Dry. “A0” disables AutoRelease™ Dry. “A1” activates AutoRelease™ Dry.
 - Once the door opens in the AutoRelease™ Dry mode, the door cannot be closed manually for the next 2 minutes.
 - The AutoRelease™ Dry mode will be disabled for the Rinse only cycle



 The door opens automatically 5 ~ 15 minutes before the cycle ends to improve drying performance.

 Changing the “AutoRelease™ Dry” setting can influence drying results. Select “A1” mode for better drying results. (“A1” is the default setting.)

 After a cycle is complete, the door automatically opens to let steam out. This is normal and not a product malfunction.

Delay start

When you select the Delay Start option, your dishwasher will:

- Start draining to remove remaining water at once (pre-drain).

Your dishwasher will operate the selected cycle when the delay time expires.



WARNING When using the dishwasher, try to arrange the dishes properly as described on page 16 to 19.

- You should remove food remains such as bones, fruit seeds, etc. and any other waste such as toothpicks, paper, etc. from the dishes as these may cause damage to the dishes, create noise, or cause the dishwasher to malfunction.
- Select the appropriate cycle depending on the level of soil and the type of dishes.

- Use only the proper amount of detergent and rinsing agent.



Do not wash the following items

- Acrylic or Aluminum items: Dishes with printed gold rim decoration may become discolored.
- Dishes treated with adhesive: Treated plastics, wood, ivory, copper, and tin may come loose.
- Plastics with a temperature tolerance less than 194 °F (90 °C): Thin plastics wash and dry poorly, and may be damaged due to elevated wash temperatures.
- Tin: Tin should be washed by hand and dried immediately as it may rust.
- Wooden utensils: Wooden items may crack.

ADJUSTING THE ANGLE OF THE PLATE SUPPORTS

You can adjust the angle of the tines in the upper rack to three different positions to match the size and shape of your dishes. To adjust the tines, grasp the handle at the back of the rack and push it left or right. See the illustration below.

In the lower rack, you can easily remove the plate support to make room for large items such as pots and pans. To remove the plate support, lift up the handles (A). To refit the plate support, align it so it is in place, and then push down on the handles (A). To fold down the fold-down tines on the lower rack, remove the rack from the dishwasher, turn the rack over, grasp the tine (B), and then adjust it backward. See the illustration below.

Upper rack



Lower rack

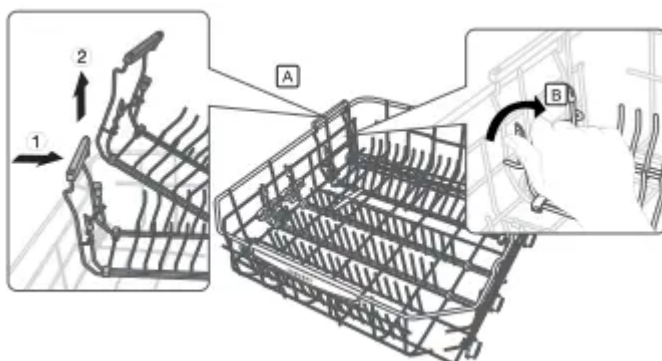

ADJUSTING THE HEIGHT OF THE UPPER RACK

You can adjust the height of the upper rack in your Samsung dishwasher so that the lower rack can accommodate larger sized dishes. With the upper rack set at the highest position, the lower rack can accommodate plates up to 12 in. (30 cm) in diameter and the upper rack can accommodate plates up to 8 in. (20 cm) in diameter.

DW80K7050, DW80K5050 Series

1. To lower the upper rack by 2 in. (5 cm), pull the adjustment handles located at the left and right sides of the upper rack and push the upper rack downwards slightly at the same time.
2. To raise the upper rack, just pull the upper rack upwards. The adjuster handle will latch and the upper rack will move to the high position.

Caution: We recommend adjusting the height of the upper rack before loading dishes into the rack. If you adjust the the rack after loading the dishes, you may damage the dishes.

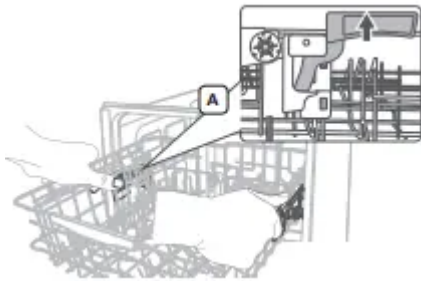

REMOVING THE UPPER RACK

Pull the upper rack towards the front and then remove it by lifting it up slightly and pulling it towards the front. See the illustrations below.

While the upper rack is removable, it must be installed for the dishwasher to operate properly.

Caution: If you attempt to operate the dishwasher without the rack, noise will occur and the dishwasher will perform poorly.

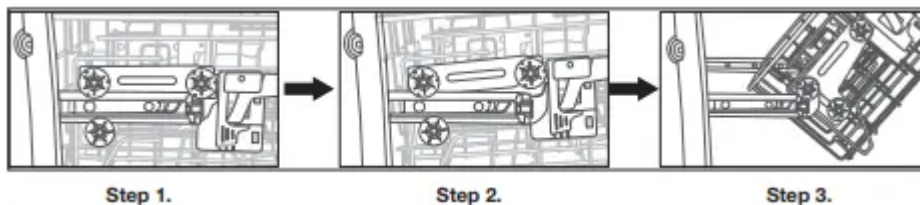

LOADING THE LOWER RACK

The lower rack has been especially designed for dinner dishes, soup bowls, plates, pots, lids, casserole dishes, and plates.

Load large items such as pans and pots into the dishwasher so their open sides face downwards. We recommend loading cups, stemware, and small plates into the upper rack.

See the recommended loading patterns below.



10 place setting



12 place setting

Loading the large items into the StormWash™ zone

You can load large items such as pots and pans into the StormWash™ Zone - identified by red guide lines - in the lower rack for more effective cleaning. When you select the StormWash™ option, an additional, powerful jet is activated and directed at items in the StormWash™ Zone. Make sure pot handles and other items do not interfere with the rotation of the nozzles.



LOADING THE UPPER RACK

The upper rack has been designed for small plates, mugs, glasses, and plastic items marked “dishwasher safe”. Load your plates into the dishwasher in two half rows, so that the front of each plate faces the back of the plate in front of it, and the open sides of the plates at the center of the dishwasher face each other.

See the illustrations below.

Make sure the loaded dishes do not interfere with the rotation of the nozzle which is located at the bottom of the upper rack. (Check this by rotating the nozzle by hand.)

When loading dishes, pull the upper rack out sufficiently so you can load it without striking the counter above.

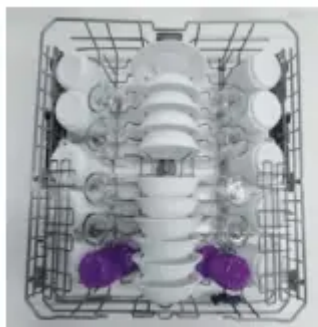

10 place setting

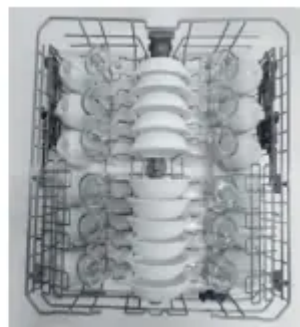

12 place setting

Using the glass support

You can load cups or glasses onto the glass support. This is also very convenient for washing wine glasses. Hang your wine glasses onto the pegs of the glass support. You can fold the glass support back when it is not being used.



DW80K7050 Series



DW80K5050 Series

USING THE CUTLERY RACK

The cutlery rack consists of two compartments.

You can place each knife, spoon, or fork separately into the spoon stands in the basket's covers to prevent chipping and discoloration.

You can use the cutlery rack with the cover open. Refer to the illustration to the right.

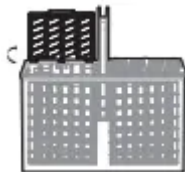

Left



Right

10 place setting



Left



Right

12 place setting

The spoon stands as seen from above with the suggested placement of cutlery items. Match the numbers in the diagram to the numbers in the list of cutlery items below.

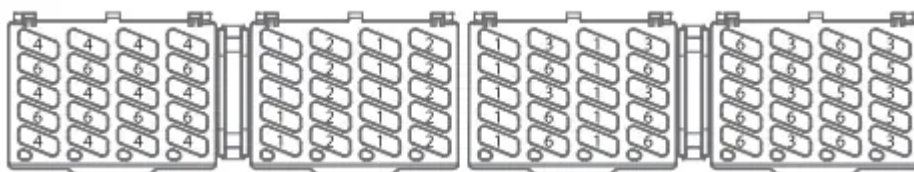

 DO NOT let any item extend through the bottom.

- 1 Forks
- 2 Tea spoons
- 3 Dinner spoons
- 4 Knives
- 5 Serving spoons and Serving forks
- 6 Remaining items

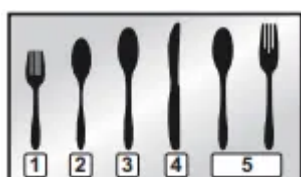

USING THE 3RD (CUTLERY) RACK (FOR APPLICABLE MODELS)

Loading the cutlery rack



< Place items randomly or regularly >

In addition to the standard cutlery basket in the lower rack, some models come with a cutlery rack.

The cutlery rack is best suited for flatware and cooking or serving utensils. You can place cutlery and utensils randomly or regularly on the cutlery rack.

Heavily soiled utensils or items with baked on foods should be placed in the lower cutlery basket for the most effective cleaning.

Removing the Cutlery Rack

The entire cutlery rack can be removed if more space is needed on the upper rack for larger items.

When loading the cutlery and utensils onto the cutlery rack, make sure they do not interfere with the top nozzle of the rack. If they interfere, remove the cutlery pad and try again.

USING DETERGENT

Filling the detergent dispenser

1. Open the detergent dispenser flap by pushing the detergent dispenser release catch.

 The flap is always open at the end of a dishwashing cycle.

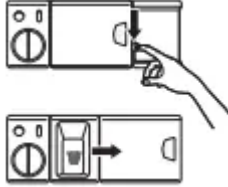

2. Add the recommended amount of detergent to the main wash detergent compartment.

3. Close the flap by sliding it to the left and then pressing it down.



4. For better cleaning result, especially if you have very dirt items, pour a small amount (about 1/2 of an ounce or 15 g) of detergent onto the door.

The additional detergent will activate during the pre-wash phase.



The cover opens automatically to dispense the detergent during the wash.

CYCLE	AMOUNT OF DETERGENT	
	Main wash dispenser	Onto the door for pre-wash
Auto, Normal	3/4 oz (20 g)	1/3 oz (10 g)
Heavy, Express 60'	1 oz (30 g)	1/2 oz (15 g)
Delicate	3/4 oz (20 g)	1/5 oz (5 g)

 The numbers inside the dispenser refer to grams.

Filling the rinse aid reservoir

When the Rinse Refi II indicator lights up on the control panel, refi ll the reservoir with rinse aid.

Your dishwasher has been designed to use liquid rinse aid only.

Using a powdered rinse aid will clog the reservoir opening and cause the dishwasher to malfunction.

Rinse aid improves the drying performance of the dishwasher.

Caution: Do not add regular detergent to the rinse aid reservoir.

1. Remove the rinse aid reservoir cap by rotating it counterclockwise.

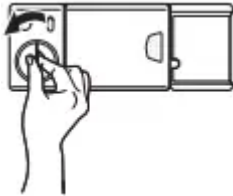

2. Fill the rinse aid reservoir with rinse aid.

 Use the viewing port when filling the rinse aid reservoir.

Caution: Do not fill the reservoir above the full level indicator. Excess rinse aid can overflow during the wash cycle.

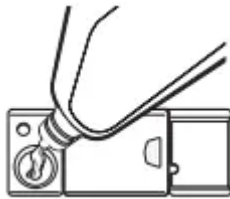

3. Turn the rinse aid indicator dial to a number between 1 and 6. The higher the number, the more rinse aid the dishwasher uses. If you are unable to rotate the rinse aid dial easily, try using a coin.

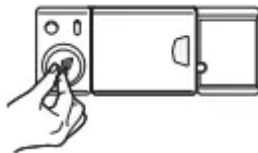

4. Close the rinse aid reservoir cap by rotating it clockwise.

Cleaning and maintaining your dishwasher

CLEANING THE EXTERIOR

It's best to clean spills on the outside of your dishwasher as they occur. Use a soft, damp cloth on the control panel to gently wipe away spills and dust. Do not use benzene, wax, thinner, chlorine bleach, or alcohol. These materials may discolor the inner walls and cause stains. Do not clean the dishwasher by sprinkling water over it and avoid letting water come into contact with any of the electrical parts.

If your dishwasher has a stainless steel door panel, you can clean it with a stainless steel cleaner for Home Appliances or a similar product using a clean, soft cloth.

CLEANING THE INTERIOR

Clean the interior of your dishwasher periodically to remove any dirt or food particles. Wipe the inside of the dishwasher and the inner part of the door with a wet dishcloth. We recommend filling the detergent dispenser with dish detergent, and then running the dishwasher empty periodically using either the Normal or Express 60 cycle with the sanitize option. This will keep your dishwasher clean.

If white spots and odor are still present in your dishwasher, run the Normal cycle with the dishwasher empty and without detergent until it finishes. Then, interrupt the cycle and put an 8 ounce cup of white vinegar into the lower basket. Close the dishwasher and let the cycle finish.

Caution: Do not remove the tub front seal (the long rubber seal enclosing the opening of the dishwasher).

CLEANING THE FILTERS (DW80K7050 SERIES)

1. Turn off the dishwasher.



2. Rotate the filter insert counterclockwise to unfasten and then detach the filter insert.



3. Remove the fine filter (flat, rectangular).



4. Remove any dirt or other remains from the filters, and then rinse them under running water.

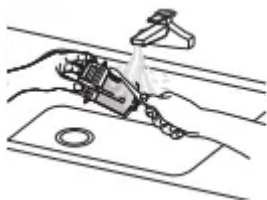

5. Reassemble the filters in the reverse order of the disassembly, replace the filter insert, and rotate clockwise to the close arrow.

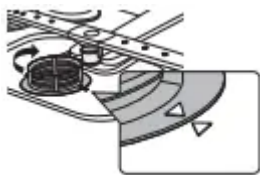

Caution: If the filter insert is not closed properly, its performance will be decreased.

CLEANING THE NOZZLES

If your dishwasher does not seem to be cleaning adequately or the nozzles seem clogged, you can clean each of the nozzles. When removing the nozzles, take care as they may break.

Lower nozzle

1. Check whether the nozzle holes are clogged by food particles.
2. If cleaning is needed, remove the nozzle by pulling it upwards.
3. Clean the nozzle, and then push it back into place.
4. Check whether the nozzle is engaged correctly by rotating it by hand.

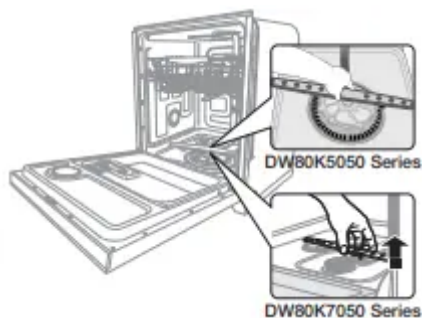

Middle nozzle

1. Pull the upper rack towards the front and remove it.
2. Check whether the nozzle holes are clogged by food particles.
3. If cleaning is needed, remove the nozzle.
4. To remove the nozzle, unfasten and remove the nut, and then remove the nozzle.
5. Clean the nozzle, re-insert it, and fasten the nut.
6. When fastening the nut, turn it firmly by hand.
7. Check whether the nozzle is engaged correctly by rotating it by hand.



Upper nozzle

1. Check whether the nozzle holes are clogged by food particles.
2. If cleaning is needed, remove the nozzle.
3. To remove the nozzle, pull out the upper rack first, unfasten the nozzle cap by turning it counterclockwise, and then remove the upper nozzle.
4. Clean the nozzle, re-insert it, and then fasten the nozzle cap to the nozzle by turning the cap clockwise.
5. Check whether the nozzle is engaged correctly by rotating it by hand.

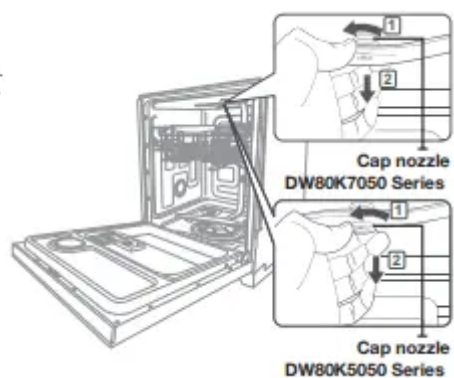

Troubleshooting

CHECK THESE POINTS IF YOUR DISHWASHER...

PROBLEM	POSSIBLE CAUSE	SOLUTION
Will not start.	The door is not closed completely	Check if the door is latched and closed completely.
	No cycle is selected.	Select a proper cycle.
	The power cable is not connected.	Connect the power cable properly.
	The water supply does not work.	Check if the water supply valve is open.
	The Control Panel is locked.	Unlock the child lock, (See page 8.)
	A circuit breaker is open.	Reset the circuit breaker
It's taking too long with an operation or cycle.	Cold water is being supplied.	Check if the water supply line is connected to a hot water supply. (Additional time is required to heat cold water.)
There are food particles remaining on dishes. (Not cleaning properly.)	You selected an inappropriate cycle.	Select a cycle according to the number and soil level of the dishes, as directed in this manual.
	The water temperature is low.	Connect the water supply line to a hot water supply. For best performance, the temperature of the supplied water should be 120 °F (49 °C).
	Low water pressure.	The water pressure should be between 20 and 120 psi (140 - 830 kPa).
	The water is too hard.	Use high-quality, fresh detergent with rinse aid.
	Dishwasher detergent was not used.	Use automatic dishwasher detergent. We recommend a powder or gel type dishwasher detergent.

	<p>Detergent remains in the dispenser.</p> 	<p>Make sure large items such as cookie sheets, cutting boards, or containers, etc. are not blocking the detergent dispenser and preventing it from opening properly.</p> <p>Rearrange the dishes so they do not interfere with detergent dispenser operation.</p>
	<p>There is no rinse aid.</p>	<p>Check the dispenser and add rinse aid.</p> <p>Use liquid type rinse aid.</p>
	<p>A nozzle is clogged.</p>	<p>Clean the nozzle. See page 23.</p>
	<p>The dishes are improperly loaded. Too many dishes have been loaded.</p>	<p>Rearrange the dishes so they do not interfere with nozzle rotation and detergent dispenser operation.</p> <p>Load only an appropriate number of dishes.</p> <p>Load your dishes as recommended. (See page 16.)</p>
<p>Leaves glasses with a dim polish.</p>	<p>The water supplied is soft and too much detergent was used.</p>	<p>Underload the dishwasher and use a rinse aid to minimize this.</p>
	<p>Aluminum dishes were included in the wash load.</p>	<p>Remove the marks on the dishes using a low sensitivity cleaner</p>
<p>Leaves a yellow or brown film on the inside of the dishwasher.</p>	<p>This is caused by coffee and tea soils.</p>	<p>Remove the soils using a spot cleaner.</p>
<p>Does not dry dishes well.</p>	<p>There is no rinse aid in the dispenser.</p>	<p>Check the dispenser and add rinse aid.</p> <p>Use a liquid type rinse aid.</p>
	<p>The temperature of the water is low when the dishwasher is running.</p>	<p>Connect the water supply line to a hot water supply.</p> <p>Use rinse aid with the Sanitize option.</p>

	Too many dishes have been loaded.	Proper loading of items can affect drying. Load your dishes as recommended. (See page 16.)
	Glasses and cups with concave bottoms hold water. This water may spill onto other items when unloading.	After the cycle finishes, empty the lower rack first and then the upper rack. This will prevent water from dripping from the upper rack onto the dishes in the lower rack.
	AutoRelease™ Dry mode is not in use.	Activate the AutoRelease™ Dry mode. (See page 12.)
Has a bad odor.	Water was left over from an incomplete cycle.	Insert detergent without loading dishes, and run the Normal cycle to clean the dishwasher
	The Drain Hose is obstructed.	Contact a qualified service technician to remove any obstruction from the drain hose.
	The dishwasher is not used daily or soiled dishes are left in unit too long.	With the dishwasher empty and no detergent, place a glass with 8 ounces of vinegar upright into the lower rack, and then run a Normal cycle.
Is too noisy.	Sound is generated when the dispenser cover is open and the drain pump is operating in an early stage.	This is normal operation.
	The dishwasher is not level.	Ensure the dishwasher is level.
	Foreign material (a screw, a plastic piece) is in the pump chamber.	Contact a qualified service technician to remove foreign material from the pump chamber.
	There is a 'chopping' sound because a nozzle is bumping against the dishes.	Rearrange the dishes.
Does not have a smoothly rotating nozzle.	The nozzle hole is clogged with food particles.	Clean the nozzle hole. See page 23.

	The nozzle is blocked by a dish or pot and cannot rotate.	After placing the dishes into the racks, rotate the nozzles by hand to check whether any of the dishes interfere with them.
Water won't pump out of the dishwasher.	The drain is clogged.	Contact a qualified service technician to remove any obstruction from the drain hose and check the drain pump operation.
Has a bent upper rack after loading dishes.	The dishes are not loaded properly.	Load your dishes as recommended. (See page 16.)
Cannot close the door.	AutoRelease™ Dry mode is in operation. 	Once the door opens in the AutoRelease™ Dry mode, the door cannot be closed manually for the next 2 minutes. You may close the door after 2 minutes.

INFORMATION CODES

The Control Panel displays information codes to help you understand what is occurring with your dishwasher.

Code	Action
OC	<p>Over-level water check</p> <ul style="list-style-type: none"> • Functional check. Close the water supply valve and go to your house circuit breaker panel, set the dishwasher's circuit breaker switch to off , and then contact an authorized Samsung service center.
LC	<p>Leakage check</p> <ul style="list-style-type: none"> • If a water supply valve connection leak occurs, close the water supply valve and go to your house circuit breaker panel, set the dishwasher's circuit breaker switch to off, and then contact the installer to fix. <p>If the problem continues, contact an authorized Samsung service center.</p>
4C	<p>Water supply check</p> <ul style="list-style-type: none"> • Check if the water supply valve is closed, the water supply is suspended, or the water inlet valve or line is frozen or clogged by foreign particles. If the problem continues, close the water supply valve, and then contact an authorized Samsung service center.
5C	<p>Drain check</p> <ul style="list-style-type: none"> • After closing the water supply valve, check whether the drain hose is clogged or folded. Also, check whether drain hole inside sump is clogged. <p>If the problem continues, contact an authorized Samsung service center.</p>
HC	<p>High temperature heating check</p> <ul style="list-style-type: none"> • The product ensure that the temperature for hot water line is not too high and adjusts to appropriate temperature (120 °F (49 °C) - 149 °F (65 °C)) automatically. If the problem continues, go to your house circuit breaker panel, set the dishwasher's circuit breaker switch to off , and then contact an authorized Samsung service center.
3C	<p>Pump operation check</p> <ul style="list-style-type: none"> • Functional check. Turn off the dishwasher and try to start it again. <p>If the problem continues, contact an authorized Samsung service center.</p>

For any codes not listed above, call 1-800-SAMSUNG (726-7864)



Warning

This content is compiled from multiple sources and is provided for reference purposes only. It may not be complete or fully applicable to all situations. If you are unable to resolve your issue, please contact the product manufacturer or an authorized service provider for official support.

Document generated by [ManualsFile](#)