

## Product Description

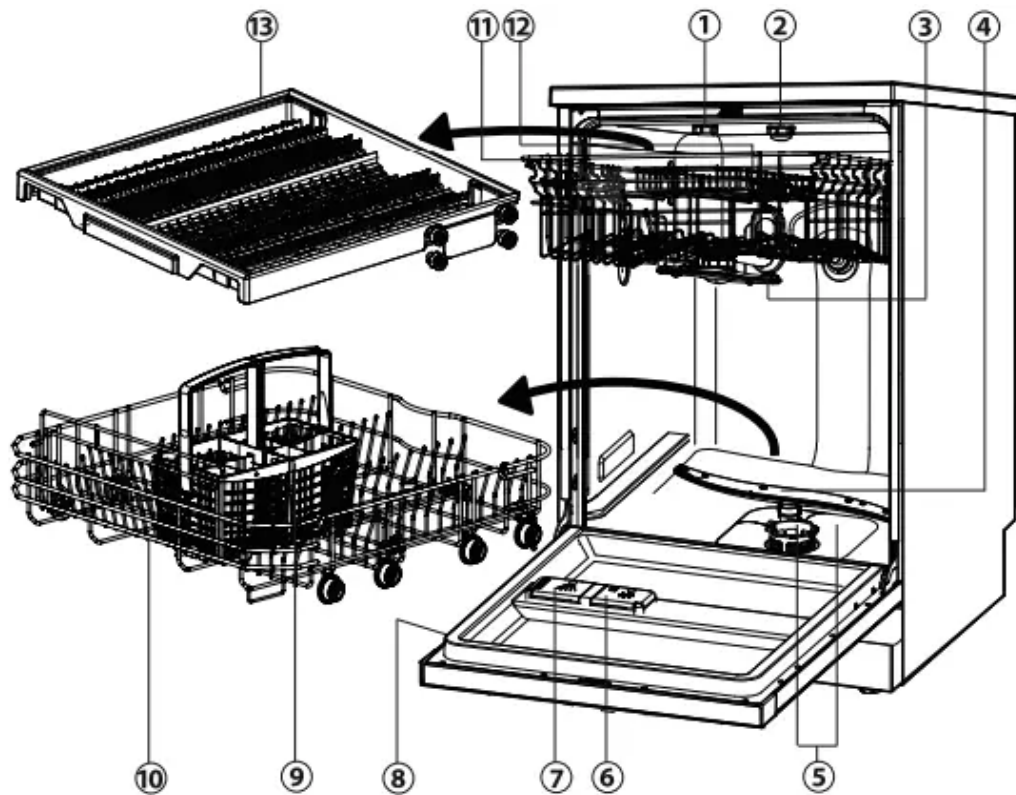

1. Thermo dry 1)
2. Top spray 2)
3. Upper spray arm
4. Lower spray arm
5. Filters
6. Rinse aid dispenser
7. Detergent dispenser
8. Rating label
9. Cutlery basket 3)
10. Lower basket
11. Upper basket
12. Knife rack
13. The third basket 4)

### Accessories

Check the accessories and literature in accordance with this list:



1), 2) Applicable to models HDW14G2, HDW15G2P and HDW15G3.

3) Applicable to models HDW13G1 and HDW14G2.

4) Applicable to models HDW15G2P and HDW15G3.

5) Applicable to models HDW13G1, HDW14G2 and HDW15G2P.

## Control Panel

HDW13G1/HDW14G2/HDW15G2P :

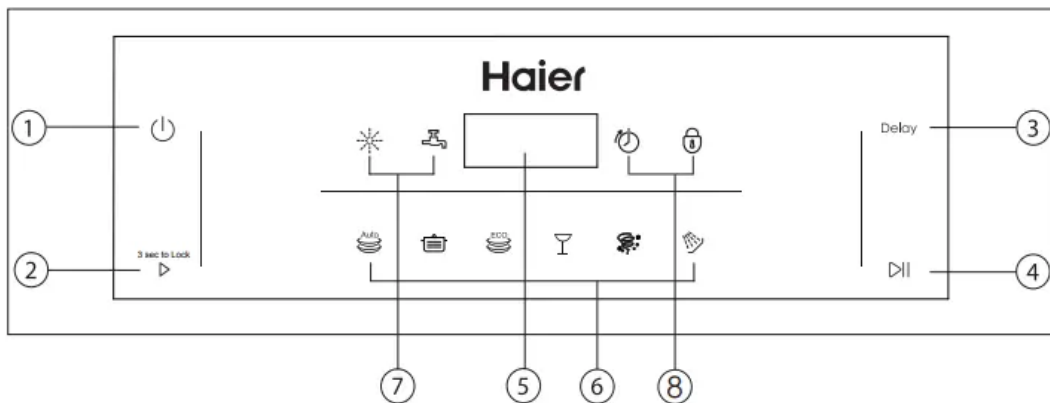

1. ON / OFF button 

2. PROGRAMME SELECT button 

3. START DELAY button 

4. START / PAUSE button 

5. Time & Info Display

6. Programme Indicators

7. Deficit Indicators

Rinse aid indicator 

Water tap indicator 

8. Option Indication

Delay start indicator 

Child Lock indicator 

### HDW15G3 :

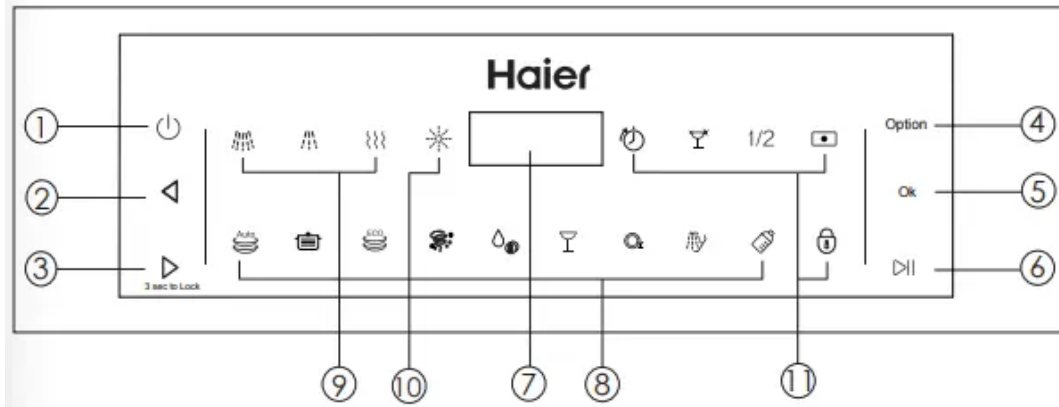

1. ON / OFF button 
2. PROGRAMME SELECT Left button 
3. PROGRAMME SELECT Right button 
4. Option SELECT button
5. OK button
6. START / PAUSE button 
7. Time & Info Display
8. Programme Indicators
9. Status Indication
10. Deficit Indication
11. Option Indication

### Time & Info display

During any selection the display shows by flashing related information like

- Programme cycle time
- Programme start delay time
- Error codes and service information

After start of an operation it displays without flashing:

- Remaining time in hours of a delayed programme starts, e.g. **24h**
- Remaining programme cycle time in hours + minutes, e.g. **1:59**

While running it may vary due to local conditions and daily working load.

## Deficit Indicators



If the indicator lights up: Rinse aid is empty! This indicator is off while the programme operates.



If the indicator lights up: The appliance does not fill with water.

Check section: "TROUBLESHOOTING"

## Status Indicators

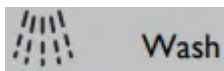

If the indicator lights up: the Dishwasher is washing.



If the indicator lights up: the Dishwasher is rinse washing.



If the indicator lights up: the Dishwasher is drying.

## Option Indication

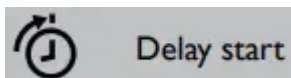

You can delay the start of a programme in 1 hour steps up to 24 hours. Check the according paragraph under "Daily use".



To active or cancel Child lock, press and hold  until the Child lock indicator comes on

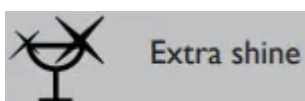

This option reduces spots on glassware and dinnerware. The option adds an extra intermediate rinse.

## 1/2 Half load





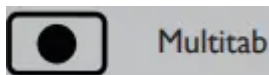

Use this option if you have only a few items to wash.

This will save water, energy and time. If you use powder detergent use a little less detergent than for a full load.





Activate this option only when you use the combi detergent tablets. This option decreases the flow of rinse aid and salt. Related indication. The programme duration can increase.

## Programmes

Programme	Type of food residue	Type of load
 Auto Auto 45–70°C <sup>1)</sup>	Light to heavy soil: Casseroles, sauces, potatoes, pasta, rice, roasted or fried food	Non-delicate: Dinnerware, cutlery, pots and pans
 Heavy 70°C	Heavy soil: Casseroles, sauces, potatoes, pasta, rice, roasted or fried food	Non-delicate: Dinnerware, cutlery, pots and pans
 ECO 50°C	Normal soil: Soups, eggs, sauces, potatoes, pasta, rice, roasted or fried food	Non-delicate: Dinnerware cutlery, glassware
 Glass-Auto	Light soil: Coffee, cake, milk, cold drinks, salad, sausages	Delicate: Glassware, dinnerware, cutlery
 Fast 30min <sup>2)</sup>	Fresh soil: Coffee, cake, milk, cold drinks, salad, sausages	Non-delicate: Dinnerware, cutlery, glassware
 Rinse <sup>3)</sup>	Dishes to be stored for a few days before washing	All: Dinnerware, cutlery, glassware, pots and pans

On some models :

 Saving	Light or fresh soil: Soups, eggs, sauces, potatoes, pasta, rice, roasted or fried food	Non-delicate: Dinnerware, cutlry
 Mix 90min	Mixed soil: Coffee, cake, milk, cold drinks, salad, sausages, Casseroles, sauces, potatoes, pasta, rice, roasted or fried food	Non-delicate: Dinnerware, cutlery, glassware pots and pans
 Hygiene	Hygiene soil: Casse oles sauces, potatoes, pasta, rice, roasted or fried food	Non-delicate: Dinnerwa cutle, pots and pans

1. The appliance senses the type of soil and the quantity of items in the baskets. It automatically adjusts the temperature and quantity of water, energy consumption and programme duration.
2. With this programme you can wash a load with fresh soil. It gives good washing results in a short time.
3. Use this programme to quickly rinse the dishes. This prevents the remaining food to bond on the dishes and bad odours to come out from the appliance. Do not use detergent with this programme!

## Before first Use

### First Steps

Remove all packaging materials, keep them out of childrens reach and dispose them in an environmentally friendly manner. There could be water residue inside the appliance due to quality checks in the factory. Perform the following steps:

1. Install the appliance.  
Refer to section INSTALLATION.
2. Only for use of Multitabs: Adjust the rinse aid setting.  
Refer to section DIFFERENT SETTINGS FOR RINSE AID.
3. Fill the rinse aid dispenser.  
Refer to section HOWTO FILL THE RINSE AID DISPENSER.
4. Open the water tap.
5. Start any wash programme (apart from 20 minutes programme) with detergent but no load to remove possible manufacturing residues.

## Activate / De-Activate the Buzzer

An acoustic signal informs about the end of a programme. This signal can be switched off.

Refer to section HOWTO ADJUST SETTINGS and select the **b**-setting:

- If the display shows **b0** the signal is switched off.
- If the display shows **b1** the signal is switched on.

## Different Settings for Rinse Aid

Rinse aid is added during the last rinsing phase to dry the dishes without streaks and stains.

### Detergent (e.g. powder, tabs, ...)

- requires separate rinse aid:

Factory default setting: **d6**. No settings are necessary.

The rinse aid is added from the rinse aid dispenser only.

### Detergent with multifunction (e.g. Multitabs)

- combine detergent and rinse aid:

The rinse aid setting should be adjusted to **d2**. Please use the setting instructions in section HOWTO ADJUST SETTINGS and select the **d**-setting.

The rinse aid is added from the rinse aid dispenser in addition to the multitabs rinse aid.

Setting **d1** cuts off the rinse aid dosage and the rinse aid indication. The higher the value for **d** the higher the dosage.

Usually the recommended setting performs well. In case of streaks, stains, shimmer etc.; refer to section TROUBLESHOOTING.

## How to fill the Rinse Aid Dispenser



**CAUTION!**

Only use rinse aid for dishwashers.



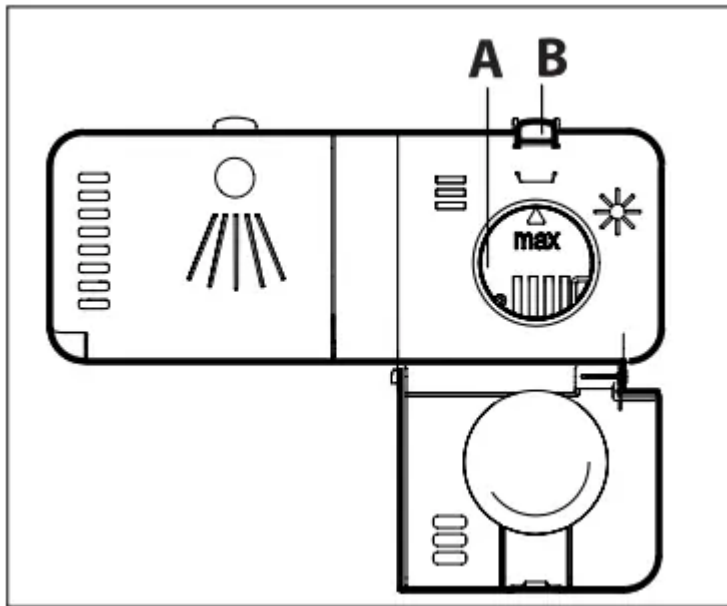

Other product can cause damage to the appliance!



1. Press the release button (B) to open the lid.
2. Fill the tank (A) up to the 'max' mark.
3. Remove any spilled rinse aid with an absorbent cloth. Overdosed or spilled rinse aid may cause problems creating foam
4. Close the lid. Make sure that the release button locks into position.



### How to Adjust Settings

To adjust the Rinse Aid level

1. The appliance is switched off.
2. Press and hold “ and **Delay**” about 3 seconds until (for HDW15G3, Press and hold “ and Option”): The display shows the current Rinse Aid setting (the default is *d6*). 
3. Press  (for HDW15G3, Press OK) to change the Rinse Aid setting in steps between *d1* (minimum dispense) and *d7* (maximum dispense).

To exit the Rinse Aid menu, press and hold 1 second .

### Activate / De-Activate the Buzzer

1. The appliance is switched off.
2. Press  and **Delay** hold and about 3 seconds until (for HDW15G3 , Press and hold “ and Option”): The display shows the current Rinse Aid setting.

3. Press **Delay** (for HDW15G3, press Option) to scroll to the buzzer menu.
4. The display will show **b0** (buzzer off) or **b1** (buzzer on).
5. Press **U** (for HDW15G3, press OK) to toggle between **b0** (buzzer off) or **b1** (buzzer on).
6. To exit ,press and hold 1 second **U**.

## Child lock

This feature disables all the buttons on the dishwasher. If any other buttons are pressed while Child lock is activated, the the Child lock indicator will flash for a few seconds.

1. To activate Child lock, press and hold **▷** that Child lock has been activated.
2. The display will remain on (if no programme has been started it will continue to flash while the control panel is locked).
3. To cancel Child lock, press and hold that **▷** Child lock has been cancelled.

## Daily Use

Please note that not all sales models comes with identical features and options. So pictures of that chapter are sometimes different to your dishwasher model. Explanations try only to point out basic model variants.

1. Load the baskets.
2. Open the water tap.
3. Press the ON/OFF button **U** to activate the appliance. If the rinse aid indicator is on, fill the rinse aid dispenser and reset the rinse aid indicator; refer to section HOW TO RESET THE RINSE AID IDNICATOR.
4. Add the detergent;refer to section DETERGENT.
5. Close the door.
6. Set the programme according to the type of load and how dirty the dishes, cups and cutlery are.
7. Maybe select a start delay time.
8. Press the START / PAUSE button **▷||** to start the programme.
9. After programme end close the water tap.
10. After programme end the appliance change to auto off. Unload the baskets.

## How to Reset Rinse Aid Indicator

The appliance is switched on.

The rinse aid indicator is on:

1. Always completely fill the rinse aid before starting the next wash cycle.
2. Press and hold the START/PAUSE button  until the indicators light up. The programme starts.

### Load the Baskets



With delicate glasses and porcelain make sure they are labelled dishwasher-proof.

Do not put in the appliance items made of wood, horn, aluminium, pewter and copper.

Do not put in the appliance items that can absorb water (sponges, household cloths).

- Only use the appliance to wash items that are dishwasher-safe.
- Remove remaining food from the items.
- Soften burned food on the items before washing.
- Put hollow items (cups, glasses and pans) with the opening down.
- Put items with deep hollows in a slanted position.
- Mix spoons with other cutlery to prevent them to bond together.
- Make sure that cutlery and dishes do not bond together and there is a gap between each item.
- Make sure that glasses do not touch other glasses.
- Put small items in the cutlery basket.
- Put light items in the upper basket. Make sure that the items do not move.
- Make sure that the spray arms can move freely before you start a programme.



If jingling noises are heard during a programme run: Check that the dishes and glassware have a firm position.

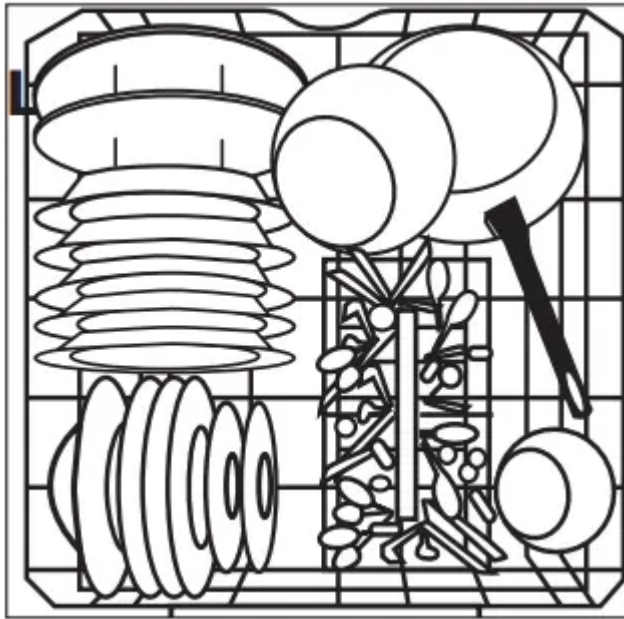

Place heavily soiled items (like pots and pans or dinner plates) in the bottom basket. The more powerful spray jet provides a better dishwashing result.

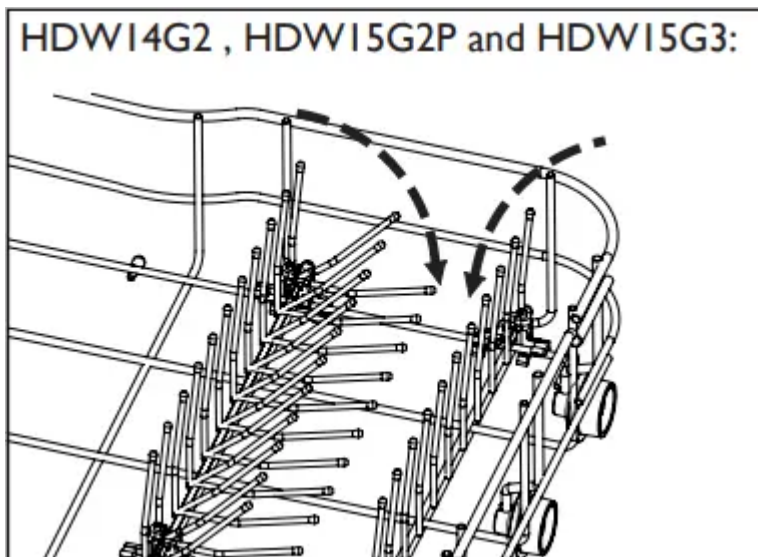

The lower basket has folding spikes. Fold down these spikes to improve arrangement of pots, pans and bowls.

### **Cutlery Basket**

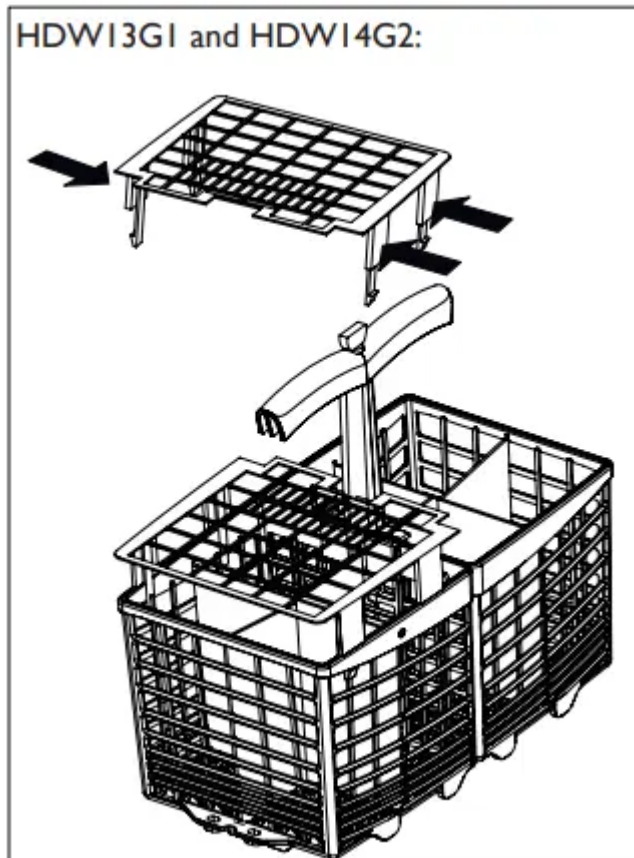

- Mix spoons with other cutlery to prevent them to bond together.
- Use the grid element in order to separate the cutlery.
- Place cutlery with the handles down for better washing results.
- If long items may block the spray arms find a horizontal positioning in the upper basket.

**CAUTION!**



Put sharp and pointed items with the blade pointing downward to keep them out of harms way

**Upper Basket and utensil tray**

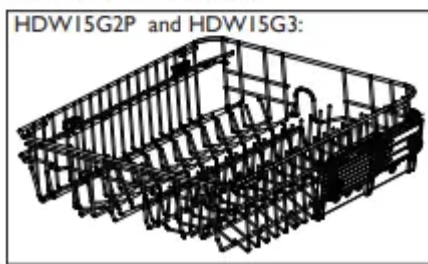
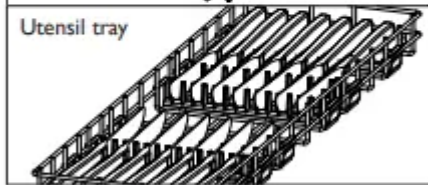
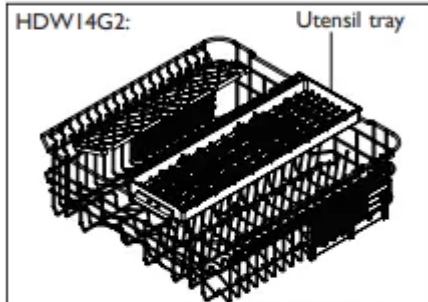
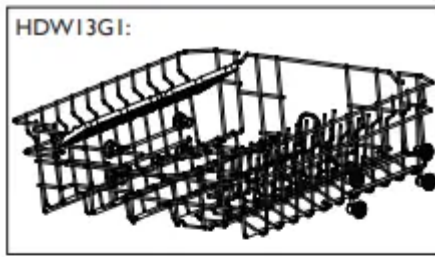

- The upper basket is designed to hold items like glasses, cups, saucers, plates, small bowls and shallow pans.
- Use the utensil tray to securely hold long or sharp items like knives, chopsticks, or ladles. Ensure that knife blades are facing down.
- Slide or remove the utensil tray if you need the space for other items below.
- You can adjust the height of the upper basket to create more space for tall items in the lower basket.
- For best washing results place the table knives in the knife rack.

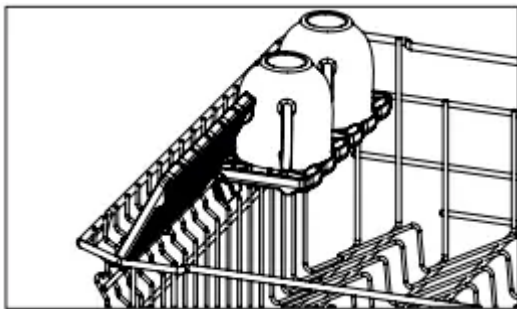

Place small items on the foldable cup holder.

## CAUTION!



Place sharp and pointed items with the blade pointing downward into the knife rack, to keep them out of harm's way.

## Detergent



Please use only a dedicated dishwasher detergent and follow the related instructions and dosage on its package.

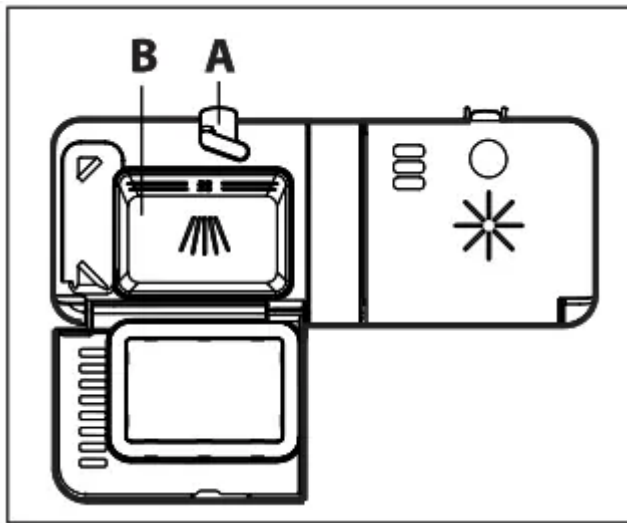

1. If the lid is closed press the release button (A) to open the lid.
2. Put any detergent into compartment (B).
3. If the programme has a pre-wash phase, put a small quantity of detergent on the inner part of the appliance door. Refer to section PROGRAMMES.
4. Close the lid. Make sure that the release button locks into position.

## Multitabs

These combi detergent tablets could include too different agents for water softening, rinse aid and other functions. The softener and rinse aid setting must be adjusted according to section BEFORE FIRST USE.

Usually the default setting performs well. If there are streaks, stains, shimmer etc., refer to section TROUBLESHOOTING and BEFORE FIRST USE.





Detergent tablets do not fully dissolve with short programmes. That may cause bad washing results and detergent residues.

If detergent without multifunction should be used again:

1. Save 3 to 5 tablets

2. Adjust the softener and rinse aid setting according to section BEFORE FIRST USE.
3. Use combi detergent tablets for the next 3 to 5 wash cycles.

## Start a Programme

1. Close the door.
2. Open the water tap.
3. Press the ON/OFF button .
4. Press sequentially the PROGRAMME SELECT button  until the required programme indicator lights up. Additionally the display flashes the programme run-time.
5. If desired select a start time for a delay start. Refer to section START A PROGRAMME WITH DELAY.
6. Press the START/PAUSE button  to activate the programme or the delay start.

The programme starts. The display acts now as countdown of the remaining run-time.



The appliance remembers the last programme you used. The next time the appliance will switch on, the appliance pre-selects the programme last used.

## Interrupt a Running Programme

To interrupt a programme run:

- Press the START/PAUSE button . In the display **P** is flashing. and/or
- Open the door. The display cycle time is flashing.

Press the START/PAUSE button  and/or close the door to continue the programme from the point of interruption. Longer breaks may cause bad cleaning results.

## Activate / Deactivate options

On some models, the combination of all options is possible with all programmes. You can set one option or combine all options.

1. Switch on the appliance.
2. Select a programme. The display shows the duration of the programme.
3. Press the option button. The display switches off. The first indicator of the options flashes.
4. Press the option button again and again until the indicator of the required option flashes.
5. Confirm with the OK button. OFF ( or ON) flashes in the display.
6. Press the option button to select ON (or OFF).
7. Confirm with the OK button. The option is activated (deactivated).

8. Repeat step 3 to 7 to activate more options.

9. Press the button to start the programme.

## Care and Cleaning

### Care and Cleaning the Filters

There are three filter ( A1, A2, B) to be checked and cleaned.

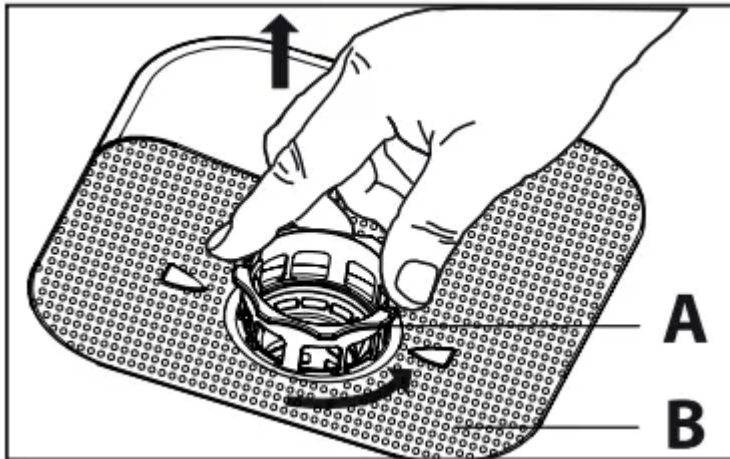

1. Turn the filter A anticlockwise and remove it.

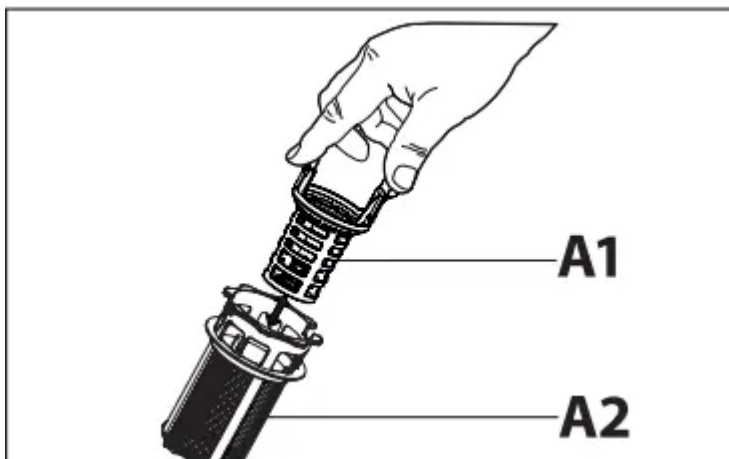

2. To disassemble the filter A press the latches and unplug A1 from A2.

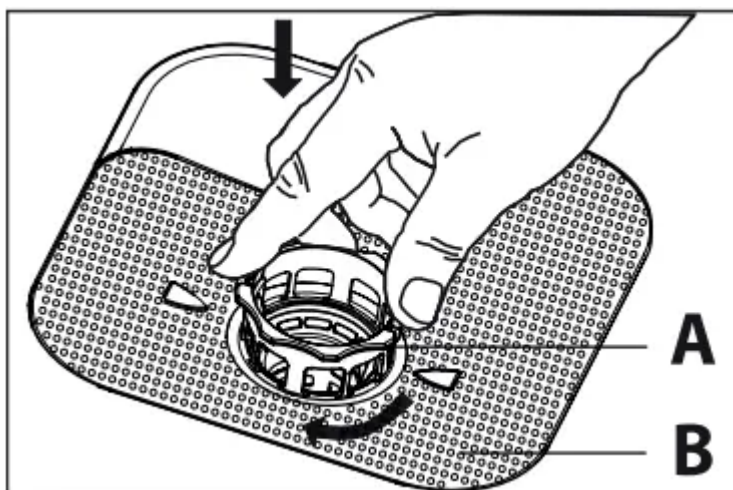

3. Remove the filter B.
4. Clean the filters with water.
5. Put the filter B to its initial position.
6. Assemble the filter A and put it into position in filter B. Turn it clockwise until it locks.



An incorrect assembly or position of the filters will cause bad washing results and possibly serious damage to the appliance.

If any filter is removed make sure that no solid object of any size is left beyond these filters!

### Care and Cleaning of the Spray Arms

Spray arms should be regularly inspected for dirt. If needed the spray arms could be removed.

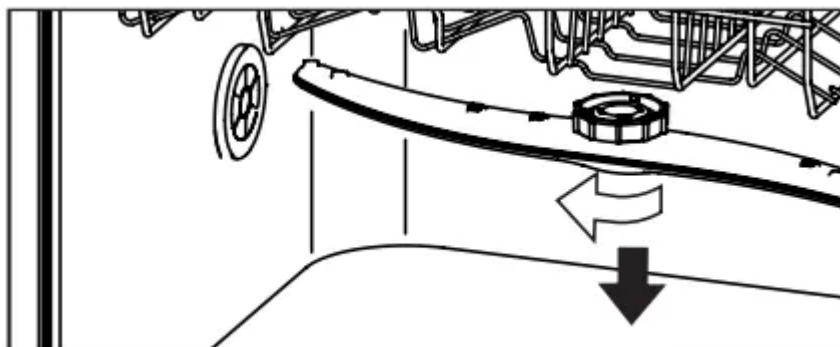

#### Upper spray arm

1. Turn bayonet socket to the left to remove spray arm.
2. Remove remaining parts of food remnants with a thin pointed object.
3. Flush with water and check all the holes are clear.
4. Turn bayonet socket clockwise to fasten spray arm.

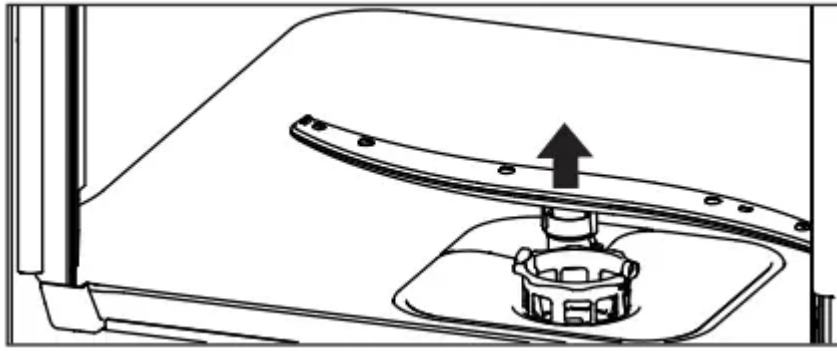

### Lower spray arm

1. Pull at the center to remove spray arm.
2. Remove remaining parts of food remnants with a thin pointed object.
3. Flush with water and check all the holes are clear.
4. Place spray arm at the center with a light push.

### External Cleaning



#### CAUTION!

Never clean the appliance with a steam cleaner.

Never use bleach or other chlorinated detergents.

- Clean the appliance with a damp soft cloth.
- Only use neutral detergents. Do not use abrasive products, abrasive cleaning pads or solvents.
- Clean the door seal with a damp soft cloth.

### Troubleshooting

Many occurring problems could be solved by yourself without specific expertise. In case of a problem please check all shown possibilities and follow below instructions before you contact an after sales service



#### CAUTION!

- Before maintenance. deactivate the appliance and disconnect the mains plug from the mains socket.
- Electrical equipment should be serviced only by qualified electrical experts. because improper repairs can cause considerable consequential damages.

### The appliance does not start or it stops during operation

<b>Problem</b>	<b>Possible cause</b>	<b>Possible solution</b>
The programme does not start.	Appliance door is open.	Close the appliance door.
	Delay start is set.	Refer to displayed time.
	Mains plug is not connected in the mains socket.	Connect the mains plug.
	Fuse in the house circuit is damaged.	Replace the fuse.
Rinse Aid Indicator  is lighted.	Rinse aid dispenser is empty.	Refill Rinse aid till full.
	Refill of rinse aid was not confirmed.	Press and hold the START/ PAUSE button for 1 sec after each refill.

### **Error codes on the display**

Problem	Possible cause	Possible solution
<p>Acoustic alarm, display shows ALARMCODE <b>E10</b> The appliance does not fill with water</p>	Water tap is closed.	<ul style="list-style-type: none"> <li>• Open the water tap.</li> </ul> <p><b>Note:</b> Whenever „Error 10“ is solved switch off the appliance and restart the programm.</p>
	Water inlet hose has a kink or a bend.	Make sure that the position of the hose is correct.
	In case of aqua-stop system: water protection is triggered; the marker (C) is red.	The hose must be replaced.
	Filter in the water inlet hose is clogged.	Clean the filter at the inlet hose connections at tap and the rear of the appliance.
	Water inlet is clogged.	Check water flow from tap.
	Water pressure is too low.	Contact your local water authority.
<p>Acoustic alarm, display shows ALARMCODE <b>E20</b> The appliance does not drain sufficiently.</p>	Filters are clogged	<ul style="list-style-type: none"> <li>• Scoop out as much water as possible.</li> <li>• Clean filters.</li> <li>• Continue programme by pressing the START/PAUSE button.</li> </ul>
	the drainage is blocked	<ul style="list-style-type: none"> <li>• Scoop out as much water as possible.</li> <li>• Make sure that drain water-connection and piping is correct and not blocked.</li> <li>• Continue programme by pressing the START/PAUSE button.</li> </ul>

		<ul style="list-style-type: none"> <li>• If the fault persists, contact customer care.</li> </ul>
<p>Acoustic alarm, display shows ALARMCODE Leak:The drain pump runs permanently!</p>	<p>Anti-flood device is on:</p> <ul style="list-style-type: none"> <li>• There are water leakages in the appliance.</li> <li>• The water inlet valve is open and blocked.</li> <li>• The drainage is blocked.</li> </ul>	<ol style="list-style-type: none"> <li>1. Close the water tap.</li> <li>2. Disconnect appliance from power supply.</li> <li>3. Contact Service.</li> </ol>

All other Alarmcodes:

1. Note Alarmcode
2. Contact Service ;refer to CUSTOMER SERVICE

**Washing Results are not satisfactory**



<b>Problem</b>	<b>Possible cause</b>	<b>Possible solution</b>
The dishes are not clean.	Filters are clogged.	Clean the filters.
	Filters are not correctly assembled and installed.	Make sure that the filters are correctly assembled and installed.
	Spray arms are clogged.	Remove remaining food remnants with a thin pointed object.
	Programme was not applicable for the type of load and food remnants.	Make sure that the programme is applicable for the type of load and food remnants.
	Incorrect position of the items in the baskets. Water could not wash all items.	Make sure that the position of the items in the baskets is correct and that the water can easily wash all items.
	Spray arms could not turn freely	Make sure that the position of the items in the baskets is correct and does not cause the blockage of the spray arms.
	No detergent or insufficient quality of detergent in the detergent dispenser.	Make sure that you add the correct quantity detergent in the dispenser before you start a programme.
	The wash cycle was interrupted by a long break.	Do not open the door or cut power supply during the wash cycle.
Whitish streaks, stains or bluish layers on glasses and dishes.	Released quantity of rinse aid is too much.	Decrease the released quantity of rinse aid. Refer to section DIFFERENT SETTINGS FOR RINSE AID.
	Quantity of detergent was too much.	Make sure that you add the correct quantity of detergent in the

		dispenser before you start a programme.
	Combi detergent tablets used with a short programme might not fully dissolve.	Select a longer programme when using combi detergent tablets.
Dry water drop stains on glasses and dishes.	Rinse aid dosage is too low..	Increase the released quantity of rinse aid. Refer to section DIFFERENT SETTINGS FOR RINSE AID.
	Quality of rinse aid or Multitab.	Cleaning product too old; change the product.
The dishes are wet.	<ul style="list-style-type: none"> <li>• Programme had no drying phase.</li> <li>• Programme had a low temperature drying phase.</li> </ul>	Open the door slightly and leave it ajar (about 100 mm) to help the drying process.
The dishes are wet and matt.	Rinse aid dispenser is empty.	Refill rinse aid into dispenser and reset the rinse aid indicator.
	Quality of rinse aid or Multitab.	Cleaning product too old; change the product.

### Warning

This content is compiled from multiple sources and is provided for reference purposes only. It may not be complete or fully applicable to all situations. If you are unable to resolve your issue, please contact the product manufacturer or an authorized service provider for official support.