

## USING THE FREEZER

### Temperature Control

For safe food storage, allow 4 hours for the freezer to cool down completely. The freezer will run continuously for the first several hours. Foods that are already frozen may be placed in the freezer after the first few hours of operation. Unfrozen food should NOT be placed in the freezer until it has operated for 4 hours. Allow several hours after each one-step adjustment for the freezer temperature to stabilize.

When loading the freezer, freeze only 3 pounds of fresh food per cubic foot of space at a time. Distribute packages evenly throughout the freezer. It is not necessary to turn the control knob to a colder setting while freezing food.

### Starting the Freezer with Electronic Control

1. If desired, clean the inside of the freezer with a mild solution of baking soda and water (see Care and Cleaning).
2. Connect cord to power outlet. The 7-segment display will come on and flash with the default setting temperature of 0°F, and the “High Temp” Alarm will be displayed on the electronic temperature control with an audible warning. Pressing “Alarm Reset” on the control will silence the alarm, and stop the flashing, but the “High Temp” LED will stay on until your freezer reaches a safe storage temperature.
3. Press “-” or “+” to reach desired temperature.
4. Press “+” and “-” buttons at the same time for 3 seconds to switch the display temperature unit between °F and °C.
5. Allow freezer to operate for at least four hours before placing food inside.

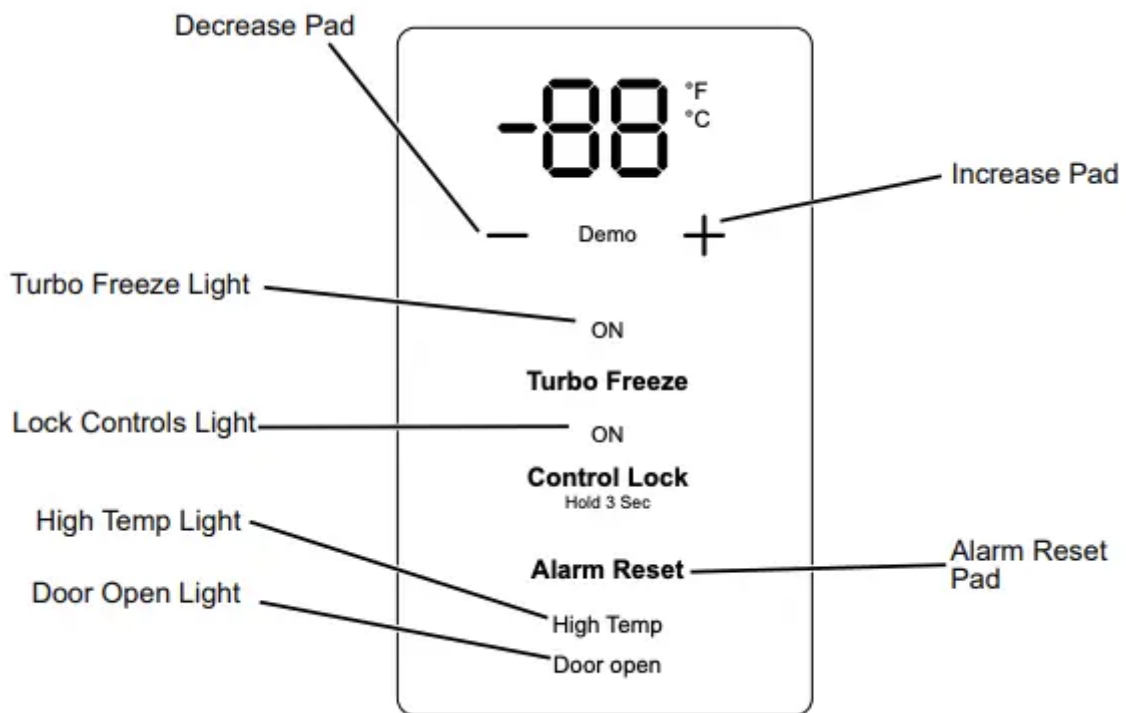
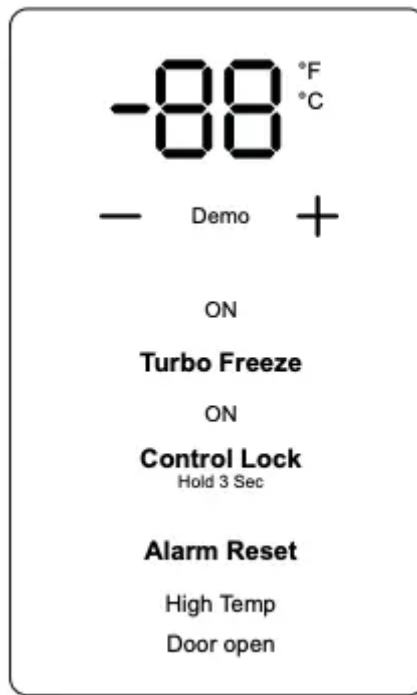

This electronic temperature control is located on the front of the freezer door. The temperature is factory-preset to provide satisfactory food storage temperatures. To adjust the temperature setting, press - to decrease temperatures and + to increase temperatures. Allow several hours for the temperature to stabilize between adjustments.

### High Temp Alarm

This electronic control has a high temperature alarm feature. An alarm will sound if the freezer temperature is high. To silence the alarm, press **Alarm Reset** on the control panel.



The **High Temp** will continue to be displayed on the control panel until set temperature has been restored. The alarm will sound again if the temperature is not restored and remains high in six hours.

### **Turbo Freeze**

To enable **Turbo Freeze**, press **Turbo Freeze** until Turbo Freeze **ON** light turns on. The unit will be in “Turbo Freeze” mode for 8 hours and the **ON** light for Turbo Freeze will stay illuminated. After the 8 hours is completed, **Turbo Freeze** turns off automatically. The **ON** light will be off to show that **Turbo Freeze** is off. To exit **Turbo Freeze** before the 8 hour automatic shutoff, press Turbo Freeze until **ON** light for Turbo Freeze is off.

### **Control Lock**

To lock the controls, press Control Lock and hold for 3 seconds until the **ON** light for Control Lock turns on.

To unlock, press and hold **Control Lock** for 3 seconds. The **ON** light for **Control Lock** turns off and the control panel will be unlocked. Control setting cannot be changed when the control is locked.

### **Power Fail**

If a power outage has caused the internal temperature to be high, the high temp alarm will sound and the temperature display will flash. Pressing **Alarm Reset** on the control will silence the alarm and stop the flashing, but **High Temp** LED will stay on until your freezer reaches a safe storage temperature.

If the internal temperature has been restored before you press Alarm Reset, the sound alarm will stop on its own, and the High Temp LED will go off automatically. The temperature display will continue flashing to remind you that a power outage has occurred. Press Alarm Reset to stop the flashing.

### **Door Open Alarm**

If your door has been left open for more than 2 minutes, the control panel will display **Door Open** and will sound an alarm until the door has been closed or Door Open is pressed on the control panel. If **Door Open** has been pressed but the door has not been closed, **Door Open** will continue to be displayed on the control panel until the door has been closed. If 10 minutes after **Door Open** has been pressed, the door is still open, the door open alarm will sound again.

### **C or F Setting**

To change between C° or F°, press and hold the - and + pads at the same time for 3 seconds.

### **Control Dormant**

The control settings are displayed at normal condition. Press and hold **Control Lock** and **Turbo Freeze** for 3 seconds. The electric control will enter into Dormant Mode and will not show the control settings. The control settings will be displayed for 30 seconds if one of the buttons on the

control is pressed or the door is opened while in Dormant Mode. Press and hold **Control Lock** and **Turbo Freeze** for 3 seconds again will disable Dormant Mode.

## Features

### Key-Ejecting Lock

The lock is spring loaded so the key cannot be left in the lock. To lock or unlock, press the key in while turning. If the key is lost, you can order a replacement by calling GE Appliances at 800GE (800.492.2737) during normal business hours. Provide the model and serial number of the freezer when requesting a replacement key.

### WARNING

To prevent a child from being entrapped, keep the key out of reach of children and away from the freezer.

### Drawers/Basket

The drawers or basket provide separate storage spaces for items that are difficult to store on shelves. To remove the drawers or basket, pull out and lift up.

### Adjustable Shelves

The shelves are adjustable, some are full depth and the others are partial depth. The full depth shelf shall be installed to a higher position where the unit is deeper; and the partial depth shelf shall be installed to a lower position where the unit is shallower.

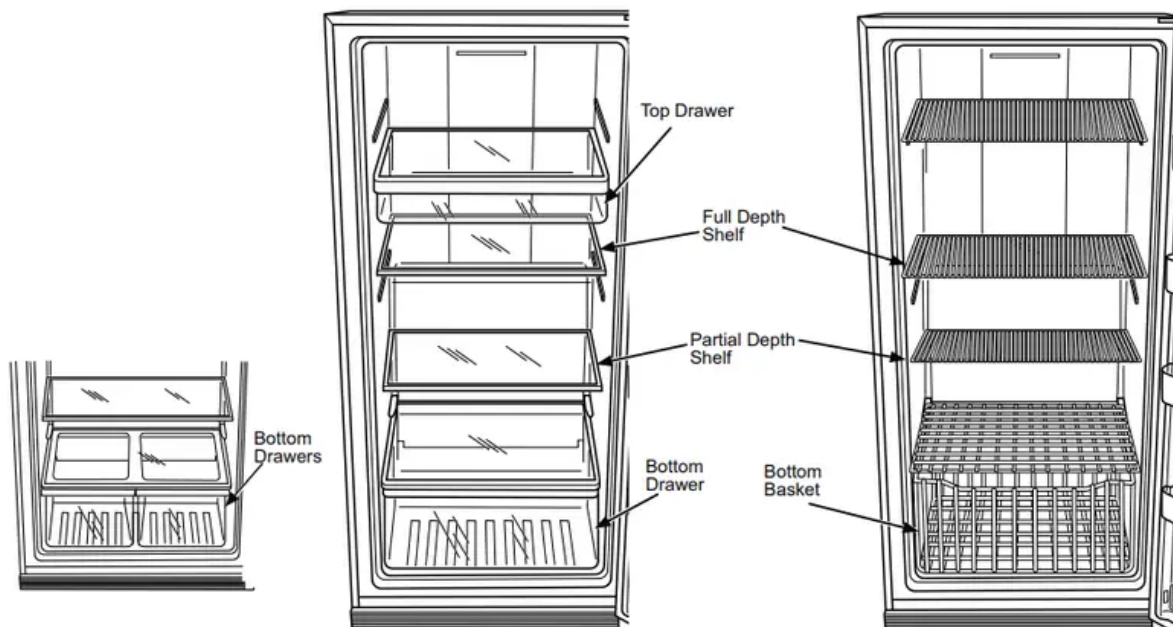

### Door Bins

There are 3 full depth door bins and one partial depth door bin on the unit. The partial depth door bin should always be installed at the bottom.

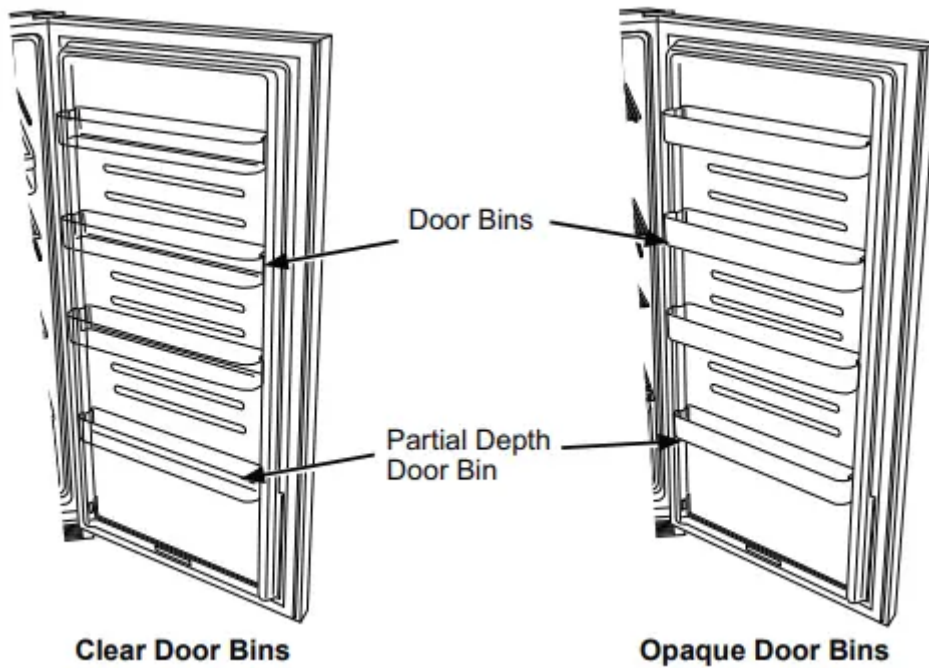

## CARE AND CLEANING

### Cleaning the Inside

To help prevent odors, leave an open box of baking soda in the freezer.

Unplug the freezer before cleaning. If this is not practical, wring excess moisture out of sponge or cloth when cleaning around switches, lights or controls. Use warm water and baking soda solution--about a tablespoon (15 ml) of baking soda to a quart (1 liter) of water. This both cleans and neutralizes odors. Thoroughly rinse and wipe dry.

**CAUTION** Do not clean glass shelves with warm water when they are cold. Glass shelves may break if exposed to sudden temperature changes or impact such as

bumping or dropping. Tempered glass is designed to shatter into many small pieces if it breaks.

Do not wash any plastic freezer parts in the dishwasher.

Do not clean with any products containing detergent, bleach or ammonia. They may damage the freezer.

After cleaning the door gaskets, apply a thin layer of petroleum jelly to the door gaskets at the hinge side. This helps keep the gaskets from sticking and bending out of shape.

### Cleaning the Outside

#### Directions for Cleaning Outside Surfaces, Door Handles, and Trim

DO USE	DO NOT USE
Soft, clean cloth or sponge	Abrasive cloths, scrubbing sponges, scouring or steel wool pads
<p>Mild detergent mixed with warm water Approved stainless steel cleaners; Visit the GE Appliances parts store for approved stainless steel cleaners: <b>GEAppliancesparts</b> or call <b>877.959.8688</b></p> <p>Cleaners with oxalic acid such as Bar Keepers Friend Soft Cleanser™ can be used to remove surface rust, tarnish and small blemishes.</p>	<p>Abrasive powders or sprays</p> <p>Window Sprays or Ammonia Citrus or plant oil-based cleaners</p> <p>Acidic or vinegar-based cleaners</p> <p>Oven cleaners</p> <p>Cleaners containing acetone (propanone)</p> <p>Any cleaner with WARNING about plastic contact</p>

**NOTE:** DO NOT allow stainless steel cleaner to come in contact with any plastic parts such as trim pieces, handle hardware and liners. If unintentional contact of cleaners with plastic parts does occur, clean plastic part with a sponge and mild detergent mixed with warm water.

## No Defrosting

You never have to defrost your new No-Frost freezer. It has been pre-set at the factory to defrost itself automatically.

During defrosting, a slight noise may be noticed if the door is opened while the freezer is in the automatic defrosting cycle.

## To Remove the Freezer Door

1. Remove the plastic hinge cover by removing one screw, disconnect the wiring connector and remove the ambient thermistor from the hinge cover, and then lifting it off.
2. Remove the screws holding the hinge to the top of the cabinet using a Phillips screwdriver or 5/16" socket driver. Be carefully not to damage the wiring nearby.



3. Remove the top hinge from the cabinet and lift the door up and off the lower hinge pin. Set the door aside.

4. Remove the screws from the bottom hinge.

To replace the doors, reverse the order of the above instructions.

**NOTICE:** It is very important that all hinge screws are securely tightened to ensure a secure assembly and prevent hinge slippage. Do not overtighten the hinge screws. Tighten them until they are just snug, and then turn them another one-half turn.

**NOTE:** The door swing is not reversible.

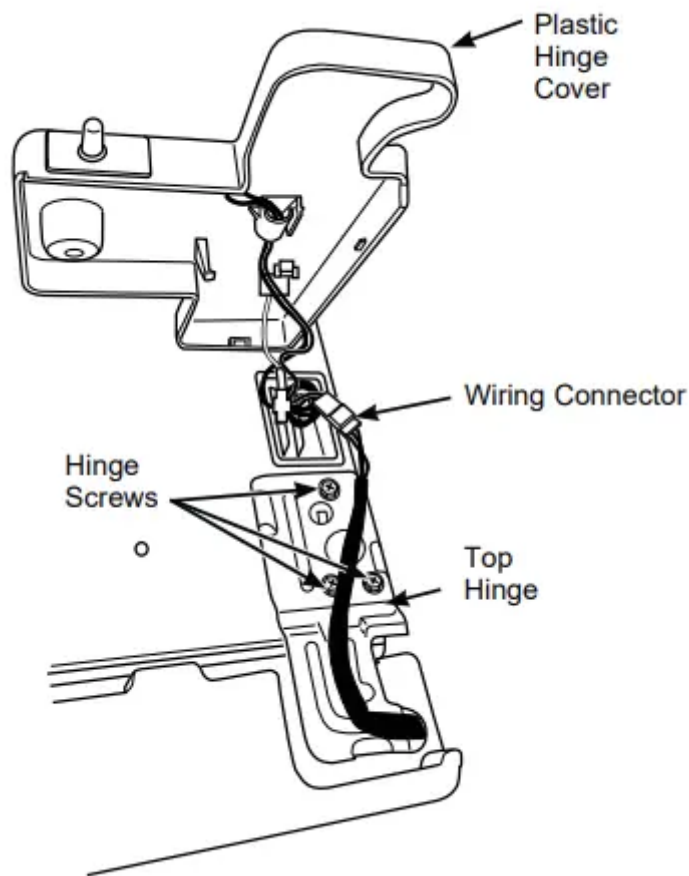

### Replacing the LED Light

The LED light is located behind a light lens in the ceiling of the Freezer section.

#### To replace the LED light:

1. Remove the top shelf (if necessary).
2. Gently push the three snap-in tabs at the front of the lens, release the lens from the liner, and pull to remove.
3. Remove the LED assembly from the mounting tabs.
4. Gently pull the leads out and disconnect from the unit.

5. Replace with new LED assembly and slide assembly back into mounting tabs.
6. Replace the light lens by sliding the tabs at the back of the lens into the slots and push up on the lens until the tabs at the front of the lens snap into place.

To order the LED assembly, please call GE Appliances at 800GECARES (800.492.2737) during normal business hours.

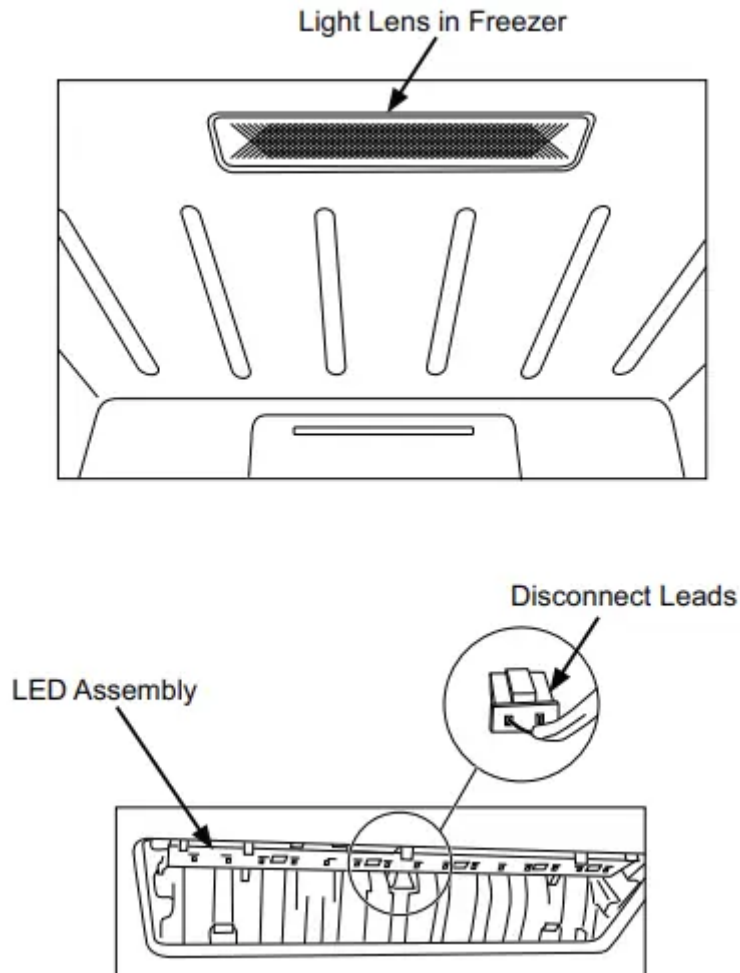

### In Case of Extended Power Failure

- Keep freezer door closed. Your freezer will keep food frozen for 24 hours provided warm air is not admitted.
- If freezer is out of operation for 24 hours or more, add dry ice. Leave ice in large pieces. Add more ice as required.

**CAUTION** Handling of dry ice can cause freezing of the hands—gloves or other protection is recommended.

- If dry ice is not available, move food to a frozen food locker temporarily—until power is restored.

## Preparing to Move

Disconnect the power cord plug from the wall outlet. Remove foods and clean the freezer.

Secure all loose items such as baskets and shelves by taping them securely in place to prevent damage.

Be sure freezer stays in upright position during actual moving and during transportation. The freezer must be secured during transportation to prevent movement. Protect outside of freezer with blanket.

## Preparing for Vacation

To maintain freezer in operation during vacations, be sure your house power is not turned off. For sure protection of freezer contents, you may want to ask a neighbor to check the power supply and freezer operation every 48 hours.

For extended vacations or absences, you may prefer to move your frozen foods to a storage locker temporarily. If your freezer is to be left empty, disconnect power cord plug from wall outlet. To prevent formation of odors, place open box of baking soda in freezer and leave freezer door open.

When the freezer is not operating, it can be left in an unheated house or room without damage to cabinet or mechanism.

## Save Money/Save Energy



- The freezer should be located in the coolest area of the room, away from heat-producing appliances or heating ducts, and out of direct sunlight.
- Let hot foods cool to room temperature before placing in the freezer. Overloading the freezer forces the compressor to run longer. Foods that freeze too slowly may lose quality or spoil.
- Be sure to wrap foods properly, and wipe containers dry before placing them in the freezer. This cuts down on frost buildup inside the freezer.
- Organize and label food to reduce door openings and extended searches. Remove as many items as needed at one time, and close the door as soon as possible.

# INSTALLATION INSTRUCTIONS

## Installing the Freezer

### Freezer Location

Your freezer should be conveniently located for day-to-day use in a dry, well-ventilated room.

Do not install the freezer where the temperature will go below 0°F or above 110°F, because it will not maintain proper temperatures.

Be sure to install your freezer on a floor strong enough to support it when it is fully loaded.

Do not install the freezer in a location exposed to rain water or direct sunlight.

### Clearances

On all models, allow 3" (76 mm) on top, back and sides for proper air circulation.

### Adjustable Legs

Legs at the front corners of the freezer should be set so the freezer is firmly positioned on the floor, and the front is raised just enough so the door closes easily when opened about halfway.

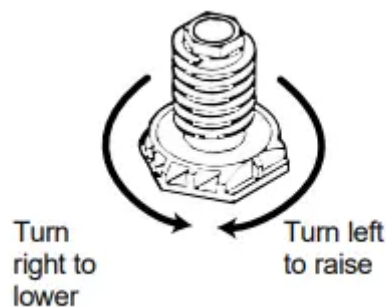

### Level Freezer

Use a carpenter's level to level the freezer from back to front. Adjust the plastic leveling feet in front 1/2 bubble higher so the door closes easily when left open.

### Door Handle

Shape of handle may vary on your model.

1. Align the handle with fasteners.
2. Push the handle over fasteners until it touches the door.
3. Use the alien wrench to turn set screw clockwise to fasten the handle to the door.

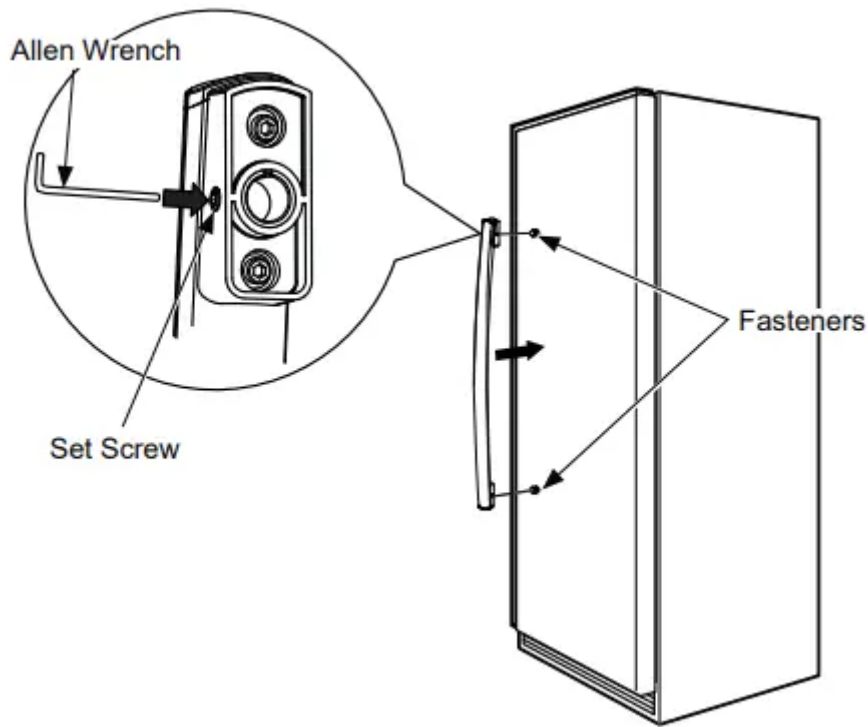

### Unit Loading

**NOTICE:** To allow the door to close and seal properly, DO NOT let food packages extend past the front of the shelves.

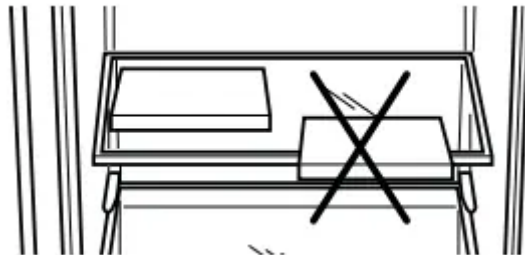

### Troubleshooting Tips... Before you call for service

Save time and money! Review the charts on the following pages first and you may not need to call for service

<b>Problem</b>	<b>Possible Causes</b>	<b>What to Do</b>
<b>Freezer does not operate</b>	Freezer is unplugged.	Push the plug completely into the outlet.
	The fuse is blown/circuit breaker is tripped.	Replace fuse or reset the breaker.
	"Demo" LED light is on and Freezer is in Demo mode.	Please press "Alarm Reset" first, and then press the "-" and "+" immediately while holding "Control Lock" at the same time for 5 seconds and release. "Demo" LED light will be off.
<b>Freezer starts/stops too frequently</b>	Door left open.	Check to see if package is holding door open.
	Too frequent or too long door openings.	Open the door less often.
	Temperature control set too cold.	See Temperature Control
<b>Freezer operates too long</b>	Door left open.	Check to see if package is holding door open.
	Too frequent or too long door openings.	Open the door less often.
	Temperature control set too cold	See Temperature Control
	Inadequate air circulation space around cabinet	See Installing the Freezer.
	Room or outside weather is hot.	It's normal for the freezer to work harder under these conditions.
	Freezer has been disconnected recently for a period of time	It takes 4 hours for the freezer to cool down completely

	Large amounts of warm or hot food have been stored recently.	Warm food will cause the freezer to run more until the desired temperature is reached
<b>Noisy operation or cabinet vibrates</b>	Floor may be weak, causing freezer to vibrate when compressor is on.	Check to make sure freezer is located on solid floor and adjust leveling legs as needed.
	Cabinet is not positioned solidly on floor	Adjust legs. See Installing the Freezer. Or use shims for uneven floor.
	Freezer is touching the wall.	Level freezer or move slightly. See Level Freezer.
<b>Freezer temperature too warm</b>	Door left open.	Check to see if package is holding door open.
	Too frequent or too long door openings	Open the door less often.
	Temperature control is set too warm.	Turn control to a colder setting. Allow several hours for the temperature to stabilize.
	Large amounts of water or hot food may have been stored recently	Wait until the freezer has had a chance to reach its selected temperature.
	Freezer has been disconnected recently.	Warm food will cause the freezer to run more until the desired temperature is reached
<b>Foods defrosting</b>	High temp alarm is on and temperature display is flashing.	Power outage may have caused high internal temperature.
	Freezer is unplugged.	Push the plug completely into the outlet.
	The fuse is blown/circuit breaker is tripped.	Replace fuse or reset the breaker.
	Door left open.	Check to see if package is holding door open.

	Too frequent or too long door openings.	Open the door less often.
<b>Freezer temperature too cold</b>	Temperature control set too cold.	See About the operation of your freezer
<b>Moisture forms on outside of cabinet</b>	Not unusual during periods of high humidity	Wipe surface dry.
	Door may not be seating properly, causing cold air from inside the freezer to meet warm moist air from the outside.	See Preparing to install the freezer.
<b>Interior light does not work</b>	No power at outlet.	Replace fuse or reset the breaker
	Freezer is unplugged.	Push the plug completely into the outlet
	LED light burned out.	Replace the LED.
<b>Door won't fully close by itself</b>	Legs need adjusting.	See Preparing to install the freezer.
	Package holding door open.	Move package to a different location.
<b>Slow starting time after being off</b>	Built-in overload protection.	This is normal after being off.
<b>Excessive frost buildup</b>	Door left open.	Check to see if package is holding door open.
	Too frequent or too long door openings.	Open the door less often.
	Not unusual during periods of high humidity.	Wipe surface dry
<b>Freezer external surface</b>	The external freezer walls can be as much as 30°F	This is normal while the compressor works to transfer

<b>temperature is warm</b>	warmer than room temperature.	heat from inside the freezer cabinet.
<b>Louder sound levels whenever freezer is on</b>	Modern freezers have increased storage capacity and more stable temperatures. They require a highefficiency compressor.	This is normal. When the surrounding noise level is low, you might hear the compressor running while it cools the interior.
<b>Higher sound levels when compressor comes on</b>	Freezer operates at higher pressures during the start of the ON cycle	This is normal. Sound will level off or disappear as freezer continues to run.
<b>Popping or cracking sound when compressor comes on</b>	Metal parts undergo expansion and contraction, as in hot water pipes.	This is normal. Sound will level off or disappear as freezer continues to run
<b>Bubbling or gurgling sound, like boiling water</b>	Refrigerant (used to cool freezer) is circulating throughout the system	This is normal.
<b>Moisture forms on inside freezer walls</b>	Weather is hot and humid, which increases internal rate of frost buildup	This is normal.
	Door may not be seating properly.	See Preparing to install the freezer.
	Door is kept open too long, or is opened too frequently.	Open the door less often.
<b>Odors in freezer</b>	Interior needs to be cleaned.	Clean interior with sponge, warm water and baking soda.
	Foods with strong odors are in the freezer.	Cover the food tightly.

## Normal Operating Characteristics

- A warm cabinet exterior as the refrigeration system transfers heat from the inside to the outside through the exterior cabinet walls.

- The sound of the high-efficiency compressor motor.
- The sound of water dripping as it melts from the evaporator and escapes to the drain pan during defrost cycle.
- The sound of the fan circulating air within the interior of the cabinet providing a consistent temperature throughout.

**Warning**

This content is compiled from multiple sources and is provided for reference purposes only. It may not be complete or fully applicable to all situations. If you are unable to resolve your issue, please contact the product manufacturer or an authorized service provider for official support.

