

What's New in Your Dishwasher

Energy

Congratulations on purchasing your water and energy-efficient dishwasher! This dishwasher cleans by spraying the dishes with water and pauses to allow the detergent to soak into and release the soil on the dishes. The cycles are longer due to the soak and pause for exceptional cleaning. Several models contain an optical water sensor. The optical water sensor is used to determine the optimum water and energy consumption for great cleaning performance. Efficient dishwashers run longer to save water and energy, just as driving a car slower saves on gas. The first cycle using the sensor will run longer to calibrate the optical sensor.

Performance

Rinse Aid

Using a rinse aid will optimize your drying and wash performance. This dishwasher is specifically designed to be used with rinse aid for improved drying performance and controlling the buildup of hard water deposits. Energy-efficient dishwashers use less water and energy, so they depend on the water "sheeting" action of the rinse aid for total optimal performance.

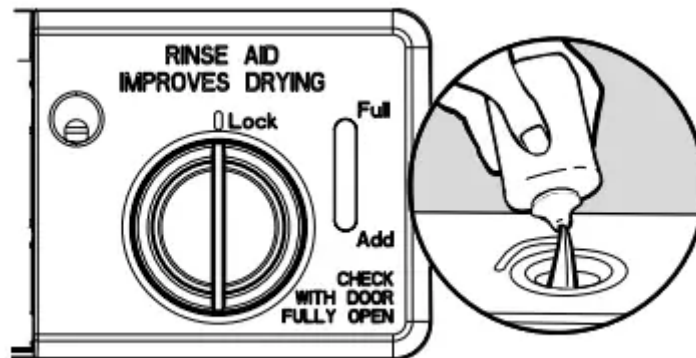

Detergent

The United States and Canada have passed a restriction limiting the amount of phosphorus (phosphates) in household dishwasher detergents. Major manufacturers have reformulated their dishwasher detergent for this change in detergents as another step in eco-conscious awareness. With these recent changes, it is recommended to use tablets and packs for convenience and improved performance

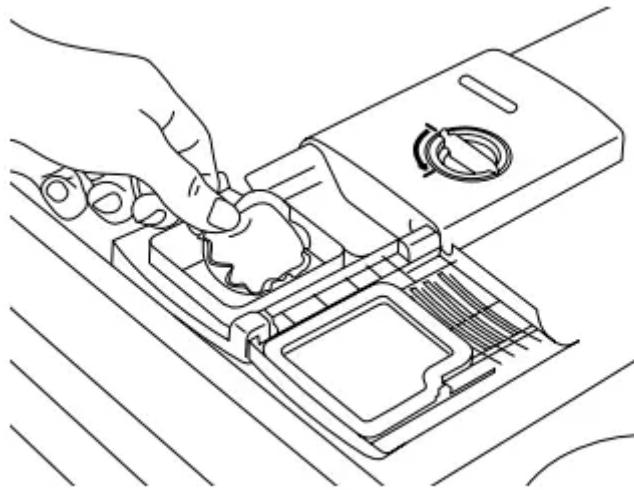

Filtration System

Your dishwasher has the latest technology in dishwasher filtration. This triple filtration system minimizes sound and optimizes water and energy conservation while providing optimal cleaning performance. Maintenance of your filters regularly will sustain peak cleaning performance. We suggest you clean both your upper and lower filter and rinse under running water at least once a month.

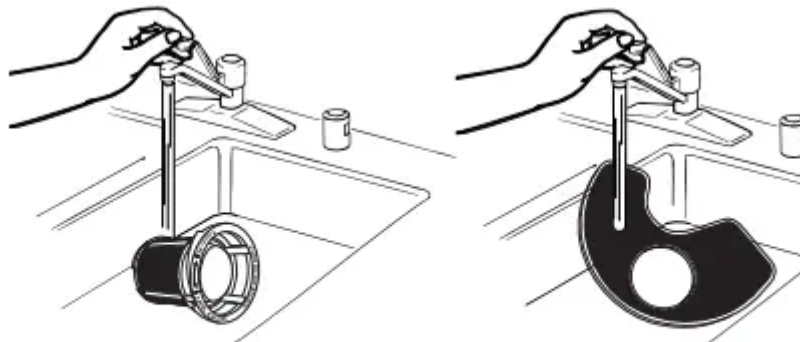

Parts and Features

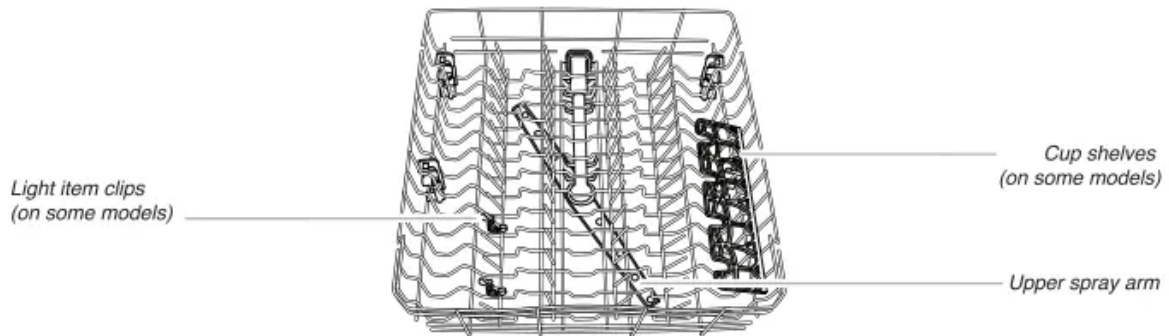
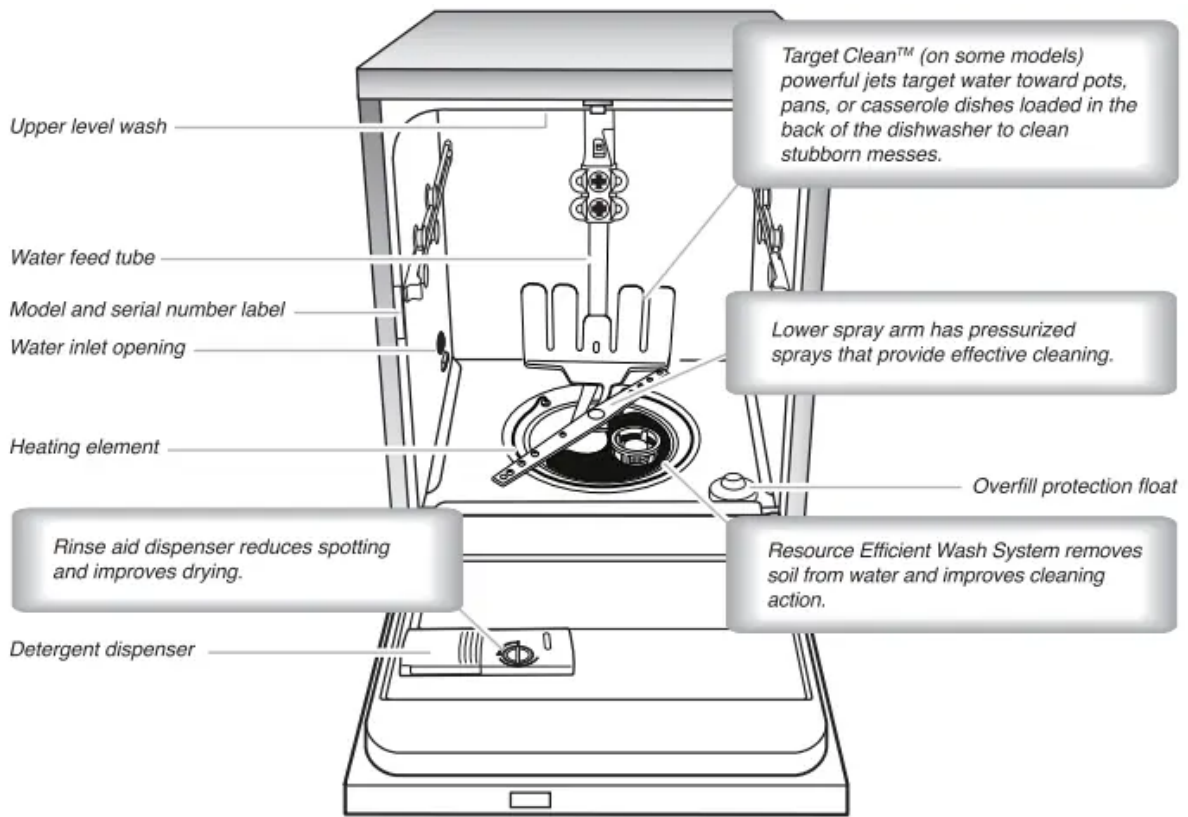

TOP RACK

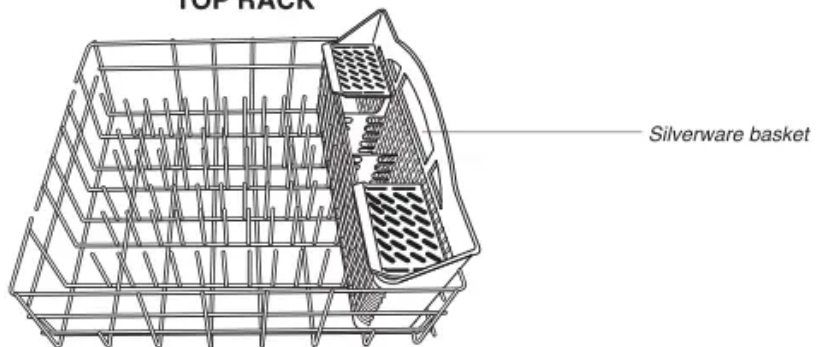

BOTTOM RACK



Quick Steps

1. Prepare and load the dishwasher. Spin the spray arms.

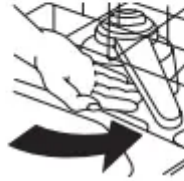
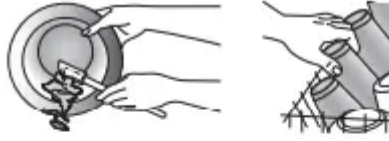

2. Add detergent and rinse the aid.

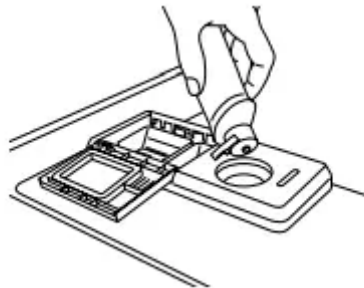
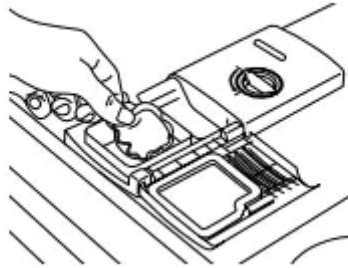

3. Select a cycle and option (cycles and options vary by model).

4. Start the dishwasher. Push the door firmly closed. The door latches automatically. Select the wash cycle options and press START/RESUME or press START/RESUME to repeat the same cycle and options as in the previous wash cycle. NOTE: If the Start/Resume button is located on the top of the door, push the door firmly closed within 4 seconds of pressing Start/Resume.

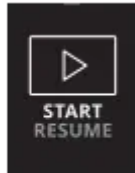

5. Unload and clean the filter. See “Recommended Time Interval to Clean Your Filter,” in the “Filtration System” section for the recommended cleaning schedule

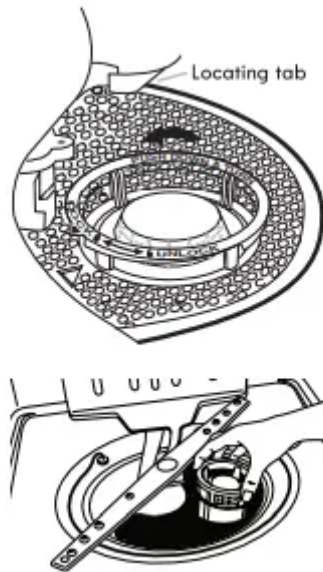

Dishwasher Use

Step 1

Prepare and Load the Dishwasher

IMPORTANT: Remove leftover food, bones, toothpicks, and other hard items from the dishes. Remove labels from containers before washing.

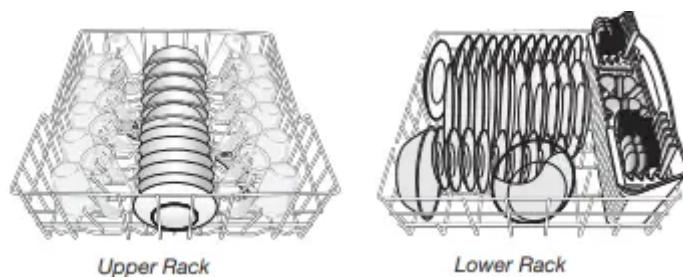

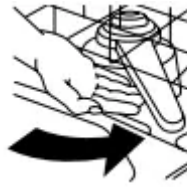

- Make sure nothing keeps spray arm(s) from spinning freely. It is important for the water spray to reach all soiled surfaces.
- Make sure that when the dishwasher door is closed and no items are blocking the detergent dispenser.
- Items should be loaded with soiled surfaces facing down and inward to the spray as shown in the graphics above. This will improve cleaning and drying results.
- Avoid overlapping items, like bowls or plates, that may trap food.
- Place plastics, small plates, and glasses in the upper rack.
- Wash only items marked “dishwasher safe.”
- To avoid thumping/clattering noises during operation: Load dishes so they do not touch one another. Make sure lightweight load items are secured in the racks.
- When loading silverware, always place sharp items pointing down and avoid “nesting” as shown. If your silverware does not fit into the designated slots, flip the covers up and mix silverware types to keep them separated.
- Use suggested loading patterns, as shown, to better clean your silverware. Use the slots in the covers to keep your silverware separated for an optimum wash.



Step 2

Add Detergent

NOTE: If you do not plan to run a wash cycle soon, run a rinse cycle. Do not use detergent.

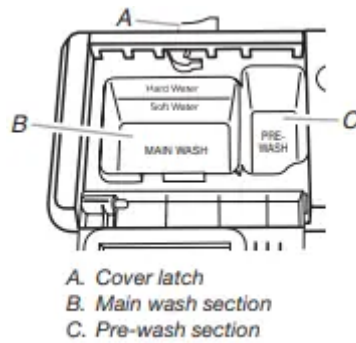

- Use automatic dishwasher detergent only. Add powder, liquid, or tablet detergent just before starting a cycle.
- Fresh automatic dishwasher detergent results in better cleaning. Store a tightly closed detergent container in a cool, dry place.
- For optimum performance, tablet detergent is recommended.
- The amount of detergent to use depends on: How much soil remains on the items – Heavily soiled loads require more detergent. The hardness of the water – If you use too little detergent in hard water, dishes won't be clean. If you use too much in soft water, glassware will etch. Soft to Medium Water (0–6 grains per U.S. gallon) [typical water softener water and some city water] Medium to Hard Water (7–12 grains per U.S. gallon) [well water and some city water]
- Depending on your water hardness, fill the Main Wash section of the dispenser as shown. Fill the Pre-Wash section to the level shown for heavily soiled items.

NOTE: Fill amounts shown are for standard powdered detergent. Follow the instructions on the package when using another dishwasher detergent.



Add Rinse Aid

- Your dishwasher is designed to use a rinse aid for good drying performance. Without a rinse aid, your dishes and dishwasher interior will have excessive moisture. The Heat Dry option will not perform as well without a rinse aid.
- Rinse aid keeps water from forming droplets that can dry as spots or streaks. They also improve drying by allowing water to drain off of the dishes after the final rinse.
- Check the rinse aid indicator. Add rinse aid when indicator drops to “Add” level.
- To add rinse aid, turn the dispenser cap 1/4 turn counterclockwise, and lift off. Pour rinse aid into the opening until the indicator level is at “Full.” Replace the dispenser cap and turn to “Lock

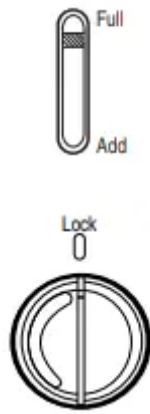

NOTE: For most water conditions, the factory setting will give good results.

- Check the water hardness level to ensure there are no rings or spots on your dishware before adding a rinse aid or adjusting the factory setting.
- If you have hard water or notice rings or spots, try a higher setting. Turn the arrow adjuster inside the dispenser by either using your fingers or inserting a flat-blade screwdriver into the center of the arrow and turning.



Step 3

Select a Cycle (cycles vary by model): See the “Cycle and Option Descriptions” charts in the following section. Heavier cycles and options affect cycle length.

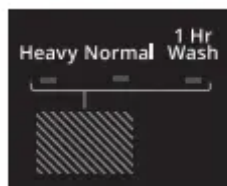

Select Options (options vary by model): See the “Cycle and Option Descriptions” charts in the following section. You can customize your cycles by pressing the options desired.

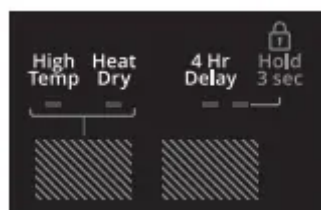

Step 4

Start or Resume a Cycle

- Run hot water at the sink nearest to your dishwasher until the water is hot. Turn off the water.
- For best dishwashing results, water should be 120°F (49°C) as it enters the dishwasher.
- Push the door firmly closed. The door latches automatically. Select the wash cycle, and options and press START/RESUME or press START/RESUME to repeat the same cycle and options as in the previous wash cycle. For models with controls on top of the door, select the wash cycle, option, and press START/RESUME within 4 seconds of closing the door.

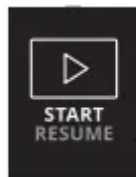



- You can add an item anytime at the beginning of the cycle. Open the door slowly and add the item. Close the door firmly. Press START/RESUME.

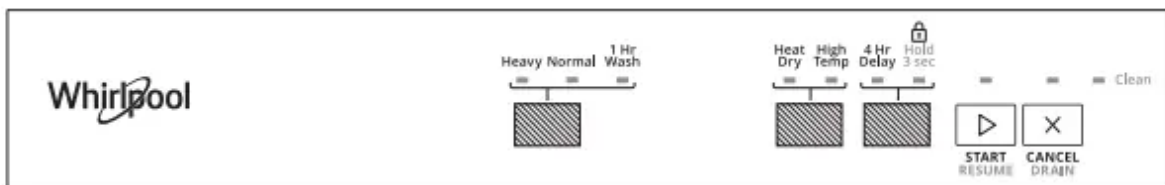

Cycle and Option Descriptions





This information covers several different models. Your dishwasher may not have all of the cycles and options described. Estimated cycle times may increase or decrease depending on water temperature, soil conditions, dish load size, and options selected. You can customize your cycle by selecting an option. See option selections. If you change your mind, press the option again to turn off the option or select a different option. You can change an option anytime before the selected option begins. At each stage of the wash cycle, you may hear noises that you are not used to hearing in your previous dishwasher. Each cycle will provide a series of pauses and water sprays throughout the wash cycle. This is normal and will provide optimal cleaning performance.

CYCLE SELECTIONS			
CYCLES		ESTIMATED WASH TIME (HH:MM)	WATER USAGE GALLONS (LITERS)
 Heavy	Use for hard-to-clean, heavily soiled pots, pans, casseroles, and tableware.	3:28	7.4 (28.1)
 Normal	This cycle with only the Heat Dry option selected, and without other options selected, is recommended to completely wash and dry a full load of normally soiled dishes. The energy usage label is based on this cycle and option combination.	2:32	2.4 to 7.4 (9.09 to 28)
 1 Hr Wash	For fast results, 1 Hr Wash will clean dishes using slightly more water and energy. Select the Heat Dry option to provide best drying performance.	1:00	7.87 (29.8)

IMPORTANT: The sensor in your dishwasher monitors the soil level. Cycle time and/or water usage can vary as the sensor adjusts the cycle for the best wash performance. If the incoming water is less than the recommended temperature or food soils are heavy, the cycle will automatically compensate by adding time, heat, and water as needed.

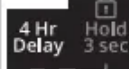
OPTION SELECTIONS					
OPTIONS		CAN BE SELECTED WITH	WHAT IT DOES	ADDED TIME TO CYCLE	ADDED WATER GALLONS (LITERS)
 High Temp	High Temp raises main wash temperature to improve cleaning for loads containing tough, baked-on food.	All cycles	Raises the main wash temperature to 135°F (57°C).	0:05 to 0:13	0 to 3.86 (0 to 14.6)
 Heat Dry	Heat Dry dries dishes with heat. This option, with the use of rinse aid, will provide the best drying performance. Plastic items are less likely to deform when loaded in the top rack. Use Heat Dry for optimum drying performance. Turn the Heat Dry option off for air dry.	All cycles	Uses heating element to speed drying times. Heat Dry option defaults to on when any cycle is selected except for 1 Hr Wash.	0:08 to 0:46	0

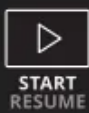
OPTION SELECTIONS					
OPTIONS		CAN BE SELECTED WITH	WHAT IT DOES	ADDED TIME TO CYCLE	ADDED WATER GALLONS (LITERS)
 4 Hr Delay	Runs dishwasher at a later time. Select a wash cycle and options. Each time you press the Delay button, it will display the next available delay time. Press 4 HR DELAY. Press START/RESUME. Close door firmly. NOTES: <ul style="list-style-type: none"> The dishwasher remembers the last Delay you selected. To reset the Delay time to something other than what is displayed, continue to press the Delay button until the desired delay time is reached. Anytime the door is opened (such as, to add a dish), Start/Resume must be pressed again to resume delay countdown. 	Available with any cycle	Delay 4 hours	0:00	0
 4 Hr Delay Hold 3 sec	To turn on lock, press and hold 4 HR DELAY for 3 seconds. Control Lock light will stay on for a short time, indicating that it is activated and all buttons are disabled. If you press any button while your dishwasher is locked, a light flashes three times. Dishwasher door can still be opened/closed while the controls are locked. To turn off Lock, press and hold 4 HR DELAY for 3 seconds. Light turns off.				

CONTROLS AND CYCLE STATUS		
CONTROL	PURPOSE	COMMENTS
 START RESUME	Press to start or resume a wash cycle.	Press to start or resume a wash cycle.
 CANCEL DRAIN	Press to cancel wash cycle.	If the door is opened during a cycle or the power is interrupted, the Start/Resume button LED flashes. Cycle will not resume until door is closed and Start/Resume is pressed. Press to cancel wash cycle.
 Clean	The Clean indicator glows when a cycle is finished.	Close the door firmly. The dishwasher starts a 2-minute drain (if needed). Let dishwasher drain completely. Press CANCEL again to fully cancel machine.



Top Rack Loading

Loading Recommendations

Place cups and glasses in the rows between tines. Placing them over the tines can lead to breakage and water spots. To avoid damage to your delicate items, be sure china, crystal, stemware, and other similar items do not touch during dishwasher operation.

Load lightweight and dishwasher-safe plastic items only in the top rack.

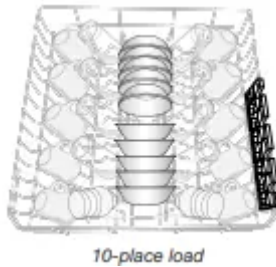

Removable Top Rack

The removable rack allows you to wash larger items, such as stock pots, roasters, and cookie sheets, in the lower-level rack.

IMPORTANT: Remove dishes prior to removing the upper rack from the dishwasher.

To remove the rack (push tab rack stop):

1. Roll the rack 1/3 to 1/2 of the way out.
2. Remove each plastic push tab rack stop from the end of each track by pushing inward toward the rack on the ridged area of the rack stop. The rack stop will snap open and can be easily removed by pulling straight out. Be sure to support the track while removing rack stops.
3. Roll the rack all the way out of the track and remove it from the dishwasher.

To replace the rack:

Reverse the above steps 1 through 3 to replace the rack in the dishwasher



Filtration System

Your dishwasher has the latest technology in dishwasher filtration. This triple filtration system minimizes sound and optimizes water and energy conservation while providing superior cleaning



performance. Throughout the life of your dishwasher, the filter will require maintenance to sustain peak cleaning performance.

The triple filter system consists of two parts, an upper filter assembly, and a lower filter.

- The upper filter assembly keeps oversized items and foreign objects, along with very fine food particles, out of the pump.
- The lower filter keeps food from being recirculated onto your dishware.
- The filters may need to be cleaned when:
 - Visible objects or soils are on the upper filter assembly.
 - There is degradation in cleaning performance (that is, soils are still present on dishes).
 - Dishes feel gritty to the touch.

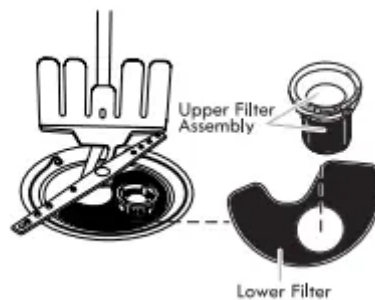

It is very easy to remove and maintain the filters. The chart below shows the recommended cleaning frequency.

RECOMMENDED TIME INTERVAL TO CLEAN YOUR FILTER			
Number of Loads Per Week	If you only scrape before loading*	If you scrape and rinse before loading	If you wash before loading
8-12	Every two months	Every four months	Once per year
4-7	Every four months	Once per year	Once per year
1-3	Twice per year	Once per year	Once per year

*Manufacturer’s recommendation: This practice will conserve the water and energy that you would have used to prepare your dishes. This will also save you time and effort.

Very Hard Water

If you have hard water (above 15 grains), clean your filter at least once per month. Building up of white residue on your dishwasher indicates hard water. For tips on removing spots and stains, see the “Troubleshooting” section.

Filter Removal Instructions

1. Turn the upper filter assembly 1/4 turn counterclockwise and lift out.
2. Separate the upper filter assembly by gently pulling it apart.
3. Clean the filters as shown.



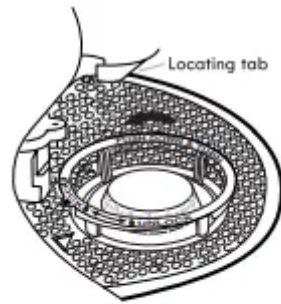

To remove upper filter assembly



Cleaning Instructions

IMPORTANT: Do not use wire brushes, scouring pads, etc., as they may damage the filters.

Rinse the filter under running water until most soils are removed. If you have hard-to-remove soils or calcium deposits from hard water, a soft brush may be required.

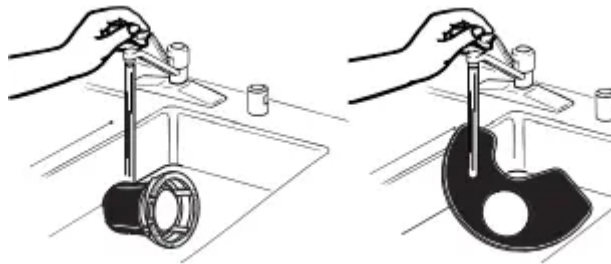

Filter Reinstallation Instructions

1. Noting the previous illustrations, place the lower filter under the locating tabs at the bottom of the dishwasher so the round opening for the upper filter assembly lines up with the round opening at the bottom of the tub.
2. Insert the upper filter assembly into the circular opening in the lower filter.



3. Slowly rotate the filter clockwise until it drops into place. Continue to rotate until the filter is locked into place. If the filter is not fully seated (still turns freely), continue to turn the filter clockwise until it drops and locks into place.

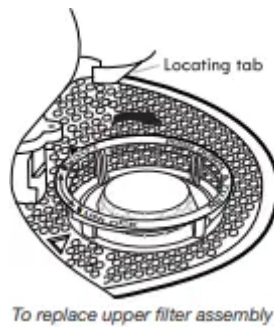

NOTE: The upper filter assembly arrow does not have to align with the arrow in the lower filter as long as the filter is locked.

IMPORTANT: To avoid damage to the dishwasher, do not operate your dishwasher without the filters properly installed. Be sure the lower filter is securely in place and the upper filter assembly is locked into place. If the upper filter assembly turns freely, it is not locked into place.

Dishwasher Care

Cleaning the Exterior

Clean the exterior of the dishwasher with a soft, damp cloth and mild detergent. If your dishwasher has a stainless steel exterior, a stainless steel cleaner, such as affresh®† Stainless Steel Cleaner, is recommended. Avoid using abrasive cleaning products on the exterior of the dishwasher.

Cleaning and Maintaining the Interior

Many detergents may leave white spots or a white residue on dishware and on the interior of the dishwasher. Over time this residue can become unsightly and could affect dishwasher performance. Use of a dishwasher cleaning product, such as affresh® Dishwasher Cleaner, can help to remove the residue. Monthly use of affresh® Dishwasher Cleaner is recommended to help maintain the dishwasher.

To Use:

1. **If cleaning without dishes, place one tablet in the detergent dispenser. Do not add detergent. (If significant buildup is noticeable, a second tablet can be placed in the bottom of the dishwasher.)**
2. **If cleaning with dishes, place one tablet in the bottom of the dishwasher. Place detergent in the dispenser.**
3. **Run a Normal wash cycle. Another method to remove white residue is to use a vinegar rinse. However, vinegar is an acid, and using it too often could damage your dishwasher. Place (do not pour) 2 cups (500 mL) of white vinegar in a glass or dishwasher-safe measuring cup on the bottom rack. Run the dishwasher through a complete washing cycle using an air-dry or an energy-saving dry option. Do not use detergent. Vinegar will mix with the wash water.**

NOTE: Whirlpool recommends the use of high-quality, premeasured detergent tablets or packs and the use of a rinse aid for dishwasher cleaning and daily care.

If you have a drain air gap, check and clean it if the dishwasher isn't draining well.



To Reduce the Risk of Property Damage During Vacation or Extended Time Without Use:

- When you will not be using the dishwasher during the summer months, turn off the water and power supply to the dishwasher.
- Make sure the water supply lines are protected against freezing conditions. Ice formations in the supply lines can increase water pressure and cause damage to your dishwasher or home.
- Damage from freezing is not covered by the warranty.
- When storing your dishwasher in the winter, avoid water damage by having your dishwasher winterized by authorized service personnel.

Troubleshooting

The dishwasher is not operating properly

- **The dishwasher does not run or stop during a cycle**

It is normal for certain cycles to repeatedly pause for several seconds during the main wash.

Is the door closed tightly and latched?

Is the right cycle selected?

Is there power to the dishwasher? Has a household fuse, blown, or has a circuit breaker tripped? Replace the fuse or reset the circuit breaker. If the problem continues, call an electrician.

Has the motor stopped due to an overload? The motor automatically resets itself within a few minutes. If it does not restart, call for service.

Is the water shut-off valve (if installed) turned on?

- **The Clean light is flashing**

Check the following:

- Is the overflow protection float able to move up and down freely? Press down to release.
- Be sure the water supply is turned on to the dishwasher. (This is very important following the new installation of your dishwasher.)
- Check for suds in the dishwasher. If foam or suds are detected by the dishwasher sensing system, the dishwasher may not operate properly or may not fill with water.

Suds can come from:

1. Using the incorrect type of detergent, such as laundry detergent, hand soap, or dish detergent for hand washing dishes.
2. Forgetting to replace the rinse aid dispenser cap after filling (or refilling) the rinse aid.
3. Using an excessive amount of dishwasher detergent.

- **The Dishwasher will not fill**

Is the overflow protection float able to move up and down freely? Press down to release.

- **The dishwasher seems to run too long**

Try the 1 Her Wash cycle.

Is the water supplied to the dishwasher hot enough? The dishwasher runs longer while heating water.

Is the dishwasher cycle time within the cycle times? See the cycle section's wash times. A delay automatically occurs in some wash and rinse cycles until the water reaches the proper temperature.

This dishwasher is equipped with an optical sensor wash that detects water temperature, soil, and detergent amount. Wash cycles are adjusted based on load sensing.

IMPORTANT: The very first wash cycle after installation in your home will be adjusted to include an additional two rinses. This cycle must not be interrupted for proper sensor adjustment. If this adjustment cycle is canceled or stopped before the Clean light comes on at the end of the cycle, the next wash cycle will repeat this sensor adjustment.

- **Water remains in the dishwasher**

Is the cycle complete? Was the disposer knockout plug removed during installation? (See the “Install the drain hose” section in the Installation Instructions.)

Detergent remains in the covered section of the dispenser

Is the cycle complete?

Check for items, such as cookie sheets, cutting boards, or large containers, that may be blocking the detergent dispenser from opening properly.

Be sure the cycle has finished (the green light is on). If it has not finished, you will need to resume the cycle by pressing Start/ Resume and closing the door within 3 seconds.

Is the detergent lump-free? Replace detergent if necessary

- **White residue on the front of the access panel**

Was too much detergent used?

Is the brand of detergent making excess foam? Try a different brand to reduce foaming and eliminate buildup.

- **Odor in the dishwasher**

Are dishes washed only every 2 or 3 days?

Check and clean your filters regularly. See the table in the “Filtration System” section for “Recommended Time Interval to Clean Your Filter.”

Does the dishwasher have a new plastic smell? Run a vinegar rinse as described in “Dishwasher Care.”

To avoid odor, use affresh® dishwasher and disposal cleaner tablet once a month or as needed for a fresher dishwasher as described in “Dishwasher Care.”

- **Condensation on the kitchen counter (built-in models)**

Is the dishwasher aligned with the countertop? Moisture from the vent in the dishwasher console can form on the counter. Refer to the Installation Instructions for more information.

- **The bottom rack does not fully slide into the dishwasher**

Check to see if items loaded for the Target Clean™ wash option have shifted. Reload to keep items from interfering with spray jets or spray arms.

Dishes do not dry completely

- **Dishes do not dry completely**

Did you use a rinse aid? Your dishwasher is designed to use a rinse aid for good drying performance. Without a rinse aid, your dishes and dishwasher interior will have excessive moisture. The Heat Dry option will not perform as well without a rinse aid.

- **Dishes are not dry**

Did you load your dishwasher to allow proper water drainage?

Do not overload. Use a liquid rinse aid to speed drying.

Are the plastics wet? Plastics often need towel drying.

Is the rinse aid dispenser empty?

Did you use an air-dry or energy-saving dry option? Use a heated drying option for dryer dishes.

- **Excess moisture on racks and dishwasher interior**

Check the rinse aid indicator to see that there is a rinse aid in the dispenser.

Spots and stains on dishes

- **Spotting and filming dishes**

Is your water hard, or is there a high mineral content in your water? Conditioning the final rinse water with a liquid rinse aid helps eliminate spotting and filming. Keep the rinse aid dispenser filled. Always use a high-temp option. If your water hardness is 13 grains or above, it is strongly recommended that you install a home water softener. If you do not wish to drink softened water, have the softener installed onto your hot water supply.

Is the water temperature too low? For best dishwashing results, water should be 120°F (49°C) as it enters the dishwasher.

Did you use the correct amount of effective detergent? Use recommended dishwasher detergents only. Do not use less than 1 tbs (15 g) per load. The detergent must be fresh to be effective. Heavy soil and/or hard water generally require extra detergent. Using dishwasher detergent tablets and packs has been proven better than powder, liquid, or gel detergents to reduce filming on your dishes. Using these tablets and packs, over time will start to reduce or eliminate white film. Also, by using a rinse aid you can minimize the repeat buildup of white film.

Is the home water pressure high enough for proper dishwasher filling? Home water pressure should be 20 to 120 psi (138 to 828 kPa) for proper dishwasher fill. If you have questions about your water pressure, call a licensed, qualified plumber.

NOTE: To remove spots and film from glassware, remove all silverware and metal items and run a vinegar rinse as described in “Dishwasher Care.”

- **Silica film or etching (silica film is a milky, rainbow-colored deposit; etching is a cloudy film)**

Sometimes there is a water/chemical reaction with certain types of glassware. This is usually caused by some combination of soft or softened water, alkaline washing solutions, insufficient rinsing, overloading the dishwasher, and the heat of drying. It might not be possible to avoid the problem, except by hand washing.

To slow this process use a minimum amount of detergent but not less than 1 tbs (15 g) per load. Use a liquid rinse aid and underload the dishwasher to allow thorough rinsing. Silica film and etching are permanent and cannot be removed. Do not use heated drying.

- **White spots on cookware with a nonstick finish**

Has the dishwasher detergent removed the cookware seasoning? Reseason cookware after washing it in the dishwasher.

- **Brown stains on dishes and dishwasher interior**

Does your water have high iron content? Rewash dishes using 1 to 3 tsp (5 to 15 mL) of citric acid crystals added to the covered section of the detergent dispenser. Do not use detergent. Follow with a Normal wash cycle with detergent. If treatment is needed more often than every other month, the installation of an iron removal unit is suggested.

- **Black or gray marks on dishes**

Are aluminum items rubbing dishes during washing? Disposable aluminum items can break down in the dishwasher and cause marking. Hand washes these items. Remove aluminum markings by using a mild abrasive cleaner.

- **Orange stains on plastic dishes or dishwasher interior**

Are large amounts of tomato-based foods on dishes placed in the dishwasher? It may be necessary to use a stain removal product to remove stains from your dishwasher. Stains will not affect dishwasher performance.

Noises

- **Surging sounds:** Surging sounds can occur periodically throughout the cycle while the dishwasher is draining.
- **Valve hissing:** Normal water valve hissing may be heard periodically, during the water fill.

- **Snapping sound:** A normal snap sound may be heard when the detergent dispenser opens during the cycle, and when the door is opened at the end of the cycle.
- **Grinding, grating, crunching, or buzzing sounds:** A hard object has entered the wash module (on some models). When the object is ground up, the sound should stop. If the noise persists after a complete cycle, call for service

Dishwasher stops and starts

- **Numerous starts and stops**

It is normal to hear numerous starts and stops throughout your entire cycle. These starts and stops are needed to provide optimal cleaning performance and energy savings.

- **Depending on the cycle selected**

Depending on the cycle selected and the soil level sensed by the Optical Water Sensor (on some models), you will experience more starts and stops throughout the entire cycle.

Dishes are not completely clean

- **Food soil left on the dishes**

Is the dishwasher loaded correctly?

Check and clean your filters regularly. See the table in the “Filtration System” section for “Recommended Time Interval to Clean Your Filter.”

Did you choose the cycle that describes the most difficult soil in your dishwasher? If you have some items with heavier soils, use a heavier cycle.

Is the water temperature too low? For best dishwashing results, water should be 120°F (49°C) as it enters the dishwasher.

Did you use the correct amount of fresh detergent? Use recommended dishwasher detergents only. Do not use less than 1 tbs (15 g) per load. The detergent must be fresh to be effective. Heavy soil and/or hard water generally require extra detergent.

Is detergent caked in the dispenser? Use fresh detergent only. Do not allow detergent to sit for several hours in a wet dispenser. Clean dispenser when caked detergent is present. Is the pump or spray arm clogged by labels from bottles and cans?

Is the home water pressure high enough for proper dishwasher filling? Home water pressure should be 20 to 120 psi (138 to 828 kPa) for proper dishwasher fill. If you have questions about your water pressure, call a licensed, qualified plumber.

Are high suds slowing the wash arm? Do not use soap or laundry detergents. Use recommended dishwasher detergents only.

- **Dishes in the Target Clean™ wash area are not clean**

Are the dishes loaded to face the Target Clean™ spray jets? Load soiled dish surfaces to face the back of the dishwasher toward the Target Clean™ spray jets. Tilt the dishes toward the back, so water can drain from surfaces and the lower spray arm can wash the item from below.

NOTE: Loaded items may shift when dish racks are pushed into the dishwasher. Make sure dishes do not interfere with the spray arms, water feed tube, or Target Clean™ spray jets. Are items loaded so they do not overlap? Load items only one row deep without any overlap so that the Target Clean™ spray jets can reach all surfaces.

Dishes are damaged during a cycle

- **Chipping of dishes:** Did you load the dishwasher properly? Load the dishes and glasses so they are stable and do not strike together from washing action. Minimize chipping by moving the rack in and out slowly.

NOTE: Antiques, feather-edged crystals, and similar types of china and glassware might be too delicate for automatic dishwashing. Wash by hand.

Warning

This content is compiled from multiple sources and is provided for reference purposes only. It may not be complete or fully applicable to all situations. If you are unable to resolve your issue, please contact the product manufacturer or an authorized service provider for official support.