

Product Diagram

Robot

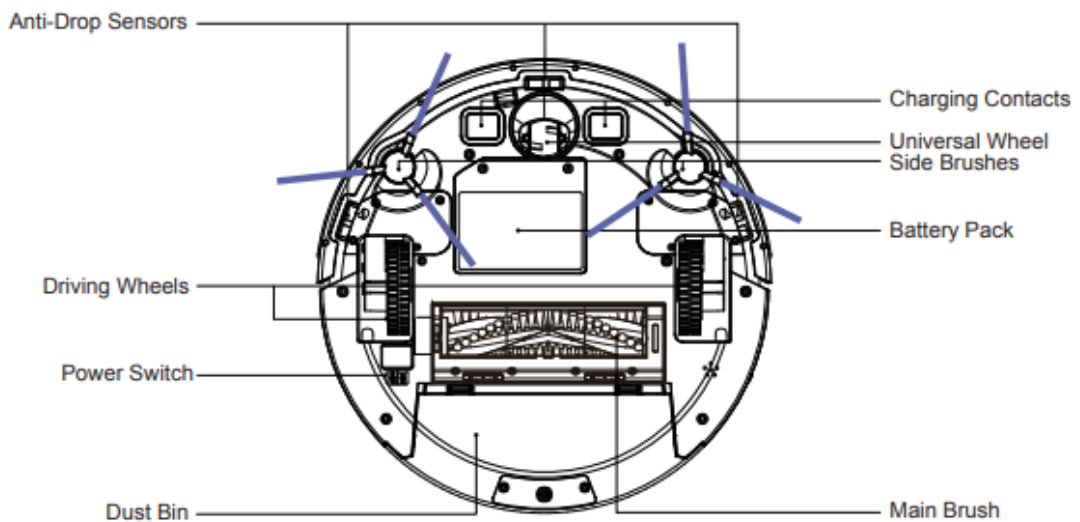

Charging Dock

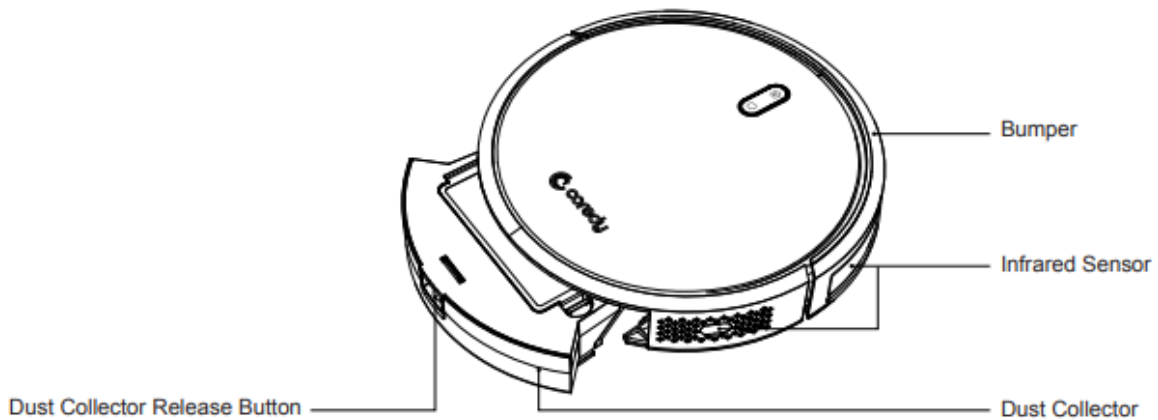
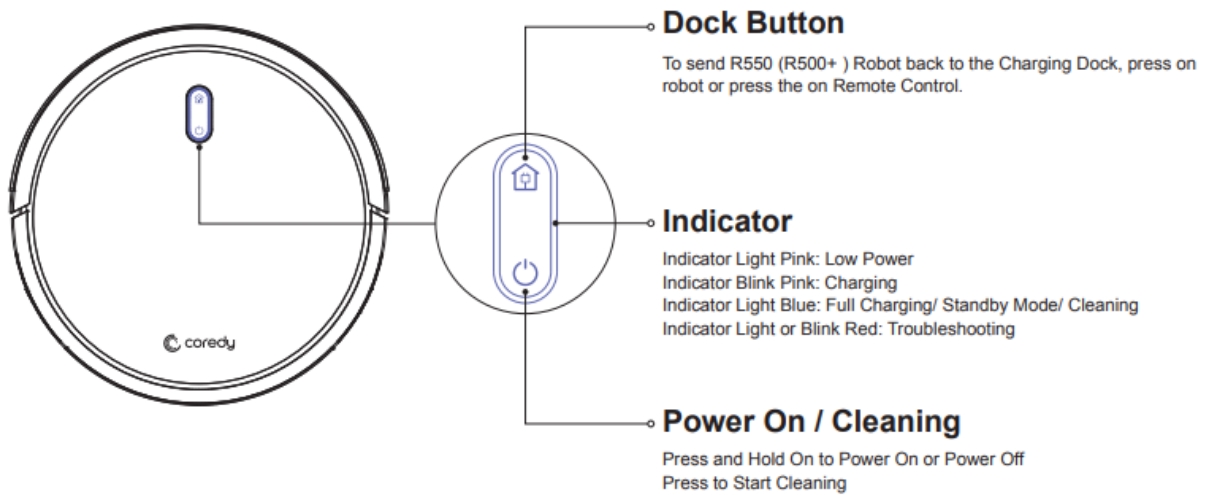
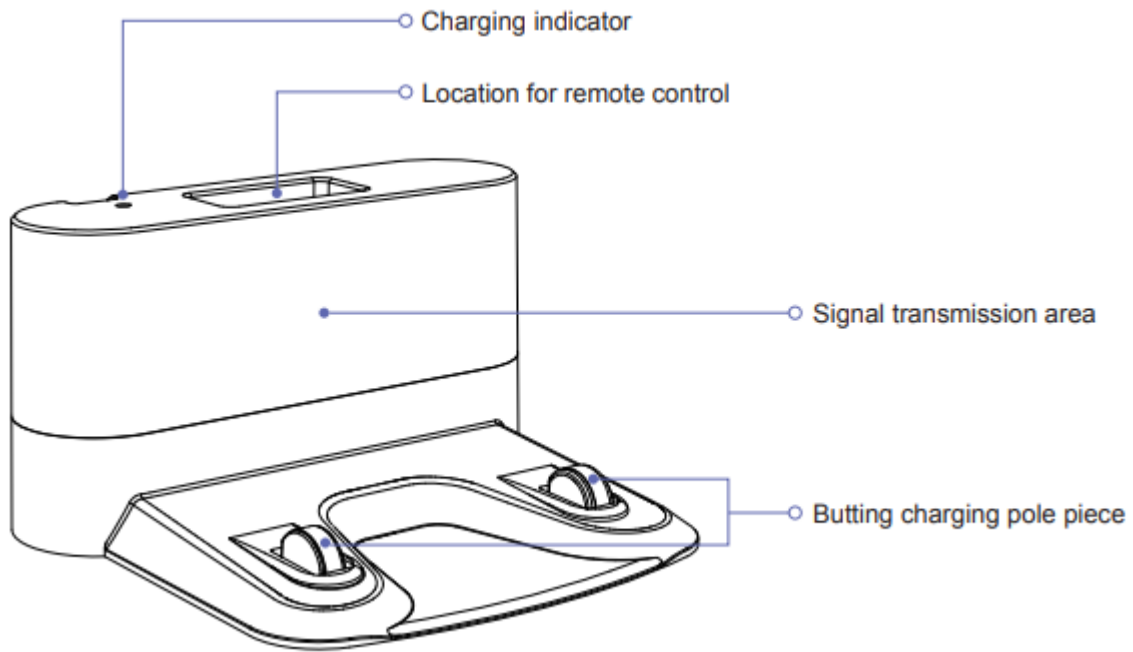

Remote Control

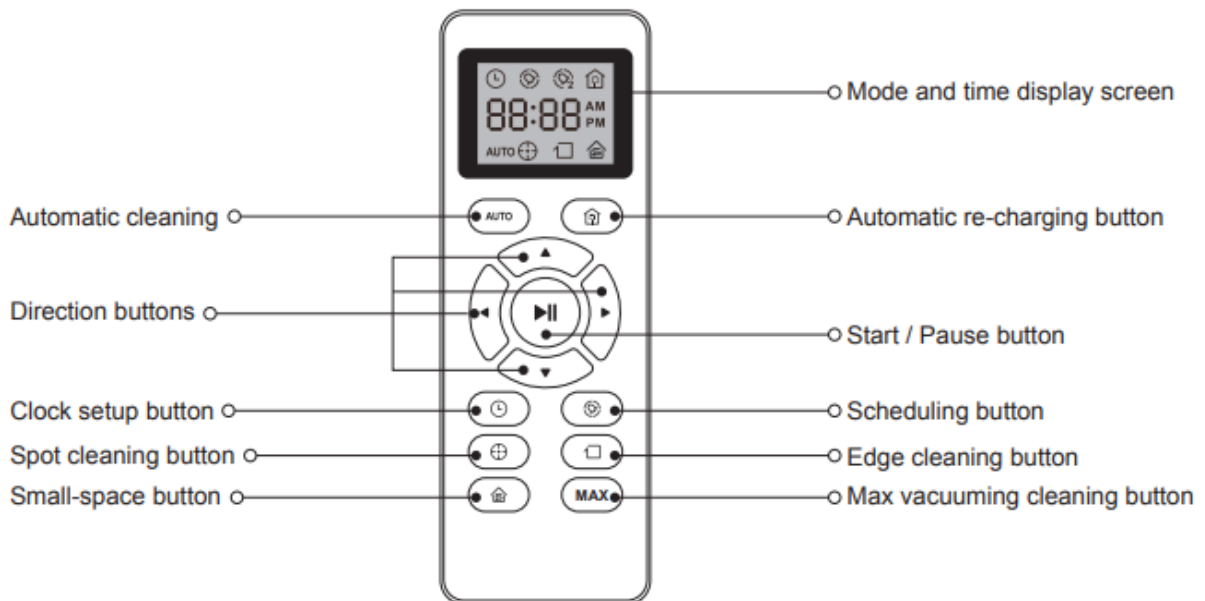

Operating and Programming

Notes Before Cleaning

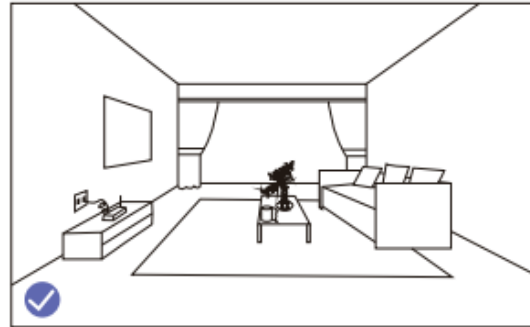
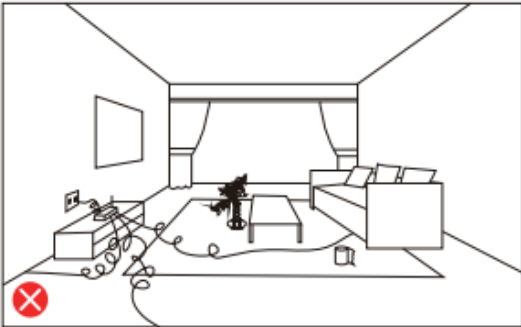

Before using Robot, pick up objects like clothing, loose papers, pull cords for blinds or curtains, power cords, and any fragile objects. If the Robot passes over a power cord and drags it, there is a chance an object could be pulled off a table or shelf.

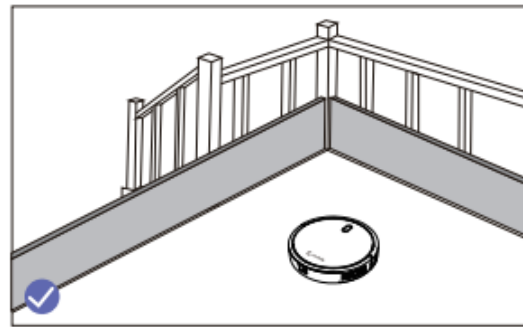
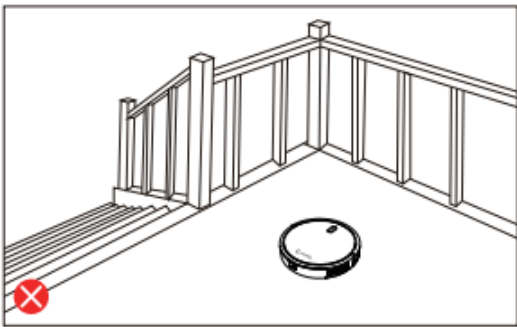

If the room to be cleaned contains a balcony, a physical barrier should be used to prevent access to the balcony and ensure safe operation.

Quick Start

1. Plug in the Charging Dock and place the remaining wire into the trunking at the bottom of the Charging Dock

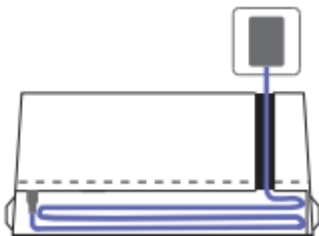

2. Place the Charging Dock on a hard level surface and against a wall.



3. Charging Dock Position

Place the Charging Dock against the wall and make sure it is in an open and uncluttered area leaving at least

- 2 meters (6 feet) in the front of the Charging Dock.
- 1 meter (3 feet) on both sides of the Charging Dock.

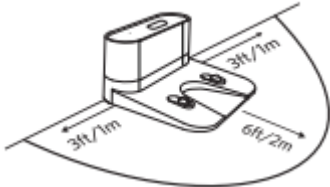

4. Install Side Brushes

Attach Side Brushes to the bottom of Coredy R550 (R500+) by pressing a brush into each slot until it clicks.

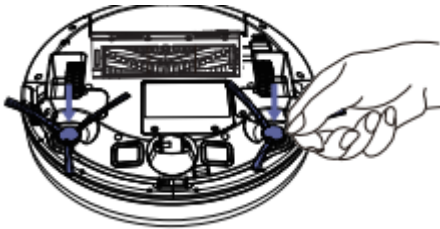



5. Activate the Robot

Place Coredy R550 (R500+) onto the Charging Dock, making sure the metal charging contacts on the Charging Dock match up with those underneath the robot.

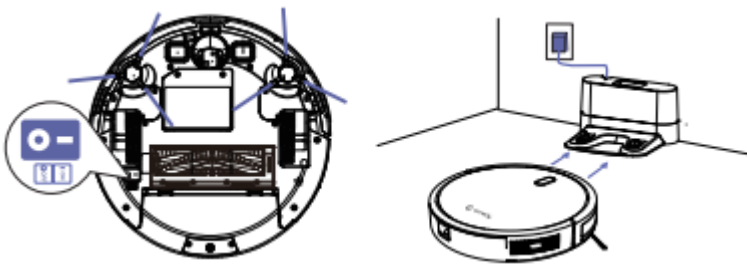
If successful, you will hear a series of tones. Once the  Power button illuminates, Coredy R550 (R500+) is ready for use.



6. Start Cleaning Cycle



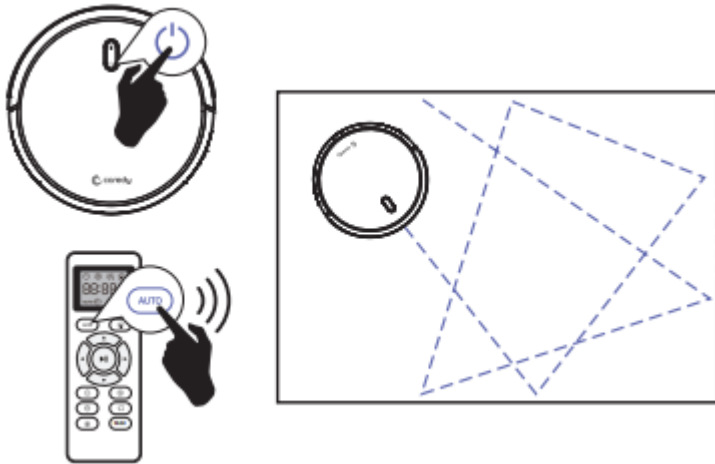

- Press the  power button once to wake up the robot.
- Press the  power button again to start a cleaning cycle (or  button on Remote Control).

If its battery gets low before finishing a cleaning cycle, robot returns to the Charging Dock to recharge.

If the Charging Dock is inaccessible, Robot will not be able to recharge, please place the robot manually on Charging Dock for charging. (Refer Activate the Robot)



7. Pause

- To pause the robot during a cleaning cycle press the  button on robot or press the  button on the Remote Control.
- To resume the cleaning cycle, press  button again.
- To send robot back to the Charging Dock, press  button.

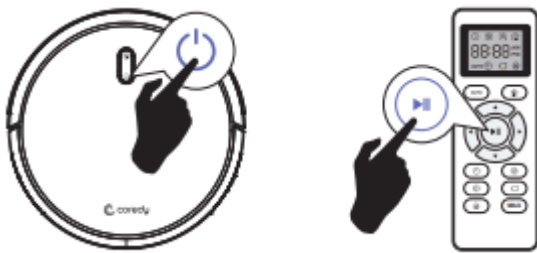

8. Power OFF

- To end the cleaning cycle and put robot in standby mode, press and hold  button until robot's indicators turn off.



How Coredy R550 Clean Your Home

Coredy R550 (R500+) continues this process until it has cleaned an entire level of your home. If its battery gets low before finishing a cleaning cycle, Coredy R550 (R500+) returns to the Charging Dock to recharge.

1. Auto Cleaning

- Working in random pattern for seamlessly and thoroughly clean.
- At various times throughout the cleaning cycle, Coredy R550 (R500+) touches up around the edges of the room, as well as chair legs and other furniture.
- Coredy R550 (R500+) continues this process until it has cleaned an entire level of your home. If its battery gets low before finishing a cleaning cycle, Coredy R550 (R500+) returns to the Charging Dock to recharge.
- Once Coredy R550 (R500+) finishes its cleaning cycle, Coredy R550 (R500+) returns to the Charging Dock to recharge.

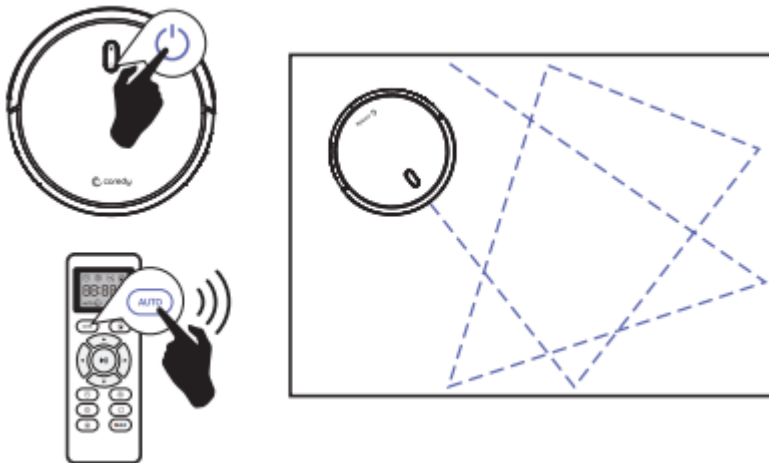

2. Floor Mopping Cleaning

Coredy R550 (R500+) support wet mopping function (Required a water tank,you can shop on <http://shop.coredy.com>) the robot can floor mops cleaning for your home.

1. Attach the cloth and fill the water tank with water

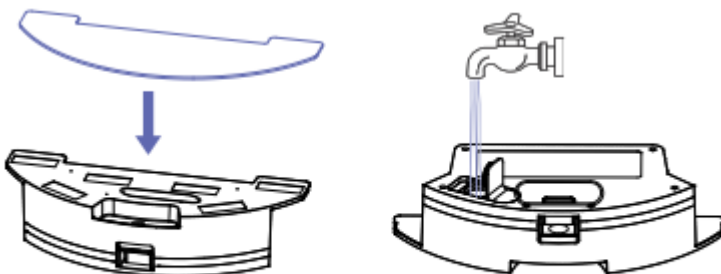

Water Tank and Cleaning Cloth (Sold Separately)

2. Remove the dust bin

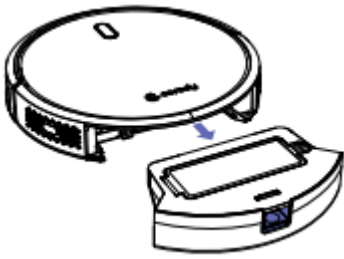

3. Put back the water tank to robot and start the Robot.

Cleaning Preferences

3. Spot Cleaning

When you select Spot Cleaning, robot intensely cleans a localized area by spiraling outward about 3 feet (1 meter) in diameter and then spiraling inward to where it started. When Spot Cleaning, robot boosts its vacuum power to provide the best cleaning possible where you need it. To use Spot Cleaning, place robot on top of the localized debris and press  (Spot) on the Remote Control

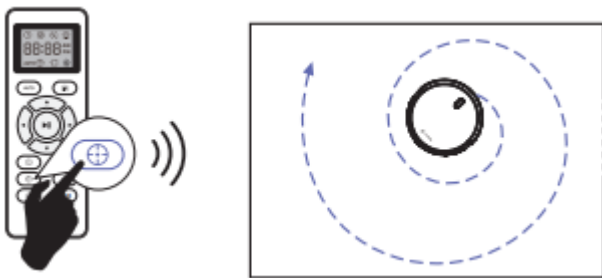

4. Max Vacuuming Cleaning

Robot increases its vacuum power to provide a deeper clean when press the  button on Remote Control, Max Vacuuming Cleaning is Off by default.

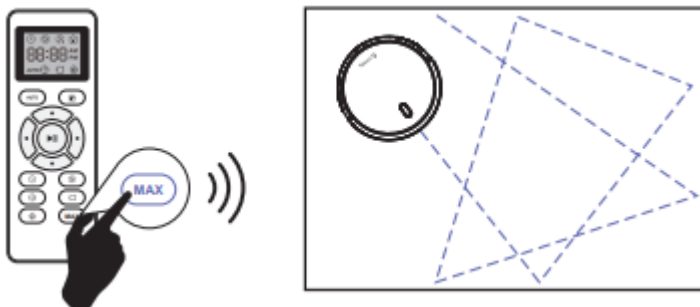

5. Edge Cleaning

After robot finishes cleaning the open areas of your floor, it uses Edge Clean to ensure that it has cleaned along walls and around furniture legs. If you prefer a quicker edge cleaning, press the  button on Remote Control.

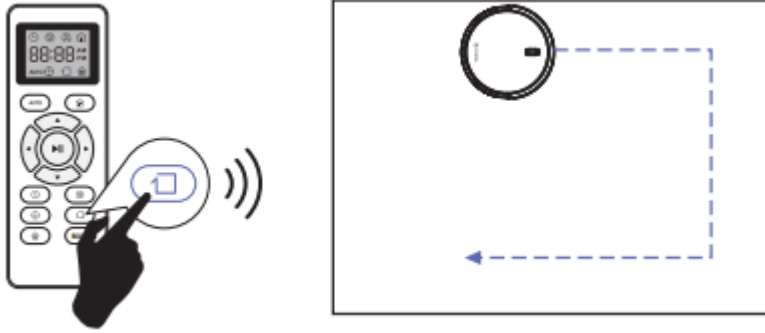

6. Single Room Cleaning

Coredy R550 (R500+) intensively cleans one single room and stops after 30 minutes. Select this mode only when one specific room needs to be cleaned. Make sure to confine Coredy R550 (R500+) to the room by closing the door. Press  on the remote control to start cleaning in Single Room Mode.

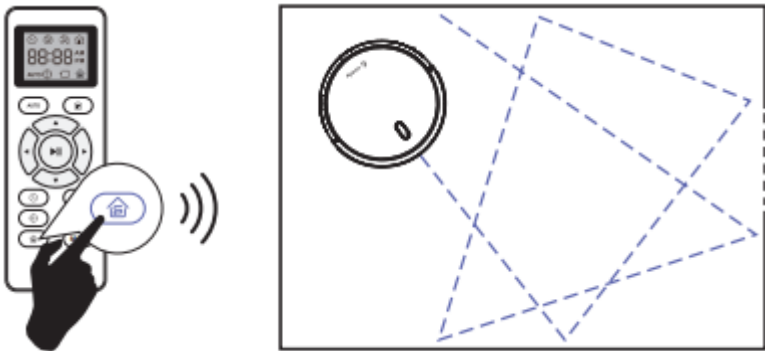

7. Manual Cleaning

You can direct Coredy R550 (R500+) to clean a particular area by using the directional buttons on the remote control.

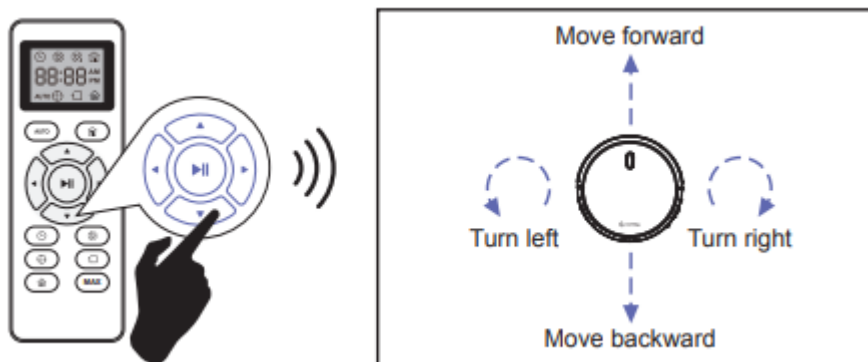

8. Use the Boundary Strip (Sold Separately)

With the Boundary Strip, you can keep Coredy R550 (R500+) away from any area or item you do not want Coredy R550 (R500+) to clean. Coredy R550 (R500+) will recognize the Boundary Strip and will not cross into the blocked-off area.

1. Identify the area or item you do not want Coredy R550 (R500+) to get close to.
2. If necessary, use scissors to cut the Boundary Strip to a shorter length. Be sure to correctly measure the length before cutting.

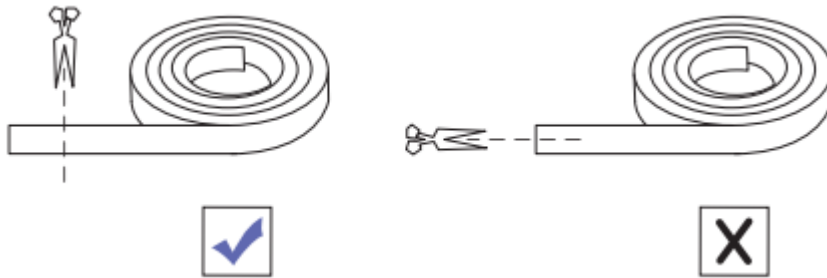

3. Apply adhesive tape to lay the Boundary Strip flat on the floor. Make sure the strip is placed FLAT on the floor.

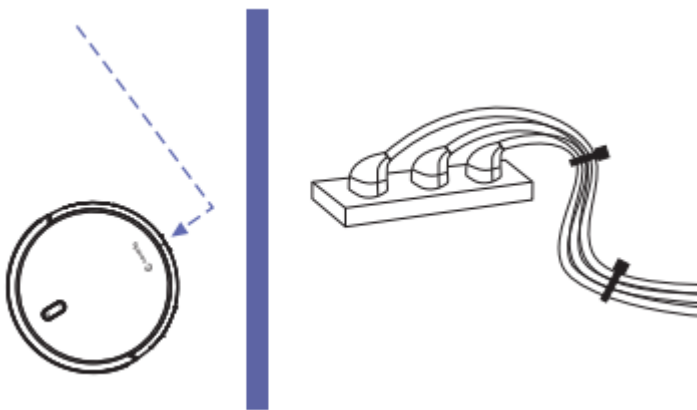

Note: If the Boundary Strip is rolled up, remove and then re-apply on the floor with adhesive tape. Otherwise the Boundary Strip may not work well. Make sure the Boundary Strip is placed on the same surface plane Coredy R550 (R500+) is used on. Be careful not to damage the floor when using adhesive tape. It is not recommended for use on carpets. Keep the Boundary Strip away from objects that emit excessive heat.

Cleaning Schedule

Coredy R550 (R500+) has cleaning schedule settings which allow you to customize when Robot cleans your home. These settings are available only through the Remote Control.

Note:



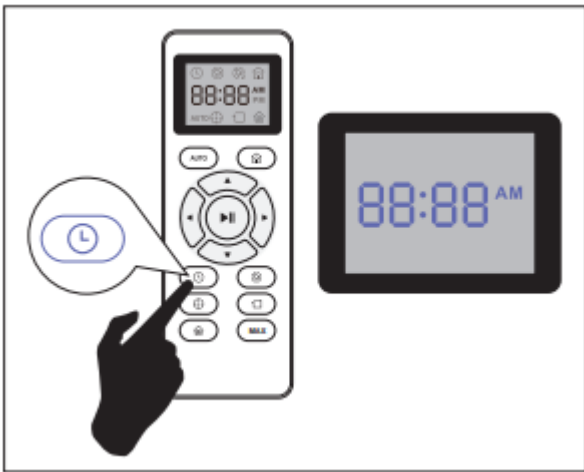

1. Make sure the time is set correctly to your local time before setting a cleaning schedule.
2. Make sure AM/PM is set correctly.
3. Schedule accuracy is every 15 minutes.
4. Make sure the remote control near by the robot while setting the clock or schedule.

1. Set the Remote Control's Clock

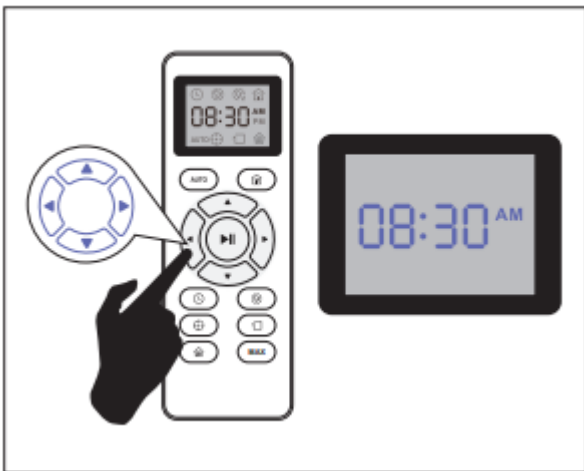

Press  button on Remote Control, and then the hour section begins to flash in the clock display setting window





Press  or  button to select the desired figures. Press the  or  button to select the minute or hour section.





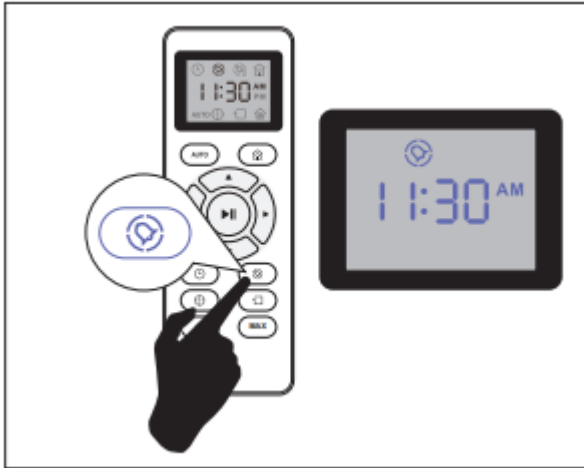

And then press the  button, the Robot will “BEEP” when the clock setting completed.

2. Setting Cleaning Schedule

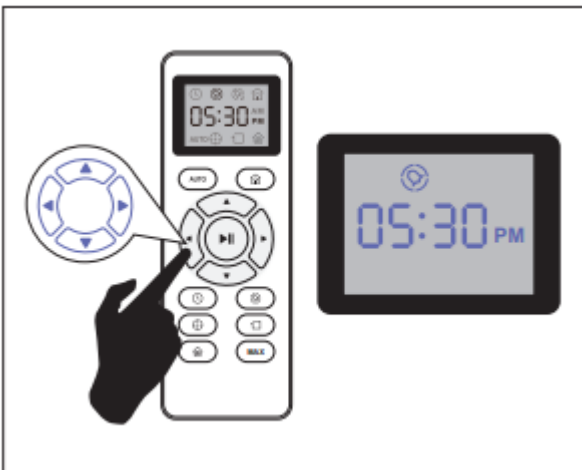

Press  button on Remote Control, and then the hour section begins to flash in the Cleaning Schedule display setting window.



Press  or  button to select the desired figures. Press the  or  button to select the minute or hour section.



And then press the  button, the Robot will “BEEP” when the Cleaning Schedule setting completed.

3. Cancel the Cleaning Schedule

Press and hold  button approximately 4 seconds on Remote Control, the Robot will “BEEP” when the Cleaning Schedule process cancel completely.

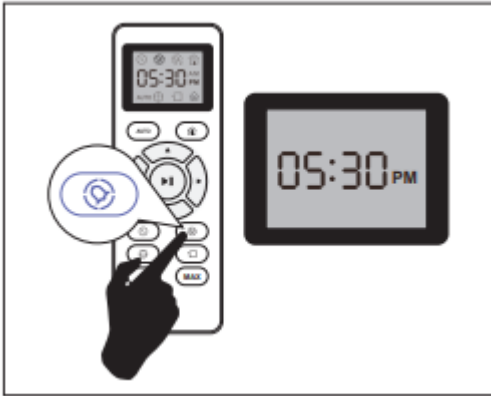

Regular Robot Care

To keep robot running at peak performance, perform the following care procedures. If you notice robot picks up less debris from your floor, then empty the bin, clean the filter and clean the rolling brush.

Robot Part	Care Frequency	Replacement Frequency
Filter	Once per week (twice per week in homes with pets)	Every 2 months
Cleaning Cloth (Sold Separately)	After each use	Every 2-4 months
Rolling Brush	Once every 4 months (once every 3 months in homes with pets)	Every 6-12 months
Dust Bin	After each use	—
Water Tank (Sold Separately)	After each use	—
Front Caster Wheel Side Brush Cliff Sensors Charging Contacts Floor Tracking Sensor	Once per month	—

Emptying Robot's Bin

1. Press dust bin release button to remove it

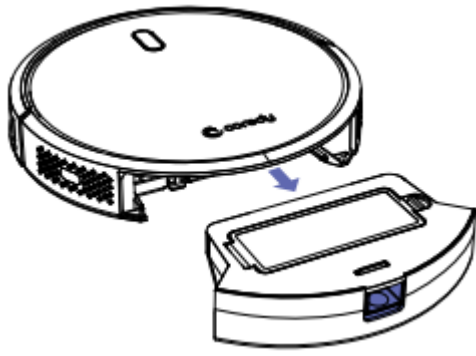

2. Open dust bin door to empty it.

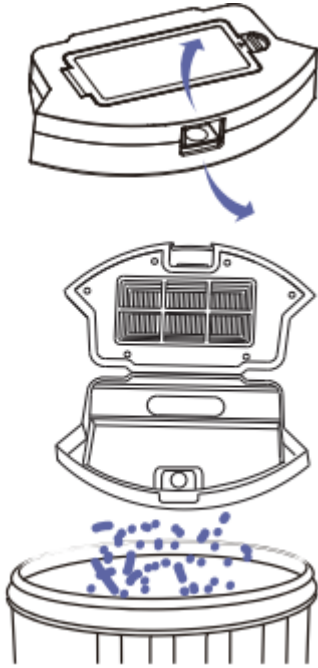

Cleaning Robot's Filter

1. Remove filter by grasping the white tab.

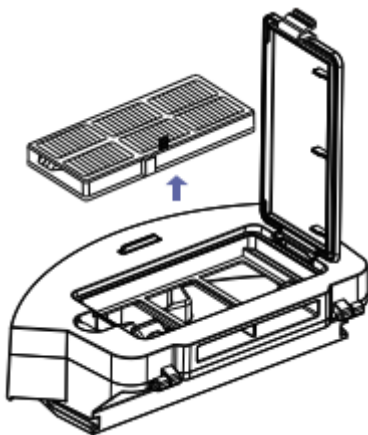

2. Shake off debris by tapping the filter against your trash container.



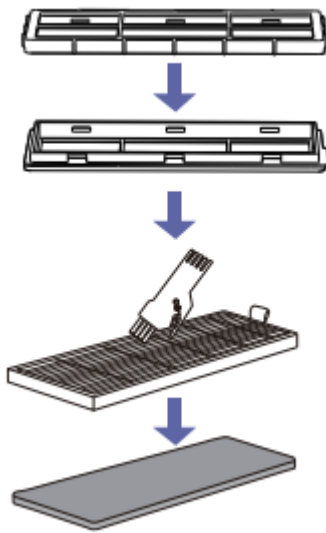

Cleaning Robot's Side Brush

1. Remove the brush
2. Clean the brush and the brush stand, and reinstall the brush.

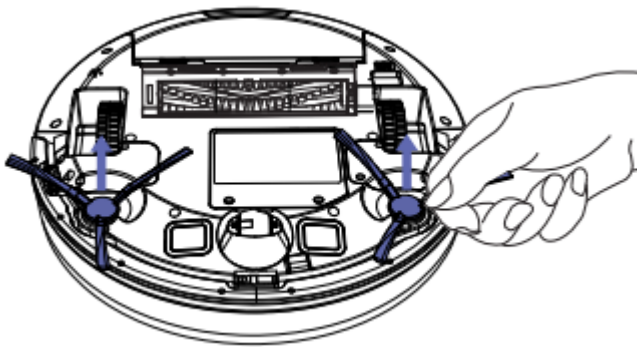

Cleaning Robot's Cliff Sensors and Charging Contacts

1. Wipe Robot's Cliff Sensors with a clean, dry cloth.

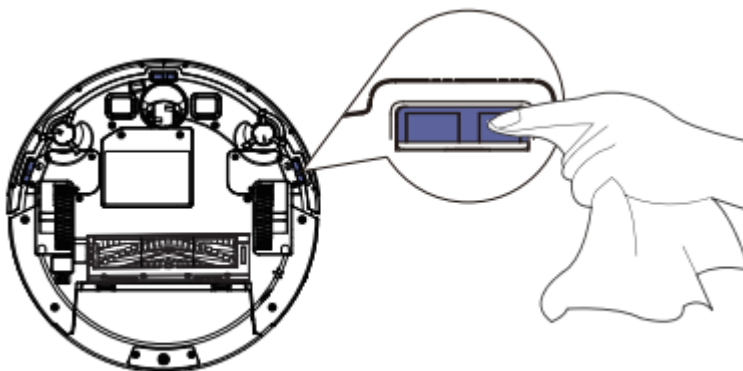

2. Wipe the charging contacts on Robot and the Charging Base with a clean, dry cloth.

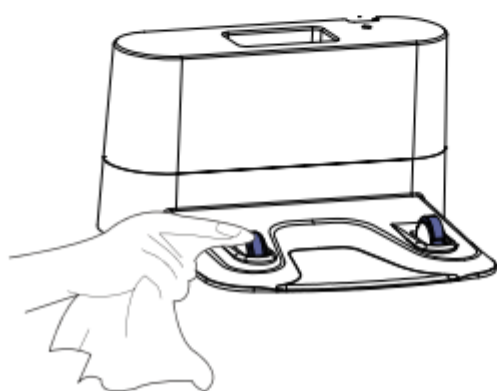
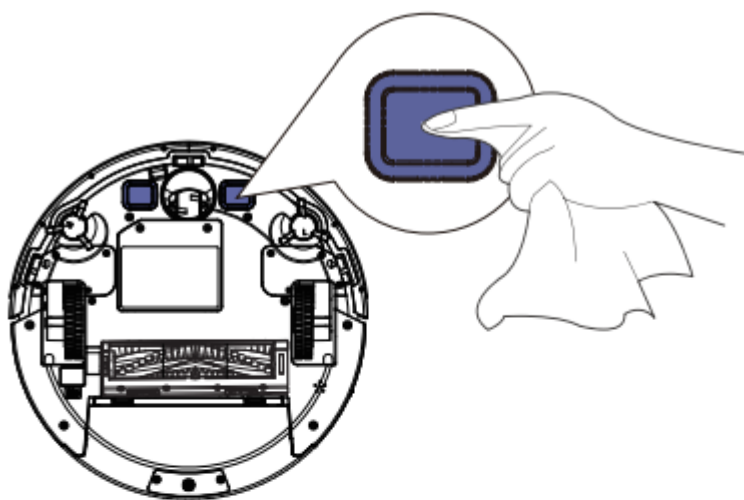

Cleaning Robot's Floor Tracking Sensor

Use a clean, dry microfiber or soft cotton cloth to wipe any debris that has accumulated in the round sensor opening on the right side of the bottom surface. Do not spray cleaning solution directly into the sensor entrance.



Cleaning Robot's Rolling Brush

1. Pull on the release tabs to unlock the brush guard as shown.

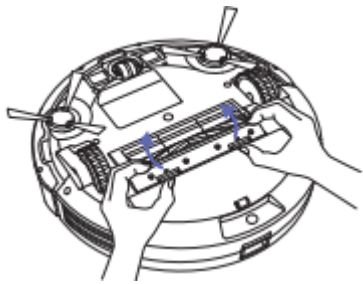

2. Lift the rolling brush to remove.

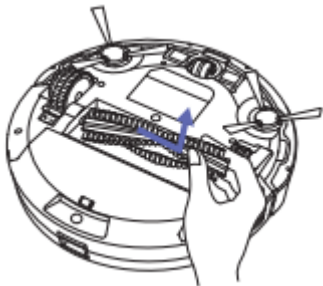

3. Clean the rolling brush with the provided cleaning tool or a vacuum cleaner.

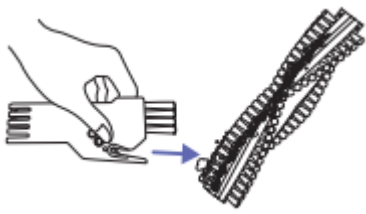

4. Reinstall the rolling brush by inserting the fixed protruding end first and then clicking into place.

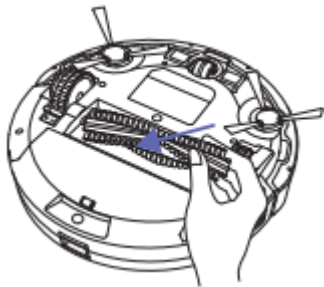

5. Press down to snap the brush guard into place.

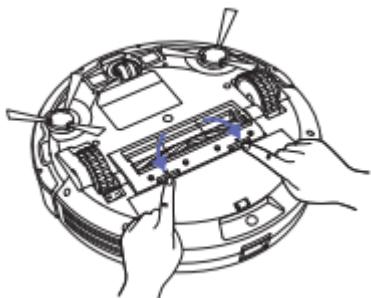

Battery and Charging Information

Lithium Ion Battery

Important: Lithium ion batteries and products that contain lithium ion batteries are subject to stringent transportation regulations.

If you need to ship this product (with the battery included) for service, travel or any other reason, you **MUST** comply with the following shipping instructions:

- Remove the lithium ion battery from the product
- Place a piece of tape over the battery's metal charging contacts
- Reinstall the battery (with the tape on it) in the product and secure the battery door
- Package the product in its original packaging or in your own packaging that prevents any movement during transportation
- Ship via ground transportation only (no air shipping)

Battery Charging

To extend battery life, always keep robot charged on the Home Base when not in use.

Battery Storage

If storing robot off of the Charging Dock, remove the battery first. Then store robot and the battery in a cool, dry place.

Battery Disposal

Contact your local waste management authority for battery recycling and disposal regulations in your area.

Battery Replacement

You can visit CoreDy's website to purchase the battery or other accessories for the robot.

Battery Removal

Follow these instructions to remove and reinstall robot's battery:

1. Unscrew the door and the two screws on the battery door, then remove.

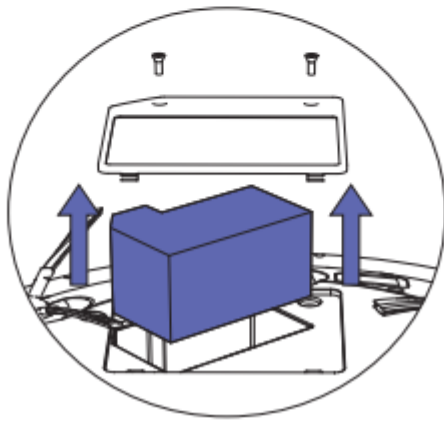
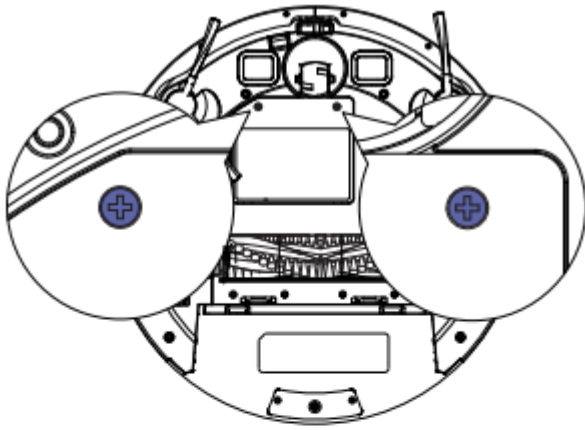

2. Reinstall the battery with the battery label and tabs facing up.

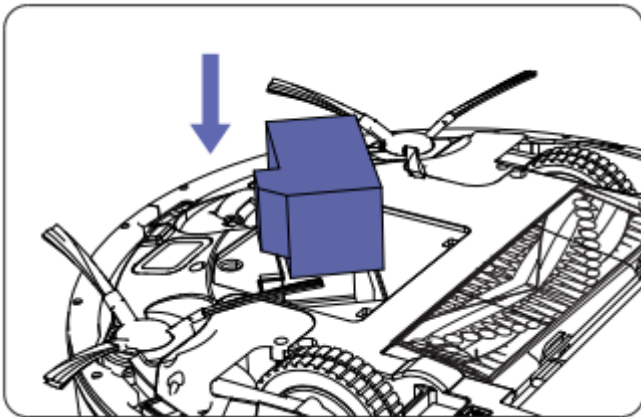

3. Reinstall the battery door and the two screws. Take care not to pinch the side brush in the battery door when re-installing the battery

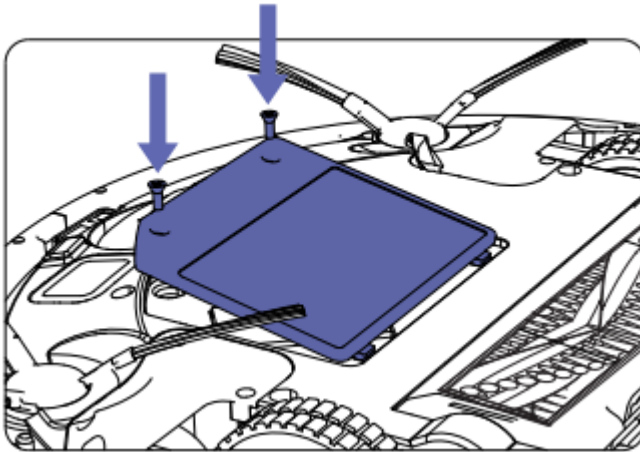

Troubleshooting

Robot will tell you something is wrong with a two-tone distress sound followed by message. The indicator  will also blink or lit red. Refer to the chart as below to resolve Robot's problem. If the problem is not resolved, please contact our COST FREE customer service team for more assistance

Rebooting Instructions

For some errors, rebooting Robot may resolve the problem. To reboot Robot, press the power button on the bottom on Robot, you will hear an audible tone signifying a successful reboot.

Indicator Lighting Red

Robot Blinks and Says		Likely Cause	What to Do
Indicator Lighting Red	One beep	Robot's front driving wheel is stuck.	Clean the front driving wheel, then press the power button to restart the robot.
	Two beeps	Robot's side brush is stuck.	Clean the side brush, then press the power button to restart the robot.
	Three beeps	Robot's vacuum fan is stuck or its filter is clogged.	<ul style="list-style-type: none"> • Remove and empty robot's dust bin. • Clean robot's filter, then briskly tap the bin to loosen any remaining trapped debris. • Make sure the vacuum inlet is not blocked by any hair or debris
	Four beeps	Robot's main rolling brush is stuck.	Remove and clean the main rolling brush and brush guard, then press the power button to restart the robot.

Indicator Flashing Red

Robot Blinks and Says		Likely Cause	What to Do
Indicator Flashing Red	Two beeps	Robot's bumper is stuck.	If Robot is stuck, free it and start in a new location. Clean Robot's side wheels of hair and debris. Push the wheels in and out, and check that they both turn freely
	One beep	<ul style="list-style-type: none"> • Robot is stuck and one of the wheels is not making contact with the floor(hanging in mid-air). • Robot may be in an extremely large room and the bumper is not registering obstacles. 	Restart cleaning in a new location.
	Three beeps	Robot's cliff sensors are dirty, it is hanging over a drop, or it is stuck on a dark surface.	If Robot is hanging over a drop, or on a dark surface, start in a new location. Otherwise, wipe its cliff sensors with a dry cloth.
	Four beeps	Robot cannot return to its Charging Dock or starting position.	Ensure there are no obstacles in front of the Charging Dock or starting position. Wipe the Charging contacts on both the Charging Dock and robot with a clean, dry cloth.

Frequently asked questions





Problems	Solutions
Coredy R550 (R500+) cannot be activated.	<ul style="list-style-type: none"> • Make sure the main power switch is in the ON position. • Make sure the battery is fully charged. • Replace the batteries (2 AAA) in the remote control. • Make sure the remote control is within range (16 ft/5 m) of Coredy R550 (R500+). • If you still have trouble, turn off the main power switch and then turn it back on.
The remote control does not work.	<ul style="list-style-type: none"> • Replace the batteries in the remote control. • Make sure Coredy R550 (R500+) is turned on and fully charged. Note: Limited workable range distance is 5m/16.5ft.
Coredy R550 (R500+) stops working suddenly	<ul style="list-style-type: none"> • Check if Coredy R550 (R500+) is trapped or stuck on an obstacle. • Check if the battery level is too low. • If you still have trouble, turn off the main power switch, wait for 2 seconds, and then turn it back on.
You cannot schedule cleanings.	<ul style="list-style-type: none"> • Make sure the main power switch on the bottom of Coredy R550 (R500+) is turned on. • Make sure the time, time of day (AM/PM), and the scheduled time have been set correctly. • Check if Coredy R550 (R500+)'s power is too low to start cleaning.
Suction power is weak.	<ul style="list-style-type: none"> • Check if any obstructions are blocking the suction inlet. • Empty the dust collector. • Clean the filters with a vacuum cleaner or a cleaning brush. • Check if the filters are wet due to water or other liquid on the floor. Air-dry the filters completely before use





Problems	Solutions
Coredy R550 (R500+) cannot be charged.	<ul style="list-style-type: none"> • Check if the indicator on the Charging Base lights up. If not, contact the Coredy service center to repair or replace the Charging Base. • Dust off the charging contact pins with a dry cloth. • Check if you can hear a beep when Coredy R550 (R500+) is docked onto the Charging Base. If not, contact the Coredy service center to repair or replace the Charging Base.
Coredy R550 (R500+) cannot return to the Charging Base.	<ul style="list-style-type: none"> • Remove objects within 3 ft/1 m to the left and right side and within 6 ft/2 m of the front of the Charging Base. • When Coredy R550 (R500+) is in the vicinity of the Charging Base (distance within 26ft/8M) , it returns more quickly. However, if the Charging Base is located far away (distance over 26ft/8M) , Coredy R550 (R500+) needs more time to return. Please be patient as it walks back. \Clean the charging contact pins.
The rolling brush does not rotate.	<ul style="list-style-type: none"> • Clean the rolling brush. • Check if the rolling brush and brush guard have been installed properly
Coredy R550 (R500+)'s movements or travel path are abnormal.	<ul style="list-style-type: none"> • Clean the sensors carefully with a dry cloth. • Restart Coredy R550 (R500+) by turning the power switch off and on.



Specifications

	Product Model	R550 (R500+)
	Input	19 V  0.6 A
	Battery Voltage	DC 14.4 V
	Power Consumption	28 W
	Battery Type	DC 14.4 V Li-ion 2600 mAh
	Dust Collector Capacity	0.5 L
	Cleaning Time	Max. 120 mins
	Charging Time	300 - 360 mins

	Input	19 V  0.6 A
	Output	19 V  0.6 A

Warning

This content is compiled from multiple sources and is provided for reference purposes only. It may not be complete or fully applicable to all situations. If you are unable to resolve your issue, please contact the product manufacturer or an authorized service provider for official support.