

CONTROL PANEL AND FEATURES

NOTES:

- Not all features and cycles are on all models.
- If your model has a touch interface, the control panel features a sensitive surface that responds to a light touch of your finger. To ensure your selections are registered, touch the control panel with your fingertip, not your fingernail. When selecting a setting or option, simply touch its name.
- If your model has physical buttons, make sure to press the button firmly.
- At cycle completion, your setting and option choices will be remembered for the next cycle. However, if power to the washer is lost, the settings and options will go back to the factory defaults.

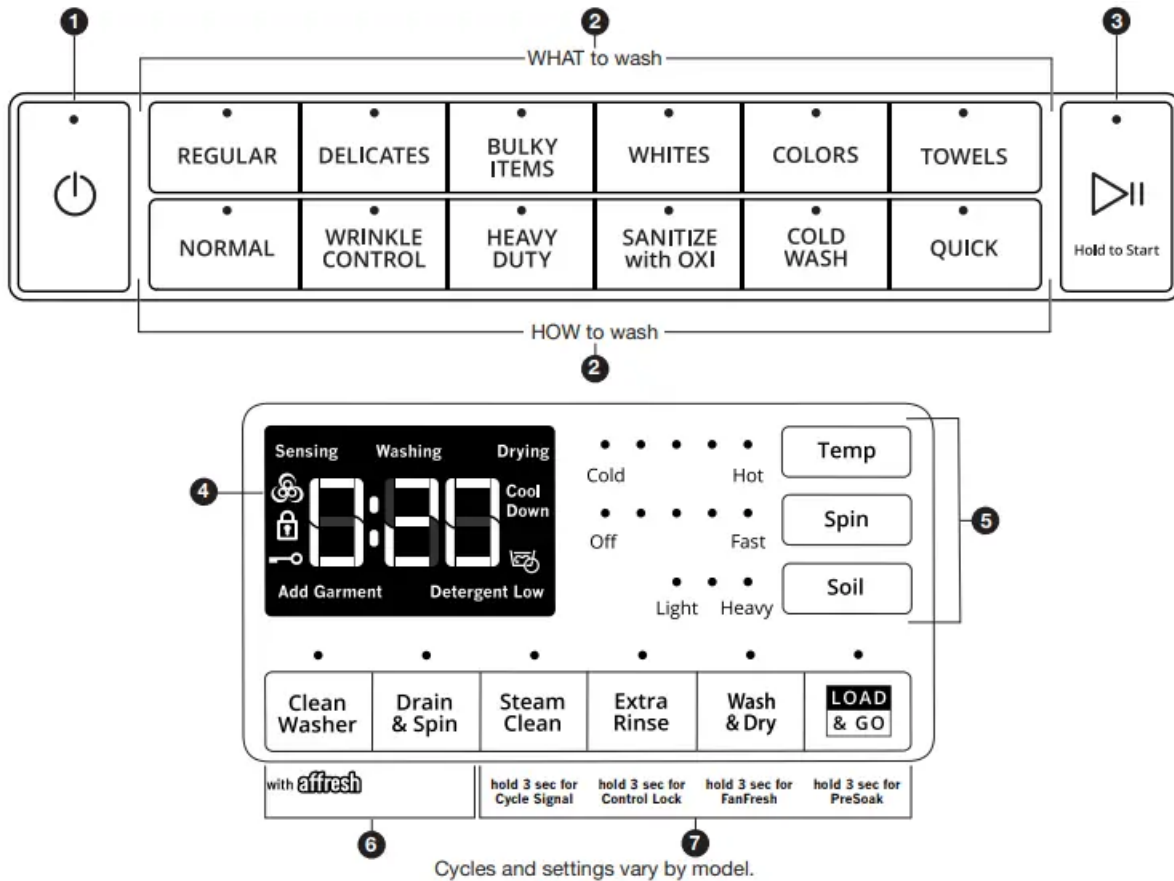

1 POWER

Select to turn the washer on and off. Select to stop/cancel a cycle at any time.

2 WHAT TO WASH/HOW TO WASH

First determine what items are in the load that you are trying to wash. Use that to guide your “What to Wash” selection.



Then determine how you want the washer to wash them and make the appropriate “How to Wash” selection. See “Cycle Guide” for cycle details. If you do not make a “How to Wash” selection, the washer will automatically select the recommended or last-used “How to Wash” cycle.

3 START/PAUSE

Touch and hold for 3 seconds until the light above Start/Pause comes on to start a cycle, or touch once while a cycle is in process to pause it.

4 CYCLE STATUS DISPLAY

The Cycle Status Display shows the progress of a cycle. At each stage of the process, you may notice sounds or pauses that are different from traditional washers.

Estimated Time Remaining

The Estimated Time Remaining shows the time required for the cycle to complete. Factors such as load size, modifiers, options selected, and water pressure may affect the time shown in the display. Tightly packed loads, unbalanced loads, or excessive suds may cause the washer to lengthen the cycle time as well.

Sensing

When Start/Pause is touched the washer will chime, indicating it is starting. The drum will make a partial turn. The door will click when it locks.

Once the door has locked, the washer will begin spinning to sense the load size. This sensing process will continue throughout the cycle.

After the load size is sensed, the estimated time based on load size will be displayed and water will be added. You may hear water flowing through the dispenser, adding detergent to the load. The actual cycle time may be lengthened; however, the display will continue to show the estimated time.

Washing

During the wash cycle, this will display to let you know the cycle is in progress.

Drying (on some models)

During a drying cycle, this will display to let you know the drying cycle is in progress.

Cool Down (on some models)

At the end of a drying cycle, your load will go through a cool-down period.

PreSoak



This symbol will be displayed to let you know a presoak is in progress.

Detergent Low (on some models)

When detergent in the bulk dispenser is running low, the display will show the detergent level (Low).

Add Garment

When “Add Garment” is displayed, you may pause the washer, open the door, and add items. Touch and hold START/PAUSE to start the washer again.

Door Locked

The Door Locked symbol will display to indicate that the door is locked and cannot be opened without first pausing or canceling the cycle.

Control Lock

When the Control Lock symbol is displayed, the buttons are disabled. Touch and hold EXTRA RINSE for 3 seconds to enable the buttons.

FanFresh® (on some models)

This symbol will be displayed when the FanFresh® option is activated. The fan will turn on and the load will tumble periodically for up to 12 hours.

End

Once the cycle is complete, “End” will display. Remove the load promptly for best results.

5 CYCLE MODIFIERS

When you select a cycle, its default settings will light up. Touch to adjust cycle modifiers on the washer before touching START/PAUSE. Additional wash modifiers or options selected after touching Start/Pause may not activate.

Once a wash setting is selected, it is saved for the cycle selected. To return to factory default cycle settings, unplug washer for 30 seconds; then plug back in. See “Cycle Guide” for default cycle settings.

NOTE: Some modifiers may increase or decrease the estimated time remaining.

Temp

The recommended wash temperature is preset for each cycle. Some preset temperatures can be changed. You may select a different wash temperature based on the level of soil and type of fabric being washed. For best results, use the warmest wash water safe for your fabric, following the garment label instructions. All wash temperatures feature a cold rinse.

Spin

The recommended spin speed is preset for each cycle. Some preset speeds can be changed.

- Faster spin speeds mean shorter dry times, but may increase wrinkling in your load.
- Slower spin speeds reduce wrinkling, but will leave your load more damp.

Soil

The recommended soil level is preset for each cycle. Some preset soil levels can be changed. For heavily soiled and sturdy fabrics, select the Heavy Soil Level setting. For lightly soiled and delicate fabrics, select the Light Soil Level setting. Lower soil level settings will help reduce tangling and wrinkling. hold 3 sec for

6 UTILITY CYCLES

Clean Washer

Use this every 30 washes to keep the inside of your washer fresh and clean. This cycle uses a higher water level. Use with affresh® Washer Cleaner tablets or liquid chlorine bleach to thoroughly clean the inside of your washer. When using this cycle, the drum should be empty. This cycle should not be interrupted. See the “Washer Care” section.

Drain & Spin

This cycle removes excess water from the load or special-care items washed by hand. Use this cycle after a power failure. For some fabrics, you may choose to set a slower spin speed. On some models: Touch and hold DRAIN & SPIN for 3 seconds to set a Dry Only cycle.

7 CYCLE OPTIONS

You may add or remove options for each cycle. Not all options can be used with all cycles, and some are preset to work with certain cycles. Options vary by model.

Steam Clean (on some models)

The Steam Clean option adds additional soak and wash time to many cycles to help remove tough stains, as well as a steam boost for added cleaning power. An integrated heater helps to maintain optimal wash temperatures. See “Cycle Guide” for cycles that allow the Steam Clean option.

You can also touch and hold STEAM CLEAN for 3 seconds to turn cycle signals on or off.

Extra Rinse

Activate this option to add an extra rinse to most cycles.

You can also touch and hold EXTRA RINSE for 3 seconds to disable/enable the Control Lock.

Wash & Dry (on some models)

Touch to add a drying cycle to your load after the wash cycle has finished. The Wash & Dry option is designed to wash and dry small loads overnight. Cycle time will vary based on load composition. For optimal dry performance and cycle time, load the drum no more than one-quarter full. The cycle will automatically terminate after a maximum 12-hour cycle time.

You can also touch and hold WASH & DRY for 3 seconds to activate/deactivate the FanFresh® option. Use the FanFresh® option if you will be unable to remove the load promptly. The washer will automatically activate the fan after the cycle ends and tumble the load periodically for up to 12 hours.

IMPORTANT:

- Do not use dryer sheets.
- Do not dry comforters or large blankets.

Load & Go™ (on some models)

Touch to select this option if you want to automatically add HE detergent to the wash load at the proper time.

IMPORTANT: When using the dispenser cartridge with concentrated liquid detergent, be sure to change the detergent concentration settings in the control if the detergent used is different than factory preset of 2x concentration. Change the detergent concentration setting by touching and holding TEMP and SOIL for 3 seconds.

You can also touch and hold LOAD & GO™ for 3 seconds to set a presoak.

PreSoak (on some models)

Touch to add a presoak time of your choice to a wash cycle.

8 DISPENSERS

Load & Go™ Bulk Dispenser (only on some models – varies by model)

The Load & Go™ bulk dispenser gives you the convenience of not having to add the HE detergent to the wash load every time. It also determines the best amount of detergent and the best time to add it to the load. See the “Using the Dispensers” section for information on using the dispenser drawer.

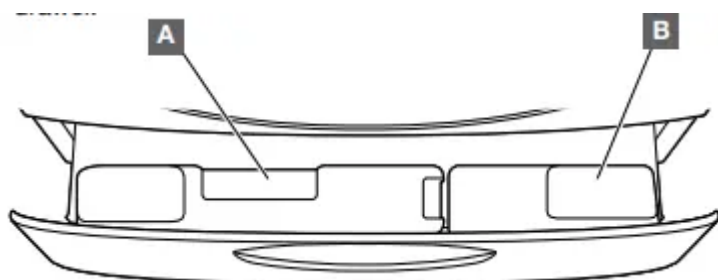

Washer comes with choice of a 1- or 2-liter bulk liquid detergent dispenser

Single Load Dispenser Drawer

The single load dispenser drawer gives you the convenience of adding HE detergent, liquid chlorine bleach, and liquid fabric softener to the wash load at the proper time. See the “Using the Dispensers” section for information on using the dispenser drawer.

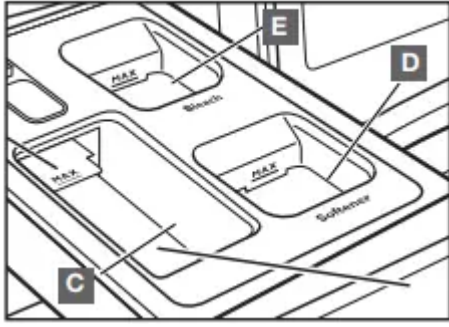

A 2-Liter Bulk Liquid High Efficiency (HE) detergent dispenser

This bulk dispenser holds up to 67.6 oz (2 L) of liquid HE detergent.

B 1-Liter Bulk Liquid High Efficiency (HE) detergent dispenser

This bulk dispenser holds up to 33.8 oz (1 L) of liquid HE detergent.

Each dispenser holds enough detergent for many loads of laundry. Each adds the appropriate quantity of HE detergent to the wash load at the proper time. See the “Using the Dispensers” section for information on using the dispenser.

IMPORTANT: Do not use chlorine bleach or powdered detergent in the bulk dispenser. Powdered detergent must be added to the single load dispenser. See the “Using the Washer” section.

C High Efficiency (HE) detergent compartment

This compartment holds liquid or powdered HE detergent for your main wash cycle, and automatically dispenses detergent in the cycle.

D Liquid fabric softener compartment

This compartment holds liquid fabric softener. It automatically dispenses liquid fabric softener at the optimum time in the cycle.

E Liquid chlorine bleach compartment

This compartment automatically dilutes and dispenses liquid chlorine bleach at the optimum time during the first rinse after the wash cycle. It cannot dilute powdered bleach.

CYCLE GUIDE

You can use this washer to wash only or to wash and dry. This washer has a unique user interface to help you select the best cycle for your load. The “What to Wash” “How to Wash” layout guides you to the optimal cycle in two easy steps:

First determine what items are in the load that you are trying to wash. Use that to guide your “What to Wash” selection. Then determine how you want the washer to wash them and select the appropriate “How to Wash” selection. Selecting “What to Wash” will automatically select a default “How to Wash selection,” so selecting a “How to Wash” is optional. See chart below for more details

What items Do You Want to Wash?	"What to Wash" Cycle Selection:
Cottons, linens, and mixed garment loads	Regular
No-iron fabrics, dress shirts/pants, synthetics, sheer/lacy garments	Delicates
Large items such as small comforters, sleeping bags, jackets, and washable rugs	Bulky Items
White fabrics/garments	Whites
Bright- or dark-colored cottons, linens, and mixed loads	Colors
Sturdy towels and washcloths	Towels

How Do You Want to Wash Them?	"How to Wash" Cycle Selection:
Regular/Normal	Normal
With fewer wrinkles	Wrinkle Control
Intense Cleaning	Heavy Duty
Eliminate 99.9% of three common household bacteria	Sanitize* (with Oxi –on some models)
Gentle cleaning with cold water	Cold Wash
Fast	Quick

Settings and options shown in bold are default settings for that wash cycle. For best fabric care, choose the cycle, options, and settings that best fit the load being washed. Always read and follow fabric care labels and laundry product instructions. Avoid tightly packing the washer. The washer will not rinse well or spin correctly if tightly packed. If running Wash & Dry, loading the drum 1/4 full or less will improve drying performance and cycle time. Not all settings are available with each cycle, and some options cannot be used together. Not all options are available on all models.

What	How	Basic Settings			Additional Options				
		Temp	Spin	Soil	Steam Clean	Extra Rinse	PreSoak	Wash & Dry	Load & Go™
Regular	Normal	Hot Very Warm Warm Cool Cold	Fast Medium Fast Medium Off	Light Normal Heavy	X	X	X	X	X
	Wrinkle Control	Hot Very Warm Warm Cool Cold	Fast Medium Fast Medium Slow Off	Light Normal Heavy	X	X	X	X	X
	Heavy Duty	Hot Very Warm Warm Cool Cold	Fast Medium Fast Medium Off	Light Normal Heavy	X	X	X	X	X
	Sanitize* (with Oxi – on some models)	Hot	Fast Medium Fast Medium	Light Normal Heavy	X	X		X	X
	Cold Wash	Hot Very Warm Warm Cool Cold	Fast Medium Fast Medium Off	Light Normal Heavy		X	X	X	X
	Quick	Hot Very Warm Warm Cool Cold	Fast Medium Fast Medium Off	Light Normal Heavy	X	X	X	X	X



What	How	Basic Settings			Additional Options				
		Temp	Spin	Soil	Steam Clean	Extra Rinse	PreSoak	Wash & Dry	Load & Go™
Delicates	Normal	Hot Very Warm Warm Cool Cold	Fast Medium Fast Medium Slow Off	Light Normal Heavy	X	X	X	X	X
	Quick	Hot Very Warm Warm Cool Cold	Fast Medium Fast Medium Slow Off	Light Normal Heavy	X	X	X	X	X
	Wrinkle Control	Hot Very Warm Warm Cool Cold	Fast Medium Fast Medium Slow Off	Light Normal Heavy	X	X	X	X	X
	Heavy Duty	Hot Very Warm Warm Cool Cold	Fast Medium Fast Medium Slow Off	Light Normal Heavy	X	X	X	X	X
	Cold Wash	Hot Very Warm Warm Cool Cold	Fast Medium Fast Medium Slow Off	Light Normal Heavy		X	X	X	X
	Sanitize* (with Oxi – on some models)	Hot	Fast Medium Fast Medium Slow Off	Light Normal Heavy	X	X		X	X
Bulky Items	Normal	Hot Very Warm Warm Cool Cold	Fast Medium Fast Medium Slow Off	Light Normal Heavy	X	X	X	X	X
	Quick	Hot Very Warm Warm Cool Cold	Fast Medium Fast Medium Slow Off	Light Normal Heavy	X	X	X	X	X
	Wrinkle Control	Hot Very Warm Warm Cool Cold	Fast Medium Fast Medium Slow Off	Light Normal Heavy	X	X	X	X	X
	Heavy Duty	Hot Very Warm Warm Cool Cold	Fast Medium Fast Medium Slow Off	Light Normal Heavy	X	X	X	X	X
	Cold Wash	Hot Very Warm Warm Cool Cold	Fast Medium Fast Medium Slow Off	Light Normal Heavy		X	X	X	X



What	How	Basic Settings			Additional Options				
		Temp	Spin	Soil	Steam Clean	Extra Rinse	PreSoak	Wash & Dry	Load & Go™
Whites	Normal	Hot Very Warm Warm Cool Cold	Fast Medium Fast Medium Slow Off	Light Normal Heavy	X	X	X	X	X
	Quick	Hot Very Warm Warm Cool Cold	Fast Medium Fast Medium Slow Off	Light Normal Heavy	X	X	X	X	X
	Wrinkle Control	Hot Very Warm Warm Cool Cold	Fast Medium Fast Medium Slow Off	Light Normal Heavy	X	X	X	X	X
	Heavy Duty	Hot Very Warm Warm Cool Cold	Fast Medium Fast Medium Slow Off	Light Normal Heavy	X	X	X	X	X
	Cold Wash	Hot Very Warm Warm Cool Cold	Fast Medium Fast Medium Slow Off	Light Normal Heavy		X	X	X	X
	Sanitize* (with Oxi – on some models)	Hot	Fast Medium Fast Medium Slow Off	Light Normal Heavy	X	X		X	X
Colors	Normal	Hot Very Warm Warm Cool Cold	Fast Medium Fast Medium Slow Off	Light Normal Heavy	X	X	X	X	X
	Quick	Hot Very Warm Warm Cool Cold	Fast Medium Fast Medium Slow Off	Light Normal Heavy	X	X	X	X	X
	Wrinkle Control	Hot Very Warm Warm Cool Cold	Fast Medium Fast Medium Slow Off	Light Normal Heavy	X	X	X	X	X
	Heavy Duty	Hot Very Warm Warm Cool Cold	Fast Medium Fast Medium Slow Off	Light Normal Heavy	X	X	X	X	X
	Cold Wash	Hot Very Warm Warm Cool Cold	Fast Medium Fast Medium Slow Off	Light Normal Heavy		X	X	X	X
	Sanitize* (with Oxi – on some models)	Hot	Fast Medium Fast Medium Slow Off	Light Normal Heavy	X	X		X	X



What	How	Basic Settings			Additional Options				
		Temp	Spin	Soil	Steam Clean	Extra Rinse	PreSoak	Wash & Dry	Load & Go™
Towels	Normal	Hot Very Warm Warm Cool Cold	Fast Medium Fast Medium Slow Off	Light Normal Heavy	X	X	X	X	X
	Quick	Hot Very Warm Warm Cool Cold	Fast Medium Fast Medium Slow Off	Light Normal Heavy	X	X	X	X	X
	Wrinkle Control	Hot Very Warm Warm Cool Cold	Fast Medium Fast Medium Slow Off	Light Normal Heavy	X	X	X	X	X
	Heavy Duty	Hot Very Warm Warm Cool Cold	Fast Medium Fast Medium Slow Off	Light Normal Heavy	X	X	X	X	X
	Cold Wash	Hot Very Warm Warm Cool Cold	Fast Medium Fast Medium Slow Off	Light Normal Heavy		X	X	X	X
	Sanitize* (with Oxi – on some models)	Hot	Fast Medium Fast Medium Slow Off	Light Normal Heavy	X	X		X	X

Government energy certifications for models WFW8620H and WFW862CH were based on the REGULAR (WHAT TO WASH), NORMAL (HOW TO WASH), FASTEST SELECTABLE SPIN SPEED, HOLDING “DRAIN & SPIN” for 3 SECONDS TO ACTIVATE TIMED DRY (4 HOURS - 1 TIME ONLY), DRYING TEMPERATURE SETTING NON - SELECTABLE. The as-shipped defaults of REGULAR (WHAT TO WASH), NORMAL (HOW TO WASH), WARM TEMP, SPIN SPEED FAST were not used for energy testing.

CHOOSING THE RIGHT DETERGENT

Use only High Efficiency detergents. The package will be marked “HE” or “High Efficiency.” Low-water washing creates excessive sudsing with a non-HE detergent. Using non-HE detergent will likely result in longer cycle times and reduced rinsing performance. It may also result in component malfunction and, over time, buildup of mold or mildew. HE detergents should be low-sudsing and quick-dispersing to produce the right amount of suds for the best performance. They should hold soil in suspension so it is not redeposited onto clean clothes. Not all detergents labeled as High Efficiency are identical in formulation and their ability to reduce suds. For example, natural, organic, or homemade HE detergents may generate a high level of suds. If you use one of these and see a “SUD” error code appear in the display, consider using a different HE detergent. Always follow the detergent manufacturer’s instructions to determine the amount of detergent to use.



Use only High Efficiency (HE) detergent.

About Detergent Concentration

Today's liquid HE detergents are concentrated. Most brands of concentrated HE detergent will show the level of concentration on the bottle.

However, if the detergent bottle does not give the concentration, it can be easily calculated. Just divide the package size in fluid ounces by the number of loads. Then refer to the chart below to find the concentration.

If you do not get your desired cleaning results, try using a lower concentration number. If you have excess suds, try using a higher concentration number.

If detergent concentration is not 2x, change the detergent concentration setting by touching and holding TEMP and SOIL for 3 seconds.

Concentration	Number of ounces ÷ number of loads
2X	1.5–2.49 (44.4 mL–73.6 mL)
3X	0.9–1.49 (26.6 mL–44.1 mL)
4X	0.7–0.89 (20.7 mL–26.3 mL)
5X	0.5–0.69 (14.8 mL–20.4 mL)
6X	0.3–0.49 (8.9 mL–14.5 mL)

USING THE DISPENSERS (varies by model)

1. For automatic dispensing, open the bulk dispenser drawer using the handle at the base of the washer. For a single load, open the single load dispenser drawer at the top left corner of the washer and disable the Load & Go™ option.
2. Add laundry products as described below.
3. Slowly close the dispenser drawer. Make sure it is completely closed.

NOTES:

- A small amount of water may remain in the single load dispenser from the previous wash cycle. This is normal.
- See “About Detergent Concentration” for information on detergent concentration.
- On some models: When detergent in the bulk dispenser is running low, the display will show the detergent level (Low).
- Add single-dose and Oxi-type boosters to the drum before loading items. See the “Using Your Washer” section.



Adding HE detergent to dispenser

Load & Go™ bulk dispenser (on some models)

Use only High Efficiency (HE) liquid detergents. The bulk dispensers will hold about 67.6 oz (2 L) or 33.8 oz (1 L) of liquid HE detergent, depending on dispenser, or enough for many loads of laundry.



To Fill Bulk Dispensers:

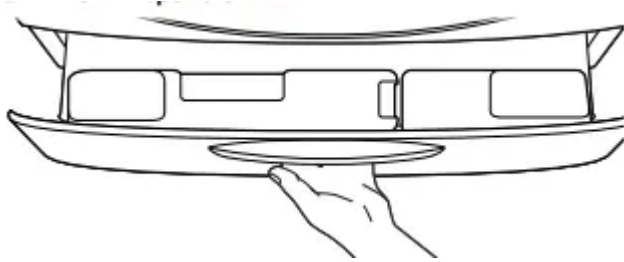

Open the dispenser drawer by pulling on the handle at the base of the washer. If desired, the drawer can be completely removed from the washer.

Locate the Load & Go™ bulk dispenser. Gently pull up on the tab located on the bulk dispenser lid to lift the fill door.

Fill to the "MAX" line (see illustrations at right) with HE liquid detergent. Close fill door.

It will click into place. Make sure the concentration is correct (see the "Choosing the Right Detergent" section).

The dispensers should be rinsed out when changing detergents or when the washer will not be used for extended periods. For instructions on cleaning the dispenser cartridge, see the "Washer Care" section.

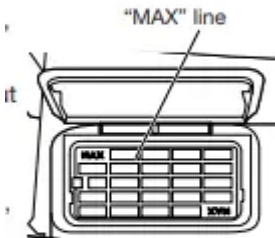
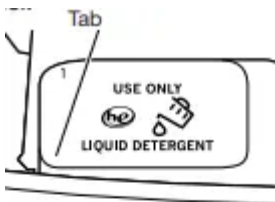

Adding detergent for a single load

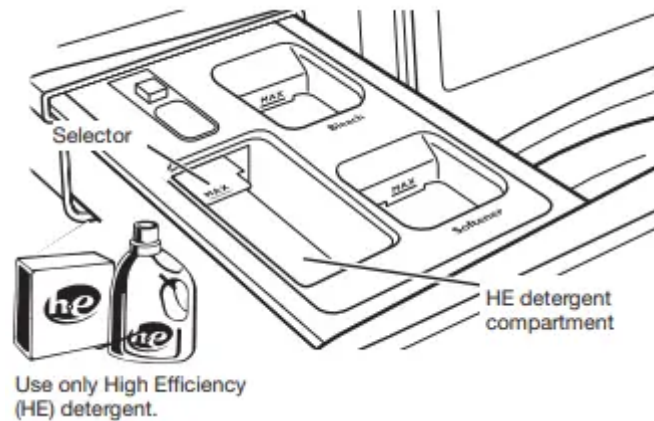

Pour a measured amount of HE detergent into detergent compartment. For powdered detergent, lift the selector to the high position. For liquid detergent, push down the selector to the low position.

Do not overfill; adding too much detergent may cause detergent to be dispensed into the washer too early.



Powdered detergent:
Lift the selector to the high position. Add directly to the compartment.

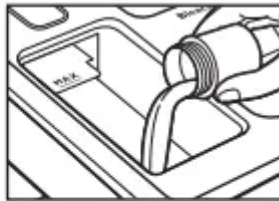

Liquid detergent:
Push down the selector to the low position. Add directly to the compartment.

IMPORTANT:

- Disable the Load & Go™ option before starting a single load.
- Do not add single-dose laundry packet to dispenser drawer.

USING YOUR WASHER

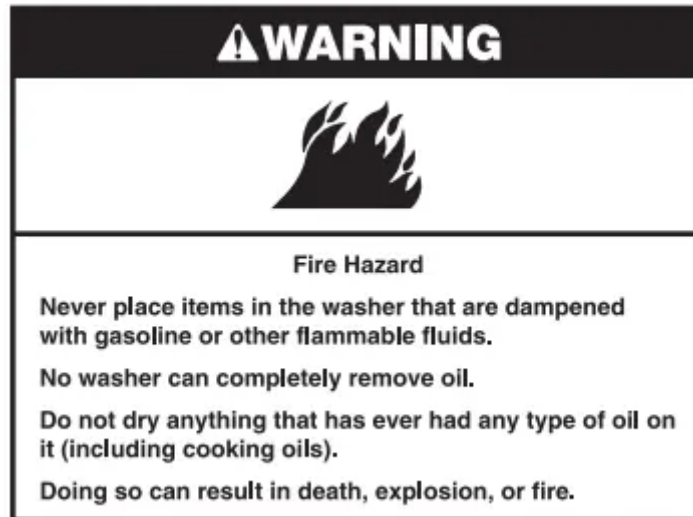

First wash cycle without laundry

Before washing clothes for the first time, set up the Load & Go™ bulk dispenser (on some models) or add detergent to the single-dose dispenser (see the “Using the Dispensers” section). Choose the Regular (what to wash) and Quick (how to wash) cycle and run it without clothes. Use only HE detergent. This initial cycle serves to ensure the interior is clean.

1 Sort and prepare your laundry



Sort items by recommended cycle, water temperature, and colorfastness. Separate heavily soiled items from lightly soiled. Separate delicate items from sturdy fabrics. Treat stains promptly and check for colorfastness by testing stain remover products on an inside seam.

IMPORTANT:

- Empty pockets. Loose change, buttons, or any small object can plug pumps and may require a service call.
- Close zippers, fasten hooks, tie strings and sashes, and remove non-washable trim and ornaments.

- Mend rips and tears to avoid further damage to items during washing.
- Turn knits inside out to prevent pilling. Separate lint-takers from lint-givers. Synthetics, knits, and corduroy fabrics will pick up lint from towels, rugs, and chenille fabrics.
- Do not dry garments if stains remain after washing because heat can set stains into fabric.
- Always read and follow fabric care labels and laundry product instructions. Improper usage may cause damage to your garments.

2 Add laundry products, if desired

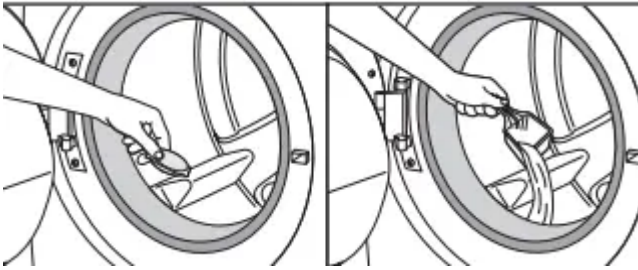

Single-dose laundry packets, Oxi-type boosters, color-safe bleach, or scented crystals can be added to the drum prior to adding laundry. When using single-dose laundry packets, make sure that the bulk dispenser is disabled (on some models) or off (see the “Control Panel and Features” section).

NOTE: Always follow manufacturer’s instructions.

3. Load laundry into washer

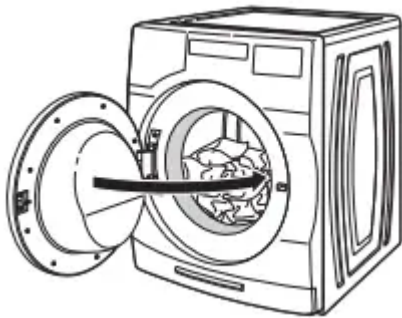

Place a load of sorted items loosely in the washer. Items need to move freely for best cleaning and to reduce wrinkling and tangling. If using the Wash & Dry option, loading the drum half full or less and not interrupting the drying cycle by opening the door will improve drying performance and cycle time. Close the washer door by pushing it firmly until the latch clicks.

- Push load fully into the washer. Make sure no items are resting on the rubber seal to avoid trapping them between the seal and the door window.
- Mix large and small items and avoid washing single items. Load evenly.
- Wash small items in mesh garment bags. For multiple items, use more than one bag and fill bags equally.

4 Add HE detergent

Load & Go™ Bulk Dispenser (on some models)

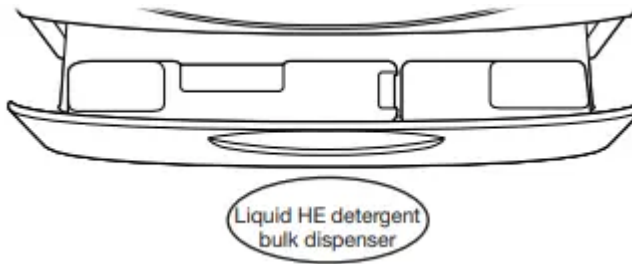

If the bulk dispenser already contains enough detergent to wash your load, simply choose the Load & Go™ option as described in Step 10. If you need to add detergent to the bulk dispenser, see “Using the Dispensers” section.

OR

Single Load Dispenser Drawer

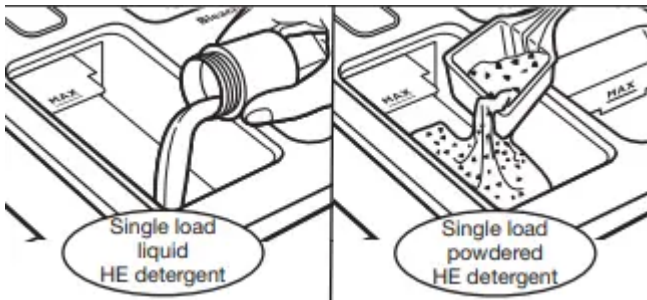

Adjust the selector, based on type of HE detergent used (either liquid or powdered). Add a measured amount of detergent directly into the detergent compartment. See the “Using the Dispensers” section. Disable the Load & Go™ option.

NOTE: Do not add single-dose laundry packets, Oxi-type boosters, color-safe bleach, or scented crystals to dispensers. They will not dispense correctly

5 Add liquid fabric softener to single load dispenser, if desired

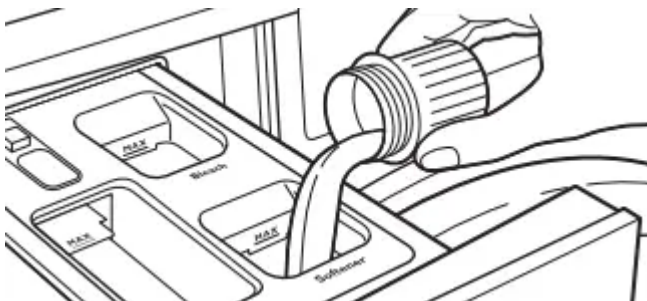

Pour a measured amount of liquid fabric softener into liquid fabric softener compartment. Always follow manufacturer’s directions for correct amount of fabric softener, based on your load size.

Fabric softener is always dispensed in the last rinse, even if Extra Rinse is selected.

IMPORTANT: Do not overfill, dilute, or use more than the manufacturer-recommended quantity of fabric softener. Do not fill past the “MAX” line. Overfilling dispenser will cause fabric softener to immediately dispense into washer.

- Do not spill or drip any fabric softener onto the clothes.
- Do not use liquid fabric softener dispenser balls in this washer. They will not dispense correctly.
- Do not use fabric softener sheets, as they can stain the load

6 Add liquid chlorine bleach to single load dispenser, if desired

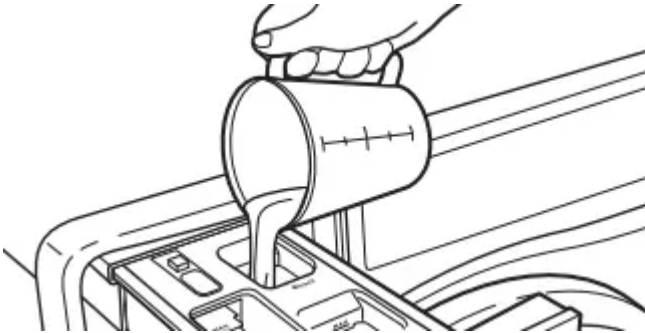

Add liquid chlorine bleach to the bleach compartment. Do not overfill, dilute, or use more than 2/3 cup (165 mL). Do not use color-safe bleach or Oxi in the same cycle with liquid chlorine bleach.

IMPORTANT:

- Always measure liquid chlorine bleach. Use a measuring cup with a pour spout; do not guess.
- Do not fill beyond the “MAX” line. Overfilling could cause garment damage.
- Do not use thickened, easy-pour, or no-splash bleach when running the Clean Washer with affresh® cycle, as excess suds may occur.
- On some models: Do not add liquid chlorine bleach to the bulk dispenser.
- Slowly close dispenser drawers. Make sure the drawers are closed completely.

7 Touch **POWER** to turn on washer

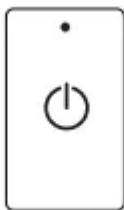

8 Select a wash program/cycle

REGULAR	DELICATES	BULKY ITEMS	WHITES	COLORS	TOWELS
NORMAL	WRINKLE CONTROL	HEAVY DUTY	SANITIZE with OXI	COLD WASH	QUICK

First, choose what you want to wash by touching a selection in the top row. Next, choose how you want to wash your load by touching a selection in the bottom row to choose the best cycle combination for your load. See “Cycle Guide” for details on cycles features.

9 Adjust cycle modifiers, if desired*

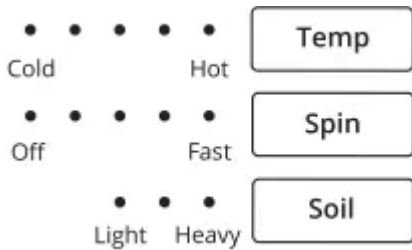

The led indicator lights will show the default settings for the selected cycle. To adjust a setting, touch its name – Temp, Spin, or Soil. Adjusting settings may change the Estimated Time Remaining. Tightly packing the load, unbalanced loads, or excessive suds may also cause the washer to increase the cycle time.

10 Select any additional options*

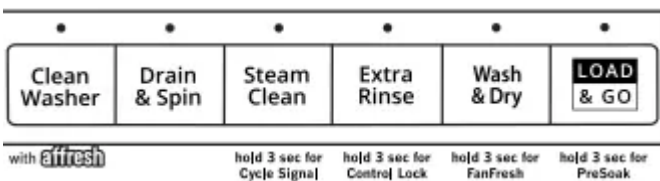

To add an option to the cycle, touch its name – Steam Clean, Extra Rinse, or Wash & Dry. If you wish to use the bulk dispenser (on some models), select Load & Go™. For other options, touch and hold the buttons indicated for 3 seconds. To remove an option from the selected cycle, touch that button again.

11 Touch and hold START/PAUSE to begin wash cycle



Touch and hold START/PAUSE for 3 seconds to start the wash cycle. To pause a cycle in progress, touch START/PAUSE once; then touch and hold again to continue the cycle. To cancel a cycle, touch and hold POWER and run Drain & Spin to remove any excess water.

Once you touch and hold START/PAUSE, you will hear the door lock. The washer door will remain locked during the wash cycle.

Unlocking the door to add garments:



If you need to open the door to add one or two missed garments, you may do so while the “Add Garment” light is lit. The time allowed to add a garment will vary based on cycle selection and load size.

Touch START/PAUSE once; the door will unlock once the washer movement has stopped. This may take several minutes. Then close door and touch and hold START/PAUSE again to restart the cycle.



Adding items after “Add Garment” light is off:

Cancel current cycle. Water will drain and you will need to reselect cycle and restart.

For best wash performance and optimal energy savings, add garments only when the “Add Garment” light is on.

12 Remove garments promptly after cycle is finished

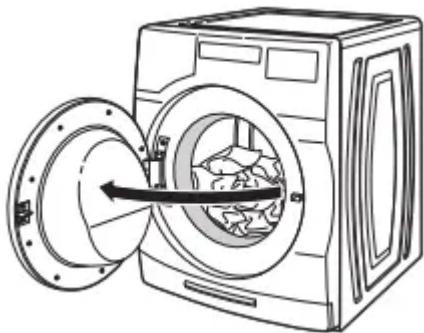

Promptly remove garments after cycle has completed to avoid odor and rusting of metal objects on garments. When unloading garments, pull back the door seal and check for small items between the tub and the washer drum.



If you will be unable to remove the load promptly, use the FanFresh® option if it is available on your model. If the FanFresh® option is selected, the washer will automatically activate the fan once the cycle ends and tumble the load periodically for up to 12 hours. After a Wash & Dry cycle, promptly remove garments after cycle has completed to reduce wrinkling.

NOTES:

- To cancel the FanFresh® option, touch POWER or START/PAUSE.
- This washer has a tight seal to avoid water leaks. To avoid odors, leave the door open to allow the washer to dry between uses.
- If a dry cycle is interrupted and the load removed before the cool-down period at the end of the cycle, the load will be very hot.

WASHER MAINTENANCE

WATER INLET HOSES

Replace inlet hoses after five years of use to reduce the risk of hose failure. Periodically inspect and replace inlet hoses if bulges, kinks, cuts, wear, or leaks are found.

When replacing your inlet hoses:

Mark the date of replacement on the label with a permanent marker.

Check that the old washers are not stuck on the washer inlet valves.

Use new washers in the new inlet hoses to ensure a proper seal.

WASHER CARE

Recommendations to Help Keep Your Washer Clean and Performing at Its Best

1. Always use High Efficiency (HE) detergents and follow the HE detergent manufacturer's instructions regarding the amount of HE detergent to use. Never use more than the recommended amount because that may increase the rate at which detergent and soil residue accumulate inside your washer which, in turn, may result in undesirable odor.
2. Use warm or hot water washes sometimes (not exclusively cold water washes) because they do a better job of controlling the rate at which soils and detergent accumulate.
3. Always leave the washer door slightly ajar between uses to help dry out the washer and avoid the buildup of odor-causing residue.
4. Periodically clean residue from all interior surfaces of the window. For better care, wipe the entire inside of the door with a damp cloth.

Cleaning Your Front Loading Washer

Read these instructions completely before beginning the routine cleaning processes recommended below. This washer maintenance procedure should be performed, at a minimum, once per month or every 30 wash cycles, whichever occurs sooner, to control the rate at which soils and detergent may otherwise accumulate in your washer.

Cleaning the Door Seal

1. Open the washer door and remove any clothing or items from the washer.

2. Inspect the gray-colored seal between the door opening and the drum for stained areas, soil buildup, or lint. Pull back the seal to inspect all areas under the seal and to check for foreign objects or lint.
3. If stained areas, soil buildup, or lint are found, wipe down these areas of the seal using either of the following two procedures:

a. affresh® Machine Cleaning Wipes Procedure:

- i. When the cycle is complete, gently pull back the rubber door seal and clean the entire surface with the textured side of an affresh® Machine Cleaning Wipe.

b. Dilute Liquid Chlorine Bleach Procedure:

- i. Mix a dilute bleach solution, using 3/4 cup (177 mL) of liquid chlorine bleach and 1 gallon (3.8 L) of warm tap water.
- ii. Wipe the seal area with the dilute solution, using a damp cloth.
- iii. Let stand 5 minutes.
- iv. Wipe down area thoroughly with a dry cloth and let washer interior air dry with door open.

IMPORTANT:

- Wear rubber gloves when cleaning with bleach.
- Refer to the bleach manufacturer's instructions for proper use.

Cleaning the Inside of the Washer

This washer has a special cycle that uses higher water volumes in combination with affresh® Washer Cleaner or regular liquid chlorine bleach to thoroughly clean the inside of the washer. Steam washer models also utilize steam to enhance cleaning in this special cycle.

IMPORTANT: Do not use thickened, easy-pour, or no-splash bleach when running the Clean Washer with affresh® cycle as excess suds may occur.

NOTE: Read these instructions completely before beginning the cleaning process.

Begin procedure

1. Clean Washer with affresh® Cycle Procedure (Recommended for best performance):

- a. Open the washer door and remove any clothing or items.
- b. Use an affresh® Machine Cleaning Wipe or a soft, damp cloth or sponge to clean the inside door window.
- c. Add an affresh® Washer Cleaner tablet to the washer drum.
- d. Do not add the affresh® Washer Cleaner tablet to the dispenser drawer.
- e. Do not add any detergent or other chemical to the washer when following this procedure.
- f. Close the washer door.

g. Select the Clean Washer with affresh® cycle.

h. On some models: Select the FanFresh® option to help dry the washer interior after the cycle is complete.

NOTE: The washer remembers your last option selection and will use it for future wash cycles until you deselect that option.

i. Touch and hold START/PAUSE to begin the cycle. The Clean Washer with affresh® cycle operation is described below.

2. Chlorine Bleach Procedure:

a. Open the washer door and remove any clothing or items.

b. Open the single load dispenser drawer and add regular liquid chlorine bleach to the “MAX” line in both the bleach compartment and the fabric softener compartment. Either traditional or HE chlorine bleach can be used.

IMPORTANT: Do not use thickened, easy-pour, or no-splash bleach as excess suds may occur.

NOTE: Use of more liquid chlorine bleach than is recommended above could cause washer damage over time.

c. Close the washer door and the dispenser drawer.

d. Do not add any detergent or other chemicals to the washer when following this procedure.

e. Select the Clean Washer with affresh® cycle.

f. On some models: Select the FanFresh® option to help dry the washer interior after the cycle is complete.

NOTE: The washer remembers your last option selection and will use it for future wash cycles until you deselect that option.

g. Touch and hold START/PAUSE to begin the cycle. The Clean Washer with affresh® cycle operation is described below.

NOTE: For best results, do not interrupt cycle.

Description of Clean Washer with affresh® Cycle Operation:

1. The Clean Washer with affresh® cycle will determine whether clothing or other items are in the washer.

2. If no items are detected in the washer, it will proceed with the cycle.

a. If any items are detected in the washer, “rL” (remove load) will be displayed. The door will unlock. Open washer and remove any garments from the washer drum.

b. Touch POWER to clear the “rL” code.

c. Touch and hold START/PAUSE to restart the cycle.

3. Steam models only: During the first 20 minutes of the cycle, it will activate the steamer but the drum will not spin or fill with water. You may see condensation on the door window during this initial phase. If you are using an affresh® Washer Cleaner tablet, it will not dissolve completely during the steam phase. This is normal.

After the cycle is complete, leave the door open slightly to allow for better ventilation and drying of the washer interior.

Cleaning the Dispensers

After using the Clean Washer with affresh® cycle, you may find some residue buildup in the washer's dispensers.

To remove residue from the single load dispenser, remove the drawer and wipe the surfaces with an affresh® Machine

Cleaning Wipe or a damp cloth and towel dry either before or after you run the Clean Washer with affresh® cycle. Use an all-purpose surface cleaner, if needed.

On some models: To remove residue from the Load & Go™ bulk dispenser, lift the handle on the dispenser housing and pull to remove it from the washer cabinet; then rinse the dispenser thoroughly with running water. Wipe the outside dispenser surface with an affresh® Machine Cleaning Wipe or a damp cloth, and towel dry. Use an all-purpose surface cleaner, if needed.

Replace the dispenser in the washer cabinet and make sure that it is correctly seated.

IMPORTANT: Dispensers are not dishwasher-safe.

Cleaning the Outside of the Washer

Use an affresh® Machine Cleaning Wipe or a soft, damp cloth or sponge to wipe up any spills. Occasionally wipe the outside of your washer to help keep it looking new. Use an affresh® Machine Cleaning Wipe or mild soap and water.

IMPORTANT: To avoid damaging the washer's finish, do not use abrasive products.

REMOVING THE DISPENSER

Single Load Dispenser Drawer

Removing the Dispenser

To remove:

1. Pull dispenser drawer out until it stops.

2. Press down on the release tab and pull straight out to remove the dispenser.

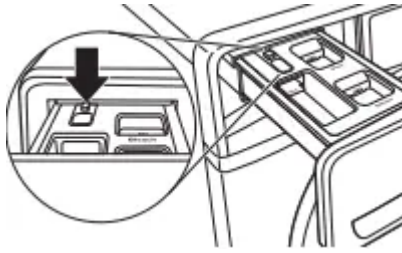

- 3.

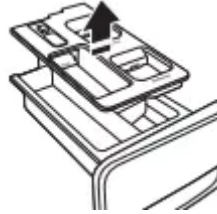

Lift off cover panel by pulling straight up.

To replace:

1. Position cover panel back onto posts on dispenser. Apply slight pressure on cover panel to seat it.
2. Align edges of dispenser with guides in washer; then slide dispenser back into slot.

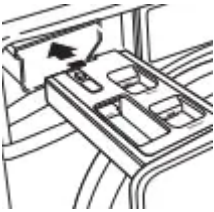

CLEANING LOAD & GO™ CONTAINERS(on some models)

It is recommended that you rinse out the Load & Go™ containers when refilling, when changing detergent types or concentrations, or when the washer will not be used for an extended period.

1. Pull the dispenser drawer out until it stops.
2. Lift out the Load & Go™ containers.
3. Lift the fill lid and flush interior thoroughly with warm water.
4. Allow to air dry.

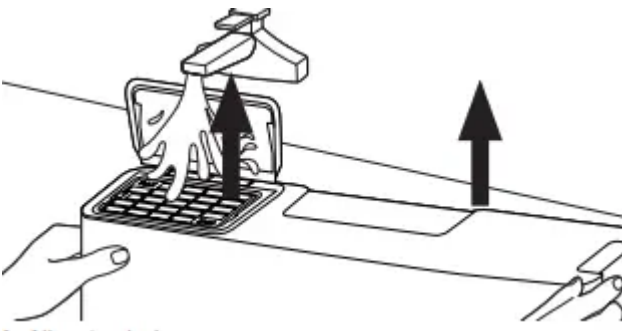

IMPORTANT: Containers are not dishwasher-safe.

CLEANING THE DRAIN PUMP FILTER/DRAINING RESIDUAL WATER (on some models)

1. Open the dispenser drawer by pulling on the handle at the base of the washer/dryer. This will reveal the drain pump filter. Remove the drawer by releasing the tab on each side.

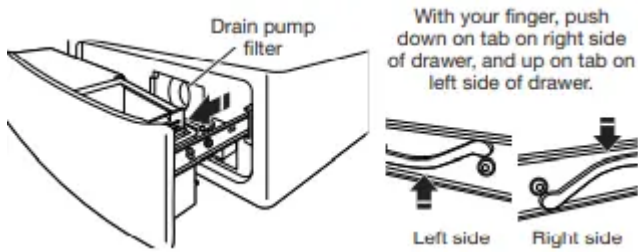

2. Place a broad, flat container beneath the drain pump filter to collect the drain water. Release the black hose from the hose clip, remove the plug, and drain the hose into the container. Empty the container. Repeat this procedure if necessary until all the water has drained. Make sure that the black hose is completely dry, replace the plug, and secure the hose in the clip.

NOTE: If water does not drain well, push in hose slightly to remove any possible kinks.

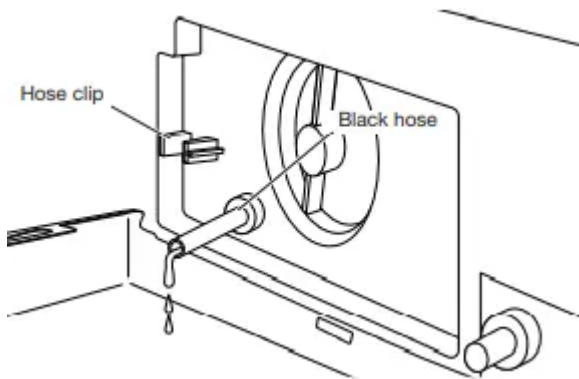

3. Lay a cotton cloth beneath the drain pump filter to absorb any water still in it. Then remove the drain pump filter by turning it counterclockwise.

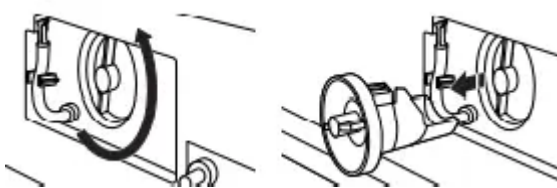

4. Remove large clumps of lint by hand from the filter and place lint in a suitable waste container. Remove remaining residue from the filter by rinsing with water.

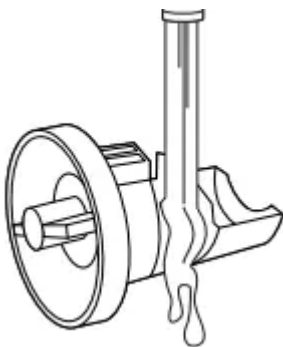

5. Reinsert the drain pump filter by turning it clockwise. Make sure to turn it in as far as it will go, with the filter handle remaining as close as possible to the vertical position.

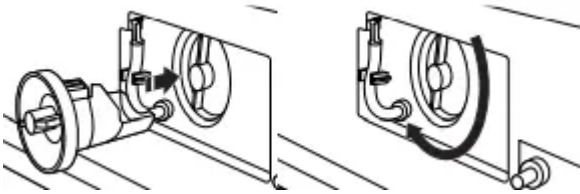

6. Replace and close the dispenser drawer. Make sure to insert both rails simultaneously when replacing the drawer. You will hear a clicking sound that indicates the rails have engaged. To ensure proper placement of the drawer, pull out fully. The drawer should be fully engaged and the rails locked in place. Make sure the drain hose is secured in the hose clip and tucked underneath the cutout.

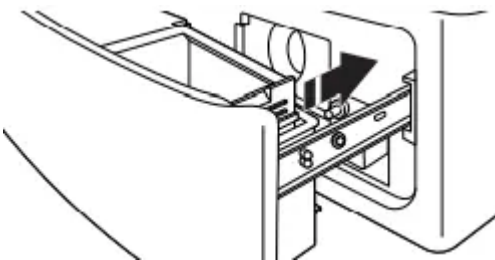

ADDITIONAL CLEANING

Gently pull back the rubber door seal and clean any stained areas, soil buildup, or lint with the textured side of an affresh® Machine Cleaning Wipe.



TROUBLESHOOTING

Error Code Appears in Display (for 2- and 3-digit displays)

Once any possible issues are corrected, touch POWER once to clear the code. Reselect and restart the cycle.

Sd” or “SUD”(excess suds) appears in display

- Excessive suds in washer. Washer is running a suds reduction routine.
 - Allow the washer to continue. Use only HE detergent. Always follow the detergent manufacturer’s instructions to determine the amount of detergent to use, and base detergent quantity on load size. Not all detergents labeled as

High Efficiency are identical in formulation and their ability to reduce suds. For example, natural, organic, or homemade HE detergents may generate a high level of suds. If you use one of these and see a "SUD" error code appear in the display, consider using a different HE detergent.

"Lo" followed by "FL" or "F8" followed by "E1" or "Lo" followed by "FL" or "F08" followed by "E01" (water supply error) appears in display

- Check for proper water supply.
 - Unit will drain for 8 minutes while door remains locked. The drain cycle must be allowed to complete, or the error code cannot reset. When complete, touch POWER once to clear the code. Then touch POWER again to restart washer. If code appears again, call for service.
 - Both hoses must be attached and have water flowing to the inlet valve.
 - Both hot and cold water faucets must be on.
 - Inlet valve screens on washer may be clogged.
 - Remove any kinks in the inlet hose.
 - If used, auto shut-off connectors and hoses must be properly installed and in working order.
- Check for proper inlet hoses.
 - Use only manufacturer's recommended inlet hoses.

F9" followed by "E1" or "F09" followed by "E01"(drain pump system error) appears in display

- Check plumbing for correct drain hose installation. Drain hose extends into standpipe farther than 41/2" (114 mm).
 - Check drain hose for proper installation.
 - Make sure the drain hose is not kinked, pinched, or blocked.
 - Remove any clogs from drain hose.
 - Use drain hose form and securely attach to drainpipe or tub.
 - Lower drain hose if the end is higher than 96" (2.4 m) above the floor.
- Not using HE detergent or using too much HE detergent.
 - Use only HE detergent. Always measure detergent and follow manufacturer's directions based on load size and soil level.

F5” followed by “E2” or “F05” followed by “E02” (door will not lock) appears in display

- Washer door not locking.
 - Touch POWER to cancel the cycle. Check that the door is closed completely and latching. Check for items in the washer drum that may be keeping the door from closing completely

rL” (remove load) appears in display

- Load detected in drum during Clean Washer with affresh® cycle.
 - Remove items from washer drum and restart Clean Washer with affresh® cycle.

F# E# or F## E## code other than as described above appears in display

- System error code.
 - Touch POWER once to clear the code. Then touch POWER again to restart washer. If code appears again, call for service. Unplug washer for 30 seconds; then plug back in.

Washer making error beeps

- Door has not been opened and closed for at least three cycles.
 - This code may occur when the washer is first turned on. Open and close the door to clear the display.

Washer beeps when Start/ Pause is touched

- Door not closed.
 - Close the door completely.

Clean Washer LED flashing at end of wash cycle(on some models)

- The washer has run 30 wash cycles and is indicating a reminder to run the Clean Washer with affresh® cycle.
 - Run the Clean Washer with affresh® cycle. If the Clean Washer with affresh® cycle is not turned on, the LED will stop flashing at the end of a wash cycle after running three more regular wash cycles. After 30 more wash cycles are completed, the Clean Washer with affresh® LED will again flash at the end of a wash cycle as a reminder.

Vibration or Off-Balance

Vibration, rocking, or “walking”

- Feet may not be in contact with the floor and locked.
 - Front and rear feet must be in firm contact with floor, and washer must be level to operate properly. Jam nuts must be tight against the bottom of the cabinet.
- Washer may not be level.
 - Check floor for flexing or sagging. If flooring is uneven, a 3/4" (19 mm) piece of plywood under your washer will reduce sound. Do not install washer on a raised wooden platform.
 - See “Level the Washer” in Installation Instructions.
- Load could be unbalanced or too large.
 - Avoid tightly packing the load. Avoid washing single items. Balance a single item such as a rug or jeans jacket with a few extra items.
 - Item or load not suitable for selected cycle. See “Cycle Guide” and “Using Your Washer.”
- The shipping bolts are still in the back of the washer.
 - See “Remove transport bolts from washer” in the Installation Instructions.

Noises

Clicking or metallic noises

- Door locking or unlocking.
 - After starting a cycle the drum will make a partial turn and the door will lock. The door will remain locked until the end of cycle. This is normal.
- Objects caught in washer drain system.
 - Empty pockets before washing. Loose items such as coins could fall between washer drum and tub or may block pump. It may be necessary to call for service to remove items.
 - It is normal to hear metal items on clothing such as metal snaps, buckles, or zippers touch against the stainless steel drum.

Gurgling or humming

- Washer may be draining water.
 - The pump may make a humming sound with periodic gurgling or surging as final amounts of water are removed during the spin/drain cycles. This is normal at certain stages of the cycle.

Rolling or sloshing and occasional clicking (on slow-speed spin)

- Steel balls in the balancing system are balancing the load.
 - This is normal at certain stages of the cycle.

Water Leaks

Check the following for proper installation

- Fill hoses not attached tightly.
 - Tighten fill-hose connection.
- Fill hose washers.
 - Properly seat all four fill-hose flat washers.
- Drain hose connection.
 - Check that the drain hose is properly secured to drainpipe or laundry tub.
- One some models: Drain pump filter is not properly seated.
 - One some models: Make sure filter is correctly placed in the housing. See “Cleaning the Drain Pump Filter/Draining Residual Water.”
- Check household plumbing for leaks or clogged sink or drain.
 - Water can back up out of a clogged sink or drainpipe. Check all household plumbing for leaks (laundry tubs, drain pipe, water pipes, and faucets.)
- Strainer (or nylon stocking) on end of drain hose is clogged.
 - Remove strainer/stocking from drain hose.

Water or suds leaking from door or rear of cabinet

- Not using HE detergent or using too much HE detergent.
 - Only use HE detergent. Suds from regular detergents can cause leaking from the door or rear of cabinet. Always measure detergent and follow manufacturer’s directions based on your load requirements.
- Using thickened, easy-pour, or no-splash bleach when running the Clean Washer with affresh® cycle.
 - Use affresh® tablet or regular, non-thickened chlorine bleach when running the Clean Washer with affresh® cycle.
- Residue on door window.
 - Periodically clean the underside of the window to avoid potential leaks.

- Door opened during “Add Garment.”
 - Water can drip off the inside of the door when the door is opened after the start of a cycle.

Leaking around door

- Hair, lint, or other debris on inner door window preventing proper seal with rubber door seal.
 - Clean inner door window and seal. See “Cleaning the Door Seal” in the “Washer Maintenance” section.

Washer Not Performing As Expected

Load not completely covered in water

- Water level not visible on door or does not cover clothes.
 - This is normal for an HE front-load washer. The washer senses load sizes and adds the correct amount of water for optimal cleaning.

Washer won’t run or fill; washer stops working

- Check for proper water supply.
 - Both hoses must be attached and have water flowing to the inlet valve.
 - Both hot and cold water faucets must be turned on.
 - Check that inlet valve screens have not become clogged.
 - Check for any kinks in inlet hoses, which can restrict water flow.
- Check proper electrical supply.
 - Plug power cord into a grounded 3 prong outlet.
 - Do not use an extension cord.
 - Ensure there is power to outlet.
 - Do not plug into a GFCI (Ground Fault Circuit Interrupter).
 - Check electrical source or call an electrician to check if voltage is low.
 - Reset a tripped circuit breaker. Replace any blown fuses.

NOTE: If problems continue, contact an electrician.

- The load size is being sensed.
 - After the load size is sensed, the estimated time based on load size will be displayed and water will be added.
- Normal washer operation.
 - Door must be completely closed and latched for washer to run.

- The washer pauses for about 2 minutes during certain cycles. Allow the cycle to continue. Some cycles feature periods of tumbling and soak.
- Washer may be stopped to reduce suds. Use only a proper amount of HE detergent.
- Cold Wash uses less water in the beginning of the cycle to provide a high concentration of detergent for optimal cleaning action. Following this concentrated tumbling, more water is used to complete the wash.
- During the first 20 minutes of the Clean Washer with affresh® cycle, it will activate the steamer but the drum will not spin or fill with water. You may see condensation on the door window during this initial phase. If you are using an affresh® Washer Cleaner tablet, it will not dissolve completely during the steam phase. This is normal.
- The washer door is not firmly shut.
 - The door must be closed during operation.
- On some models: The Load & Go™ bulk dispenser is not fully seated in the washer.
 - Make sure that the Load & Go™ bulk dispenser is fully seated in the washer, and that the lid on the bulk dispenser is firmly closed.
- Washer not loaded as recommended.
 - Remove several items and rearrange load evenly in washer drum. Close door; then touch and hold START/PAUSE.
 - Do not add more than one or two additional items after cycle has started to avoid tightly packing or unbalancing.
 - Do not add more water to the washer.
- Not using HE detergent or using too much HE detergent.
 - Only use HE detergent. Suds from regular detergents can slow or stop the washer. Always measure detergent, following manufacturer's directions based on your load requirements.
 - To remove suds, cancel cycle. Select DRAIN & SPIN with EXTRA RINSE. Touch START/PAUSE. Do not add more detergent.
 - Make sure the Load & Go™ bulk dispenser is disabled if you are using a single dose of detergent.
- Door not opened between cycles.
 - After any wash cycle is completed, the door must be opened and then closed before a new cycle can begin.

Washer not draining/ spinning; loads are still wet

- Drain hose extends into standpipe farther than 4.5" (114 mm).
 - Check drain hose for proper installation. Use drain hose form and securely attach to drainpipe or tub. Do not tape over drain opening.
- The drain hose is clogged, or the end of the drain hose more than 96" (2.4 m) above the floor.
 - Lower drain hose if the end is higher than 96" (2.4 m) above the floor. Remove any clogs from drain hose. See "Installation Requirements" in Installation Instructions.
- Strainer/stocking on end of drain hose.
 - Remove strainer/stocking from drain hose.
- The drain hose fits too tightly in the standpipe, or it is taped to the standpipe.
 - The drain hose should be loose yet fit securely. Do not seal the drain hose with tape. The hose needs an air gap. See "Secure the Drain Hose" in Installation Instructions.
- Using cycles with a slower spin speed.
 - Cycles with slower spin speeds remove less water than cycles with fast spin speeds. Use the recommended cycle/ speed spin for your garment.
- Washer not loaded as recommended.
 - A tightly packed or unbalanced load may not allow the washer to spin correctly, leaving the load wetter than normal. See the Cycle Guide for load size recommendation for each cycle.
- The load may be out of balance.
 - Avoid washing single items. Balance a single item, such as a rug or jeans jacket with a few extra items.
- Not using HE detergent or using too much HE detergent.
 - Use only HE detergent. Suds from regular detergent or using too much detergent can slow or stop draining or spinning. Always measure and follow manufacturer's directions for your load. To remove extra suds, select DRAIN & SPIN with EXTRA RINSE. Do not add detergent.
- Small items may have been caught in the pump or stuck between the washer drum and the outer tub.
 - Check the drum for any items sticking through the drum holes. Empty pockets and use garment bags when washing small items.

- There are too many clothes in the Wash & Dry cycle.
 - Only use the Wash & Dry cycle for two to four lightly soiled synthetic garments, athletic uniforms, or workout wear.
- One some models: Drain pump filter is dirty.
 - One some models: Clean drain pump filter. See “Cleaning the Drain Pump Filter/Draining Residual Water.”
- Wash cycle has been canceled and door opened before water has drained.
 - Run Drain & Spin to remove any excess water.

Washer is spinning clothes without water

- The washer is measuring the mass of the dry load.
 - This measurement is normal and ensures the best cycle time for your load.

Door locked at end of wash cycle

- Water remaining in washer after cycle.
 - Select DRAIN & SPIN to remove any water remaining in the washer. The washer door will unlock at the end of the drain.

Door will not unlock

- Door locks when cycle has started.
 - If the “Add Garment” light is lit, touch START/PAUSE once. The door will unlock.

Incorrect or wrong wash or rinse temperatures

- Check for proper water supply.
 - Make sure hot and cold inlet hoses are not reversed.
 - Both hoses must be attached to both washer and faucet, and have both hot and cold water flowing to inlet valve.
 - Check that inlet valve screens are not clogged.
 - Remove any kinks in hoses.
- Washing many loads.
 - Your hot water tank may not have enough hot water to keep up with the number of hot or warm washes. This is normal.



Desired setting or option does not light

- For best performance, not all settings are available with each cycle, and some options cannot be used together.
 - See “Cycle Guide” for the available settings and options for each cycle.

Load not rinsed

- Check for proper water supply.
 - Make sure hot and cold inlet hoses are not reversed.
 - Both hoses must be attached and have water flowing to the inlet valves.
 - Both hot and cold water faucets must be on.
 - Inlet valve screens on washer may be clogged.
 - Remove any kinks in the inlet hoses.
- Not using HE detergent or using too much HE detergent.
 - The suds from non-HE detergent can cause the washer to operate incorrectly.
 - Use only HE detergent. Always measure detergent and follow manufacturer’s directions based on load size and soil level.
- Washer not loaded as recommended.
 - Avoid tightly packing the washer. The washer will not rinse well if tightly packed. Load with dry items only. See “Cycle Guide” for load size recommendations for each cycle.
 - Use cycle designed for the fabrics being washed.
 - Add only one or two garments after washer has started.
- The load may be out of balance.
 - When load imbalance occurs, a washing process will start to redistribute the load. This may lengthen the cycle time. Avoid washing single items. Balance a single item, such as a rug or jeans jacket, with a few extra items.

Load is wrinkled, twisted, or tangled

- Washer not loaded as recommended.
 - Add load loosely. Items need to move freely to reduce wrinkling and tangling. See “Cycle Guide” for load size recommendations for each cycle.
 - Reduce tangling by mixing types of load items. Use the recommended cycle for the type of garments being washed.

- Wash action too long for load.
 - Select a lower soil level. Note that items will not be cleaned as deeply as when using a higher soil level.
- Spin speed too fast for load.
 - Select a slower spin speed. Note that items will be wetter than when using a faster spin speed.
- The washer is not unloaded promptly.
 - Unload the washer as soon as it stops or use FanFresh® option if you will not be able to unload the washer at the end of the cycle.
- Not choosing the right cycle for the load being washed.
 - Use the Delicates cycle or another cycle with a slow spin speed to reduce wrinkling.
- The wash water was not warm enough to relax wrinkles.
 - If safe for load, use warm or hot wash water.

Not cleaning or removing stains

- Washer not loaded as recommended.
 - Add load loosely. Items need to move freely for best cleaning. See “Cycle Guide” for load size recommendations for each cycle.
 - Add only one or two garments after washer has started.
- Not using HE detergent or using too much HE detergent.
 - Use only HE detergent. Always measure detergent and follow manufacturer’s directions based on load size and soil level.
- Hard water or high level of iron (rust) in water.
 - You may need to install a water softener and/or iron filter.
- Fabric softener dispensing ball used.
 - Dispensing balls will not operate correctly with this washer. Add liquid fabric softener to the fabric softener compartment.
- Powdered detergent used for slow-speed cycle.
 - Consider using liquid detergent.
- Not using correct cycle for fabric type.
 - Use a higher soil level setting and warmer wash temperature to improve cleaning.
 - If using Quick Wash cycle, wash only a few items.

- Use Whites and Heavy Duty cycles for tough cleaning.
- Add an extra rinse for heavily soiled loads.
- Not using dispensers.
 - Use dispensers to avoid chlorine bleach and fabric softener staining.
 - Load dispensers before starting a cycle.
 - On some models: Make sure that the Load & Go™ bulk dispenser liquid detergent dispenser is not empty.
 - Avoid overfilling.
 - Do not add products other than those specified directly to load.
- Dispense cartridge is empty.
 - Fill dispense cartridge to the “MAX” line with HE liquid detergent.
- Detergent dispenser is not securely in place.
 - Pull out the dispenser, fill with detergent, and slide it back in place.
- Not washing like colors together.
 - Wash like colors together and remove promptly after the cycle is complete to avoid dye transfer.
- Not enough detergent used, or hard water.
 - Use more detergent for washing heavy soils in cold or hard water.

Odors

- Monthly maintenance not done as recommended.
 - Run the Clean Washer with affresh® cycle monthly or every 30 wash cycles. See “Washer Care” in the “Washer Maintenance” section.
 - Unload washer as soon as cycle is complete. Use the FanFresh® option if load cannot be removed immediately after the wash is complete.
- Not using HE detergent or using too much HE detergent.
 - Use only HE detergent. Be sure to measure correctly. Always follow the manufacturer’s directions.
 - See the “Washer Care” section.
- Door not left open after use.
 - This washer has a tight seal to avoid water leaks. To avoid odors, leave the door open to allow the washer to dry between uses.

Fabric damage

- Sharp items were in pockets during wash cycle.
 - Empty pockets, zip zippers, and snap or hook fasteners before washing to avoid snags and tears.
- Strings and straps could have tangled.
 - Tie all strings and straps before starting wash load.
- Items may have been damaged before washing.
 - Mend rips and broken threads in seams before washing.
- Fabric damage can occur if washer is tightly packed.
 - Avoid tightly packing the washer. Load with dry items only.
 - Use cycle designed for the fabrics being washed.
 - Add only one or two garments after washer has started.
- Fabric damage can occur if washer door is closed on an item, trapping it between the door window and the rubber seal.
 - Do not overfill the washer.
 - Push wash load fully into the washer.
- Liquid chlorine bleach may have been added incorrectly.
 - Do not pour liquid chlorine bleach directly onto load. Wipe up bleach spills.
 - Undiluted bleach will damage fabrics. Do not use more than recommended by manufacturer.

Gray whites, dingy colors

- Load not sorted properly.
 - The transfer of dye can occur when mixing whites and colors in a load. Sort dark clothes from whites and lights.
- Wash temperatures too low.
 - Use hot or warm temperatures if safe for the load. Make sure your hot water system is adequate to provide a hot water wash.
- Not enough detergent used, or hard water.
 - Use more detergent for washing heavy soils in cold or hard water.

Incorrect dispenser operation

- Clogged dispensers or laundry products dispensing too soon.
 - Do not overfill dispenser. Overfilling causes immediate dispensing.

- Load dispensers before starting a cycle.
- Homes with low water pressure may result in residual powder in the dispenser. To avoid, select a warmer wash temperature if possible, depending on your load.
- Liquid chlorine bleach not used in bleach compartment.
 - Use only liquid chlorine bleach in the bleach compartment.
- Water in dispenser after cycle has finished.
 - It is normal for small amounts of water to remain in dispenser at the end of the cycle.

Single-dose laundry packet not dissolving

- Adding laundry packet incorrectly.
 - Be sure laundry packet is added to washer drum before adding clothes. Do not add packet to dispenser. Follow the manufacturer's instructions to avoid damage to your garments.

Cycle time changes or cycle time too long

- Normal washer operation.
 - The cycle times vary automatically based on your water pressure, water temperature, detergent, and clothes load. The options you select will also affect the cycle times.
- Excessive suds in washer.
 - When excessive suds are detected, a special suds routine automatically starts to remove extra suds and ensure proper rinsing of your garments. This routine will add time to the original cycle.
- Load may be out of balance.
 - When load unbalance occurs, a washing process will start to redistribute the load. This extends the cycle time. Avoid washing single items. Balance a single item such as a rug or jeans jacket with a few extra items.
- Not using correct cycle for load type.
 - The Quick Wash cycle is designed for smaller load sizes (2–4 items) of lightly soiled garments. If larger loads are washed in this cycle, cycle time will be increased.
 - When using the Quick Wash or Delicates cycle, you should wash small loads. This ensures a gentle wash for your garments without increasing cycle time.

The controls are not responding

- Control Lock is On.
 - Touch and hold CONTROL LOCK for 3 seconds to turn off Control Lock. For each second Control Lock is held down, the display will count down one second: you will see “3,” then “2,” then “1.”

Drying Results

Clothes are not drying satisfactorily or drying times are too long

- The load is too large and heavy to dry quickly.
 - Separate the load to tumble freely. Loading drum a quarter full or less will improve drying performance and cycle time. Run a high-speed spin cycle.

Lint on load

- Area under door seal is clogged with lint.
 - Gently pull back the rubber door seal and clean lint with the textured side of an affresh® Machine Cleaning Wipe.
- On some models: Drain pump filter is clogged with lint.
 - On some models: Clean the drain pump filter. See “Cleaning the Drain Pump Filter/Draining Residual Water.” This procedure should be performed occasionally.

Dried loads are wrinkled

- The load was not removed from washer at the end of the drying cycle.
 - Remove garments promptly at the end of the drying cycle, or use the FanFresh® option.
- The washer was tightly packed.
 - Dry smaller loads that can tumble freely. Loading drum a quarter full or less will improve drying performance and cycle time. Results may also vary depending on fabric type.

Load too hot

- Load removed before cool-down portion of cycle is complete.
 - Allow the drying cycle to complete the cool-down portion of the cycle before removing the load. If you cancel the cycle before the cool-down portion of the cycle and immediately remove the load, it will be very hot.

Warning

This content is compiled from multiple sources and is provided for reference purposes only. It may not be complete or fully applicable to all situations. If you are unable to resolve your issue, please contact the product manufacturer or an authorized service provider for official support.

Document generated by [ManualsFile](#)

