

Operating your French Door Refrigerator

USING THE CONTROL PANEL

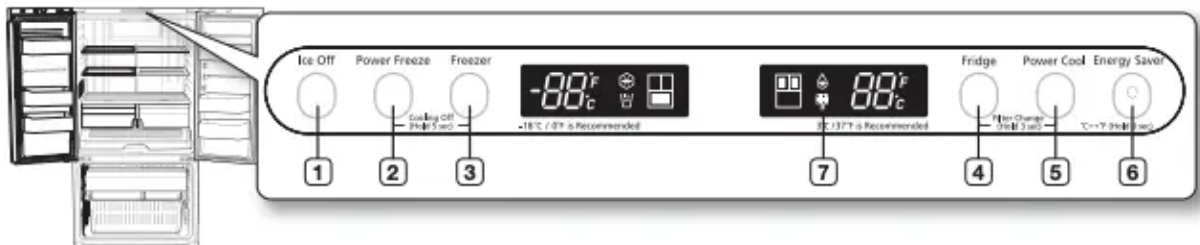

(1) Ice Off Button

Press the Ice off button is you want to turn the ice-maker off.

(2) Power Freeze Button

Speeds up the time needed to freeze products in the Freezer. It can be helpful if you need to quickly freeze easily spoiled items or if the temperature in the Freezer has warmed dramatically (for example, if the door was left open).

(3) Freezer Button

Press the Freezer button to set the Freezer to your desired temperature. You can set the temperature between 5 °F (-15 °C) and -8 °F(-23 °C) .

(4) Fridge Button

Press the Fridge button to set the fridge to your desired temperature. You can set temperature between 34 °F(1 °C) and 44 °F(7 °C) .

(5) Power Cool Button

Speeds up the time needed to cool products in the Refrigerator. It can be helpful if you need to quickly cool easily spoiled items or if the temperature in the fridge has warmed dramatically (For example, if the door was left open).

(6) E. Saver Button

For better energy efficiency, press E.Saver button. However, if condensation occurs on the door, turn the E.Saver function off. Press this button for 3 seconds to switch the temperature units between °C and °F.

(7) Filter Indicator

When the filter indicator light is on, it is time to change the filter. Typically this happens about every 6 months. The filter Indicator will be Red when you have used your water filter for 6 months. The

icon will blink red for several seconds when you open or close the door. The filter indicator will be Off when you insert the new water filter.

COOLING OFF MODE (“OF & OF” CODE ON THE DISPLAY)



This function is for store display refrigerators. It is not for customer use.

CAUTION In Cooling Off Mode, the refrigerator works but doesn't make cool air. To cancel this mode, press the Power Freeze and Freezer buttons at the same time for 5 seconds until a “Ding-dong” sound is heard and the unit will now cool.

WARNING To reduce risk of water damage to your property DO NOT use generic brands of water filters in your SAMSUNG Refrigerator

USE ONLY SAMSUNG BRAND WATER FILTERS. SAMSUNG will not be legally responsible for any damage, including, but not limited to property damage caused by water leakage from the use of a generic water filter. SAMSUNG Refrigerators are designed to work ONLY WITH SAMSUNG Water Filter.

The Filter light turns red to let you know when it is time to change your water filter cartridge. To give you time to get a new filter, the red light comes on just before the capacity of the current filter runs out



Changing the filter on time provides you with the freshest, cleanest water from your refrigerator.

1. Shut off the water supply. Then, turn the water filter (1) about 1/4 turn, counter-clockwise.
2. Pull the water filter (1) from the case filter (2).

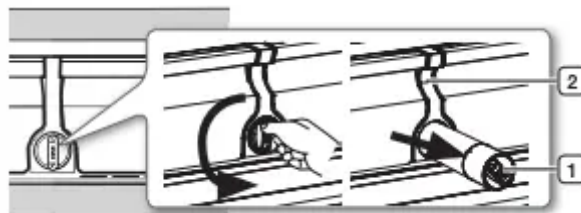

- To change the water filter more easily, shut off the water supply valve.
- Sometimes, it is hard to disassemble the water filter because impurities in the water cause it to stick. If you are having difficulties, grip the water filter firmly and pull it hard.
- When you pull the water filter, a little water can leak from the opening. This is normal.



To minimize the water leaks, keep the filter cartridge horizontal when you pull it.

- To prevent overflow, empty the water filter tray (3) and dry around the filter case (2).

3. Insert the new filter into the filter case (4).

4. Push the filter, and then turn it clockwise until it locks.



• If you have trouble inserting the water filter because of high water pressure, shut off the water supply valve.

- The locked symbol should be lined up with the indicator line.

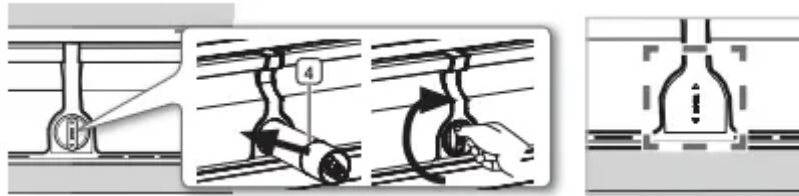

5. After removing the old water filter and installing a new reset the indicator by pressing the “Fridge” and “Power Cool” button simultaneously for about 3 seconds.

6. If you turned off the water supply, turn it back on.



• For a replacement water filter, you can visit your local home Improvement center or contact the Samsung Parts distributor.

- Be sure the replacement water filter has the SAMSUNG logo on the box and on the water filter.

Removing any residual matter inside the water supply line after installing the water filter.

1. Turn ON the main water supply and supply water to the refrigerator.

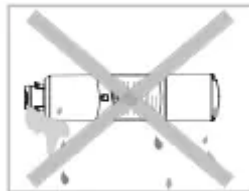

2. Run 1 Gal of water through the dispenser until the water runs clear (approx. 6 to 7 minutes). This will clean the water supply system and remove air from the lines.

3. If after pour 1 Gal the water doesn't turn clear is possible an additional flushing in the household lines.

4. Open the Refrigerator door and make sure there are no water leaks coming from the water filter.



- Be sure to flush the dispenser system thoroughly, otherwise water may drip from the dispenser.
- This means that there is still air in the line.

Reverse Osmosis Water Supply

IMPORTANT :

The pressure of the water supply coming out of a reverse osmosis system going to the water inlet valve of the refrigerator needs to be between 35 and 120 psi (241 and 827 kPa). If a reverse osmosis water filtration system is connected to your cold water supply, the water pressure to the reverse osmosis system needs to be a minimum of 40 to 60 psi (276 to 414 kPa.) If the water pressure to the reverse osmosis system is less than 40 to 60 psi (276 to 414 kPa):

- Check to see whether the sediment filter in the reverse osmosis system is blocked. Replace the filter if necessary.
- Allow the storage tank on the reverse osmosis system to refill after heavy usage.
- If your refrigerator has a water filter, it may further reduce the water pressure when used in conjunction with a reverse osmosis system. Remove the water filter.

If you have questions about your water pressure, call a licensed, qualified plumber.

CONTROLLING THE TEMPERATURE

Basic temperature of Freezer and Refrigerator Compartments

The basic temperature and recommended temperatures of the Freezer and Refrigerator Compartments are 0 °F and 37 °F(or -18 °C and 3 °C) respectively. If the temperature of the Freezer and Refrigerator Compartments are too high or low, adjust the temperature manually

Controlling the Freezer temperature

The Freezer temperature can be set between 5 °F(-15 °C) and -8 °F(-23 °C) to suit your particular needs. Press the Freezer button repeatedly until the desired temperature is shown in the temperature display. Keep in mind that foods like ice cream may melt at 4 °F(-15 °C).

The temperature display will move sequentially from -8 °F(-23 °C) to 5 °F(-15 °C). When the display reaches 5 °F, it will begin again at -8 °F(-23 °C). Five seconds after the new temperature is set, the display will again show the actual current freezer temperature until the new temperature is reached.

Controlling the Refrigerator temperature

The Refrigerator temperature can be set between 44 °F(7 °C) and 34 °F(1 °C) to suit your particular needs. Press the Fridge button repeatedly until the desired temperature is shown in the temperature display.

The temperature control process for the Fridge works just like the Freezer process. Press the Fridge button to set your desired temperature. After a few seconds, the Fridge will begin adjusting towards the newly set temperature. This will be reflected in the digital display.



- The temperature of the Freezer or the Refrigerator may rise from opening the doors too frequently, or if a large amount of warm or hot food is placed in either side.
- This may cause the digital display to blink. Once the Freezer and Refrigerator temperature return to their normal set temperatures, the blinking will stop.
- If the blinking continues, you may need to “reset” the Refrigerator. Try unplugging the appliance, wait for around 10 minutes and then plug the power cord back in.

USING THE COLD WATER DISPENSER

Using the Water dispenser (RF261B, RF26H)

Place a glass underneath the water outlet and push gently against the water dispenser lever with your glass. Make sure the glass is in line with the dispenser to prevent the water from splashing out.

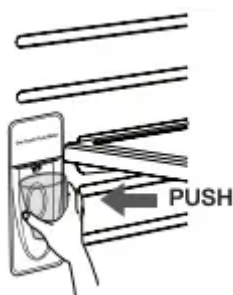

If you have just installed the refrigerator or installed a new water filter, Flush 3 gallons through filter before use (flush approximately 6 minutes). Make sure water flows cleanly before drinking.

CAUTION If you have a long vacation or business trip, close the water valve and shut off the water supply to the Refrigerator. This will help prevent accidental leakages.



• **Water clouding phenomenon**

- All water provided to refrigerators flows through the core filter which is an alkaline water filter. In this process, the pressure in the water that has flowed out of the filter gets increased, and oxygen and nitrogen become saturated. When this water flows out in the air, the pressure plummets and the oxygen and nitrogen get supersaturated so that they turn into gas bubbles. The water could look misty due to these oxygen bubbles. The water may look temporarily cloudy due to these oxygen bubbles. After a few seconds, the water will look clear.
- The water tank's capacity is approximately one third (1/3) of a gallon. Please wait 1 second before removing the cup after dispensing water to prevent spills.

PARTS AND FEATURES

Use this page to become more familiar with the parts and features of the refrigerator

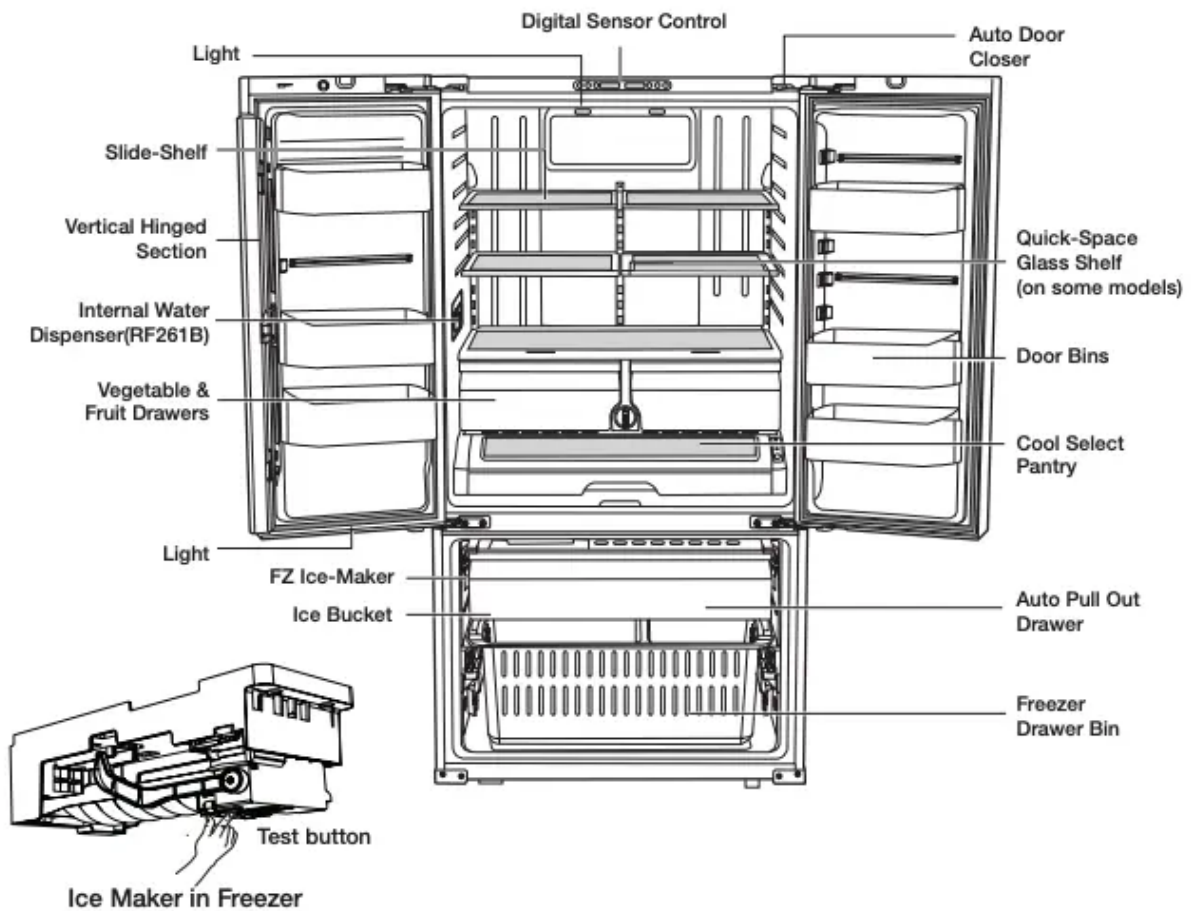

• When closing the door, make sure the Vertical Hinged Section is in the correct position to avoid scratching the other door.

• If the Vertical Hinged Section is reversed, put it back to the right position and close the door.

• Moisture may appear at times on the Vertical Hinged Section.

• The door handle may become loose over time. If this happens, tighten the bolts found on the inside of the door.

• If you close one door with a lot of force, the other door may open.



• When the door opens, the interlock switch automatically turns off the auger motor in the ice maker for safety reasons.



• When the interior or exterior LED lamp has gone out, please contact your service agents.

USING THE COOL SELECT PANTRY

The Cool Select Pantry is a full-width drawer with adjustable temperature control. This pantry can be used for large party trays, deli items, pizza, beverages or miscellaneous items. There is a temperature control which can adjust the amount of cold air allowed into the pantry. The control is located on the right side of the pantry.

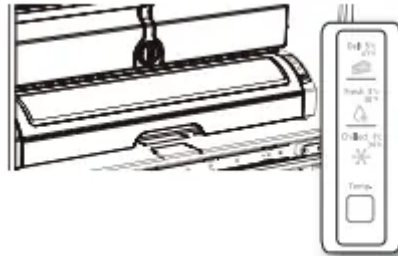

- The Pantry has three modes: The Fresh mode, Chilled mode, and Deli mode. Fresh mode is the default. Press the Temp button repeatedly until the mode you want is lit. Once you select a mode, the temperature will change to match the mode you selected.
- The Pantry temperature may change depending on the number of items inside and where they are located, the ambient temperature, and how often the door is opened.

The Pantry Selection Button

1. When you select “Deli”, the temperature of the pantry will be kept around 41 °F (or 5 °C). This feature helps keep food fresh for a long time.
2. When you select “Fresh”, the temperature of the pantry will be kept around 38 °F (or 3 °C). This feature helps keep food fresh for a longer time.

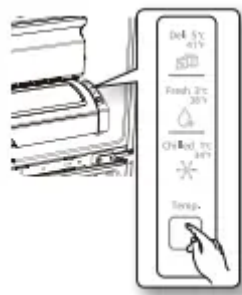

3. When you select “Chilled”, the temperature of the pantry will be kept around 34 °F (or 1 °C). This feature also helps keep meat or fish fresh for a longer time. The table below lists the Pantry modes and the kinds of foods that can be stored safely for each mode.

Deli	Fresh	Chiled
• Pineapples	• cucumbers	• steaks
• lemons	• apples	• hard cheeses
• avocado	• oranges	• cold cuts
• potato	• grapes	• bacon
	• zucchinis	• hot dogs
	• corn	



- Fruits and vegetables may be damaged when the “Chilled” mode is set.
- Do not store lettuce or other leafy produce in this pantry.

CAUTION: Do not store glass bottles in this pantry. If they are frozen, they can break and cause personal injury.

CAUTION In case you put a water bowl without its lid into the pantry, condensation may form around surrounding parts.

REMOVING THE REFRIGERATOR ACCESSORIES

1. Door Bins & Dairy Compartment

• Door Bins

- To remove - Simply lift the bin up and pull straight out.
- To relocate - Slide it in above the desired location and push down until it stops.

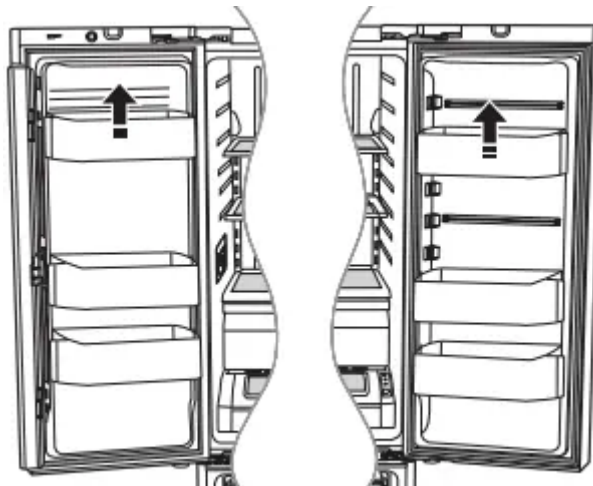

- Injury may occur if the door bins are not firmly assembled.
- Do not allow children to play with the bins. Sharp corners of the bins may cause injury.



Do not adjust a bin full of food. Remove the food first.

To remove dust from the bins - Remove the guard and wash in water.

2. Tempered Glass shelves

- To remove - Tilt up the front of the shelf in the direction shown (1) and lift it up vertically (2). Pull the shelf out.
- To relocate - Tilt the front of the shelf up and guide the shelf hooks into the slots at a desired height. Then lower the front of the shelf so that the hooks can drop into the slots.

CAUTION The Tempered Glass shelves are heavy. Use special care when removing them.

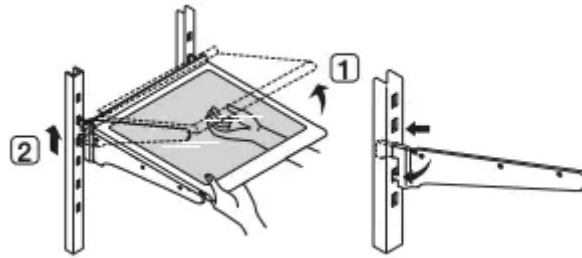

3. Vegetable & Fruit Drawers

- To remove - Pull the drawer out to full extension. Tilt up the front of the drawer and pull straight out.
- To relocate - Insert the drawer into the frame rails and push back into place.

CAUTION The drawers need to be removed before the glass shelf above them can be lifted out.

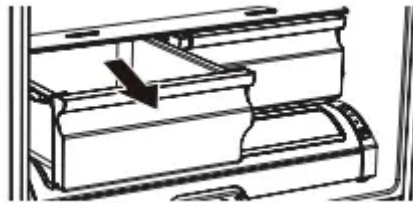

4. Cool select pantry

- To remove the Cool select pantry - Pull the pantry out to full extension. Tilt up the front side of the pantry and pull straight out.



- To relocate the Cool select pantry – Push the rails to the back of the refrigerator. Place the drawer onto the rails and slide the pantry back until it is in place.
- To remove the divider – Pull the pantry completely out to full extension and raise the front side of the divider to unhook it from the rear wall of the pantry, then lift the divider out.

- To relocate the divider - Hook the back of the divider over the rear wall of the pantry and push the divider down.

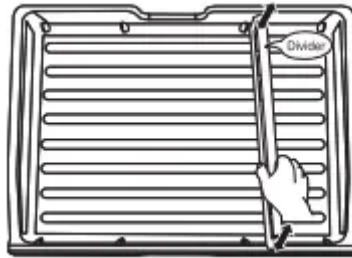

Using the doors

Ensure that the doors close all the way and are securely sealed. When the refrigerator door is only partially open, it will automatically close. But, the door will stay open when opened more than the auto close range and you must close it manually.

REMOVING THE REFRIGERATOR ACCESSORIES

1. ICE BUCKET

- To remove - Lift the ice bucket (1).
- To relocate - Place the ice bucket into the Super extended drawer (2).

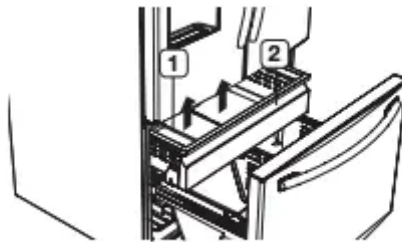

2. Super Extended Drawer

- To remove - Pull the drawer out to full extension. Tilt up the rear of the drawer and lift straight out.
- To relocate - Place the drawer onto the rails (4) by tilting it up. Lower the drawer into place until it is horizontal and slide the Drawer (3) in.



3. Freezer Drawer

- To remove the freezer drawer - Pull the freezer drawer out fully. Tilt up the rear of the bin and lift it out to remove.
- To relocate the freezer drawer - Place the bin into the rail assembly.

CAUTION Do not allow babies or children go inside the freezer drawer. They could damage the refrigerator and seriously injure themselves.

CAUTION Do not sit on the freezer door. The door may break. Do not allow children to climb into the freezer drawer. Do not remove the divider.

WARNING: If trapped inside, children may be injured or suffocate to death.

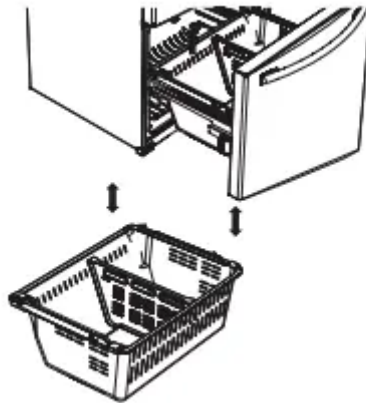

CLEANING THE REFRIGERATOR

Caring for your Samsung French Door Refrigerator prolongs the life of your appliance and helps keep the refrigerator free of odor and germs.

Cleaning the Interior

Clean the inside walls and accessories with a mild detergent and then wipe dry with a soft cloth. You can remove the drawers and shelves for a more thorough cleaning. Just make sure to dry drawers and shelves before putting them back into place.

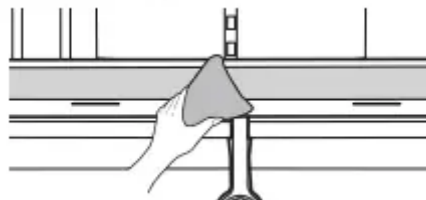

Cleaning the Exterior

Wipe the control panel and digital display with a damp, clean, soft cloth. Do not spray water directly on the surface of the refrigerator. The doors, handles, and cabinet surfaces should be cleaned with

a mild detergent and then wiped dry with a soft cloth. To keep your appliance looking its best, polish the exterior once or twice a year.



CAUTION Do not spray water directly on the refrigerator. Use a clean, damp cloth to clean.

CAUTION Do not use benzene, thinner, or Clorox for cleaning. They may damage the surface of the appliance and may cause a fire.

CAUTION You can erase the printed letters on the display if you apply stainless cleaner directly to the area where the letters are printed.



If the rubber door seals are dirty, the doors may not close properly, and the refrigerator will not operate efficiently. Keep the door seals free of dust or stains by cleaning the doors with a mild detergent and damp cloth. Wipe dry with a clean, soft cloth.

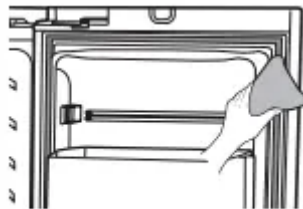

CAUTION Do not clean the refrigerator with benzene, thinner, or car detergent. These substance could cause a fire.

Cleaning the rear side of the refrigerator

To keep cords and exposed parts free of dust and dirt accumulation. Vacuum the rear side of the appliance once or twice a year.

CAUTION Do not remove the back cover (1). You could suffer an electric shock.

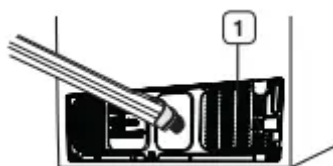

FOOD STORAGE TIPS

Foods	Refrigerator	Freezer	Storage Tips
DAIRY PRODUCTS			
Butter	2-3 Weeks	6-9 Months	Wrap or cover tightly.
Milk	1-2 Weeks	Not recommended	Check date code. Most milk and similar products are sold in date-coded cartons that indicate a product's peak freshness. Re-seal with cap or wrap tightly. Do not return unused portions to original container.
Cream Cheese, cheese food, and cheese spread	2-4 Weeks	Not recommended	Check date code. Keep all cheese tightly packed in moisture proof wrap
Hard Cheese (unopened)	3-4 Months	6 Months	
Hard Cheese (opened)	2 Months	Not recommended	
Cottage Cheese	10-15 Days	Not recommended	
Cream	7-10 Days	2 Months	Check date code. Most yogurt, creams, and similar products are sold in date-coded cartons that indicate a product's peak freshness. Re-seal or cover tightly. Do not return unused portions to original container.
Sour Cream	2 Weeks	Not recommended	
Cream Dips (opened)	1 Week	Not recommended	
Yogurt	10-14 Days	Not recommended	Check date code. Keep covered.
Frozen Yogurt	na	2 Months	
EGGS			
Eggs (uncooked)	3-4 Weeks	Not recommended	Check date code. Store eggs in coldest part of refrigerator and in their original container.
Eggs (cooked)	1 Week	Not recommended	Store in covered container
Leftover egg dishes	3-4 Days	Not recommended	Store in covered container
FRESH FRUITS			
Apples	1 Month	Not recommended	If storing in refrigerator, do not wash fruit before storing. Store in moisture resistant bags or containers. Wrap cut fruits. Some fruits darken when refrigerated.
Bananas	2-4 Days	Not recommended	
Peaches, Melons, Pears, Avocados	3-5 Days	Not recommended	
Berries and Cherries	2-3 Days	12 Months	
Apricots	3-5 Days	Not recommended	
Grapes	2-5 Days	na	
Pineapple (un-cut)	2-3 Days	Not recommended	
Pineapple (cut)	5-7 Days	6-12 Months	
Citrus	1-2 Weeks	Not recommended	Store uncovered.
Juice	6 Days	Not recommended	Check date code and re-seal in original container. Do not return unused portions to original container.
Frozen Juice	Thawing only	12 Months	Check date code. Do not re-freeze.

Foods	Refrigerator	Freezer	Storage Tips
FISH AND SHELLFISH			
Fish			
Fatty Fish (mackerel, trout, salmon)	1-2 Days	2-3 Months	Keep in original wrapper and store in coldest part of refrigerator. Package in vapor-proof and moisture proof wrap for freezer. Freeze at 0 °F (or -18 °C). Thaw in refrigerator or check date code. Freeze in original packaging.
Lean Fish (cod, flounder, etc)	1-2 Days	6 Months	
Frozen or Breaded	na	3 Months	
Shellfish			
Shrimp (uncooked)	1-2 Days	12 Months	To freeze, package in vapor-proof and moisture-proof container.
Crab	3-5 Days	10 Months	
Cooked Fish or Shellfish	2-3 Days	3 Months	
MEAT			
Fresh, Uncooked			
Chops	2-4 Days	6-12 Months	Check date code for use. Store in coldest part of refrigerator in original packaging. Package in moisture-proof and vapor-proof container for freezing. Recommended refrigerator temperature 33 °F to 36 °F (or 1 °C to 2 °C) and freezer temperature 0 °F to 2 °F (or -18 °C to -16 °C)
Ground	1 Day	3-4 Months	
Roast	2-4 Days	6-12 Months	
Bacon	1-2 Weeks	1-2 Months	
Sausage	1-2 Days	1-2 Months	
Steak	2-4 Days	6-9 Months	
Poultry	1 Day	12 Months	
Lunch meat	3-5 Days	1 Month	
Cooked			
Meat	2-3 Days	2-3 Months	Check date code for use. Store in coldest part of refrigerator in original packaging. Package in moisture-proof and vapor-proof container for freezing.
Poultry	2-3 Days	4-5 Months	
Ham	1-2 weeks	1-2 Months	

Sources: American Meat Institute Foundation. 1994. Yellow pages: answers to predictable questions consumers ask about meat and poultry. American Meat Institute Food Marketing Institute. 1999. The food keeper. Food Marketing Institute, Washington, D.C. Freeland-Graves, J.H. and G.C. Peckham. 1996. Foundations of food preparation, 6th ed. PrenticeHall, Inc. Englewood Cliffs, NJ. Hillers, V.N. 1993. Storing foods at home. Washington State University Cooperative Extension, Pullman, WA. Publ. EB 1205.

National Restaurant Association. 2001. Be cool-chill out! Refrigerate promptly. National Restaurant Association Education Foundation ¼ International Food Safety Council, Washington, D.C. USDA. 1997. Basics for handling food safely. U.S. Department of Agriculture, Food Safety and Inspection Service, Washington, D.C.

Troubleshooting

The refrigerator does not work at all or it does not chill sufficiently

- Check if the power plug is properly connected.
- Check if the set temperature on the digital display is warmer than the freezer or fridge inner temperature. If it is, set the refrigerator colder.
- Is the refrigerator in direct sunlight or located near a heat source?
- Is the back of the refrigerator too close to the wall, preventing proper ventilation?

The food in the fridge is frozen.

- Check if the set temperature on the digital display is too low.
- Try setting the refrigerator to a warmer temperature.
- Is the temperature in the room too low? Set the refrigerator warmer.
- Did you store the food which is juicy in the coldest part of the refrigerator? Try moving those items to the other shelves in the fridge instead of keeping them in the colder areas or bins

You hear unusual noise or sounds.

- Check if the refrigerator is level and stable.
- Is the back of the refrigerator too close to the wall, preventing proper ventilation? Try moving the back of the refrigerator at least 2 inches from the wall.
- Was anything dropped behind or under the refrigerator?
- A “ticking” sound is heard from inside the refrigerator. This is normal and occurs because various accessories are contracting or expanding according to the temperature of the refrigerator interior.
- If it sounds as if something is hitting something else inside the refrigerator, this is normal. The sound is caused by the compressor operating at high capacity.

The cabinet-door sealing area of the appliance is hot and condensation is occurring.

- Some heat is normal as anti-condensators are installed in the vertical hinged section of the refrigerator to prevent condensation.
- Is the refrigerator door ajar? Condensation can occur when you leave the door open for a long time.

Ice Maker is not producing ice.

- Did you wait for 12 hours after installation of the water supply line before making ice?
- Is the water line connected and the shut-off valve opened?

- Did you manually stop the ice making function?
- Is the freezer temperature too warm? Try setting the freezer temperature lower.

You can hear water bubbling in the refrigerator.

- This is normal. The bubbling comes from refrigerant circulating through the refrigerator. There is a bad smell in the refrigerator.
- Check for spoiled food.
- Foods with strong odors (for example, fish) should be tightly covered.
- Clean out your freezer periodically and throw away any spoiled or suspicious food.

Frost forms on the walls of the freezer.

- Is the air vent blocked? Remove any obstructions so air can circulate freely.
- Allow sufficient space between the stored foods for efficient air circulation.
- Is the freezer drawer closed properly?

Water dispenser is not functioning.

- Is the water line connected and the shut-off valve opened?
- Has the water supply line tubing been crushed or kinked?
- Make sure the tubing is free and clear of any obstruction.
- Is the water tank frozen because the fridge temperature is too low? Try selecting a warmer setting on the Digital display.

Auto close system does not work with the freezer door.

- Is there an imbalance between the right and left parts of the door?
- Open and close the door smoothly 1~2 times. After you do this, the auto close system usually works properly again.
- Try opening the door smoothly to avoid unbalancing the right and the left part of the door.

Warning

This content is compiled from multiple sources and is provided for reference purposes only. It may not be complete or fully applicable to all situations. If you are unable to resolve your issue, please contact the product manufacturer or an authorized service provider for official support.