

Before you do your first wash

Before you start, it is a good idea to go through the following checklist:

1. Have the packaging and transit bolts been removed?
2. Is the drain hose threaded through the 'U bend' (with no more than 20mm extended) and hooked into your standpipe or tub, or attached to a spigot?
3. Is the cold hose connected to the cold valve? Has the tap been turned on and connected to the washer dryer?
4. Is the machine correctly levelled? Are the feet locked and cabinet corners clear of the floor and walls?
5. Has the power cord been connected to an appropriate power supply and the power turned on?
6. Has the installation test cycle been performed?
7. We recommend you complete your first cycle with a half-load amount of detergent and without a load in order to remove any residues remaining in the machine from the manufacturing process.

IMPORTANT! You must ensure all 4 transit bolts have been removed from your washer dryer before you start using it. If the transit bolts are not removed, they will damage your washer dryer and **YOUR MANUFACTURER'S WARRANTY WILL BE COMPROMISED.**

GETTING STARTED QUICKLY

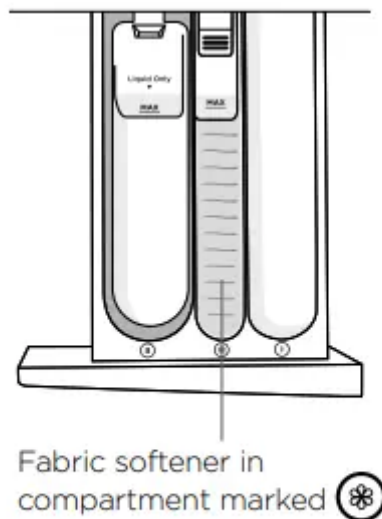
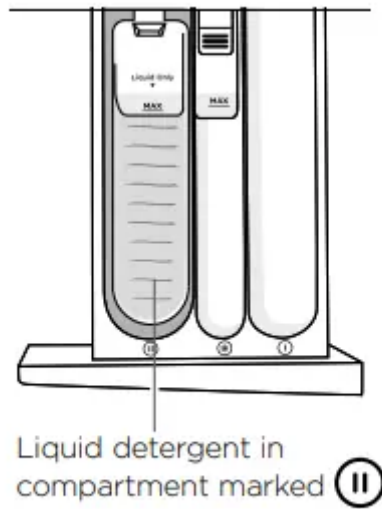



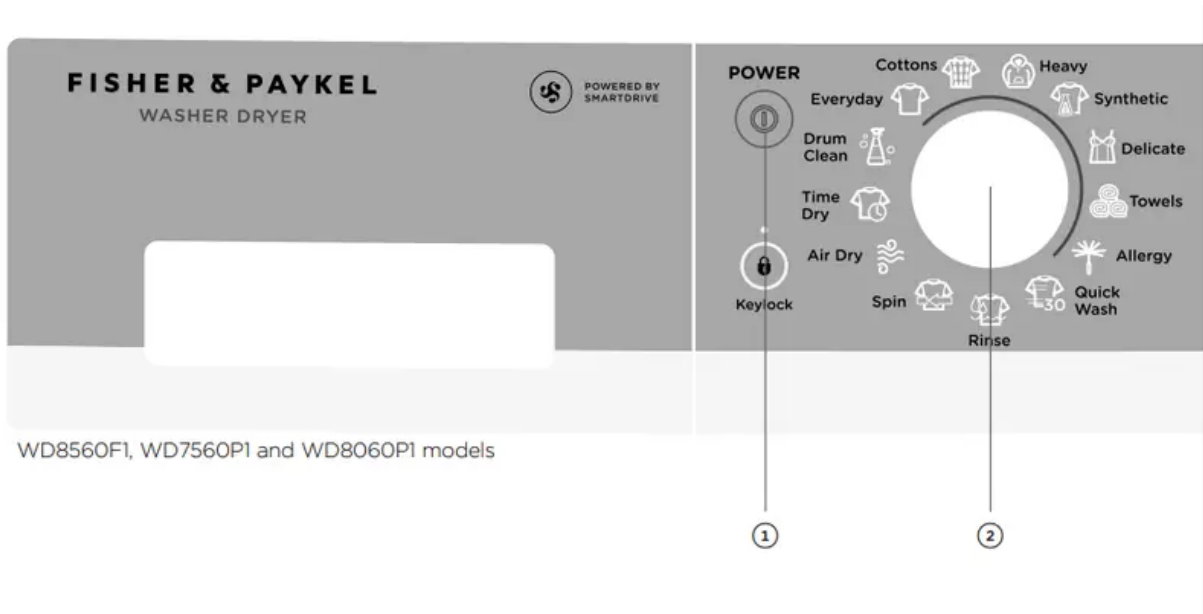

- Sort your washing carefully. Separate white/light colours from dark colours. Wash new, highly coloured and dark coloured items separately to prevent dye transfer. Refer to the 'Sorting and loading' section.
- Load your clothes individually into the drum. Close the door.
- Use 'Top Loader/Front Loader', 'Low Suds', 'High Efficiency' or 'HE' powder, liquid or pods. Pour liquid detergent into the correct compartment in the dispenser drawer marked **||**. If you wish to use powdered detergent you MUST remove the liquid detergent insert by firmly grasping and twisting the left hand side of the internal compartment and pulling upwards. If you are using detergent pods place them at the back of the drum before adding your clothing. For more information on detergent refer to the 'Detergent and fabric softener' section.

- If you wish to use fabric softener, pour it in the compartment marked with a . For more information on fabric softener refer to the 'Detergent and fabric softener' section.

IMPORTANT! Fabric softener should not be used if you have selected the 'Quick Wash 30' cycle.



1. Press 'POWER' to activate your washer dryer.
2. Select your wash or dry cycle by turning the SmartTouch™ Control Dial.
3. If you are wanting to perform a wash, dry or continuous wash and dry cycle touch the 'Select' button to change to the desired cycle functionality.
4. Choose your wash or dry options (if you wish to select options different from the default options for the cycle).
5. Touch  to start the cycle.
 - If you make an invalid selection the washer dryer will beep to alert you.
 - When the cycle finishes, your washer dryer will perform end of cycle beeps and then turn off automatically.
 - If you wish to stop your washer dryer at any point during a wash or dry cycle simply touch  to pause the cycle. There may be a slight delay while the drum comes to a stop, then the door will unlock. Under certain conditions however the door will remain locked for safety reasons (refer to the 'Safety features' section).
 - If you wish to cancel or change the wash cycle once a cycle has started, simply touch the  button then select the new cycle. Touch  to restart the washer dryer.

IMPORTANT!

- For the best fabric and colour care, remove your clothes as soon as the cycle has finished.
- Failure to follow the advice in this guide may result in damage to your garments and your expectations of wash and dry performance may not be met.
- Sort and load items into the drum, ensuring no items are in the way of the door. Close the door (you will hear it click).

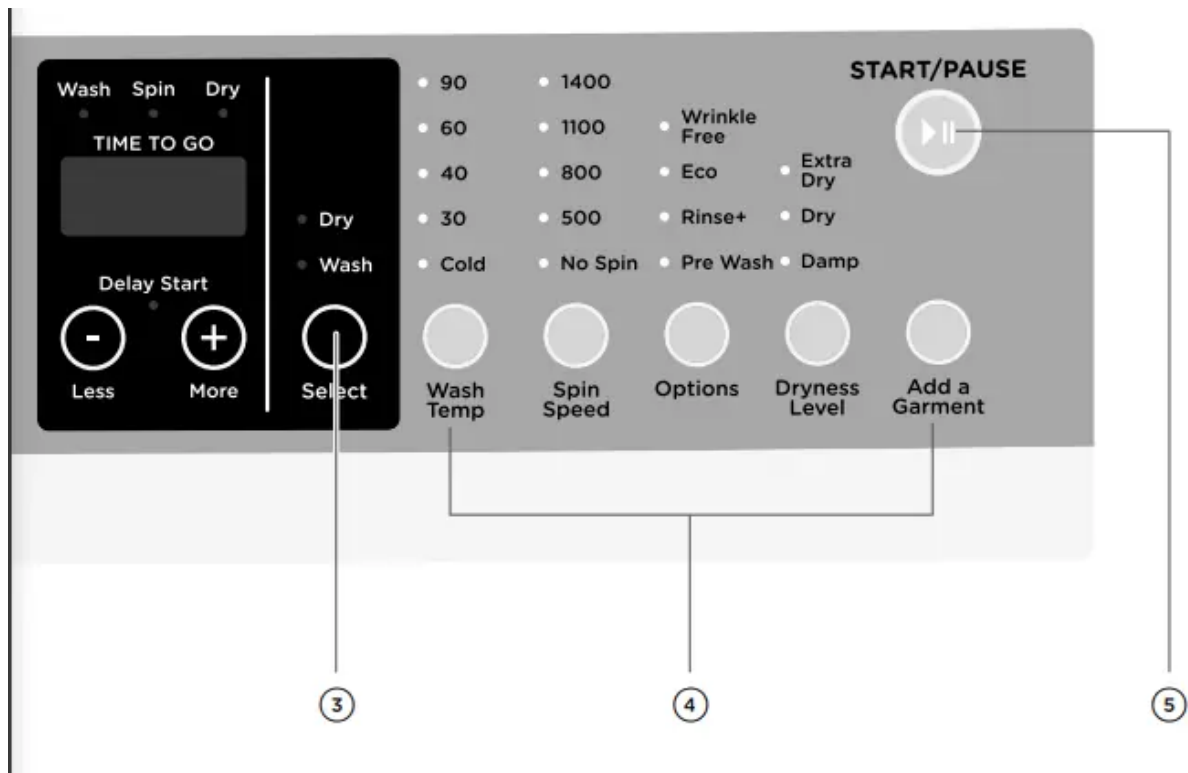

WASHER DRYER CONTROLS

- SmartTouch™ Control Dial: The SmartTouch™ Control Dial provides easy and efficient wash and dry cycle selection. As you rotate the dial, the icon of the wash or dry cycle selected will be illuminated, while the default settings for that cycle will be illuminated on the right side of the control panel.



SmartTouch™ Control Dial

- SmartTouch™ buttons: The smooth, easy clean buttons enable simple selection of options with lights clearly showing the selections you are making.



SmartTouch™ buttons

- Digital display screen: The digital display screen provides an estimate of how long the wash or dry cycle has to go. If you have programmed a 'Delay Start', the time remaining until the cycle will start will be displayed here, along with any messages to help you with the overall running of your washer dryer (eg user warnings).

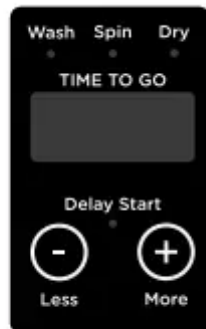

Digital display screen

- Progress lights: The progress lights indicate what part of the cycle the washer dryer is currently performing (wash, spin, dry). Two lights are on at the beginning of a wash cycle and all three lights are on at the beginning of a continuous wash and dry cycle. The light for the current part of the cycle flashes, and each one goes out when that part of the cycle is complete.



Progress lights

- Keylock mode: 'Keylock' can be used to lock the buttons on your washer dryer. This will avoid accidental button pushes. For more detail please refer to the 'Wash and dry cycle options' section.



'Keylock' mode

- Drum light (WD8560F1 model only): Your machine has a drum light to help assist you when loading and unloading your washer dryer. When you press 'POWER', the LED light in the drum will turn on. After 2 minutes it will automatically turn off. At the end of the cycle, the drum light will turn on again for 5 minutes to help aid unloading.
- Time to go: Your washer dryer displays approximately how many minutes are remaining in the cycle you are running, so that you can tell at a glance when your laundry will be finished. Please be aware that a number of factors can influence the overall cycle time, eg the water flow rate, water pressure, load size, cycle, fabric type of garments, wetness of the load and options selected. Therefore, cycle times will vary, even during a cycle. Unexpected events in a wash cycle (eg out of balance, oversudsing) can lengthen the cycle time.

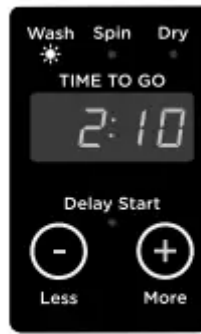

Time to go

- Wash and dry options: This button controls the functionality of your washer dryer. If you are wanting to perform an individual wash only cycle please select 'Wash'. If you are wanting a continuous wash and dry cycle please select both 'Wash' and 'Dry'. This cycle will seamlessly continue from wash to dry so your washing is completed in one easy step. If you are wanting to perform an individual drying cycle please select 'Dry'.



Wash and dry options

- Wash only: If performing a wash only cycle, the approximate wash time will be displayed and will count down until cycle completion.



Wash only cycle

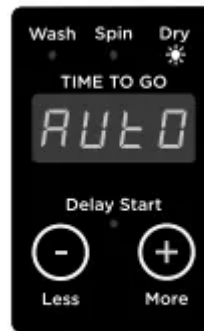

Dry only cycle

Dry only:

- If performing a dry only cycle (eg 'Everyday', 'Cottons', 'Heavy', 'Delicate', 'Synthetic', 'Towels' or 'Allergy') the machine will display **AUTO** until the washer dryer has determined the time it will take to dry each specific load. **AUTO** will be replaced by the number of minutes the cycle you are running has remaining. Once your washer dryer has achieved the dryness setting you have selected, it will go into a cool down phase and display **COOL** until the load reaches a safe temperature, and then ends the cycle. In some cases when running a dry only cycle the machine will display **AUTO** and will not calculate a remaining time to go. This is normal and can occur due to a number of different factors, ie running back to back drying cycles.
- If you have chosen an 'Air Dry' cycle, your washer dryer will display a time to go until the end of the cycle is reached. If you select a 'Time Dry' cycle the machine will display the time to go until the **COOL** down period is reached and the cycle ends.
- Wash and dry: If performing a continuous wash and dry cycle your machine will display an estimated cycle time. The time depends on the cycle and options chosen, and the average time to dry a typical load size is added to the wash time. Once the wash cycle

has finished the machine will display **AUTO** and recalculate the drying time depending on a number of factors. The estimated time to go will then be displayed until the cool down phase begins.

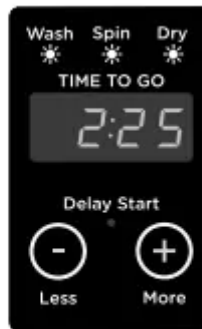

Wash and dry cycle

SAFETY FEATURES

Door lock

- The door of your washer dryer will lock once you touch **▶||** until the machine beeps at the end of the cycle, ensuring safety for you and your family while your machine is operating.
- Simply touch **▶||**, the machine will pause and the door will automatically unlock if the conditions inside the washer dryer are safe. The **▶||** button and time to go will flash on the screen while the washer dryer is paused. Close the door and touch **▶||** to resume the cycle. If items of clothing have been added or removed from your washer dryer the displayed time to go may differ from the actual cycle time. If the machine is in the middle of a wash or dry cycle and you are wanting to add or remove any items please refer to the 'Add a Garment' section below.
- Note: the door will remain locked if the temperature inside the washer dryer is above 60°C and/or the water level is above the bottom of the door seal (a warning will be displayed in these circumstances, refer to 'Before you call for service').

Add a Garment

- The 'Add a Garment' function can be used to interrupt a cycle to add or remove a garment at any time during the wash or dry part of the cycle (as long as the wash temperature selected is lower than 60°C). If 'Add a Garment' is pressed during a drying cycle the machine will perform a cool down until a safe temperature is reached then the door will unlock. Refer to 'Wash and Dry Cycle Options' for more information.

Opening the door during a power failure

- If there is a power failure during a wash or dry cycle your washer dryer will stop and the door will remain locked. You can manually unlock the washer dryer door to remove your clothes by opening the pump filter cover at the bottom right of your washer dryer. Simply place a coin or key in the slot and tilt it upwards to lever the cover open, then pull the door release tab.

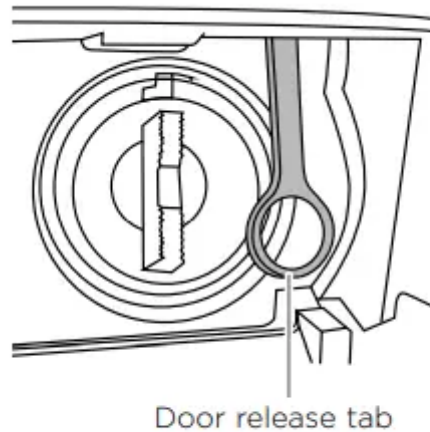

Manual door opening mechanism

IMPORTANT! Do not attempt to do this if the water level in the drum is above the level of the door. When power is restored you will need to restart your machine by simply pressing 'POWER'. The washer dryer will remember where in the cycle it was up to.

Your washer also has the following protective measures:

- Flood protection — turns off valves and turns pump on if a flood condition is detected.
- Out-of-balance protection — stops and redistributes the load if an unbalanced load condition is sensed, and/or slows the spin speed to compensate.
- Excess suds protection — pauses to allow suds to break down before continuing the cycle.

SORTING AND LOADING

When preparing your washer or dryer load there are some important things to consider:

Sorting

- It is best that you sort your garments before placing them into the washer dryer. Sort into loads of similar items, and loads that will take similar times to dry. Always separate coloured items from whites, especially when they are new.
- Some soils, like mud and blood are best washed in cold water. Oily soils (eg some food stains or makeup) are best washed in warm water.

- Look for care label instructions on your clothes as this will inform you of wash and dry recommendations.
- Wash and dry fine, delicate fabrics (eg synthetics and polyester-cotton shirts) separately from thick, heavy fabrics (eg towels, flannelette sheets). This prevents damage and the possibility of some items becoming over-dried whilst others are still damp. It also helps to extend the life of your clothing and linen.
- We recommend removing your clothes from the washer dryer after the completion of a wash or dry cycle to help decrease the chance of wrinkles, and dye transfer from coloured items to white items.
- Wash and dry towels on the towels cycle to reduce lint transfer onto other clothing items and to efficiently wash and dry towels.
- Items of clothing with screen-printing should be turned inside out to prevent damage to the print. Also garments with hooks or zippers should be fastened and where possible, turned inside out.
- In the following table (next page) there are recommendations for what cycles and settings you may wish to wash and dry different items on, and suggestions for special wash and dry requirements.

IMPORTANT! Over loading the washer dryer with a dry load above this line on any drying cycle can lead to poor drying performance.



Before you load

- Check pockets for items that could damage your clothes or get caught in the washer dryer.
- Close zippers, hooks and eyes, and other fastenings (ie fasten the opening of duvet/ doona covers), and remove loose bra wires. All these can damage both your washer dryer and your clothes.

- Place delicate items, such as lingerie, in a mesh laundry bag if performing a wash only cycle. If performing a continuous wash and dry cycle or an individual dry cycle it is recommended not to use a mesh bag to ensure good drying performance.
- Pre-treat any stains, taking care not to spray pre-treaters on your washer dryer as they can cause damage to the plastic surfaces.

Loading

- It is more efficient to wash larger loads, so try to collect enough items to loosely fill the drum when the items are dry.
- If performing a continuous wash and dry cycle or an individual dry cycle please take note of the dryer capacity to ensure the appropriate dryness level is reached. Note: the dryer capacity is less than the wash capacity.
- Before performing a continuous wash and dry cycle or an individual dry cycle, garments should be fluffed up and loaded evenly to minimise creasing and wrinkling, and to ensure the load is dried evenly. Make sure there is plenty of room for the garments to tumble freely while drying.
- It is a good idea to wash and dry 'permanent press' types garments (eg business shirts) together on a separate cycle with the 'Wrinkle Free' option on. This will help reduce wrinkling and the need for ironing.
- If you run a wash cycle then manually want to select a drying cycle, fluff up the items in the machine before starting a drying cycle.
- Hint: For a drying cycle, load the washer dryer in terms of the space the garments take up when dry, rather than wet. Do not overload a drying cycle as it may damage your washer dryer and clothes.

To reduce tangling

- Load items individually when performing a drying cycle.
- Only dry bedding loads of up to a maximum of 5kg or 4kg in the dryer (depending on the model).

To reduce creasing

- If performing a continuous wash and dry cycle remove items from the dryer as soon as the drying cycle is completed.
- If the items are going to be left in the machine after any cycle, select 'Wrinkle Free' to help reduce creasing.
- Shake clothes out after a wash cycle and before performing a dry cycle and load individually to help items dry evenly.
- Launder permanent press garments separately, eg business shirts.
- Allow enough room in the dryer for clothes to tumble freely.

- Hang garments as soon as the dryer cycle is complete to reduce the need for ironing

Lint

- Some items are lint givers, while others are lint collectors. Always dry lint givers and collectors separately.
- Delicate or easily damaged items (eg silk garments, nylon stockings, fine fabrics, delicate embroidered fabrics, garments with metal accessories, sleeping bags or other down items) should be dried separately, using the 'Delicate' cycle

LINT GIVERS	LINT COLLECTORS
Towels	Synthetics eg polar fleece
Flannelette sheets	Corduroy
Nappies	Polyester cottons

IMPORTANT!

- Do not overload your washer dryer beyond its rated capacity.
- Never put dripping wet clothes on top of the washer dryer as excess water may cause an electrical hazard.
- Please do not under any circumstances wash or dry an electric blanket or any other electrical, plastic or rubber items in your washer dryer unless the care label specifically states it is safe to do so. Never dry these items at high temperatures.
- Do not wash or dry curtains in this washer dryer, as sunlight makes them brittle and they may disintegrate during washing or drying.

Note: this washer dryer is designed to be used as a washer then a dryer, please keep dry only cycles to a minimum to ensure lint is flushed out of the machine between drying cycles.

CARING FOR YOUR WASHER DRYER

When you have finished using your washer dryer

- Unplug the machine from the power socket.
- Wipe around the door and in the rubber gasket to remove any remaining water/ condensation, lint and foreign matter.
- Turn off the taps to prevent the chance of flooding should a hose burst.

Cleaning your washer dryer

- Before you start cleaning your washer dryer, ensure that it is disconnected from the power (ie unplug the machine from the power socket).

Cleaning the control panel and outer surfaces of the washer dryer

- Use a soft damp cloth to wipe all surfaces, then wipe dry. Avoid using chemical or scouring cleaners, as these will damage the paint and plastic surfaces of your washer dryer.

Cleaning the detergent dispenser drawer

- Wipe out the detergent dispenser drawer with a damp cloth. Clean it regularly, especially if you use fabric softener. To remove the drawer, pull it open, push down on the tab in the fabric softener compartment and pull out. Rinse it out under warm water and replace.

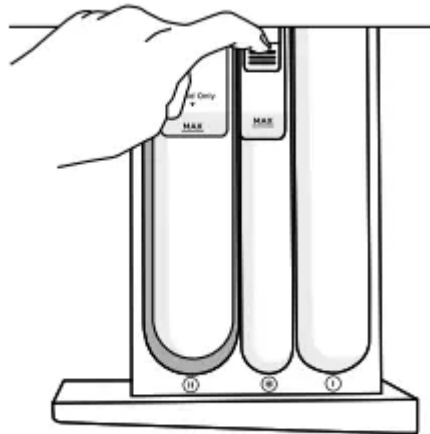

Removing the dispenser drawer for cleaning

Cleaning the inside of your washer dryer



'Drum Clean' cycle

- It is important that you regularly clean the inside of your machine using the 'Drum Clean'





cycle. After 100 cycles the icon will flash every time you turn your washer

dryer on to remind you to do this. If your washer dryer starts to smell this is a sign that you should complete a 'Drum Clean' cycle. We recommend that you do not have any items in the washer dryer when you run this cycle.

Cleaning steps

1. Add approximately 2 full scoops of a good quality powdered detergent directly into the

main wash detergent compartment of the dispenser drawer (marked ) or use a drum cleaning product specifically designed for front loading washing machines (follow manufacturer's instructions).

2. Press 'POWER' to turn your machine on and select the 'Drum Clean' cycle.
3. Touch  to start the cycle (refer to the 'Wash and dry cycles' section).

Cleaning the drum and the door

- Use a soft damp cloth to wipe the door, cleaning any water marks or residue off it.
- Wipe the rubber seal around the door. Remove any items or lint accumulating in the bottom of the seal catchment and wipe out any water accumulated here. If this is not cleaned out, unpleasant odours will develop.
- If the drum has any residual dirt or lint stuck to it, remove this and wipe the drum clean. Do not leave any metal objects in the drum as these may rust and cause staining.
- WD8560F1 has a self cleaning door flush that directs a portion of the rinse water over the door during various stages of the cycle to help to clean hair and insolubles from the inside of the door and surrounding parts. We still recommend that you manually clean it with a soft cloth periodically as per the instructions above.

Cleaning the pump filter

The pump has a filter to trap foreign objects that enter the washer dryer along with clothing. The pump filter can be accessed from the front of the washer dryer.

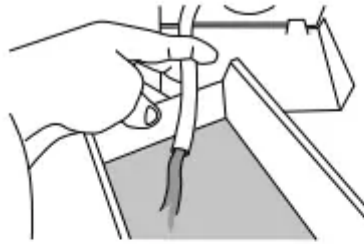

Drain residual water



Replacing filter

To clean the filter: This should be cleaned out approximately once a month.

1. Turn the power off and unplug the machine.
2. Use a coin to open the filter cover. Place the edge of the coin into the slot and tilt upwards whilst levering the cover open.
3. Unhook the pump outlet hose and pull it out (about 150mm). Remove the plug and allow any water (approximately 250ml) to drain into a shallow dish.
4. After the draining process is complete, replace the plug into the hose and refit the hose back into the housing.
5. Remove the filter by turning anti-clockwise. Clean and rinse under a tap.
6. Replace the filter by turning clockwise until the white mark on the filter is in line with the white line on the pump housing.
7. Make sure the propeller is freely moving at the back of the filter cavity, remove any foreign objects
8. Close the filter cover.

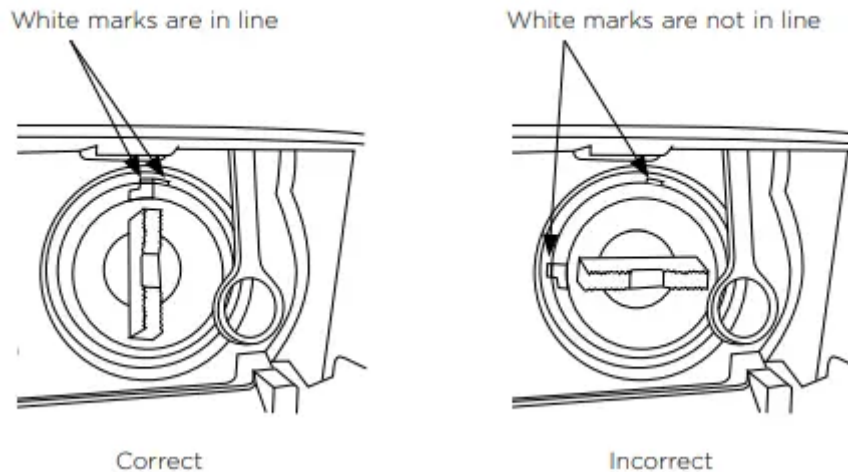

White mark on filter must be in line with white line on pump housing

Cleaning the hose

- The hose has a filter in it, preventing any solid contaminants in the water entering your washer dryer. Occasionally you should disconnect the water inlet hose where it connects to the taps, check for any build up of dirt and wash this out.

Nappy sanitisers/bleach

- Nappy sanitisers and bleach are very corrosive to metal surfaces. DO NOT tip the contents of a nappy bucket into your machine. Rinse and wring items out thoroughly before placing them in the machine.

Moving your washer dryer

- If you need to move your washer dryer a considerable distance (eg moving house), remember to replace the transit bolts before moving it. These will protect internal components of the washer dryer from damage.
- To replace the transit bolts, pull out the bolt-hole covers at the back of the machine. Push the transit bolt rubber grommets and plastic spaces into the hole left and tighten it with the spanner provided with the product.
- Make sure any water in the washer dryer is drained out. This can be done by cleaning out the pump filter (refer to 'Caring for your washer dryer' section 'Cleaning the pump filter').

IMPORTANT!







- Leave the door to your washer dryer open when it is not in use to allow the washer dryer to dry out, otherwise it will develop unpleasant odours. When leaving the door open like this, it is extremely important that children and pets are kept away from the washer dryer so they cannot be accidentally trapped inside it.

- Aside from the detergent dispenser, water hose, and the pump filter, no other parts are designed to be removed from the machine for cleaning. Do not attempt to remove any other part of the machine.

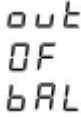
Troubleshooting

User warnings

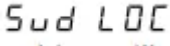
- Your washer dryer is capable of diagnosing a number of its own problems. It will sound a continuous series of beeps and display a code when it has a problem that you can correct yourself. All control panel lights will turn off and the code will be displayed to inform you what the problem is. To stop the beeps, press any button on the control panel. Do not try to continue washing or drying once you stop the noise. You must address the problem the washer dryer is alerting you to.
- Check this chart before you call for service.

PROBLEM	DISPLAYED AS	WHAT TO DO
Water is not getting to the machine		<p>Check the tap has been turned on.</p> <p>Check the hose connection.</p> <p>Check the inlet hose filter is not blocked, the hose is not kinked and is attached correctly.</p> <p>Check that the drain hose is not too low or pushed into the standpipe too far. This will cause the water to siphon out of the machine.</p> <p>Check the cold water temperature does not exceed the 35°C temperature requirement.</p> <p>Check the water flow rate. It maybe too low.</p>
Wash load is out of balance.		<p>Touch  to try the spin again.</p> <p>If the out of balance persists, pause the cycle, manually redistribute the load and touch  to spin again. If necessary, stop the cycle, select 'Spin' and touch .</p> <p>If the problem persists, check the machine is correctly levelled.</p>
Too many suds.		<p>Machine will stop and flash  while waiting for suds to dissipate. The machine will not beep during this time. When the suds have dissipated, the machine will automatically restart.</p> <p>If a suds event has occurred during a cycle the machine will also display this warning at the end of the cycle, to alert you that this has occurred. This may help to explain any reduction in performance.</p> <p>Check you are using a suitable detergent.</p> <p>Check you are not overdosing the detergent.</p> <p>Check the standpipe height for the drain does not exceed 1200mm.</p>
Machine is too hot.		<p>The temperature in the drum is over 60°C therefore it is not safe to open the door. Wait until the temperature drops below 60°C then the machine will open the door.</p>

Door is locked.		<p>The temperature in the drum is over 60°C therefore it is not safe to open the door. Wait until the temperature drops below 60°C.</p> <p>Check the water level in the drum. If the level is above the bottom of the door seal, the door cannot be opened. Use the 'Add a Garment' button if you wish to add or remove items.</p> <p>If the drum is still moving, wait for it to stop before attempting to open the door.</p>
Door is open.		<p>Close the door fully and touch .</p> <p>Try opening and closing the door again.</p> <p>Reposition the load, make sure the load is correctly in the drum and that protruding items are not stopping the door from closing.</p>
The pump filter is blocked.		<p>Machine will stop and flash if the water is not draining out of the drum. This can be caused by foreign objects or a build up of lint in the pump or filter. Clean the filter, refer to 'Caring for your washer dryer' on how to remove the filter (if the machine is in the middle of a cycle and has a drum fill of water a lot of water might come out).</p> <p>Run a 'Drum Clean' cycle to flush out any residue or lint that may be caught in the machine after cleaning out the filter. If this happens often, clean the filter out regularly.</p>
Machine is cooling down.		<p>The machine is performing a cool down to reduce the temperature inside the drum so it is safe to open. This time can vary depending on a number of factors. Let the machine perform this cool down period so it is safe to access items of clothing.</p> <p> will be displayed at the end of a drying cycle, if the 'Add a garment' button is selected and if is pushed.</p>

Once you have addressed the user warning try using your washer dryer as per usual. If the symptom persists, call your Fisher & Paykel trained and supported service technician.

FAULT CODES

When a continuous series of beeps is sounded, all the lights turn off on the control panel and a number appears on the display, a fault has occurred. The washer dryer will automatically enter this



mode if a fault occurs. The fault code will be displayed as followed by a number on the digital display. To stop the sound, touch any button and perform the following steps:

1. Turn your machine off at the power point.
2. Wait one minute and turn it back on.
3. Check your machine is correctly levelled (refer to page 12).
4. Remove your load.
5. Perform a 'Rinse' cycle.
6. If the fault re-occurs repeat steps 1 and 2.
7. If the machine still will not work you will be required to call a Fisher & Paykel trained and supported service technician to arrange service (refer to the 'Customer Care' section). Record the fault code number displayed and the serial number of your washer dryer (located on the rear of the machine, and/or above the drum opening when the door is open) before calling. The fault code will indicate to the Fisher & Paykel trained and supported service technician what the problem could potentially be.

If a fault code is being displayed, you can still turn your washer dryer off by pressing 'POWER'.

The following is a list of problems you may encounter when using this appliance and some suggestions that may help to correct the problem. If you still have problems, please contact your Fisher & Paykel trained and supported service technician.

Solving general operating problems

PROBLEM	POSSIBLE CAUSES	WHAT TO DO
Washer dryer not turning on.	Electrical cord not plugged into a power socket.	Plug cord into a power socket.
	Power not switched on at the wall.	Switch the power on at the wall. Then touch 'POWER'.
	Household power supply not working.	Try plugging another electrical appliance into the same socket. Turn off the power at the power point. Unplug the washer dryer from the power socket. Wait 60 seconds, plug it back in, turn it on and try again.
	'Keylock'  may be activated.	Touch and hold the 'POWER' button for 2 seconds
Touching does not start filling or drying.	Washer dryer door not closed properly	Open and reclose door.
	The washer dryer has detected a fault.	Check if a code is being displayed on the panel.
	Cold tap turned off.	Check that the cold tap is turned on
	Blocked hose filter.	Check the tap end of the inlet hose for blockages.
	Inlet hose leaking, twisted or damaged.	Check the inlet hose for leaks or damage. Check that the inlet hose is not twisted.
	Faulty water supply.	Check the cold tap is connected to the machine and is working.
	'Delay Start' may be set.	Refer to page 35.
Washer dryer is paused.	 light is flashing.	Touch the  button to resume the cycle.
Washer dryer stops working mid cycle.	The washer dryer has detected a fault.	Refer to pages 40 – 42.

	Power or water failure.	Check the power and/or water is working correctly.
	Washer dryer has been paused.	Touch the  button to continue.
	Too many suds.	Washer dryer is waiting for suds to dissolve before continuing the cycle.
Vibrating.	Transit bolts left in place.	Ensure transit bolts are removed prior to use of the product
	Washer dryer may not be level.	Ensure washer dryer is installed on an appropriate surface and levelled correctly
	Load is out of balance.	Wash an average sized load rather than a smaller load or a single item. Washing or drying one item at a time is not recommended as it is difficult for the washer dryer to balance a single item during spin.
Small puddle of water from under the machine.	Inlet hose or drain hose leaking.	Check inlet hose and the drain hose are correctly attached and not damaged.
	Lots of suds.	Suds may have leaked and then dissolved.
	Detergent dispenser blocked.	Clean detergent dispenser drawer
	Detergent dispenser drawer not fully closed.	Close detergent dispenser drawer fully and ensure it remains closed during the cycle.
	Damage to door seal.	Check seal inside door for damage. If it sustains any damage it will need to be replaced.
Washer dryer keeps stopping and starting.	The 'Wrinkle Free' option has been selected	Refer to page 33 for more information.
Not spinning properly	Load has gone out of balance.	Open door and redistribute load, then restart the washer dryer.
	Machine is not level.	Ensure machine is correctly levelled

	Suds build up	Check the amount of detergent used, reduce if necessary
Detergent or fabric softener remaining in detergent dispenser at the end of the cycle	Detergent drawer not properly closed or was opened part way through the cycle.	Ensure the detergent dispenser drawer is fully closed at the start of the cycle and remains closed throughout the cycle.
	Dirty or blocked detergent dispenser.	Clean the detergent dispenser
	Liquid sitting at the 'Max' level at the end of the cycle indicates a blockage	Clean the fabric softener dispenser
	Dispenser over loaded with detergent.	Clean out remaining detergent (refer to pages 27 – 28 for dosing information).
Black or grey marks on clothes	Correct amount of detergent.	Ensure the correct dose of detergent is used for the load size and soil level
	Washer dryer needs to be cleaned.	Empty the machine and complete a 'Drum Clean' cycle
Tangling	Items not sorted correctly	Separate larger items from smaller items.
	Washer dryer loaded incorrectly	Load items loosely and individually into the washer dryer (ie not folded).
	Incorrect cycle for load type selected.	Use the 'Synthetic' cycle to wash shirts
	Washer dryer overloaded in terms of its capacity or the cycle selected.	Try washing average to smaller load sizes.
Washer dryer drains while filling.	Drain hose too low.	Ensure the height of the drain hose is at least 800mm from the floor level
	Drain hose sitting in water.	Clear the drain.

Washer dryer is not draining.	Drain hose blocked.	Clear the drain hose.
	Pump filter blocked.	Clear the pump filter
	Drain hose higher than 1200mm above floor level.	Lower the level of the drain hose
Filling continuously.	Drain hose not connected to standpipe or tub.	Connect drain hose correctly
	Machine siphoning.	Ensure standpipe or tub is at least 800mm from the floor level.
Poor rinsing.	Incorrect detergent used.	Use low sudsing, front loader detergent only
	Too much detergent used.	Ensure the correct dose of detergent is used for the load size and soil level
Cycle time longer than usual/Inaccurate time reading/ Adjustment of time remaining during cycle.	The wash and drying time is approximate.	Wash and drying time may be influenced by a number of factors
	Low water pressure or flow rate.	Ensure that the inlet hose filter is not blocked.
	Out of balance or oversudsing.	Recovery from out of balance or oversudsing will extend cycle time
	Washing a large load	Be aware that it will take longer for the machine to fill.
	Selecting various options	Be aware that some options will extend cycle time.
Dye transfer.	Coloured items not washed separately from white/light coloured items.	Remember to separate whites and colours.
	New or non-colourfast items not washed separately.	Wash non-colourfast items separately and select 'Cold' wash temperature.

	Wet items have been left sitting for too long.	Remove items from washer dryer as soon as the cycle is finished, or if items are not to be removed from the washer dryer immediately, select 'Wrinkle Free'
	Wash temperature.	Consider the wash temperature you select for your coloured items. Lower the temperature if you are concerned.
Too many soap suds.	Incorrect type of detergent used.	Use low sudsing, front loader detergent only
	Too much detergent used.	Ensure the correct dose of detergent is used for the load size and soil level
Poor soil Removal.	Incorrect wash cycle selected.	Select a wash cycle that is appropriate for the amount of dirt
	Insufficient detergent.	Ensure the correct dose of detergent is used for the load size and soil level
	Washer dryer overloaded.	Ensure the washer dryer is not overloaded in terms of its capacity or the cycle selected
	Load was particularly dirty.	Select 'Pre Wash' for particularly dirty loads
	Items not sorted correctly	Wash heavily and lightly soiled garments separately.
	Washer dryer dirty from previous wash or dry cycle.	After washing particularly dirty clothing, we recommend putting the washer dryer through a 'Rinse' cycle after the load has been removed, to wash away any remnants of dirt and to prevent it contaminating future wash or dry cycles
	Incorrect wash temperature selected in relation to the type of soil.	Select a wash temperature suitable for the type of soil, eg warm for greasy soils, cold for muddy soils. Increasing the wash temperature generally improves soil removal and overall wash performance

Washing very wet at the end of the cycle.	Cycle selected not appropriate.	Particularly short or delicate cycles have shorter spins which can result in wetter washing at the end of the cycle.
	Incorrect spin speed for load selected.	Select a faster spin speed.
	An out of balance load has occurred.	The washer dryer compensates for the out of balance by using a lower spin speed, to reduce noise and potential damage to itself.
Dryer does not heat.	Dryer set to 'Air Dry' cycle.	Check what cycle the dryer is set to, change to the preferred cycle
	The dryer has progressed to cool.	The dryer will progress and display 
Dryer is taking too long/ results were not satisfactory.	Drying cycle selected not appropriate for the load.	Select an appropriate cycle for the load
	'Dryness Level' selected not appropriate for the load.	Select a higher dryness level
	Dryer overloaded for the cycle.	Each cycle has a maximum load size Try dividing the load in two and dry half at a time
	Environmental conditions may be affecting dryer operation.	In hot, humid conditions the dryer will take longer to dry a load and be less efficient.
	Dryer not draining water properly	Check the drain hose for blockages or damage. You may need to call for service
	Items got wrapped up inside other items.	Try separating items and drying similar items together. Open items out when you place them in the dryer. Do not fold them up. Untangle items, eg pull long sleeves out so

		they are not stuck/trapped on the inside of the garment
Clothes getting too hot or damaged.	Cycle selected not appropriated for the load.	Ensure the cycle selected is appropriate for items in the load
	Items removed from dryer before the end of cycle cool down had finished.	Removing items before cool down may damage clothing if it is not spread out and exposed to air to cool once removed from the dryer
Cycle time longer than usual.	Cycle time may be affected by a number of factors and is approximate.	Cycle time is affected by the size and composition of the load, how wet/dry the load was to begin with, the environmental conditions the dryer is operating in, cycle options selected, sensing while drying and any interruptions during the cycle
Linting	Washer dryer is overloaded.	Remove some items from the washer dryer, cycles have certain capacity limitations
	Loads not sorted correctly	Dry lint givers separately from lint receivers. Dry similar colours together eg light coloured items with light coloured items, dark items with dark coloured items
	Clothes over dried.	Over drying clothes in the dryer can cause them to attract lint. Use an auto sensing cycle or ensure you check your load if using the 'Time Dry' cycles to avoid over drying
	New items have been dried in the washer dryer recently.	New towels or flannelette sheets can leave lint in the dryer, which may be picked up by subsequent loads
Fabric damage.	Delicate items not dried on an appropriate cycle	Dry delicate items on a 'Delicate' cycle
	Metal parts on the items or in the load.	Fasten zips and other clasps before placing items in the washer dryer
	Items not separated or dried on an appropriate	Dry similar items together. Ensure an appropriate cycle is selected

	cycle for the fabric type.	
	'Dryness Level' selected not appropriate for the fabric type.	Ensure the 'Dryness Level' selected is appropriate for the fabric type. Refer to the items care label
	Instructions on care label not followed.	Follow the instructions on the care label of the items.
Creasing	Washer dryer overloaded.	Do not overload washer dryer.
	Incorrect cycle for load type.	Use specified cycle for particular load type and add on 'Wrinkle Free' option to your cycle.
	Spin speed too fast.	Select a slower spin speed.
	Wet clothes left in washer dryer or laundry basket.	Laundry left sitting wet is more likely to crease. If not removing clothes from washer dryer immediately at end of cycle, select the 'Wrinkle Free' option. Do not leave wet washing sitting in a washing basket.
	Wash temperature too hot for load type	Select a lower wash temperature. Check items care label for correct care
	Items not sorted correctly	Sort load so that items of similar weight are washed and dried together

Warning

This content is compiled from multiple sources and is provided for reference purposes only. It may not be complete or fully applicable to all situations. If you are unable to resolve your issue, please contact the product manufacturer or an authorized service provider for official support.