

PRODUCT DESCRIPTION

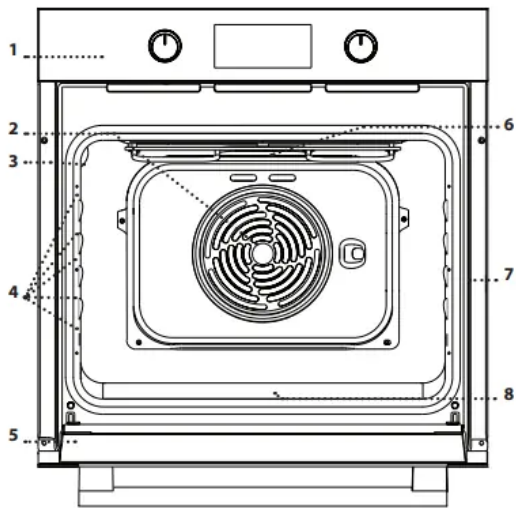

1. Control panel
2. Fan
3. Lamp
4. Accessory guides
(the level is indicated on the wall of the cooking compartment)
5. Door
6. Upper heating element/grill
7. Identification plate
(do not remove)
8. Lower heating element
(not visible)

CONTROL PANEL

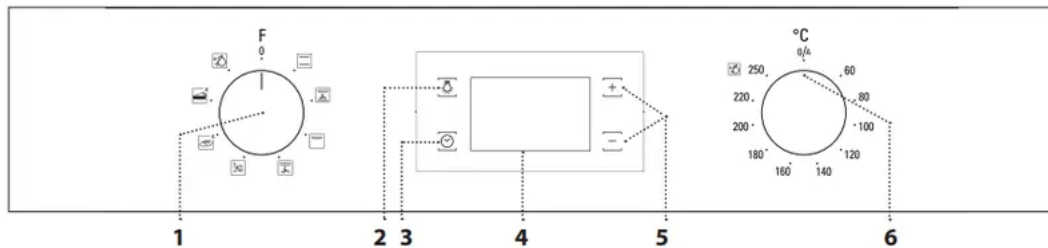

1. SELECTION KNOB For switching the oven on by selecting a function. Turn to the position to switch the oven off.

2. LIGHT With the oven switched on, press to turn the oven compartment lamp on or off.

3. SETTING THE TIME For accessing the cooking time settings, delayed start and timer. For displaying the time when the oven is off.

4. DISPLAY

5. ADJUSTMENT BUTTONS For changing the cooking time settings.

6. THERMOSTAT KNOB Turn to select the temperature you require when activating manual

functions. Automatic functions use 

DESCRIPTION OF DISPLAY

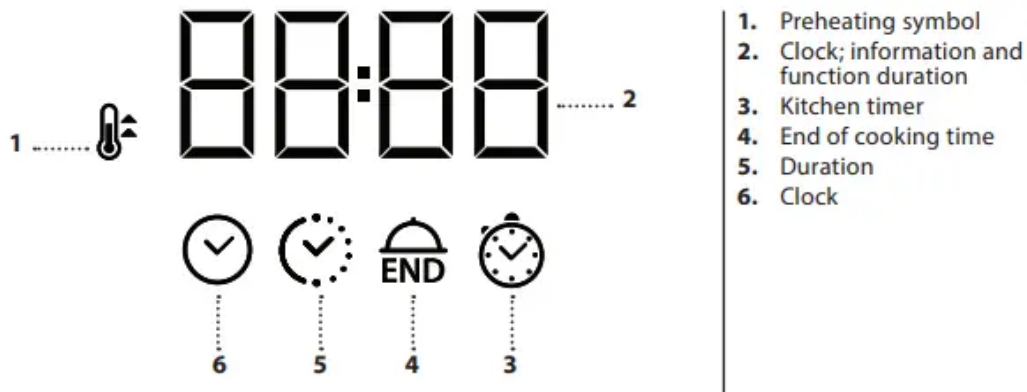

FUNCTIONS



For cooking any kind of dish on one shelf only.



For cooking on a maximum of two shelves at the same time. It is a good idea to swap the position of the baking trays halfway through cooking.



For grilling steaks, kebabs and sausages, cooking vegetables au gratin or toasting bread.

When grilling meat, we recommend using a drip tray to collect the cooking juices: Position the pan on any of the levels below the wire shelf and add 200 ml of drinking water.



For roasting large joints of meat (legs, roast beef, chicken). We recommend using a drip tray to collect the cooking juices: Position the pan on any of the levels below the wire shelf and add 200 ml of drinking water.



For cooking roasts and stuffed roasting joints on a single shelf. Food is prevented from drying out excessively by gentle, intermittent air circulation. When this ECO function is in use, the light will remain switched off during cooking but can be switched on again by pressing .



BREAD AUTO

This function automatically selects the ideal temperature and baking time for bread. For best results, carefully follow the recipe . Activate the function when the oven is cold.



DESSERTS AUTO

This function automatically selects the ideal temperature and baking time for cakes. Activate the function when the oven is cold.





DIAMOND CLEAN







The action of the steam released during this special low-temperature cleaning cycle allows dirt and food residues to be removed with ease. Pour 200 ml of drinking water on the bottom of the oven and only activate the function when the oven is cold.

USING THE APPLIANCE FOR THE FIRST TIME

1. SETTING THE TIME

You will need to set the time when you switch on the appliance for the first time: Press  until the  icon and the two digits for the hour start flashing on the display.



Use  or  to set the hour and press to  confirm. The two digits for the minutes will start flashing. Use  or  to set the minutes and press  to confirm.

Please note: When the  icon is flashing, for example following lengthy power outages, you will need to reset the time.

2. HEATING THE OVEN

A new oven may release odours that have been left behind during manufacturing: This is completely normal. Before starting to cook food, we therefore recommend heating the oven with it empty in order to remove any possible odours.

Remove any protective cardboard or transparent film from the oven and remove any accessories from inside it.

Heat the oven to 250 °C for about one hour, preferably using the “Convection Bake” function. The oven must be empty during this time. Follow the instructions for setting the function correctly.

DAILY USE

1. SELECT A FUNCTION

To select a function, turn the selection knob to the symbol for the function you require: The display will light up and an audible signal will sound.



2. ACTIVATE A FUNCTION

MANUAL



To start the function you have selected, turn the thermostat knob to set the temperature you require.



Please note: During cooking you can change the function by turning the selection knob or adjust the temperature by turning the thermostat knob. The function will only start if the thermostat knob is on 0 °C. You can set the cooking time, cooking end time (only if you set a cooking time) and a timer.

AUTOMATIC



To start the automatic function you have selected (“Bread” or “Cakes”), keep the thermostat knob at the position for automatic functions (0/A). To finish cooking, turn the selection knob to position 0.

3. PREHEATING Once the function starts, an audible signal and a flashing icon  on the display indicate that the preheating phase has been activated. At the end of this phase, an audible signal and the fixed icon  on the display will indicate that the oven has reached the set temperature: At this point, place the food inside and proceed with cooking. Please note: Placing the food in the oven before preheating has finished may have an adverse effect on the final cooking result.



4. PROGRAMMING COOKING

You will need to select a function before you can start programming cooking.

DURATION



Keep pressing  until the  icon and "00:00" start flashing on the display.





Use  or  to set the cooking time you require, then press  to confirm. Activate the function by turning the thermostat knob to the temperature you require: An audible signal will sound and the display will indicate that cooking is complete.

PROGRAMMING THE END COOKING TIME/DELAYED START

After a cooking time has been set, starting the function can be delayed by programming its end

time: Press  until the  icon and the current time start flashing on the display.



Use  or  to set the time you want cooking to end and press  to confirm.

Activate the function by turning the thermostat knob to the temperature you require: The function will remain paused until it starts automatically after the period of time that has been calculated in order for cooking to finish at the time you have set.



Please note: To cancel the setting, switch the oven off by turning the selection knob to position "0".

END OF COOKING

An audible signal will sound and the display will indicate that the function has finished.





Turn the selection knob to select a different function or to position “0” to switch the oven off.



Please note: If the timer is active, the display will show “END” alternately with the remaining time.

5. SETTING THE TIMER

This option does not interrupt or program cooking but allows you to use the display as a timer, either during while a function is active or when the oven is off.

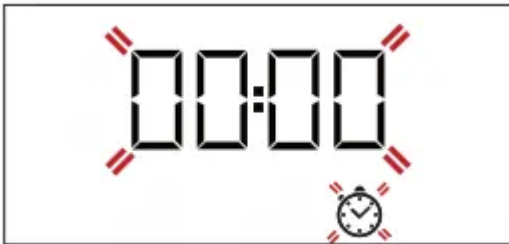
Keep pressing  until the  icon and “00:00” start flashing on the display.



Use  or  to set the time you require and press  to confirm.

An audible signal will sound once the timer has finished counting down the selected time.

6. DIAMOND CLEAN FUNCTION

To activate the “Diamond Clean” cleaning function, pour 200 ml of drinking water into the bottom of the oven, then turn the selection knob and the thermostat knob to the  icon.

Please note: The position of the icon does not correspond to the temperature reached during the cleaning cycle.

The function will activate automatically: The display shows the time remaining to the end, alternating with

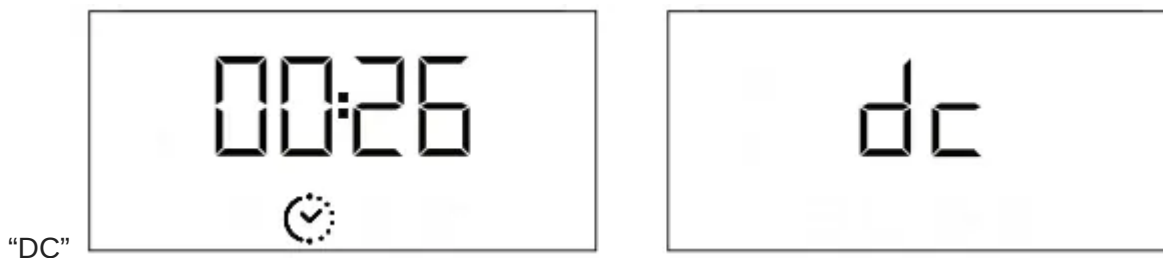

USEFUL TIPS

HOW TO READ THE COOKING TABLE

The table indicates the best function to use for any given food, to be cooked on one or more shelves at the same time . Cooking times start from the moment food is placed in the oven, excluding preheating (where required) . Cooking temperatures and times are purely for guidance and will depend on the amount of food and type of accessory used .Use the lowest recommended settings to begin with and, if the food is not cooked enough, then switch to higher settings . Use the accessories supplied and preferably dark-coloured metal cake tins and baking trays . You can also use Pyrex pans and accessories or ones made from china, but bear in mind that cooking times will be slightly longer .For best results, follow the recommendations in the cooking table carefully when selecting which of the supplied accessories to place on which of the shelves .

COOKING DIFFERENT FOODS AT THE SAME TIME

Using the “Convection Bake” function, you can cook different foods simultaneously (for example: fish and vegetables), using different shelves . Switch shelves two thirds of the way through cooking, if necessary . Remove the food which requires a shorter cooking time and leave the food which requires a longer cooking time in the oven .

DESSERTS

- Cook delicate desserts with the conventional function on one shelf only . Use dark-coloured metal baking pans and always place them on the wire shelf supplied . To cook on more than one shelf, select the “Convection bake” function and position the baking pans on different shelves to facilitate the circulation of hot air .
- Use dark-coloured metal baking pans and always place them on the wire shelf supplied .
- To check whether a leavened cake is cooked, insert a wooden toothpick into the centre of the cake . If the toothpick comes out clean, the cake is ready .

If using non-stick cake tins, do not butter the edges as the cake may not rise evenly around the edges .

- If the item “swells” during baking, use a lower temperature next time and consider reducing the amount of liquid you add or stirring the mixture more gently .

- For desserts with moist fillings or toppings (such as cheesecake or fruit tarts), use the “Convection bake” function . If the base of the cake is soggy, lower the shelf and sprinkle the bottom of the cake with breadcrumbs or biscuit crumbs before adding the filling .

MEAT

- Use any kind of oven tray or pyrex dish suited to the size of the piece of meat being cooked . For roast joints, it is best to add some stock to the bottom of the dish, basting the meat during cooking for added flavour . Please note that steam will be generated during this operation . When the roast is ready, let it rest in the oven for another 10-15 minutes, or wrap it in aluminium foil .
- When grilling pieces of meat, choose cuts of the same thickness to obtain even cooking . Very thick pieces of meat require longer cooking times . To prevent the meat from burning on the outside, lower the position of the wire shelf, keeping the food farther away from the grill . Turn the meat two thirds of the way through cooking . Take care when opening the door as steam will escape .

To collect the cooking juices, we recommend placing a dripping pan filled with 200 ml of drinking water directly underneath the wire shelf on which the food is placed . Refill as necessary .

PIZZA

Lightly grease the trays to ensure the pizza has a crispy base . Scatter the mozzarella over the pizza two thirds of the way through cooking .

BREAD AUTO FUNCTION

Use this function when baking bread: For best results, follow the instructions given in the recipe carefully . Recipe for 1000 g of dough: 60600g of flour, 360 g of water, 11 g of salt, 25 g of fresh yeast (or two packets of yeast powder) .

- Mix the flour and salt together in a large bowl .
- Dilute the yeast in the water (this must be slightly warm – around 35° C) .
- Make a well in the flour and add the water/ yeast mixture, then work into a smooth, slightly sticky dough . Knead the dough with your hands, stretching it out and folding it over for around 10 minutes . Shape the dough into a ball and leave it to rise in a bowl covered with a transparent lid to prevent the surface of the dough from drying out .
- Wait until the dough has doubled in volume: Allow about 90 minutes at room temperature to achieve optimum raising .
- Divide the dough into one or two loaves, sprinkle with flour and make little cuts on the surface . Then place the bread on a baking tray lined with baking parchment .
- Place the dough in the (cold) oven, pour 100 ml of cold drinking water onto the bottom of the oven and activate the “Bread Auto” function . After

Method: cooking, leave the dough to stand on a wire shelf until completely cooled

CLEANING

EXTERIOR SURFACES

- Clean the surfaces with a damp microfibre cloth. If they are very dirty, add a few drops of pH-neutral detergent. Finish off with a dry cloth.
- Do not use corrosive or abrasive detergents. If any of these products inadvertently comes into contact with the surfaces of the appliance, clean immediately with a damp microfibre cloth.

INTERIOR SURFACES

- After every use, leave the oven to cool and then clean it, preferably while it is still warm, to remove any deposits or stains caused by food residues. To dry any condensation that has formed as a result of cooking foods with a high water content, leave the oven to cool completely and then wipe it with a cloth or sponge.
- Activate the “Diamond Clean” function for optimum cleaning of the internal surfaces.
- The door can be easily removed and refitted to facilitate cleaning of the glass. • Clean the glass in the door with a suitable liquid detergent.
- The top heating element of the grill can be lowered to clean the upper panel of the oven.

MAINTENANCE

REMOVING THE DOOR

1. Open the door fully .

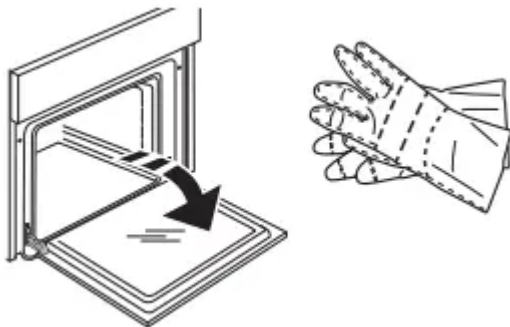

2. Lower the catches as far as possible .

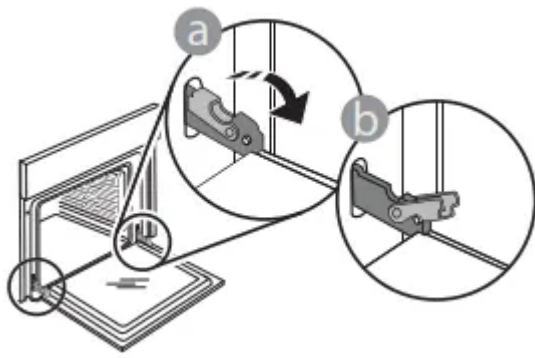

3. Close the door as much as you can .

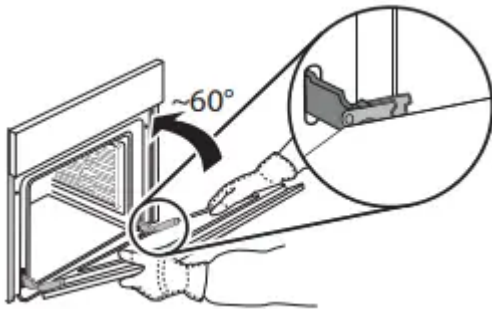

4. Take a firm hold of the door with both hands – do not hold it by the handle . Simply remove the door by continuing to close it while pulling it upwards at the same time until it is released from its seating .

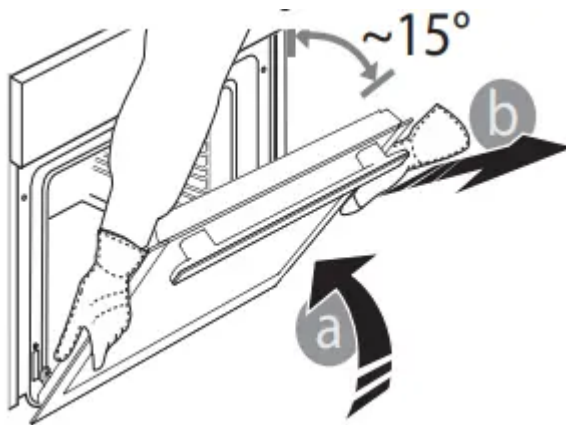

5. Put the door to one side, resting it on a soft surface

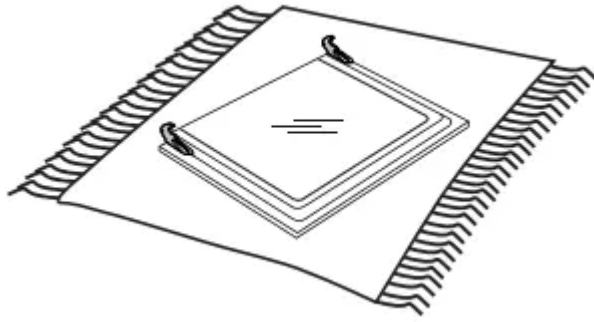

REFITTING THE DOOR

1. Move the door towards the oven, aligning the hooks of the hinges with their seating .

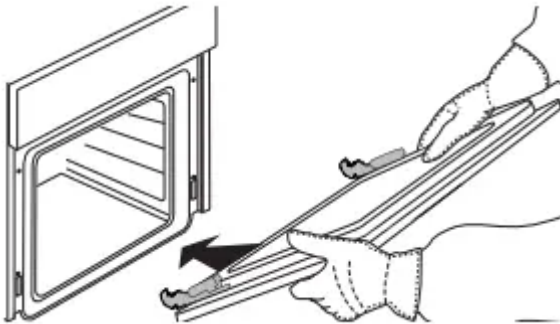

2. Secure the upper part into its seating .

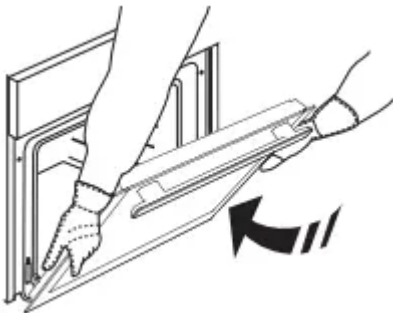

3. Lower the door and then open it fully .

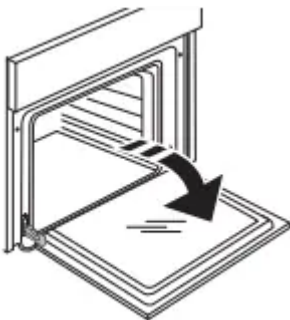

4. Lower the catches into their original position: Make sure that you lower them down completely .

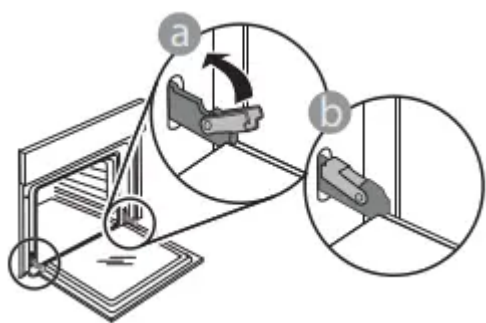

5. Try closing the door and check to make sure that it lines up with the control panel . If it does not, repeat the steps above: The door could become damaged if it does not work properly

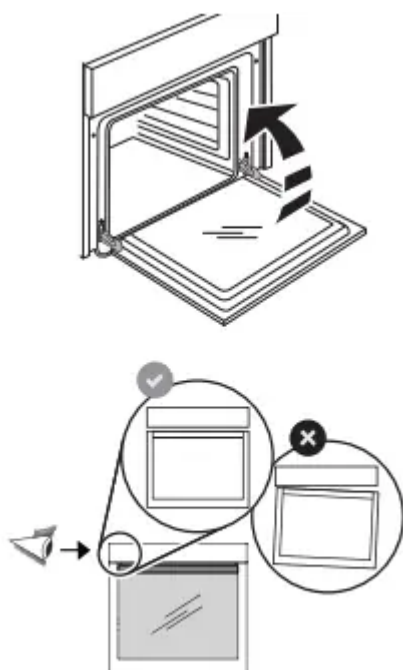

CLICK & CLEAN - CLEANING THE GLASS

1. After removing the door and resting it on a soft surface with the handle downwards, simultaneously press the two retaining clips and remove the upper edge of the door by pulling it towards you .

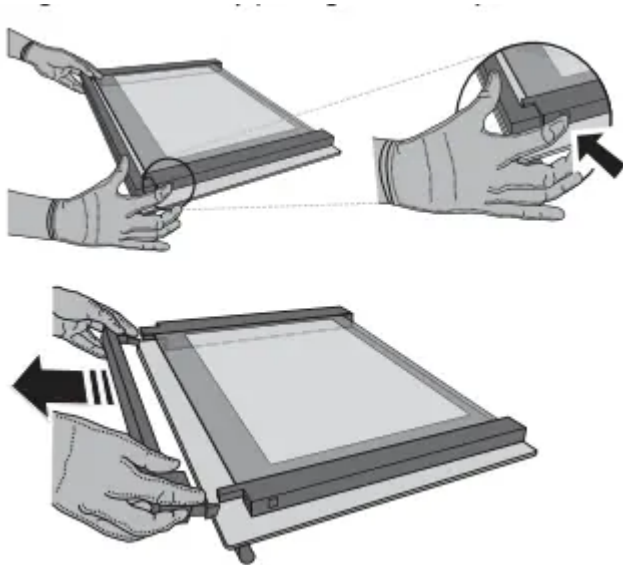

2. Lift and firmly hold the inner glass with both hands, remove it and place it on a soft surface before cleaning it .

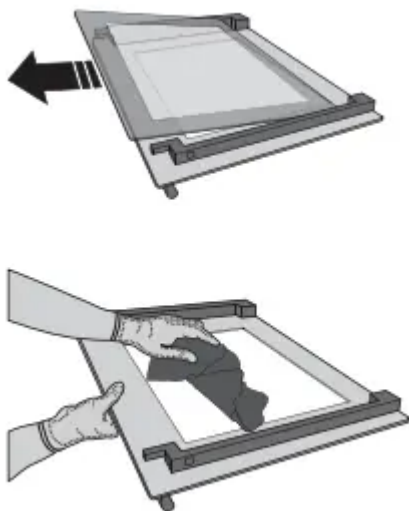

3. To correctly reposition the inner glass, make sure that the “R” is visible in the right-hand corner and the clear surface (not printed) is facing up . First insert the long side of the glass indicated by “R” into the support seats, then lower it into position .

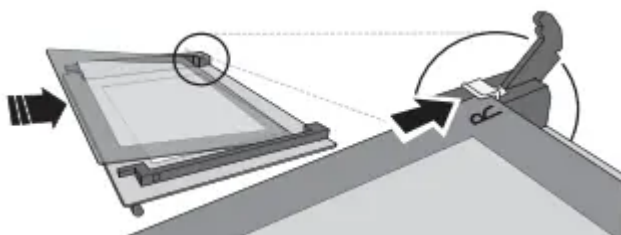

4. Refit the upper edge: A click will indicate correct positioning . Make sure the seal is secure before refitting the door



REPLACING THE LIGHT

1. Disconnect the oven from the power supply .
2. Unscrew the cover from the light, replace the bulb and screw the cover back on the light .

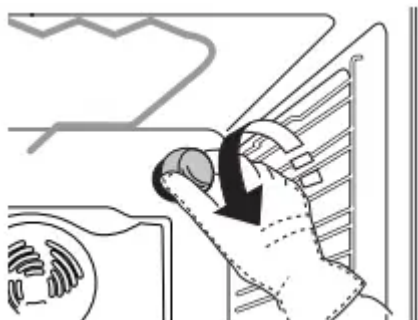

3. Reconnect the oven to the power supply

LOWERING THE UPPER HEATING ELEMENT

1. Remove the heating element from its seating .

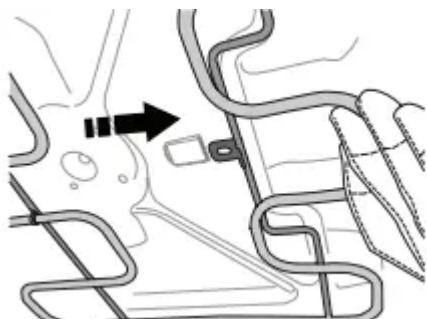

2. Lower the heating element .

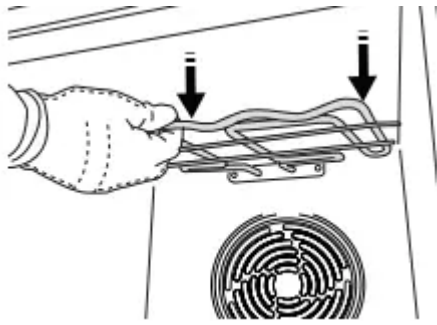

3. To return the heating element to its position, lift it up, pull it slightly towards you and make sure that the tab support is in its proper seating

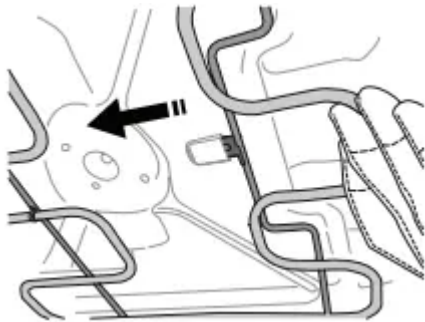

TROUBLESHOOTING

The oven does not work

- Power cut Disconnection from the mains
 - Check for the presence of mains electrical power and whether the oven is connected to the electricity supply. Turn off the oven and restart it to see if the fault persists

The display shows the letter “F” followed by a number

- Software problem
 - Contact you nearest After-sales Service Centre and state the letter or number that follows the letter “F”

Cooking will not start .

- Temperature not set/thermostat knob in the wrong position.
 - Turn the thermostat knob to the temperature or the position you require to activate the function you have selected.

The time is flashing .

- Power cut.
 - You need to reset the time: Follow the instructions given in the “Using the appliance for the first time” section.

The display shows the letter “F” followed by a number .

- Software fault.
 - Contact you nearest Client After-sales Service Centre and state the number following the letter “F”.

The light is not working .

- Oven OFF. Bulb gone.
 - Turn the selection knob to select a function and switch on the oven. If the fault persists, follow the instructions for replacing the bulb given in the “Maintenance” section.

Warning

This content is compiled from multiple sources and is provided for reference purposes only. It may not be complete or fully applicable to all situations. If you are unable to resolve your issue, please contact the product manufacturer or an authorized service provider for official support.