

User manual Remote Control

Setup

Your universal remote requires two (2) AAA batteries (not included). Alkaline batteries are recommended.

Battery Installation

1. On the back of the remote, pull down on the textured surface and slide battery cover downward to remove.
2. Match the (+) and (-) marks on the batteries to the (+) and (-) marks inside the battery compartment, then insert two (2) AAA batteries. Be sure to use fresh batteries.
3. Position battery cover slightly below opening and push upward to lock into place.

NOTE: If your remote stops operating properly, replace the batteries with new ones.

Battery Precautions

- Do not mix old and new batteries.
- Do not mix alkaline, standard (carbon-zinc), or rechargeable (Ni-Cd, Ni-MH, etc.) batteries.
- Always remove old, weak or worn-out batteries promptly and recycle or dispose of them in accordance with local and national regulations.

Battery Saver

- Your remote automatically turns off if the buttons are depressed more than 8 seconds. This will save your batteries should your remote get stuck in a place where the buttons remain depressed (e.g., between the sofa cushions).

Code Saver

- You have up to 10 minutes to change the batteries in your remote without losing the codes you have programmed.

Button Functions

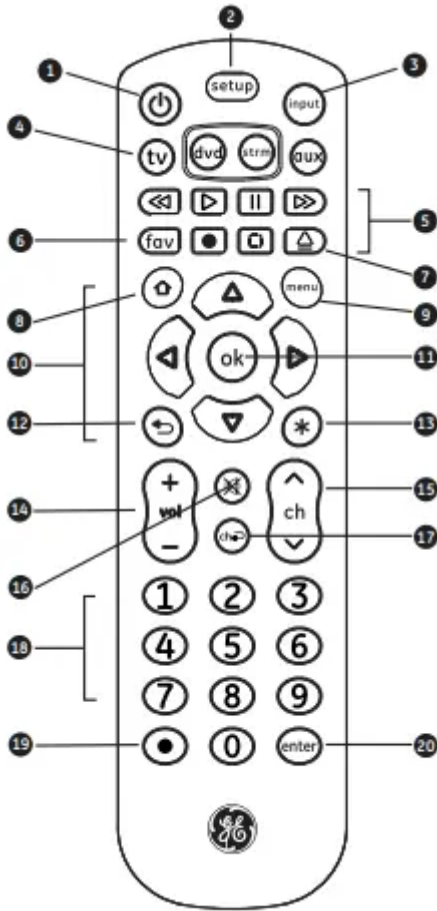

1. Power - Turns devices ON/OFF
2. Setup - Used to program the remote
3. Input - Selects video inputs
4. TV, dvd, strm, aux - Selects the device to control
5. Record, play, stop, rewind, fast forward, pause
6. Programmable Favorites - Program up to 10 favorite channels for quick access
7. Dvd open/close - open/close a player, or List features on cable/satellite receivers
8. Home/Guide - Easily access features on today's streaming devices, or Guide on cable/satellite receivers
9. Menu - Displays the on-screen menu
10. Up/Down/Left/Right menu navigation
11. Ok - Selects menu items for the controlled device
12. Exit - Exit on-screen menus
13. Info - Displays on-screen show/content information
14. Volume Up/Down

15. Channel Up/Down
16. Mute - Mutes sound
17. Previous Channel - Returns to the previously selected channel
18. Numbers - Enter numbers for direct channel selection
19. Dot (•) - Used to select digital channels, e.g., 4.1
20. Enter key (Some devices require enter to be pressed after channel selection)

Programming Your Remote

Your remote is designed to control multiple audio/video devices. To use, you will need to program the remote for your devices. There are two different methods you can use to program the remote, Direct Code Entry or Auto Code Search.

- The Direct Code Entry method is the recommended method as it is the simplest and quickest method in most cases.
- The Auto Code Search method searches through all the codes in the remote to find a code for your device.

Note: This remote comes preprogrammed for Roku® boxes and Samsung TVs. Press TV for Samsung TVs and strm for Roku boxes.

Direct Code Entry (Recommended)

1. Locate the Code List included with your remote. Find the section for the type of device you wish to control, (for example TV, dvd, strm, aux). Locate the brand of your device and circle all the remote codes for the brand.

 2. Press and hold down the SETUP button on the remote until the red light on the remote control turns on. Release the SETUP button. The red light will remain on.

Note: The red light will either be a small light at the top of the remote or the power ON/OFF button.

 3. Press and release the device button on the remote for the type of device you wish to control, (for example TV, dvd, strm, aux). The red light will blink once and remain on.

Note: Any of the device buttons on the remote can be programmed to control any of your devices. For example, you can use the Aux device button on the remote to control a Cable Box, Satellite Receiver, Digital Converter Box, Streaming Media Player or any device category in the Code List.



4. Use the number buttons on the remote to enter the first 4-digit remote code you circled in the Code List in Step 1. The red light will turn off after entering the fourth digit.



5. Point the remote at the device. Test the buttons on the remote to see if the device responds as you would expect. If the buttons do not operate the device, return to Step 2 above and use the next code that you circled for that device.

6. Repeat Steps 1 – 5 for each device you wish to control.

Programming Notes

- Some codes may operate only a few functions of your device. There may be another code in the Code List that controls more functions. Test other codes in the Code List for more functionality.
- If you do not find a remote code that works your device or there are no codes in the Code List for your device, use the Auto Code Search method in the next section to program your remote.
- For combination devices such as a TV/Dvd combo or TV/ VCR combo, you may have to enter a code for each device. (See Controlling Combo Devices, pg. 9.)
- Write down the remote codes used to program the remote for future reference.

Auto Code Search

The Auto Code Search is a process where you can search through all the codes stored in the remote to find a code for your device. It is recommended that you read through all the steps below to familiarize yourself with the Auto Code Search before starting the process.

1. Manually turn on the device you wish to control.

Note: The Auto Code Search process cannot be used for devices without power ON/OFF capability. Use the Direct Code Entry method in these cases.



2. Press and hold down the SETUP button on the remote until the red light on the remote control turns on. Release the SETUP button. The red light will remain on.

Note: The red light will either be a small light at the top of the remote or the power ON/OFF button.



3. Press and release the device button on the remote for the type of device you wish to control, (for example TV, dvd, strm, aux). The red light will blink once and remain on.



4. With the remote pointed at the device, press and release the POWER button on the remote. The remote will send 10 different codes to the device. The red light will blink once for each code and remain on after sending the 10 codes.

Did the device turn off?

- If YES, go to Step 5.
- If NO, repeat Step 4 to test the next 10 codes.

5. Manually turn the device back on.



6. With the remote pointed at the device, press and release the VOL + button. The remote will re-send the first code of the 10 codes from Step 4. The red light will blink once and remain on.

Did the device turn off?

- If YES, you have found a code for the device. Press and release the same device button you pressed in Step 3. This will store the code in the remote. Go to Step 7.
- If NO, continue to press and release the VOL + button until the device turns off to test the other 9 codes from Step 4. Be sure to wait approximately 3 seconds after each VOL + button press to allow the device time to respond to the code. When the device turns off, you have found a code for your device. Press and release the same device button pressed in Step 3. This will store the code in the remote. Go to Step 7.

Notes:

- The VOL – button can be used to go backwards through each batch of 10 codes.
- The red indicator light will flash 2 times after testing the first or last code in each batch of 10.



7. Use the remote to turn the device back on. Test the buttons on the remote to see if the device responds as you would expect. If the buttons do not operate the device, return to Step 2 and repeat this process to search for a better code to operate the device.

8. Repeat this process for each device you wish to control.

Controlling Combo Devices

Some combo devices (e.g. TV/VCR, TV/DVD, DVD/VCR, etc.) will require you to set up two different device buttons to control both parts of the combo device. For example, if you have a TV/DVD combo, you may need to set up one code under the TV button to control the TV and a separate code under the dvd button to control the DVD.

Favorites Function

Allows user to program up to 10 of their favorite channels for quick access.

Setup Favorite Channels

 1. Press and release the device button (TV, dvd, strm, aux). The indicator light will blink once. Note: User must select the device type that controls the channels; for example if a user has a Cable Box for controlling channels, then this device button must be selected to properly change the channels on the cable box.

 2. Press and hold down the SETUP button on the remote until the red light on the remote control turns on. Release the SETUP button. The red light will remain on.

 3. Press and release the FAV button. The red indicator will blink once and remain on.



 4. Press and release the numerical button (0 – 9) that you will use for storing your favorite channel. The red indicator will blink once and remain on.

5. Enter the channel number you wish to program, for example channel 4, 21, 4-1, 52-2.

 6. Press and release the FAV button, the red indicator will turn off. Your favorite channel is now saved.

7. Repeat this process for up to 10 of your favorite channels.

Using Favorite Function

 1. Press and release the FAV button. The red indicator light will turn on.







 2. Press and release the programmed button for your favorite channel (0-9). The red indicator will blink twice and the remote will send the code for your preprogrammed channel.

Using Your Remote





Master Volume Feature

The Master Volume Feature allows you to select a single device that the volume buttons always control. For example, the remote can be in TV mode while the volume buttons control the volume on your audio receiver or sound bar instead of your TV.





Enabling the Master Volume Feature

-  1. Press and hold down the SETUP button on the remote until the red light on the remote control turns on. Release the SETUP button. The red light will remain on.
-  2. Press and release the device button (TV, dvd, strm, aux) on the remote for the device you wish to control the volume.
-  3. Press and release the MUTE button.
-  4. Press and release the VOL+ button. The red light will blink twice and turn off.

Disabling the Master Volume Feature

-  1. Press and hold down the SETUP button on the remote until the red light on the remote control turns on. Release the SETUP button. The red light will remain on.
-  2. Press and release the device button (TV, dvd, strm, aux) programmed to control the Master Volume Feature.
-  3. Press and release the MUTE button.
-  4. Press and release the VOL - button. The red light will blink twice and turn off.

Code Identification

-  1. Press and hold down the SETUP button on the remote until the red light on the remote control turns on. Release the SETUP button. The red light will remain on.
-  2. Press and release the desired device button (TV, dvd, strm, aux) you would like the code for
-  3. Press and release the ENTER button.
- 
 4. Press and release the #1 button. Count the number of times the remote light flashes. This is the number corresponding to the first digit of the code. Repeat the process by pressing the #2, #3 and #4 buttons for the remaining digits.
-  5. Press and release the ENTER button to exit this mode.

Reset to Factory Settings

-  1. Press and hold down the SETUP button on the remote until the red light on the remote control turns on. Release the SETUP button. The red light will remain on.

2. Press and release the MUTE button.
3. Press and release the number #0 button. The red indicator light will flash twice.

Troubleshooting

Remote does not operate your device.

- Make sure the batteries are fresh and installed correctly.
- Aim the remote directly at your device, and make sure that there are no obstructions between the remote and device.
- Make sure you select the appropriate device on the remote you wish to control; TV for TV and CBL for cable box.
- Try programming the remote with a different code. See Direct Code Entry section.
- Remote may not be compatible with your device.

Remote does not operate some features of your device.

- Sometimes a particular code might operate a few features but not all. Try programming the remote with a different code from the Code list. See Direct Code Entry section.
- Remote may not be able to operate all features of your device or button names may be different than that of your original remotes.

Warning

This content is compiled from multiple sources and is provided for reference purposes only. It may not be complete or fully applicable to all situations. If you are unable to resolve your issue, please contact the product manufacturer or an authorized service provider for official support.