

### Moving or storing your appliance

If your refrigerator is turned off for any reason, wait 10 minutes before turning it back on. This will allow the refrigeration system pressures to equalise before restarting.

#### Moving your refrigerator

- Turn off the appliance and unplug from the power point. Remove all food.
- Turn the adjustable feet to the right as far as they will turn (refer to page 18).
- Ease the refrigerator out of its position. Tuck the power cord away, tape the shelves in place and tape the doors closed. If the cabinet needs to be placed at an angle or laid down, carefully lay it on its side (the right hand side when viewed from the front).
- Relocate and install. If the appliance has been left on its side for any length of time, leave it standing upright as long as possible (as least a few hours) before turning it on.

#### Storing your refrigerator

- When storing your cleaned appliance, leave the doors open. This allows air to circulate and prevents the build up of bacteria and moulds.
- Before using again, clean well using a mixture of warm water and a small amount of liquid dishwashing detergent. Rinse with clean water and dry with a soft lint-free cloth.

#### Holiday time

We recommend you leave your refrigerator operating while you are on holiday.

#### Door conversion

ActiveSmart™ refrigerator models with silver handles need to be ordered at the point of purchase either with left or right opening doors and can not be interchanged. All other models need to have an appropriate conversion kit for that model refrigerator. The kit is available from your Fisher & Paykel Authorised Repairer or Dealer. Full instructions are included in the conversion kit.

If you need to hinge your door on the opposite side we recommend that you call your local Fisher & Paykel Authorised Repairer or Dealer to make this conversion.

This does not apply to French door models.

## **Soft closing refrigerator door feature (where fitted)**

The fresh food compartment of your refrigerator has been fitted with a soft closing door feature. You do not need to push the door fully closed as this feature will automatically close the door from a 45° (approximate) opening angle.

### **All soft close models**

You may notice a little more resistance when opening the door(s) to what you are used to. The closing speed of the door(s) decelerates at the end of closing. This is to prevent the door(s) from slamming and to ensure your food items are cared for.

#### **The speed of soft closing can depend on:**

- The load stored in the door shelves.
- The temperature of the fresh food compartment.
- The ambient temperature.

### **French door soft close models only**

The soft closing feature enables you to shut either the left or right door first. You may notice that the closing speed of the left hand door is slightly faster than that of the right hand door. This is perfectly normal. The freezer drawer is fitted with an additional mechanism to soft close within the last 50 mm.

#### **Important!**

- Keep hands and food items clear of the door opening when the gap less than 45° (the soft close activation range).
- The soft closing feature is located inside the door cavity therefore it is not serviceable by the user. If a problem occurs, please contact your Fisher & Paykel Authorised Repairer.

## **ActiveSmart™ operating instructions**

#### **Models:**

- 635 mm wide
- E372B, E402B
- 680 mm wide
- E406B, E442B
- 790 mm wide
- E522B, RF522A,
- RF522W
- 900 mm wide

- RF610/RF540A

The control panel enables you to view and modify all the features and options on your refrigerator.

### Temperature control (all models)

- When the refrigerator is first turned on, the powerful cooling system will automatically cool both refrigerator and freezer compartments to their set temperatures. This will take between 2 – 3 hours.
- The two compartment temperatures are accurately and independently controlled and do not change with the temperature or humidity of the surroundings; whether summer or winter.
- If you wish to alter the temperature of either the fresh food compartment or freezer compartment, this can be easily done by using the internal control panel located at the front right of the refrigerator compartment.

### Internal control panel to adjust temperatures



Fig.16 Internal control panel for Tasman models





Fig.17 Internal control panel for Designer and Elegance models





Fig.18 Internal control panel for Ice & Water models

### Fresh food compartment (all models)

- The fresh food compartment light will automatically be illuminated. The temperature for this compartment will show as a series of lights.

- The temperature may be altered by pressing the  or  buttons. One press on either of these buttons will reduce or increase the number of lights by one which indicates a small change in temperature.
- Fewer lights illuminated means a cooler temperature for the compartment selected.

### Freezer food compartment (all models)

- To adjust the freezer temperature press the  button once so the freezer compartment light is illuminated.
- The freezer temperature can be altered by pressing the  or  buttons.
- One press on either of these buttons will reduce or increase the number of lights illuminated which indicates a small change in temperature.
- Fewer lights illuminated means a cooler temperature for the compartment selected.



Note: successively pressing the  button will automatically scroll between the compartments.

- When the door is re-opened the control panel will return automatically to the fresh food compartment setting.



### Alarm Mute (all models)

For times when you require the door to be open longer than normal eg when cleaning the interior of your refrigerator press the ALARM MUTE button to silence the door alarm for 20 minutes.

- To activate, press the  button once. The ALARM MUTE light will be illuminated when the function is activated.
- ALARM MUTE will deactivate after 20 minutes and the door alarms will return to normal.
- To deactivate ALARM MUTE manually, press the  button again. When ALARM MUTE is deactivated the light is off.

**Note:** when the fresh food or freezer compartment door is left open for long periods of time food quality and / or safety may be compromised.

### Door alarms (all models)

- If the fresh food compartment door is left open the alarm will beep after 90 seconds and if the freezer door is left open the alarm will beep after 60 seconds.





- While either door remains open, subsequent beeps will sound every 30 seconds for 5 minutes.
- A continuous alarm will sound if either of the doors have been left open for 5 minutes or longer and the interior compartment light(s) will turn off. The alarm will stop only when the door(s) is closed.

**Note:** if ALARM MUTE has been activated the door alarms will be silenced for 20 minutes. After 5 minutes of the doors being left open the compartment light will turn off however the normal door alarms will be suspended. The ALARM MUTE light will be illuminated to indicate that the appliance is in this mode.



### Key Mute (all models)



KEY MUTE allows you to silence all button presses.

- To activate KEY MUTE and silence buttons, press and hold the  button for 4 seconds.
- The  icon on the internal control panel will be illuminated.
- The keys will be silenced when KEY MUTE is activated.
- Door alarms and BOTTLE CHILL alarm will still operate.
- KEY MUTE will not automatically deactivate. To manually deactivate, press and hold the  button for 4 seconds.
- The  icon will no longer be illuminated



### Key Lock (all models)

KEY LOCK allows you to disable the buttons on the internal control panel. This is useful when cleaning your refrigerator.

- To activate KEY LOCK press and hold the  and  buttons for 4 seconds.
- The  icon on the internal control panel will be illuminated.
- Pressing any of the buttons will cause a raspberry beep to tell you that they are disabled.

- KEY LOCK will not automatically deactivate. To manually deactivate, press and hold the



 and  buttons for 4 seconds.

- The  icon will no longer be illuminated.







### Sabbath mode activation (all models)

- To activate SABBATH MODE, open the door(s) of the fresh food compartment and

freezer compartment and then press and hold the   and  buttons on the internal control panel for 4 seconds.

- The candle icon will illuminate when SABBATH MODE has been activated.

#### When the product is in Sabbath mode:







- The  icon on the internal control panel will be illuminated.
- All lights on the internal control panel except for the candle icon will be off.
- The fresh food or freezer compartment lights will not operate when the door(s) is opened.
- The door alarms will not operate.
- The internal control panel will not function except to indicate SABBATH MODE is active as stated above.
- Opening the door(s) will not affect the compressor or fans.
- If the power to the refrigerator is turned off whilst in this mode, the product will continue in SABBATH MODE when the power is restored.
- SABBATH MODE will automatically de-activate 80 hours after activation.
- To de-activate earlier than 80 hours press and hold the   and  buttons for 4 seconds. The candle icon will no longer illuminate on the internal control panel and functionality of the internal control panel will return to normal.

### Special Functions



#### Bottle Chill (Elegance, Designer and Ice & Water models only)



This function allows you to chill your beverages more rapidly in the freezer without the worry of forgetting about them. The timer is set for 15 minutes however the time taken to chill depends on the size of your beverage. If after 15 minutes your beverage is not cold enough, simply place it back in the freezer and reset the BOTTLE CHILL function.

- To activate, press the  button on the internal control panel. The BOTTLE CHILL light will be illuminated when the function is activated. The  icon will be illuminated on the external display (Ice & Water models only).
- An alarm will sound after the 15 minute time has elapsed.
  - For non Ice & Water models: open the fresh food compartment door and press the  button on the internal control panel to silence the alarm.
  - For Ice & Water models: the  icon will flash on the external display. Press the  **Lock** button on the external display to silence the alarm.
- Remember to remove your beverage from the freezer.
- To deactivate BOTTLE CHILL before 15 minutes has elapsed, press the  button again. When the function is deactivated the BOTTLE CHILL light is off on the internal control panel and the  icon is not visible on the external display (Ice & Water models only).



### **Fast Freeze (Elegance, Designer and Ice & Water models only)**

We have created the FAST FREEZE feature to help you get the best possible results when freezing fresh food. FAST FREEZE boosts the freezing speed by dropping the freezer to its coldest temperature for 12 hours, which helps to ensure vital freshness, texture and taste are retained during the freezing process.

- To activate, press the  button on the internal control panel. The FAST FREEZE light will be illuminated when the function is activated.
- To deactivate before the 12 hours has elapsed, press the  button again. When FAST FREEZE is deactivated the light is off.

- For best results we recommend that you activate the function before it is required. Alternatively, activate it when placing food into the freezer.

## All about the external display (Ice & Water models only)

This screen enables you to lock the water dispenser, indicates to you when BOTTLE CHILL is activated and when your water filter requires changing.

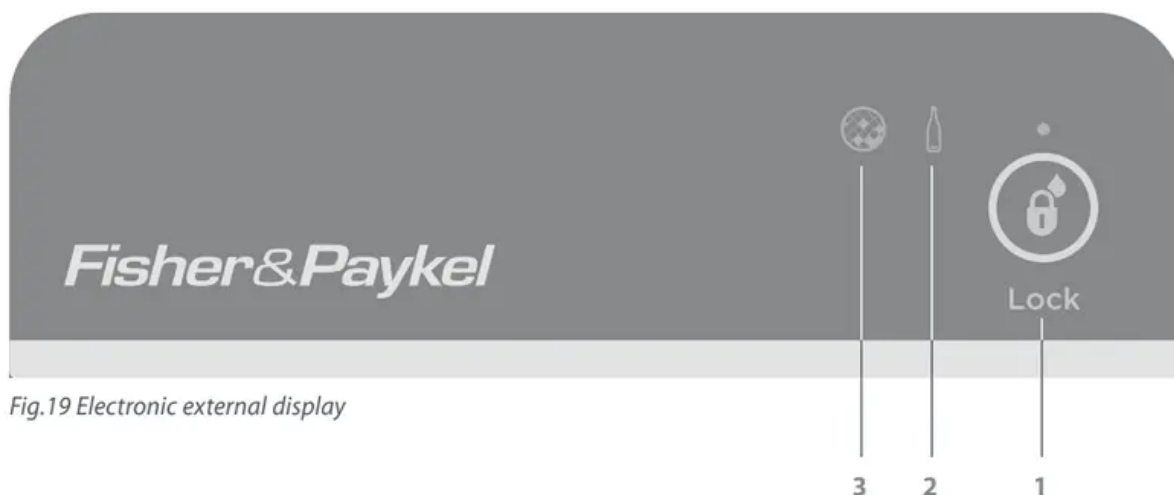





Fig.19 Electronic external display

### Keys

 Lock	<b>1. Dispenser lock button and light</b> Locks/unlocks the water dispenser. Light is on when the water dispenser is locked.
	<b>2. Bottle Chill indicator</b> Indicates when BOTTLE CHILL is on and flashes when beverage is ready.
	<b>3. Filter change indicator</b> Indicates when the water filter requires changing.

**Note:** icons will be visible only when the functions are active.

Using your water dispenser (Ice & Water models only)

### Dispensing

- Your water dispenser has been designed for one-handed operation.
- To dispense water push the dispensing pad gently, using a glass or container. This pad requires only a gentle press to activate.
- To stop the flow of water, simply pull your glass away from the dispensing pad.



*Fig.20 Water dispenser*

Please remember that pressing very hard against the dispensing pad will not encourage the dispenser to operate faster or produce greater quantities of water.

#### **First use**

Please make sure you have read and followed page 17 before using your water dispenser.

**Important!** To avoid damage to property or personal injury do not put hands, fingers or objects up the dispenser opening

Please note that once installation is complete a few drips may appear out of the dispenser over the next few days as the remaining trapped air is cleared.



#### **Dispenser Lock**

The DISPENSER LOCK prevents water from being dispensed. This is useful when you are cleaning the external display or when there are small children around.

- Press and hold the  button for 4 seconds to activate DISPENSER LOCK.
- The light above the DISPENSER LOCK icon will be illuminated.
- Pressing the water dispenser pad will cause a raspberry sound indicating to the user that water cannot be dispensed.

- To de-activate the DISPENSER LOCK, press and hold the  button for 4 seconds. The light above the DISPENSER LOCK icon will no longer be illuminated and water dispensing will be enabled.



*Fig.21 Dispenser Lock*

### **Water filter (Ice & Water models only)**

All the water to your refrigerator is filtered to remove impurities through a filter cartridge located in a position of your choice outside the refrigerator. This will need changing approximately every 6 months.

- There is a replacement indicator  icon on the internal control panel and external display which will appear when the filter needs replacing. It will flash, as a reminder, when water is dispensed.
- Replacement filter cartridges are available through Customer Care or online at [www.fisherpaykel.com](http://www.fisherpaykel.com) (this service is available to selected markets only). The details of the replacement filter cartridge are on the label of the cartridge. Alternatively filter cartridges can be purchased from your Fisher & Paykel Authorised Repairer.

## Changing the water filter cartridge

It is not necessary to turn off the water supply before attempting to change the water filter cartridge.

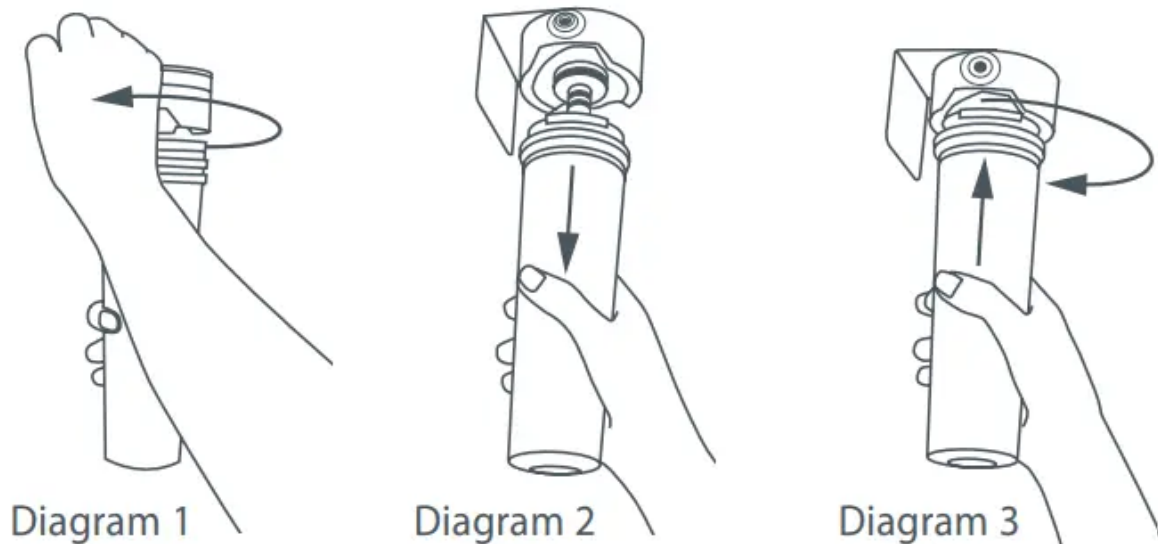

1. Grasp and firmly twist the cartridge in an anticlockwise direction (to the left when installed in the recommended orientation) as shown in Diagram 1.
2. Pull the cartridge away from the filter head (down when installed in the recommended orientation) as shown in Diagram 1 of Fig 22 below.
  - It is not unusual for a few drops of water to be present when the filter is removed.
3. Discard the old filter.
4. Filter installation:
  - Remove protective cap on spigot on head.
  - Push the cartridge up towards filter head while rotating it in a clockwise direction (to the right when installed in the recommended orientation) as shown in Diagram 3.
5. Reset filter indicator icon on the display (this will remind you when the filter is due to be replaced again). Refer to page 30.
6. To flush the water filter of any trapped air, harmless carbon fines and to also check for leaks, disconnect the tubing from the back of the refrigerator, aim the end of the tubing into a bucket, turn isolating tap on and run at least 10 litres (10 qt) of water through. Once complete turn isolating tap off. Reconnect the tubing.
7. A few drips may appear out of the dispenser over the next few days as the remaining trapped air is cleared.



*Fig.22 Changing the water filter cartridge*



#### To reset the filter indicator

**Important!** We recommend the water filter to be used from the time of installation. Do not reset indicator before filter is changed or filter monitoring will be inaccurate.

- Press and hold  and  for 4 seconds to reset the internal and external filter indicators.
- The  icon on the internal and external displays will turn off when reset.

#### To disable the filter indicator

**Note:** if disabled, you will not be reminded to next change your filter.

- When no filter is fitted, you can disable the filter indicator.
- Press and hold   and  for 4 seconds to turn this feature off.
- We recommend that you do not disable the filter indicator if you have a filter fitted to the connection.

#### Important!

- To avoid serious illness or death, do not use the water filter where water is unsafe or of unknown quality.
- The water filter cartridge needs to be changed when the filter indicator icon flashes on the interface panel.

- We recommend the water filter cartridge is replaced when the internal and external



icons illuminate. This will happen every 6 months.

- If the water filtration system has been allowed to freeze, replace filter cartridge.
- The rate of water flow through the water dispenser can slow down as the filter cartridge accumulates any sediment which may be present in the water supplied to your home. This varies depending upon your local water quality, which may require your filter cartridge to be changed more frequently.
- In cases of excessively reduced filter life we recommend that you consult a local plumber or your water supplier for advice on suitable filtration requirements for the water supplied to your home.
- Filter replacement is the consumer's responsibility and will not be covered by the warranty except in the case of faulty parts or materials within the filter cartridge.
- If the water has not been dispensed for some time or water has an unpleasant taste or odour, flush system by dispensing 3 litres (3 qt) of water.
- If unpleasant taste or odour persists, you may wish to fit a new filter cartridge.

## Using your ice maker (Ice & Water models only)



### Ice On/Off

Your ice maker is designed to automatically dispense ice until it senses that the bin is full. So the more ice you use, the more it makes. It is even clever enough to sense when there is no bin in place to catch the ice and it will not dispense any ice.

## First use

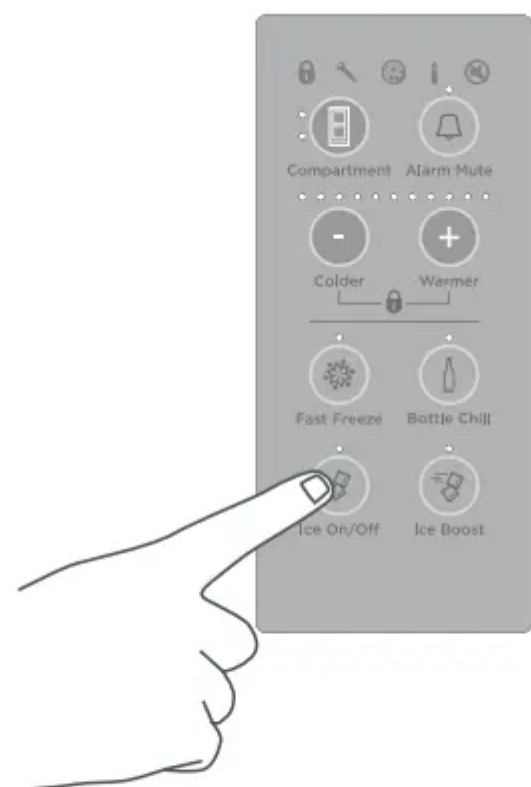



*Fig.23 Turning ice maker on*

- When you first turn your refrigerator on after installation, the ice maker will be off. The light above the ICE ON/OFF icon will be off.

•

To turn your ice maker on press the  button. The light above the ICE ON/OFF icon will be illuminated when the ice maker is on.

•

Press and hold ,  and  together for 4 seconds then close the door(s). The ice tray will flip. Force another cycle. The ice tray will flip and spill the water into the ice bin. Empty water and replace bin. Note: the ice tray will flip only once doors are closed.

- If the bin is full of ice, inserted incorrectly or if all bins are removed, the ice maker will not operate. When the bin is inserted correctly the scoop will be on the right hand side of the bin for models E402B, E442B, E522B, RF522W and RF522A and at the front of the bin for models RF610A and RF540A (refer to Fig.24).
- Once your ice maker is in operation, discard the first 3 harvests of ice (8 ice cubes are produced per harvest). This will flush away any impurities in the water line and ensure

that you get the best quality ice. We recommend that you also do this after vacations or extended periods of not using ice.

- We recommend that you turn the ice maker off if:
  - The water supply is to be off for several hours, or
  - The ice storage bin is to be removed for a period of time, or
  - You are going on holiday/vacation.



E402B, E442B, E522B  
RF522A and RF522W

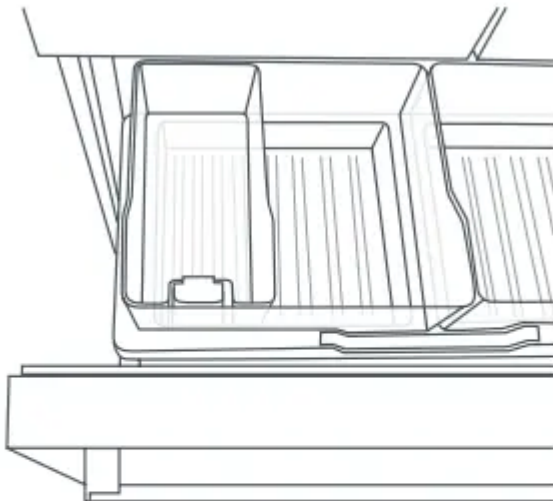

RF610A/RF540A

*Fig.24 Ice storage bin and  
scoop in correct position*

## Information about your ice maker

- Your automatic ice maker will produce approximately eight cubes of ice every 3 – 4 hours, depending on the freezer compartment temperature and the number of door openings.
- When the ICE BOOST function is activated, ice production will increase up to 30% from standard ice making.
- The ice cube tray will fill with water.
- When cubes are frozen, they will be ejected from the ice tray into the ice storage bin.
- Ice making will continue until the storage bin is full.
- Ice making will resume once you start to use the stored ice.
- Your Ice & Water product comes with a smaller ice bin inside the larger freezer bin. Attached to the ice storage bin is the hygienic scoop for the ice. This scoop provides hygienic access to the ice.
- If a large amount of ice is required, remove an ice storage bin and allow ice to fall into the larger bin.
- For maximum ice storage, level the stored cubes with the ice scoop.
- If ice is not used often, old cubes will become cloudy, taste stale, will shrink and may stick together. Empty the ice storage bin periodically and wash in lukewarm water. Dry thoroughly and place back into the correct position.





### Ice boost function

This function is designed to be used for times when you require more ice eg when you are having a party. The ICE BOOST function will increase ice production up to 30% from standard ice making and deactivate automatically after 24 hours.

- When you first turn your ice maker on, the ICE BOOST function will be off.

•

To turn this function on, press the  button. The light above the  button will be illuminated when the ICE BOOST function is on.

- The ICE BOOST function is paused once your ice bin is full.

•

To manually deactivate this feature press the  button again. The light above the



button will be off when the ICE BOOST function is off.

- Activating the ICE BOOST function will automatically turn ice making on.

- Deactivating ice making will automatically deactivate the ICE BOOST function.

### **Important!**

- Avoid contact with the moving parts of the ice maker ejector mechanism, and do not place your fingers on the automatic ice making mechanism while the refrigerator is in operation.
- Do not use ice cubes that may have become discoloured, usually with a green-blue colour. If such discolouration is noted, discard the ice cubes and contact your Fisher & Paykel Authorised Repairer.
- Ensure the ice maker is connected to the filter and to a drinkable water supply only.
- Installation of the water connection to the ice maker must be completed by a qualified service technician or a qualified plumber (see installation instructions).

For manual ice making please refer to page 35.

## **ActiveSmart™ special features (all models)**

### **Fruit and vegetable bins and humidity control lid**

The fruit and vegetable bins feature a unique lid which provides two functions:

- The humidity lid seals the bins and provides a humid microclimate to extend storage times of fruit and vegetables.
- The humidity lid prevents condensation, which forms at high humidities, from dripping down onto the fruit and vegetables by retaining it in the grooves of the lid.

### **Fruit and vegetable bins and humidity slide**

- Each fruit and vegetable bin has a humidity slide control that can be adjusted to a fruit or vegetable setting depending on what is stored in the bins.
- If possible try to store fruit and vegetables separately. This will help extend their storage life.
- If there is a mixture of fruit and vegetables in the bin adjust the position of the control to the centre.
- If there is too much water in the bins (due to the high humidity in the bins), the control can be adjusted towards the setting with fewer drips (fruit setting) and/or the water can be wiped out as required.
- Remember a minimum amount of water in the bins is beneficial for fruit and vegetable storage.

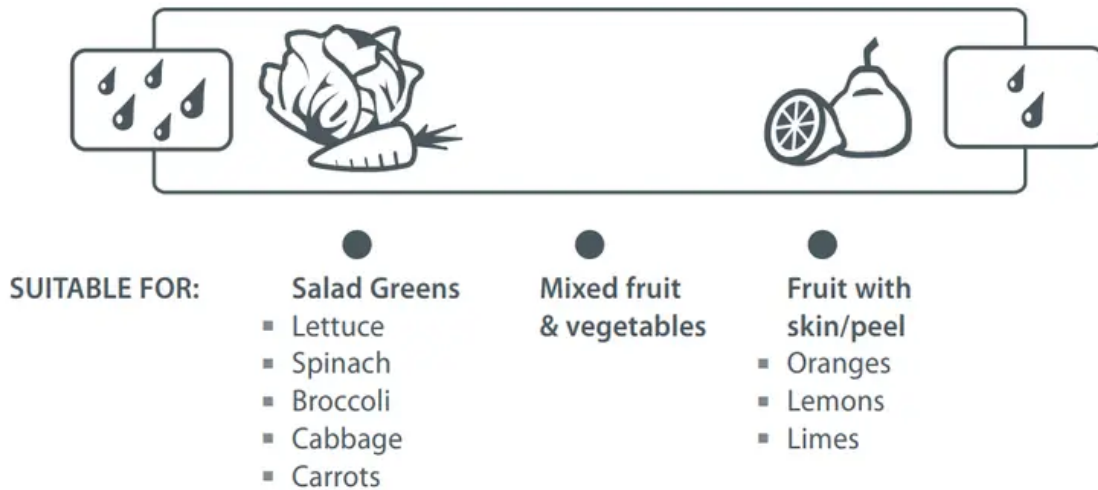

*Fig.25 Humidity control graphic*

### **Slim storage drawer (where fitted)**

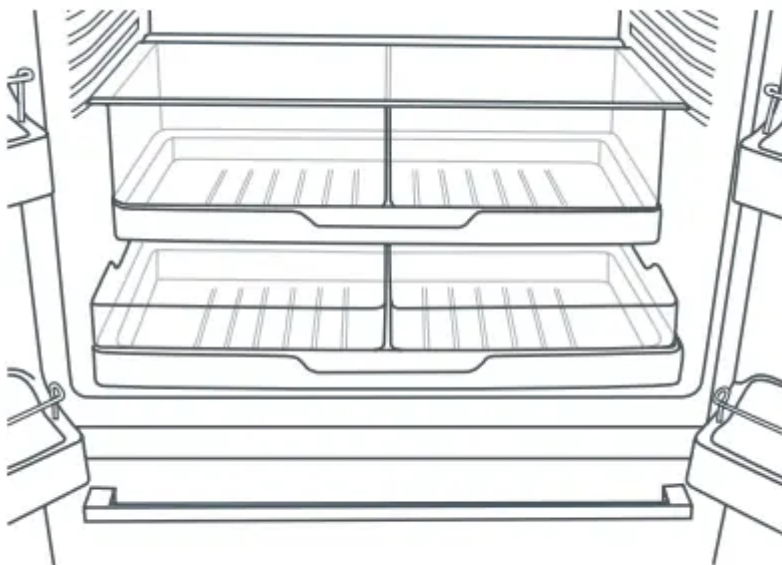

*Fig.26 Slim storage drawer*

The slim bins at the bottom of the fresh food compartment provide storage space for items that you may want to keep separate from the rest of the refrigerator. These slim storage bins can be used for deli item storage, beverages or for defrosting foods.

### **Bottle holder (where fitted)**

- The bottle holders can be used to store a variety of bottles.
- To position the bottle holder in your refrigerator, simply slot the back edge of the bottle holder onto the back trim of any shelf in the fresh food compartment.

- If you are not using all or some of the bottle holders, the unused bottle holders can be stacked up on top of one another so they do not take up unnecessary shelf space.
- Bottles are best stored with the neck of the beverage facing the front of the refrigerator.
- Additional bottle holders are available through Customer Care or online at [www.fisherpaykel.com](http://www.fisherpaykel.com) (this service is available to selected markets only).

### **Glass shelves**

- Glass shelves can be repositioned in the cabinet as desired.
- Remove shelves by lifting up the back of the shelf and then pulling the shelf forward.

### **Drip tray (Ice & Water models only)**

- The drip tray is designed to fit into the bottom of the water dispenser panel.
- To insert the tray always ensure that the rounded sides are fitted into the dispenser panel first.
- The purpose of the tray is to capture any odd drips of water that may fall after dispensing.
- The tray can be easily removed for cleaning (see page 36).

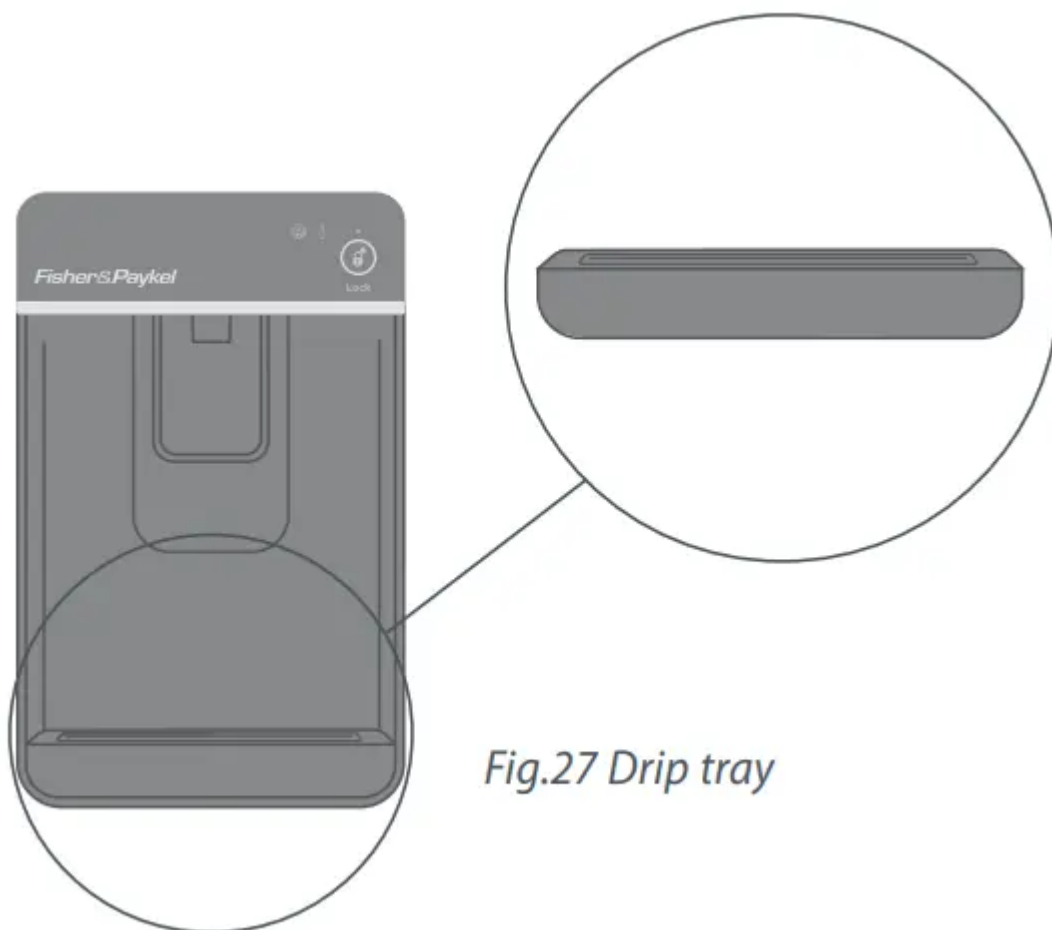

*Fig.27 Drip tray*

## Manual ice system – RF522W and RF522A (non Ice & Water models only)

An ice storage bin which sits inside the upper top freezer bin provides storage for and gives you access to clean, clear ice cubes.

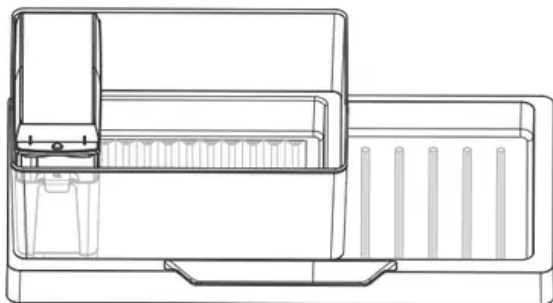

*Fig.28 Upper left freezer bin, ice storage bin, ice tray, lid and scoop in correct position*

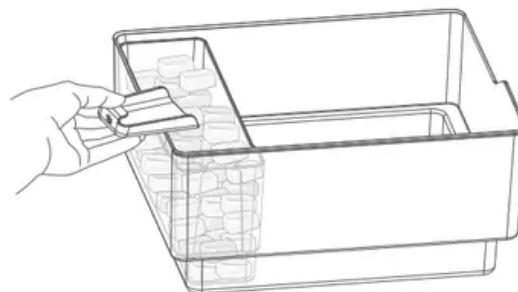

*Fig.29 Accessing your ice*

### Information about your manual ice system

- To make ice, take the ice tray and lid from on top of the ice storage bin. Remove the lid from the ice tray and fill the tray with water. Place the lid back on the ice tray and carefully position it back onto the ice storage bin.
- Once the ice is solid, take the ice tray and lid off the ice storage bin, remove the lid from the tray and twist the ice tray at each end in opposite directions. Turn the ice tray over the ice storage bin to dislodge the cubes into the bin.
- Fill the ice tray with clean water and repeat to fill the ice storage bin.
- Attached to the ice storage bin is the ice scoop which provides hygienic access to ice.
- To access ice cubes, take the ice tray and lid from the top of the ice storage bin and place onto a flat surface. Take the scoop from the front of the bin, scoop cubes into vessel and then replace the scoop, tray and lid back to the top of the bin.
- For maximum ice storage, level the stored cubes around the bin with the ice scoop.
- If ice is not used often, old cubes will become cloudy, taste stale, will shrink and may stick together. Empty the ice storage bin periodically and wash in lukewarm water. Dry thoroughly and place back in the correct position.

### Ice trays and lid (all other non Ice & Water models)

- To make ice, remove the lid from the ice tray and fill the tray with water. Place the lid back on the ice tray and carefully position it on a flat surface in the freezer compartment.
- To empty the ice cubes into the lid, hold the tray and lid together and twist the ends of the tray in opposite directions to dislodge.
- Refill the ice tray with water and store in the freezer.

- Ice cubes are best stored in a closed container or plastic bag as they readily absorb odours and tastes from other foods.

## **Cleaning and caring for your refrigerator**

### **Exterior (all models)**

#### **Stainless exterior doors**

- It is important when cleaning the exterior door surface of your refrigerator, to only use liquid dishwashing detergent dissolved in warm water and a soft cloth.
- Dry the door with a clean, lint free cloth.
- The use of any abrasive or stainless steel cleaners and solvents will damage the door surface.

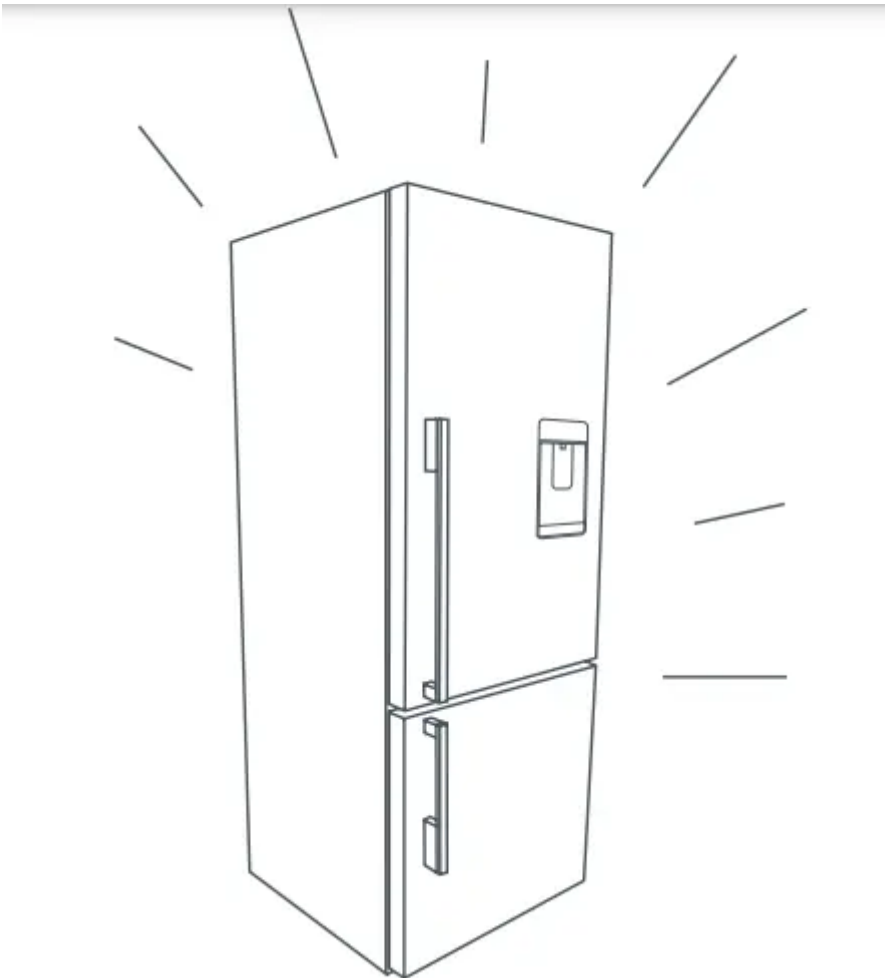

#### **Other exterior surfaces (all models)**

- Clean all other exterior surfaces with a mix of warm water and liquid dishwashing detergent, and a soft cloth.

- If necessary, clean the magnetic door gasket and the centre door gaskets with an old toothbrush, warm water and liquid dishwashing detergent.

### **Water evaporator tray (all models)**

- The water evaporator tray is found above the compressor at the back of the refrigerator. The tray may require infrequent cleaning.
- Carefully move the refrigerator out from the wall.
- Switch off the appliance.
- We do not recommend that you remove the evaporator tray. If cleaning is required, excess water can be soaked up from the evaporator tray using a sponge. Wipe out with warm water and liquid dishwashing detergent or disinfectant.
- Switch on and replace the appliance.

### **Water dispenser pad and interface (Ice & Water models only)**

- We have incorporated a Dispenser and KEY LOCK function in your refrigerator to make cleaning easier (refer to page 28). This will help you to avoid accidental water dispensing while you clean.
- Clean the pad and interface panel with a microfibre cloth and a mixture of warm water and liquid dishwashing detergent

### Drip tray (Ice & Water models only)

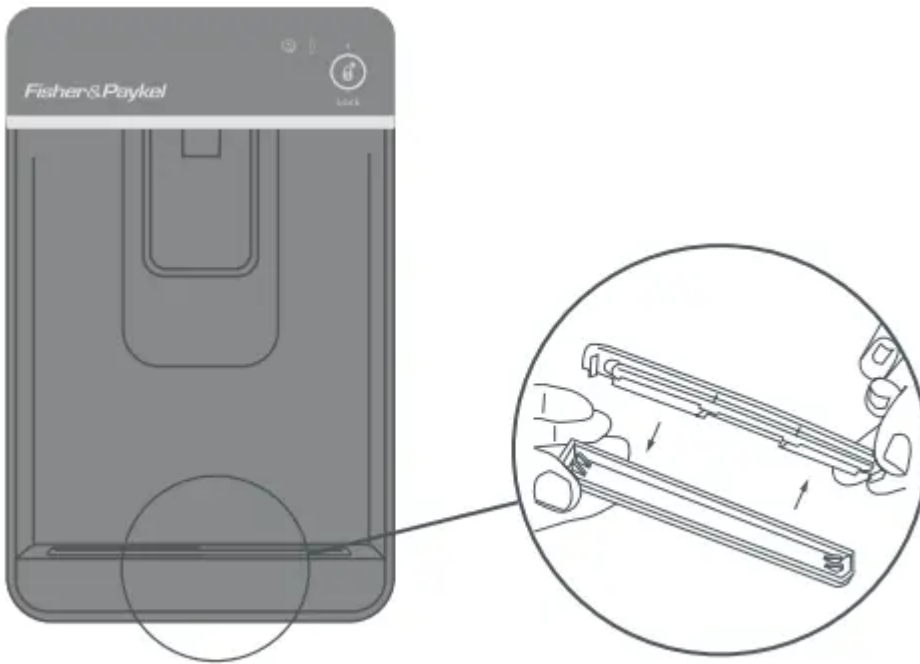

*Fig.30 Cleaning the drip tray*

- To clean, take the tray out of the dispenser panel and pull the two halves of the tray apart.
- Clean in warm water with a mild detergent. Dry the tray and clip back together.
- Reinsert the tray back into the dispenser panel.

### Interior (all models)

- It is important to keep the interior of the refrigerator and freezer clean to help prevent food from becoming contaminated during storage.
- The amount and types of food stored determines how often cleaning should be carried out in the refrigerator (ideally once every 1 to 2 weeks).
- Remove the shelves from cabinet and door. Wash shelves and storage bins in warm water and detergent; rinse in clean water and dry before replacing.
- Wipe over the interior surfaces with warm water and liquid dishwashing detergent. Alternatively you can use 1 tsp baking soda dissolved in 500 ml (1/2 qt) of warm water. Rinse with clean water.
- To help remove “old stale refrigerator” smells add a few drops of vanilla essence or vinegar to the water before cleaning.
- Clean interior surfaces with warm water and liquid dishwashing detergent. Use a toothbrush for the magnetic door gasket.

- Do not use harsh, abrasive cloths on any part of the refrigerator or freezer.

### **Glass shelves (all models)**

- Clean with warm water and detergent or a glass cleaner.

### **Bottle holder (where fitted)**

- Clean with warm water and detergent. The use of abrasive cleaners and solvents may cause damage.

### **Automatic ice dispenser (Ice & Water models only)**

- We do not recommend you clean the ice maker componentry, but it is important to clean the bins occasionally.
- The storage bin should be cleaned regularly and the old ice in the bottom of the bin discarded.
- Wash bin in lukewarm water. Dry thoroughly and replace.
- When replacing the bin ensure that the scoop is on the right hand side or at the front of the bin (model dependent, refer to page 31).

**Important! Many commercially available cleaning products contain solvents that may attack the plastic components of your refrigerator and cause them to crack. It is important to use only warm water and a small amount of liquid dishwashing detergent on any components inside and outside your refrigerator. Avoid using anti-bacterial cleaning products on either the interior or exterior of the cabinet as they may cause rusting of metal components and cracking of plastic components.**

### **Humidity Control System**

**Important!** When cleaning the shelf above the vegetable bins, we recommend that you do not disassemble the Humidity Control System from the shelf.

In the event that the humidity control lid (plastic lid) and humidity slides become separated from the glass shelf, follow these instructions to reassemble.

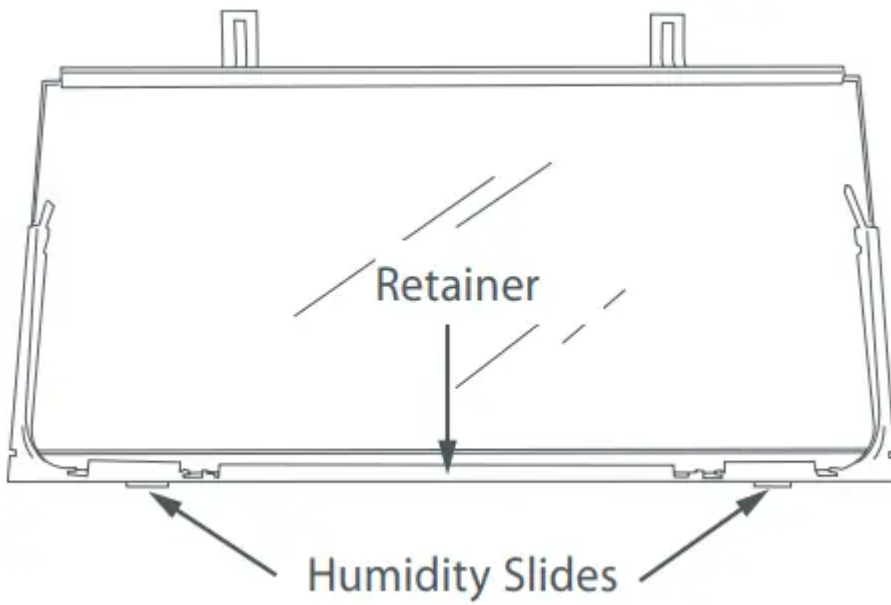

1. Turn shelf upside down
2. To attach humidity slides onto shelf front corners, fit bottom clips into shelf front trim. Next, slide sideways towards shelf until arm clips onto glass.

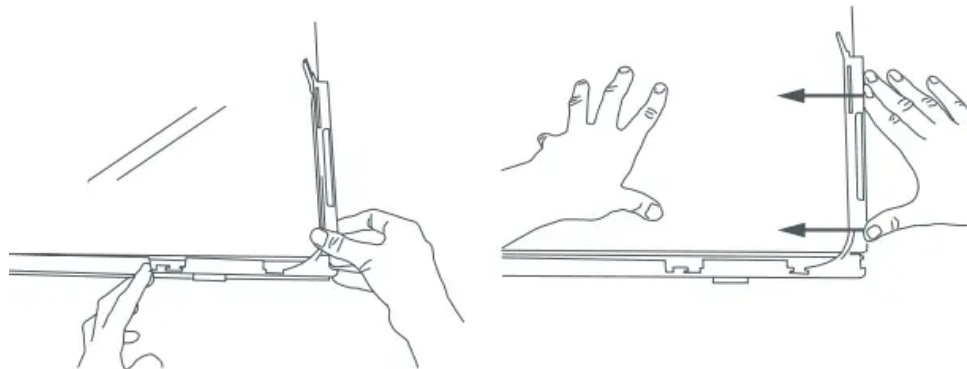

3. To attach humidity control lid – with text facing you, align lid with front of shelf. Hold lid vertically and fit front end into retainer on shelf. Ensure lid fits into retainer as well as underneath humidity slides.

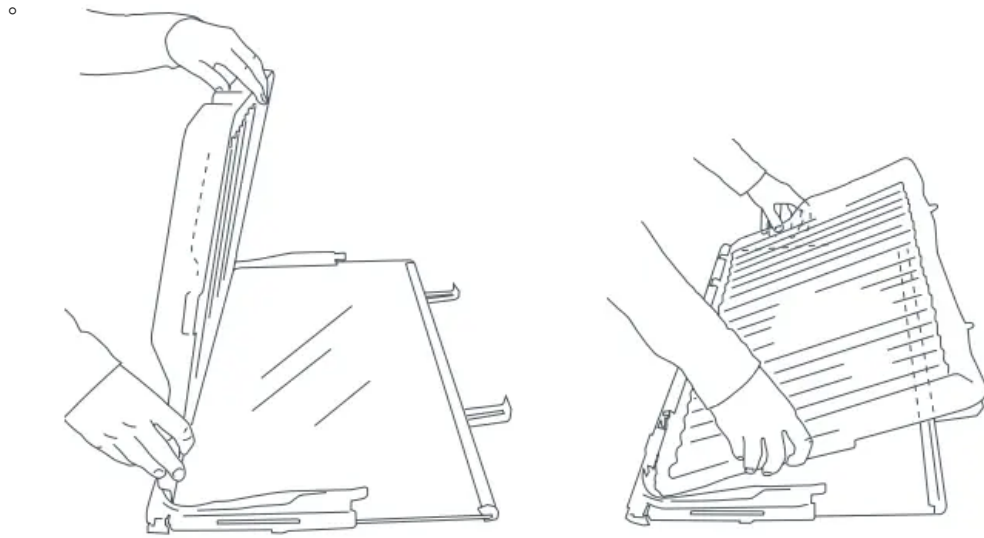

4. At the sides of the shelf, adjust humidity slide tabs so that the plastic lid is between the shelf and the tabs.
5. If clips on back of shelf are present, fasten lid with rear clips. Ensure that the cover is fully secure at front and back of shelf.



*Fig.31 Humidity Control System cleaning*

**To remove produce bins or upper freezer bins**

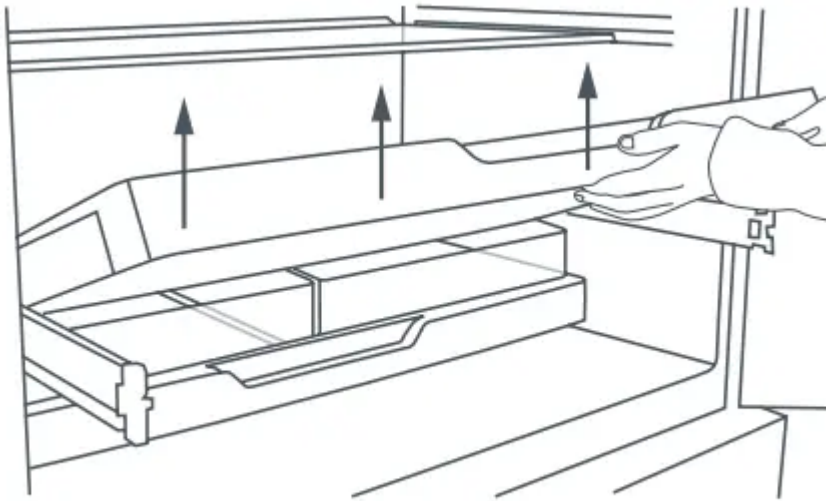

*Fig.32 Tray removal*

- To remove bins, roll out the tray and then use two hands when picking up a bin. Picking up a bin one-handed may cause it to crack or break.
- Remove the bins, wash and replace back onto trays.

#### **To remove trays**

- For ease of removal, empty food from tray/remove the bins from the tray first.
- Hold the centre front of the tray handle.
- Lift vertically to unclip from the runners and pull tray towards you to remove.
- Push both runners back into refrigerator.

#### **To replace trays**

- With the runners pushed back into the refrigerator, place the tray on top of the runners. Push the tray back slowly until you feel it clip back onto the runners.

#### **Important!**

- Ensure that trays are securely clipped onto the runners before use.
- Tray runners are pre-lubricated, and will not need to be re-lubricated during their life. Do not attempt to clean grease from the runners, as this will affect their ability to function. Do not immerse runners in water.

#### **Permanently fixed bins and trays (Freezer drawer models only)**

The freezer bins and trays in this model are permanently fixed. They cannot be removed from the freezer compartment. To clean simply wipe with a soft, damp cloth.

#### **On vacation/holiday**

- Turn the ice maker to OFF on the internal control panel (refer to page 31).

- Shut off the water supply to the refrigerator.
- On your return, turn on the water supply to the refrigerator.
- Dispense 10 litres (10 qt) of water and discard to ensure the water tank is refilled with fresh water.
- Turn on the ice maker (refer to page 31).
- Discard the first 3 harvests of ice (8 ice cubes are produced per harvest)

## **Storing food in your refrigerator**

Your refrigerator helps to extend the storage times of fresh perishable foods. The cold temperature slows down the major causes of food spoilage – namely, the growth of bacteria, moulds and yeasts, and any chemical and physical reactions.

### **Fresh food care**

The quality of food before it is placed in the refrigerator is critical to successful storage. For best results:

- Select foods that are very fresh and of high quality.
- Buy only the amount that you will use within the recommended storage time. If you buy extra, plan to freeze it.
- Ensure that food is well wrapped or covered before it is stored. This will prevent food from dehydrating, deteriorating in colour or losing flavour and will help maintain freshness. It will also prevent odour transfer. Fruit and vegetables need not be wrapped provided they are stored in the vegetable bins of the refrigerator.
- Make sure that strong smelling foods are wrapped or covered and stored away from foods such as butter, milk and cream which can be easily tainted by strong odours.
- Refrigerate fresh, perishable foods as soon as possible after purchase. If left at room temperature for any length of time the rate of deterioration will be accelerated.
- Avoid placing food directly in front of air outlets, as it may freeze and cold air needs to circulate to maintain safe food storage.
- Do not open the refrigerator door unnecessarily.
- Cool hot foods down before placing them in the refrigerator. This should be done quickly. It can be aided by placing the container of food in a bowl of ice and water; renew the ice as necessary. (Note also that hot containers may damage shelves and walls of the refrigerator).
- Store raw and cooked food in separate containers or packaging to prevent cross contamination.

### **In addition:**

- Keep the refrigerator clean. Wipe the inside walls and shelves frequently (refer to Cleaning Care) and place only clean containers in the refrigerator.
- Keep a close check on the quality of food in your refrigerator. Discard any food that shows signs of spoilage. Pay particular attention to meat, fish and poultry, as these foods are highly perishable. Use food within the recommended storage times.

### **Dairy foods and eggs**

- Most pre-packed dairy foods have a recommended 'use by/best before/best by' date stamped on them. Store them in the refrigerator and use within the recommended time.
- Butter can become easily tainted by strong smelling foods so it is best stored in a sealed container.
- Eggs should be stored in the refrigerator. For best results, especially when baking, remove the eggs from the refrigerator two hours before they are to be used.

### **Red meat**

- Place fresh red meat on a plate and loosely cover with waxed paper, plastic wrap or foil.
- Store cooked and raw meat on separate plates. This will prevent any juices lost from the raw meat contaminating the cooked product.
- Delicatessen meats should be used within the recommended storage time.



### **Poultry**

- Fresh whole birds should be rinsed inside and out with cold running water. Dry and place on a plate. Cover loosely with plastic wrap or foil.
- Poultry pieces should also be stored this way. Whole poultry should never be stuffed until just before cooking, otherwise food poisoning may result.
- Cool and refrigerate cooked poultry quickly. Remove stuffing from poultry and store separately.



### **Fish and seafood**

- Whole fish and fillets should be used on the day of purchase. Until required, refrigerate on a plate loosely covered with plastic wrap, waxed paper or foil.
- If storing overnight or longer, take particular care to select very fresh fish. Whole fish should be rinsed in cold water to remove loose scales and dirt and then patted dry with paper towels. Place whole fish or fillets in a sealed plastic bag.
- Keep shellfish chilled at all times. Use within 1 – 2 days.

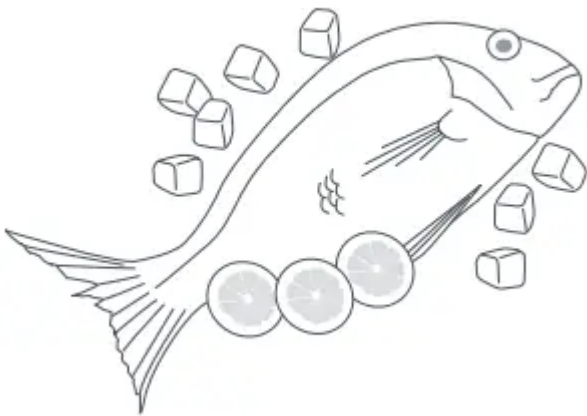

### **Precooked foods and leftovers**

- These should be stored in suitable covered containers so that the food will not dry out.
- Keep for only 1 – 2 days.
- Reheat leftovers only once and until steaming hot.

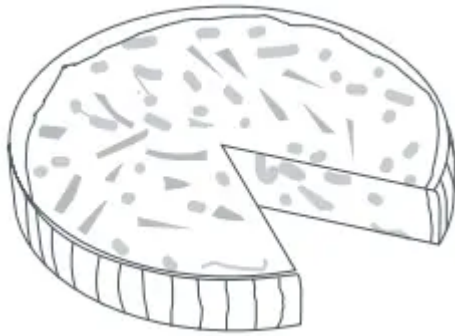

### **Fruit and vegetable bins**

- Although most fruit and vegetables keep best at low temperatures, take care not to store the following at temperatures of less than 7°C (45°F) for long periods: Citrus fruit, tropical fruit, tomatoes, cucumbers.
- Undesirable changes will occur at low temperatures such as softening of the flesh, browning, accelerated decaying and/or loss of flavour.
- Do not refrigerate avocados (until they are ripe), bananas, mangoes or pepinos.
- If possible store fruit and vegetables separately, ie fruit in one bin and vegetables in the other.
- Each fruit and vegetable bin has a humidity control slide that can be adjusted depending on what is stored in the bins. For more information on using the Humidity Control refer to page 33.

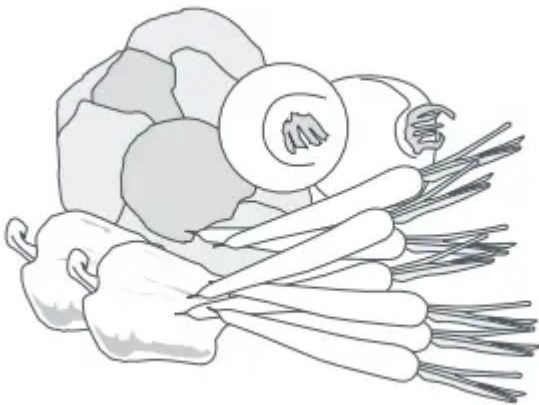

### **Storing food in your freezer**

The use of temperatures of -18°C (0°F) or colder to store food means that the food can be kept for longer periods than when refrigeration temperatures are used. This is because the growth of bacteria, moulds and yeasts are stopped, and chemical and physical reactions are severely restricted at such low temperatures.

## Frozen food care

For best results:

- Choose only high quality foods that freeze well.
- Store at -18°C (0°F) or colder. Take care to maintain this low storage temperature, eg try to avoid opening the freezer door unnecessarily. If your ice cream is soft you are running your freezer too warm.
- Leave space at the top of containers, glass jars or plastic bags containing liquids or semi-solid foods. These expand as they freeze. Usually 20 – 50 mm (1 – 2”) head space is recommended. Seal. Ideally, remove all the air from the package after food is frozen.
- Packages or containers of solid foods should have the air removed from them and be sealed tightly before freezing.
- Use the FAST FREEZE function when freezing fresh food. This helps to speed up the freezing process, giving optimum freezing results. It is recommended that the function is activated approximately 2 hours before required. For more information refer to page 26.
- Freeze immediately or as quickly as possible. Freeze only small quantities of food at any one time. For best results we recommend that only 1 kg (2.2 lb) of food be frozen per 25 L (0.9 cu.ft) of freezer storage volume at any one time. (About 3 kg (7 lb) in small freezers and 4 kg (9 lb) in larger freezers). For faster freezing in ActiveSmart™ models, we recommend that fresh food is placed at the top of the freezer compartment close to the air vent.
- Thaw foods preferably in a refrigerator, or using a microwave oven or multifunction oven.
- Keep a constant turnover of food. Use older items of food first and do not exceed recommended storage times.
- Use good quality freezer proof packaging to maintain food quality.
- If food is only covered in plastic film place inside a freezer-proof plastic bag.

### Recommended freezer storage times

These times should not be exceeded.

#### Months & Type of food stored

- **1**
  - Bacon, casseroles, milk
- **2**
  - Bread, ice cream, sausages, pies – (meat and fruit), prepared shellfish, oily fish
- **3**
  - Non-oily fish, shellfish, pizza, scones and muffins

- 4
  - Ham, cakes, biscuits, beef and lamb chops, poultry pieces
- 6
  - Butter, vegetables (blanched), eggs whole and yolks, cooked crayfish, minced meat (raw), pork (raw)
- 12
  - Fruit (dry or in syrup), egg whites, beef (raw), whole chicken, lamb (raw), fruit cakes

### **Meat, poultry and game**

- Do not try to freeze more than 1 kg (2.2 lb) meat per 25 L (0.9 cu.ft) of freezer storage volume at any one time. Meat must be frozen quickly in order to maintain its texture.
- Do not stuff poultry before freezing.
- Red meat can be cooked from frozen, or from the partly or completely thawed states. Remember to allow extra cooking time if cooking from frozen.
- Always thaw poultry completely before cooking.



### **Fish**

- Fish is best frozen commercially. If, however, you do want to freeze fish at home, make sure the fish is very fresh and of high quality.
- Clean, scale and preferably leave whole. All fish should be wrapped in two layers of packaging as depending on the type of fish, odours and flavours can be readily transferred either to or from it. Seal well.
- For best results, cook from either the frozen or partly thawed state.

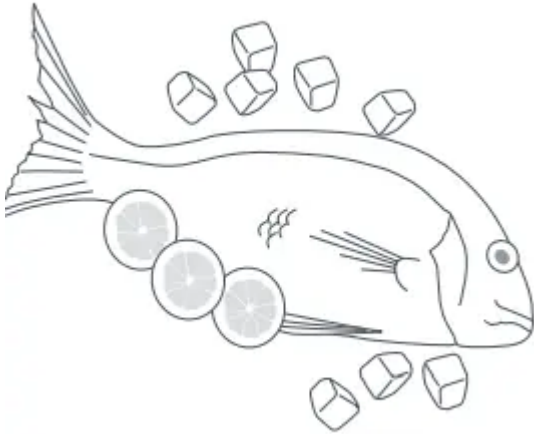

## Fruit

- Choose high quality, mature, and ready to eat fruit. Preferably select varieties recommended for freezing.
- Avoid unripe and over-ripe fruit.
- The way fruit is packed depends on how it is to be used. Fruits packed in syrup are ideal for desserts, whereas fruits packed without sugar are better used for cooking. Most fruits can be stored for 8 – 12 months.



## Vegetables

- Most vegetables freeze well, although 'salad' vegetables lose their crispness. Other vegetables, eg celery, onion and tomatoes, should only be used in cooked dishes as they soften on freezing.
- Freeze only high quality, mature, ready-to-eat vegetables.
- Sort and discard any vegetables that are damaged.
- It is necessary to blanch most raw vegetables prior to freezing.
- Blanching involves a short cooking period during which vegetable enzymes are destroyed. If these enzymes are not destroyed they cause undesirable physical and chemical changes during freezer storage

- Vegetables can be blanched in boiling water, steam or microwave oven. If using boiling water, boil vegetables for 2 – 4 minutes and cool quickly.
- In general, frozen vegetables are best cooked from their frozen state.

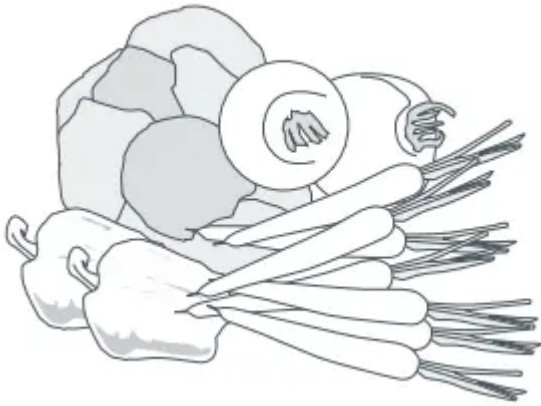

### Prepared and cooked foods

- Most cooked foods can be frozen but it is not recommended to freeze the following: Cooked egg white, custards, cream fillings and milk puddings, gelatine or jelly-like dishes, mayonnaise and similar salad dressings, meringue toppings. These tend to separate on thawing.

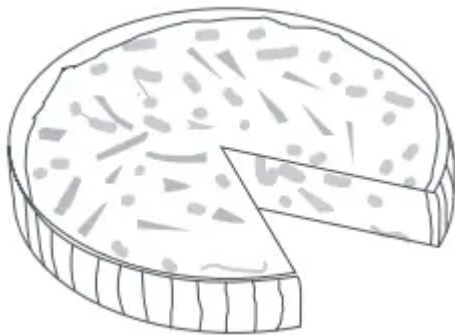

## ActiveSmart™ user warnings and sounds

### User warnings



Faults



In the unlikely event a fault occurs the  icon will illuminate on the internal control panel and an alarm will sound when the fresh food compartment door is opened.

- Please count the number of beeps made when the fresh food compartment door is opened. Please also take note of the number and sequence of temperature lights displayed on the internal control panel and contact our Customer Care Centre.

- 

To silence the fault alarm press any button on the internal control panel. The  icon will remain illuminated until the fault is corrected.

### Normal refrigerator sounds

ActiveSmart™ refrigerators, with their excellent energy ratings and cooling performance, can produce sounds somewhat different to your old refrigerator.

#### Normal operational sounds include:

- Fan air flow sound. ActiveSmart™ refrigerators have fans which change speed depending on demand. During cooling periods, such as after frequent door openings, fans circulate the cold air in the refrigerator and freezer compartments producing some air flow sound. This is quite normal.
- Cracking or popping which may occur when the defrost function is operating.
- Running water sound. This is the liquid refrigerant in the system and can be heard as a boiling or gurgling noise.
- An audible hissing sound after closing the freezer door. This is due to the pressure difference between the warm air that has entered the cabinet and suddenly cooled, and the outside air pressure.
- Gasket noises which can normally occur due over time due to a build up of dirt and/or grime. Clean gasket regularly to minimise these noises occurring.
- Other sounds may be heard for the following reasons:
  - Cabinet not level
  - Floor uneven or weak
  - Bottles or jars rattling on shelves
- If this is your first refrigerator with an ice maker, you will hear occasional sounds that may be unfamiliar. They are normal ice making sounds and are not cause for concern.
- The following sounds are normal with the operation of an ice maker:
  - Motor operation (low humming).

- Running water as the ice maker and/or water tank fills.
- Water valve opening and closing (hissing sound).
- Ice being loosened from the ice moulding tray (cracking).
- Ice dropping into bin (clunking).

## Troubleshooting

If there is a problem with your appliance, please check the following points before contacting your local Fisher & Paykel Authorised Repairer or the Customer Care Centre.

### All models



#### 1. Appliance does not operate.

- No electricity at power outlet.
  - Check that the plug is correctly connected and power switched on.
  - Check another appliance at the same outlet.
  - Check house fuse.

#### 2. Light not working.

- Light not functioning.
  - The LED light cannot be serviced by the user. Contact your Fisher & Paykel Dealer or Fisher & Paykel Authorised Repairer.
- Refrigerator not working.
  - Check refrigerator is turned on at wall

#### 3. Light and display not working.

- Product in SABBATH MODE.
  - Press and hold  ,  and  together for 4 seconds.

#### 4. Motor operates for long periods.

- Hot weather.
- Frequent door openings.
- Large amount of food recently added.
  - Minimise door openings to allow temperature to stabilise.
- Temperature control set too low.
  - See Temperature control section (page 23).

- Doors not sealing properly.
  - Check that cabinet is level and gasket seals are clean.

5. Storage compartments too warm.

- Temperature setting not correct.
  - See Temperature control section (page 23).
- Frequent door openings.
- Large amount of food recently added.
  - Minimise door openings to allow temperature to stabilise.

6. Food freezing in the refrigerator.

- Temperature setting not correct.
  - See Temperature control section (page 23).
- Food placed directly in front of air outlets.
  - Move chill sensitive foods away from the centre back of the shelves.

7. Unfamiliar noises.

- Cabinet not stable or level.
- Freezer is defrosting.
  - See Installation section (pages 7 – 11) or refer to Sounds (page 44)

8. Water in the vegetable bins.

- Condensation is formed by the water produced by fruit and vegetables.
  - A small amount of condensation is beneficial for fruit and vegetable storage.
  - Wipe out water with a cloth.

- Set humidity slide to low humidity setting 

9. Exterior of cabinet is warm.

- This is normal.

10. Warm area on central door seal (French door models only).

- This is normal.

11. Condensation on outside of refrigerator/ freezer.

- Not unusual during periods of high humidity.
  - Wipe dry

12. Condensation inside fresh food compartment.

- Frequent or long door openings.
  - Minimise door openings.
- Door gasket leaking.
  - Check that gasket is sitting flat and sealing tightly.
- Not unusual during periods of high humidity.
  - Wipe dry

13. Door handles out of alignment.

- With time and usage, movement may occur.
  - See Installation instructions – Stability instructions (pages 7 – 11).

14. Tray/bin does not slide in and out evenly.

- Packaging trapped.
  - Check to ensure no food or packaging is trapped behind the tray/bin.
- Runners not extending fully.
  - Holding onto sides of tray/bin, extend the runners fully by using a firm pull – this will reset the runner.

15. Taste of odour in ice cubes.

- Transfer of odour/taste from strong smelling foods.
  - Wrap or cover strong smelling foods.

16. Excessive gasket noise.

- May be due to a build up of dirt and/or grime.
  - Clean gasket and apply Armorall.

17. Door not closing.

- An obstruction is blocking door closing.
  - Move obstruction.
- Soft closing door feature failure (soft closing door models only).
  - Soft closing door feature is not serviceable by user.

**Ice & Water models only**

1. Automatic ice maker does not work.

- Ice maker has not been turned on.
  - Switch on ice maker (refer to page 31).

- Bin is in the wrong way or there is no bin in place.
  - Place bin so scoop is on the right side.
- Ice bin sits directly under ice maker on top left side of freezer.
  - Water supply turned off or not connected. Connect water supply.
- Freezer compartment not working.
  - Contact Customer Care.
- Water pressure too low.
  - Check water pressure.
- Water line kinked/squashed.
  - Check water line for kinks/squashing.
- Filter clogged.
  - Water filter may need replacing

## 2. Ice cubes have odour/taste

- Unsealed packages may be transmitting odour/taste.
  - Old cubes need to be discarded.
  - Ensure food packaging is sealed.
- Interior of freezer needs cleaning.
  - Ice storage bin needs to be emptied and washed.
  - Clean refrigerator (refer to page 36).
- Poor taste from incoming water.
  - Filter may need changing.
  - A new filter may need to be installed. Force 2 – 3 ice tray flips (refer to page 31).

## 3. Slow ice cube freezing.

- Door may have been left ajar.
  - Close door.
- Freezer compartment too warm.
  - Turn temperature to a colder setting (refer to page 23).

#### 4. Warm spot on central door seal. (French door models only)

- You may feel a warm spot at times on the central seal between the two refrigerator doors.
  - This is perfectly normal and is part of the normal refrigerator operation.

#### 5. Wet ice/ ice clumping.

- Low water pressure.
  - Check water pressure.
- Filter blocked.
  - Replace filter (refer to pages 29 – 30).
- Long freezer door openings.
  - High ambient temperature.
  - Ice bin left out of freezer compartment for a length of time. Ice will stick together over time.
  - Gently tap ice with scoop to unstick or, if large clumps occur, empty ice bin and make new ice.

#### 6. Water has poor taste/odour.

- Refrigerator not used for an extended period.
  - Dispense 10 L (10 qt) of water so fresh water supply is replenished.

#### 7. Water dispenser does not work.

- Water supply turned off or not connected.
  - Turn water on.
  - Press dispenser for 2 minutes to remove trapped air from water line and to fill the water system.
- Supply line may be blocked. On first installation there may be air in water system.
  - Check supply for kinks or leaks.
  - To remove air, run 3 litres (3 qt) of water through the dispenser.
- Filter may be blocked and need replacing.
  - Replace filter (see back of this booklet for Customer Care contact details).

- DISPENSER LOCK activated.

-  Press and hold the button for 4 seconds.

- Water frozen in tank.

- Increase temperature to a warmer setting in fresh food compartment and freezer

#### 8. Water in first glass is warm.

- Water dispenser not used for extended period.

- Discard first glass of water dispensed.

- Tank capacity used recently.

- Allow water time to cool.

#### 9.

Filter warning light  is flashing.

- Filter needs replacing.

- Replace filter as soon as possible (refer to pages 29 – 30).

#### 10. Drips overflow drip-shelf.

- Air trapped in tank.

- Flush 3 L (3 qt) water through dispenser, stopping intermittently.

- New filter installed.

- Flush 10 L (10 qt) water through filter and then 3 L (3 qt) through dispenser.

#### 11. Water flow rate has slowed down.

- Filter cartridge is restricted.

- Replace filter as soon as possible (see pages 29 – 30).

#### 12. Ice buildup inside freezer compartment.

- Freezer door not closing tightly.

- Arrange items in freezer so door can close tightly.

- Check and clean door gasket seal.

#### 13. Ice maker makes unfamiliar sounds or seems too loud.

- Normal ice maker operation.

- Refer to refrigerator sounds (refer to page 44).

14. Ice boost function not increasing rate of ice production.

- Ambient temperature very warm.
- Refrigerator is in high usage.
  - Minimise door openings.

**Warning**

This content is compiled from multiple sources and is provided for reference purposes only. It may not be complete or fully applicable to all situations. If you are unable to resolve your issue, please contact the product manufacturer or an authorized service provider for official support.

