



## IMPORTANT SAFEGUARDS

Follow basic safety precautions, including:

This appliance can be used by children aged from 8 years and above and persons with reduced physical, sensory or mental capabilities or lack of experience and knowledge if they have been supervised/instructed and understand the hazards involved. Children shall not play with the appliance.

Cleaning and user maintenance shall not be done by children unless they are older than 8 and supervised. Keep the appliance and cable out of reach of children under 8 years.

Misuse of the appliance may cause injury.

The surfaces of the appliance will get hot. Residual heat will keep the surfaces hot after use.

Do not use this appliance near bathtubs, showers, basins or other vessels containing water.

If the cable is damaged, it must be replaced by the manufacturer, its service agent, or someone similarly qualified, to avoid hazard.

The surface of the heating element is subject to residual heat after use.

Use the appliance according to these instructions. Any misuse may cause potential injury, electric shock or other hazards.

This appliance can be used by persons with reduced physical, sensory or mental capabilities or lack of experience and knowledge if they have been given supervision or instruction concerning use of the appliance in a safe way and understand the hazards involved.

## PARTS

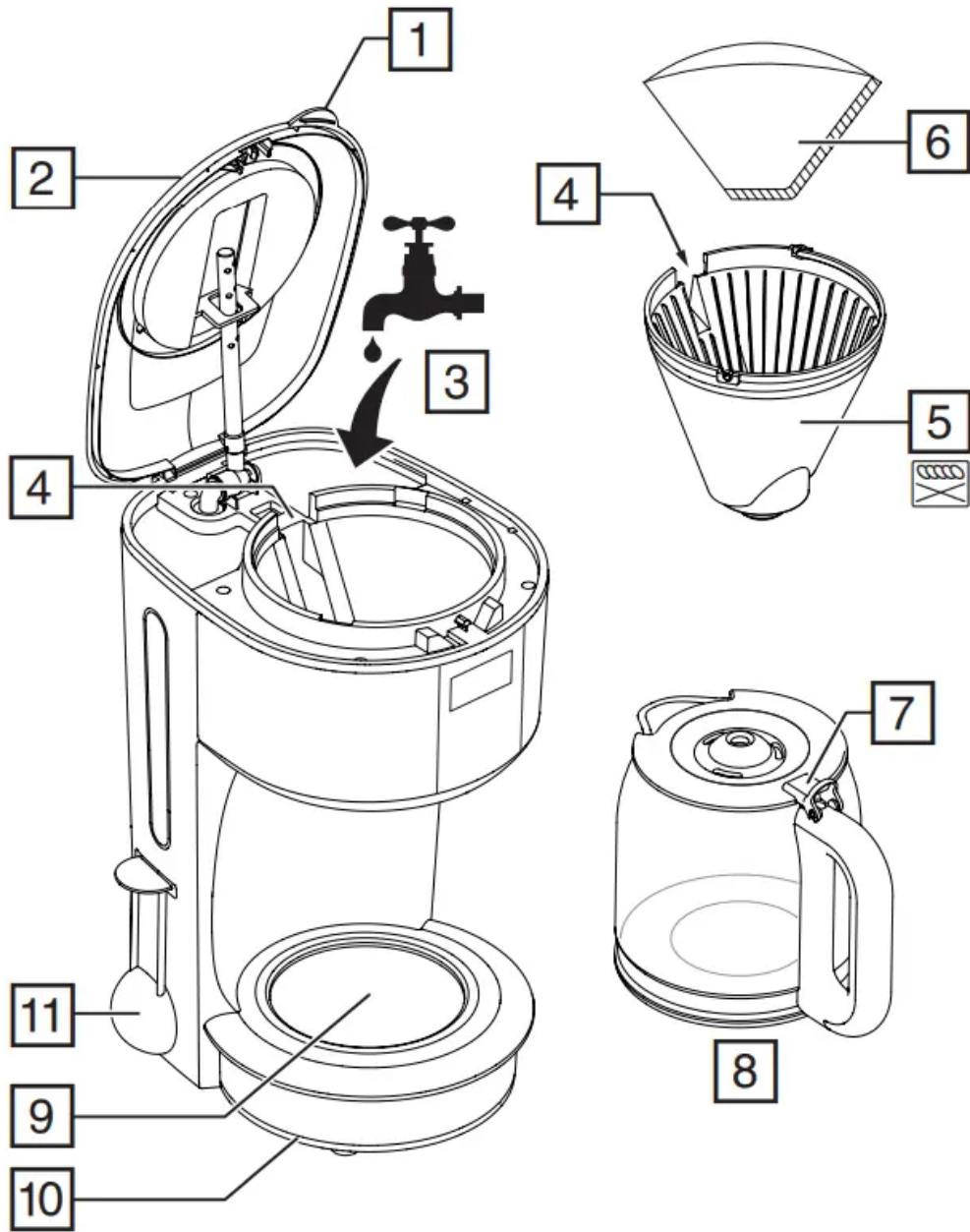

1. Grip
2. Lid
3. Water
4. Slot
5. Filter holder
6. Paper filter #4 (not supplied)
7. Press
8. Carafe

9. Hotplate
10. Status light
11. Scoop

Dishwasher - top rack

## BEFORE USING FOR THE FIRST TIME

Fill the reservoir to the max mark, and run the appliance without coffee.



## FILLING

1. Remove the carafe from the hotplate.
2. Open the lid.
3. Fill the reservoir with the exact amount of water required. Note that the brewing process will use all of the water that you put in the reservoir.
4. Make sure that the filter holder is pressed down all the way into position. It will click when correctly installed.
5. The reservoir is calibrated to give 12 large cups (at 125ml per cup) and 18 small cups (at 83ml per cup). For each large cup, add 6g of ground filter coffee and for each small cup add 4g.
6. Close the lid.
7. Replace the carafe on the hotplate.

## SWITCH ON

1. Put the plug into the power socket.
2. 12:00 will blink on the display.

## COFFEE NOW

1. Ignore the clock.
2. If you're making less than 5 cups of coffee, press the  button.  will show on the display. It slows the brewing process, so your coffee will have the same strength as coffee from a full carafe.
3. Press the  button. The button will light up.
4. Shortly afterwards, coffee will start to drip into the carafe.
5. When it's done, the hotplate will keep the carafe warm.

6. If you want to stop the coffee maker while it's brewing, press the  button.

## STATUS LIGHT

The status light will change colour to show how fresh the coffee is.

blue = brewing / 0-30 minutes since brewing

blue (blinking) = 30-40 minutes since brewing



## AUTO SHUT-OFF/SLEEP MODE

About 40 minutes after brewing finishes, the appliance will shut down.

After 15 seconds of inactivity, the appliance will go to sleep.

To wake the appliance, press the min button.

## COFFEE LATER

1. The clock will retain its settings until the coffee maker is unplugged.
2. It's a 24 hour clock.
3. Set the clock to the correct time.
4. Use the **h** and **min** buttons to set the correct hour and minute.
5. Set the timer to the time you want to start brewing.
6. Press the  button.
7. Use the **h** and **min** buttons to set the correct hour and minute.
8. If you don't press either the **h** or **min** buttons within 5 seconds, the coffee maker will revert to "normal", and the time will show. You'll have to press the  button, and start again.
9. If you're making less than 5 cups of coffee, press the B button.  will show on the display.

## ACTIVATION

1. Press the **AUTO** button.
2. **AUTO** will show on the display.
3. At the time you set, the  button will light up, and the coffee maker will start up.
4. To cancel the timer before brewing has started, press the button again.



## REMEMBER

If you forget what time you've set it to, press and hold the  button, then release it.

## A QUICK CUP

You can remove the carafe at any time. To prevent the filter holder overflowing, replace the carafe on the hotplate within about 20 seconds.

## A STRONGER BREW

If you're making 5 cups or more, you may use the  function to make the brew slightly stronger. Just press the  button once.  will show on the display.

## CARE AND MAINTENANCE

1. Unplug the appliance and let it cool.
2. Tip the contents of the filter holder into the bin.
3. Wipe all surfaces with a clean damp cloth.
4. Press the lever at the rear of the carafe lid, above the handle, to open the carafe lid.
5. Hand wash the carafe and filter holder.
6. Replace the filter holder. Make sure that the filter holder is pressed down all the way into position. It will click when correctly installed.
7. Close the lid, and press down to lock it.

You may wash these parts in the top rack of a dishwasher.



## SELF CLEAN

To prevent scale building up, use the self clean function at least monthly in normal water areas, more often in hard water areas.

Ensure the kitchen is well ventilated, as heating vinegar causes an unpleasant smell.

This operation will take 35-45 minutes.

1. Mix 6 cups of white vinegar with 4 cups of water in the carafe.
2. Pour the mixture into the reservoir.
3. Close the lid.
4. Replace the carafe on the hotplate.

5. Put the plug into the power socket.
6. Press the  button.  will show on the display.
7. Part of the mixture will come through. The remainder will soak in the boiler for 30 minutes, then come through.
8. At the end of the operation the appliance will switch itself off.
9. Fill the reservoir to the **max** mark, and run the appliance without coffee.
10. Do this 2 or 3 times, till the vinegar smell has gone.

Products returned under guarantee with faults due to scale will be subject to a repair charge.

## RECYCLING

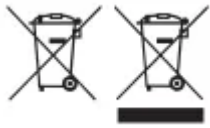

To avoid environmental and health problems due to hazardous substances, appliances and rechargeable and non-rechargeable batteries marked with one of these symbols must not be disposed of with unsorted municipal waste. Always dispose of electrical and electronic products and, where applicable, rechargeable and non-rechargeable batteries, at an appropriate official recycling/collection point.

## SERVICE

If you ring Customer Service, please have the Model Number to hand, as we won't be able to help you without it. It's on the rating plate (usually underneath the product).

The product isn't user-serviceable. If it's not working, read the instructions, check the plug fuse and main fuse/circuit breaker. If it's still not working, consult your retailer.

If that doesn't solve the problem – ring Customer Service – they may be able to offer technical advice.

If they advise you to return the product to us, pack it carefully, include a note with your name, address, day phone number, and what's wrong. If under guarantee, say where and when purchased, and include proof of purchase (till receipt). Send it to:

Customer Service

Spectrum Brands (UK) Ltd

Fir Street, Failsworth, Manchester M35 0HS

## GUARANTEE

Defects affecting product functionality appearing within the guarantee period will be corrected by replacement or repair at our option provided the product is used and maintained in accordance with the instructions. Your statutory rights are not affected. Guarantee period = 2 years from first

retail purchase. To claim an extra 1 year guarantee, register your product online within 28 days of purchase.

**Warning**

This content is compiled from multiple sources and is provided for reference purposes only. It may not be complete or fully applicable to all situations. If you are unable to resolve your issue, please contact the product manufacturer or an authorized service provider for official support.

---

Document generated by [ManualsFile](#)

