

Basic operation

Checking part names and functions

X491BHS

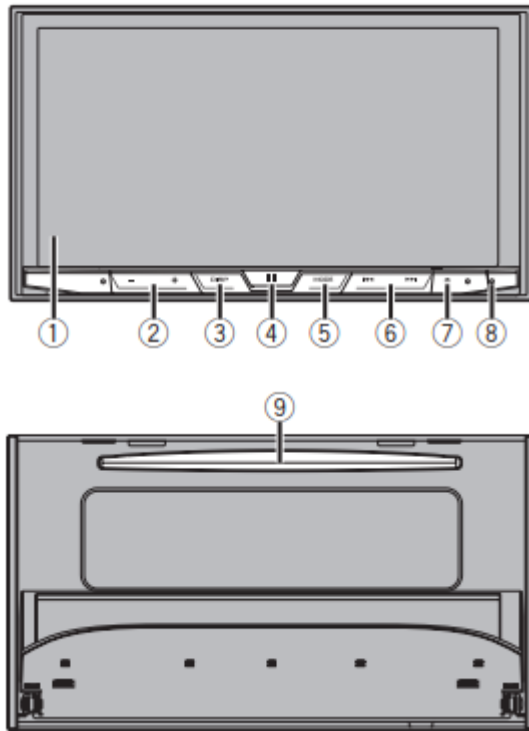



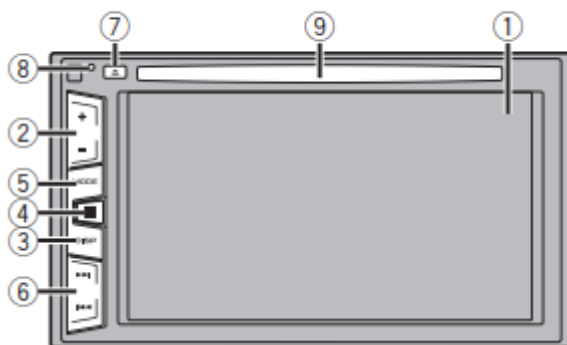

X391BHS

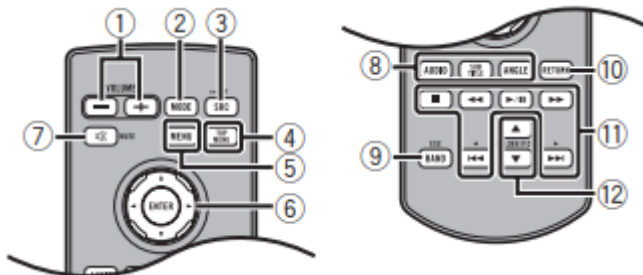

1	LCD screen	
2	Volume (+/-) button	
3	DISP button	On the AV operation screen, press to turn the display off. On the Application screen or navigation mode, press to display the side control bar. Press and hold to turn the display off. <input type="checkbox"/> When the display is turned off, touch the screen to revert to the original screen.
4	☰ button	Press to display the top menu screen. Press and hold to activate the voice recognition function. ➡ Refer to <i>Using the voice recognition function (for iPhone)</i> on page 15
5	MODE button	Press to switch between the Application screen and the AV operation screen. Press and hold to switch to the camera view mode.
6	TRK (⏮ ⏭) button	Press to return to the previous track (chapter) or go to the next track (chapter). Press and hold to perform fast reverse or fast forward. Press to answer or end a call.
7	▲ button	
8	RESET button	➡ Refer to <i>Resetting the microprocessor</i> on page 6
9	Disc-loading slot	➡ Refer to <i>Inserting and ejecting a disc</i> on page 8

Remote control



1	Volume (+/-)	
2	MODE	Press to switch between the Application screen and the AV operation screen. Press and hold to switch to the camera view mode.
3	SRC	Press to cycle through all the available sources. Press and hold to turn the source off.
4	TOP MENU	Returns to the top menu during DVD playback.
5	MENU	Displays the DVD menu during DVD playback.
6	Thumb pad	Selects a menu on the DVD menu.
7	MUTE	
8	AUDIO SUBTITLE ANGLE	Changes the audio language, subtitle language or viewing angle during DVD playback.
9	BAND/ ESC	Selects the tuner band when tuner is selected as a source. Cancels the control mode of functions. Switches between media file types when playing the data of Disc, USB.
10	RETURN	Returns to the specified point and begins playback from there.
11		Pauses or resumes playback.
	 or	For audio: Press and hold to perform fast reverse or fast forward. For video: Press to perform fast reverse or fast forward.
	 or	Press to return to the previous track (chapter) or go to the next track (chapter). Press to answer or end a call.
		Stops playback. If you resume playback, playback will start from the point where you stopped. Touch the key again to stop playback completely.
12	FOLDER/P. CH	Selects the next or previous disc or folder. Recalls radio station frequencies assigned to preset channel keys.

Notes on using the LCD panel

WARNING Do not use with the LCD panel left open. It may result in injury in the event of an accident.



CAUTION

- Keep hands and fingers clear of this product when opening, closing, or adjusting the LCD panel. Be especially cautious of children's hands and fingers.
- Do not open or close the LCD panel by force. It may cause a malfunction.
- Do not operate this product until the LCD panel has completely opened or closed. The LCD panel may stop at that angle for safety.
- Do not place a glass or can on the open LCD panel.

Adjusting the LCD panel angle

X491BHS

1. Press the button.

2. Touch  or  to adjust the angle of the LCD panel.
3. Touch .

Returns to the previous screen



Inserting/ejecting/connecting media

CAUTION Do not insert anything other than a disc into the disc-loading slot.

Inserting and ejecting a disc

Inserting a disc

X491BHS

1. Press the  button.
2. Touch  to open the LCD panel.
3. Insert a disc into the disc-loading slot.

Ejecting a disc

X491BHS

1. Press the button.
2. Touch to open the LCD panel.
3. Remove the disc, and press the button.

Inserting a disc

X391BHS

1. Insert a disc into the disc-loading slot.

Ejecting a disc

X391BHS

1. Press button to eject a disc.

Plugging and unplugging a USB storage device

- This product may not achieve optimum performance with some USB storage devices.
- Connection via a USB hub is not possible.
- A USB cable is required for connection.

1. Pull out the plug from the USB port of the USB cable.
2. Plug a USB storage device into the USB cable.

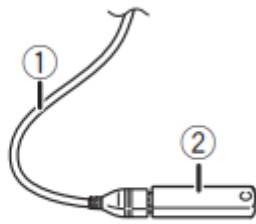

- ① USB cable
- ② USB storage device

Check that no data is being accessed before pulling out the USB storage device.

How to use the screens

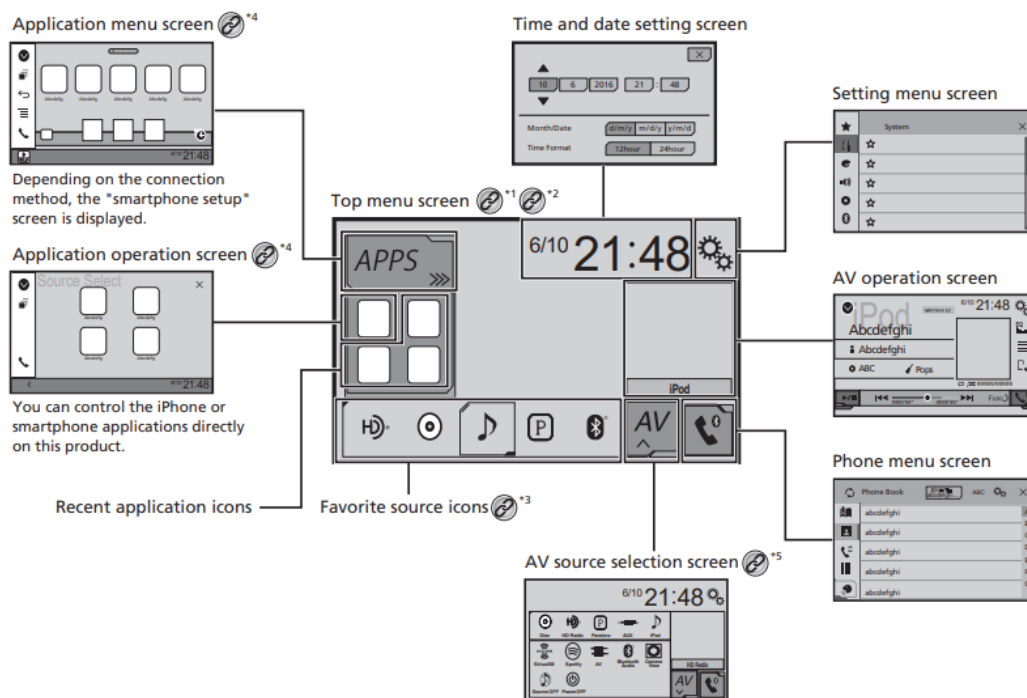

Supported AV source

You can play or use the following sources with this product.

- HD Radio (HD Radio™ tuner)
- ROM (compressed audio files)
- DVD-Video
- USB

The following sources can be played back or used by connecting an auxiliary device.

- iPod
- Spotify®
- Pandora®

- Bluetooth audio
- SiriusXM® Satellite Radio
- AV input (AV)
- AUX

Displaying the AV operation screen

1. Press .
2. Touch the AV operation key.

The AV operation screen appears.



- ① **Displays the source list.**

Selecting a source

Source on the AV source selection screen

1. Display the “AV source selection” screen.



2. Touch the source icon.

When you select “Source OFF”, the AV source is turned off.

Source on the source list

1. Display the source list. Refer to Displaying the AV operation screen on page 11
2. Touch the source key.

When you select “Source OFF”, the AV source is turned off.

Changing the display order of sources

Changing the display order of source icons

1. Display the “AV source selection” screen.



2. Touch and hold a source icon, and drag the icon to the desired position.

Changing the display order of source keys

1. Display the source list. Refer to Displaying the AV operation screen on page 11
2. Touch .
3. Drag the source key to the desired position.

Using the touch panel

You can operate this product by touching the keys on the screen directly with your fingers.

- To protect the LCD screen from damage, be sure to touch the screen only with your finger gently.

Common touch panel keys

 : Returns to the previous screen.

 : Closes the screen

Operating list screens

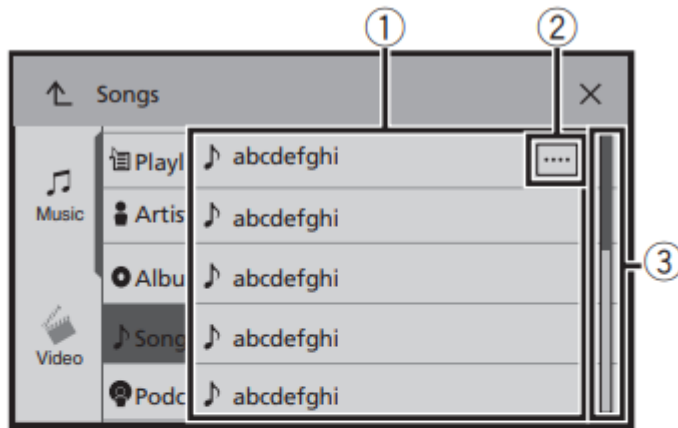

- ① Touching an item on the list allows you to narrow down the options and proceed to the next operation.
- ② Appears when all characters are not displayed on the display area.
If you touch the key, the rest are scrolled for display.
- ③ Appears when items cannot be displayed on a single page.
Drag the slider bar or the list to view any hidden items.

Operating the time bar

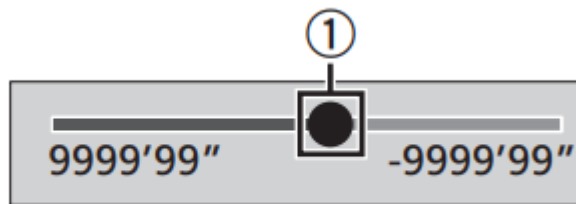

- ① You can change the playback point by dragging the key.
 - Playback time corresponding to the position of the key is displayed while dragging the key

Switching the operation panel

1. Touch .

The hidden function keys appears.

- This key does not appear for some AV sources.

Registration and connection of Bluetooth® device

Displaying the “Bluetooth” screen

1. Press .
2. Touch , and then . The “Bluetooth” screen appears.

Registering your Bluetooth devices

- If three devices are already paired, “Memory Full” is displayed. Delete a paired device first.

Refer to Deleting a registered device on page 12

1. Activate the Bluetooth wireless technology on your devices.
2. Display the “Bluetooth” screen. Refer to Displaying the “Bluetooth” screen on page 12
3. Touch [Connection].
4. Touch . The system searches for Bluetooth devices waiting for a connection and displays them in the list if a device is found.
5. Touch the Bluetooth device name.

After the device is successfully registered, a Bluetooth connection is established by the system. Once the connection is established, the device name is displayed on the list.

- If your device supports SSP (Secure Simple Pairing), a sixdigit number appears on the display of this product. Touch [Yes] to pair the device.
- The Bluetooth connection can be also made by detecting this product from the Bluetooth device. Before registration, make sure that “Visibility” in the “Bluetooth” menu is set to “On”. For details on a Bluetooth device operations, refer to the operating instructions supplied with the Bluetooth device. Refer to Switching visibility on page 13
- Two cellular phones can be connected to this product at the same time. Refer to Switching the connected Bluetooth device on page 13
- If you try to connect an unconnected cellular phone while two cellular phones are already connected, the first one of the two connected cellular phones will be disconnected and the unconnected cellular phone will be connected instead

Setting Bluetooth device auto connection

This function connects the last connected Bluetooth device to this product automatically as soon as the two devices are less than a few meters apart.

The default setting is “On”.

- If two Bluetooth devices were connected the last time, the two devices are connected to this product automatically in the order that they are registered in the device list.
1. Display the “Bluetooth” screen. Refer to Displaying the “Bluetooth” screen on page 12
 2. Touch [Auto Connect] to switch “On” or “Off”.

Deleting a registered device

CAUTION Never turn this product off while the paired Bluetooth device is being deleted.

1. Display the “Bluetooth” screen. Refer to Displaying the “Bluetooth” screen on page 12

2. Touch [Connection].

3. Touch .

Connecting a registered Bluetooth device manually

Connect the Bluetooth device manually in the following cases:

- Two or more Bluetooth devices are registered, and you want to manually select the device to be used.
 - You want to reconnect a disconnected Bluetooth device.
 - Connection cannot be established automatically for some reason.
1. Activate the Bluetooth wireless technology on your devices.
 2. Display the “Bluetooth” screen. Refer to Displaying the “Bluetooth” screen on page 12
 3. Touch [Connection].
 4. Touch the name of the device. To disconnect the device, touch the name of the connected device in the list

Switching the connected Bluetooth device

After registering and connecting the Bluetooth devices to this product, you can switch among the devices using the switch devices key in the phone function and some audio sources.





- You can register up to three Bluetooth devices on this product. Refer to Registering your Bluetooth devices on page 12
- You can connect one of the registered devices to this product. In cases where the registered device is equipped with a phone function, a total of two devices can be connected at the same time when using the phone function. If two of the three registered devices are already connected, you can connect the remaining third device to use the audio function only from the switch devices key on the audio source screen.
- The icon for the cellular phone currently being used is displayed on the “Phone menu” screen. If you connect two cellular phones to this product at the same time, you can switch between the cellular phones using the switch devices key. The contents of the phone menu are memorized for each connected cellular phone. Refer to Hands-free phoning on page 14
- The switch devices key will appear for some audio sources. The audio source may automatically switch to another source depending on the selected device

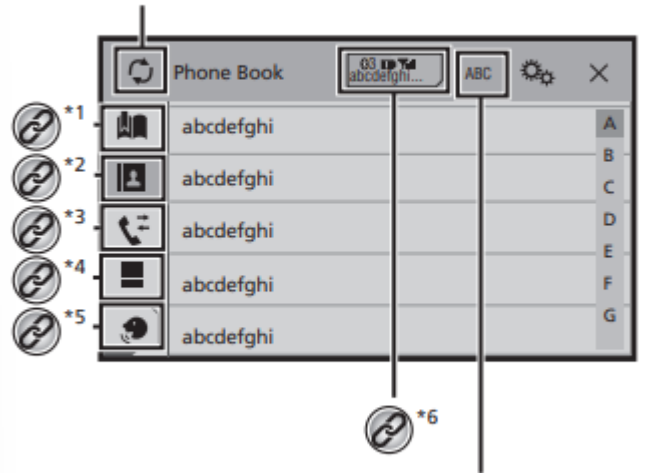

Hands-free phoning

 Synchronizes the contacts on this product's phone book with the contacts on your phone manually.



 Switches the search language to English or system language.

-  *1 Switches to the preset dial screen.
➤ Refer to *Using the preset dial lists* on page 14
-  *2 Switches to the phone book list.
➤ Refer to *Calling a number in the phone book* on page 14
-  *3 Switches to the missed, received and dialed call lists.
➤ Refer to *Dialing from the history* on page 14
-  *4 Switches the mode to enter the phone number directly.
➤ Refer to *Direct dialing* on page 14

-  *5 Switches to the voice recognition function (for iPhone).
➤ Refer to *Using the voice recognition function (for iPhone)* on page 15
-  *6 If you connect two cellular phones to this product at the same time, you can switch between the cellular phones using the switch devices key. The following items are displayed on the key.
 - Name of the current cellular phone
 - List number of the current cellular phone
 - Battery status of the current cellular phone
 - Reception status of the current cellular phone
 ➤ Refer to *Switching the connected Bluetooth device* on page 13

CAUTION

For your safety, avoid talking on the phone as much as possible while driving.

To use this function you need to connect your cellular phone to this product via Bluetooth in advance. Refer to *Registration and connection of Bluetooth® device* on page 12

Displaying the Phone menu screen



1. Press .
2. Touch .

The Phone menu screen appears.

Making a phone call

You can make a phone call in many different ways.





Direct dialing

1. Display the “Phone menu” screen. Refer to Displaying the Phone menu screen on page 14
2. Touch .
3. Touch the number keys to enter the phone number.
4. Touch  to make a call.
5. Touch  to end the call.

You may hear a noise when you hang up the phone.

Receiving a phone call



When two phones are connected at the same time, if an incoming call is received on the second phone while you are talking on the first phone, the dial confirmation screen for the second phone will be displayed.

1. Touch  to answer the call.
 - If you touch  while getting a call waiting, you can switch to the talking person.
 - Touch  to reject the call.
2. Touch  to end the call.

Minimizing the dial confirmation screen

The dial confirmation screen cannot be minimized on the AV operation screen.

AV sources cannot be selected even if the dial confirmation screen is minimized while talking on the phone or receiving an incoming call.

1. Touch 
 - Touch  to display the dial confirmation screen again

Notes for hands-free phoning

General notes

- Connection to all cellular phones featuring Bluetooth wireless technology is not guaranteed.
- The line-of-sight distance between this product and your cellular phone must be 10 meters or less when sending and receiving voice and data via Bluetooth technology.
- With some cellular phones, the ring sound may not be output from the speakers.
- If private mode is selected on the cellular phone, hands-free phoning may be disabled.

Registration and connection

- Cellular phone operations vary depending on the type of cellular phone. Refer to the instruction manual that came with your cellular phone for detailed instructions.
- When phone book transfer does not work, disconnect your phone and then perform pairing again from your phone to this product.

Making and receiving calls

- You may hear a noise in the following situations:
 - When you answer the phone using the button on the phone.
 - When the person on the other end of the line hangs up the phone.
- If the person on the other end of the line cannot hear the conversation due to an echo, decrease the volume level for hands-free phoning.
- With some cellular phones, even after you press the accept button on the cellular phone when a call comes in, handsfree phoning may not be performed.
- The registered name will appear if the phone number is already registered in the phone book. When one phone number is registered under different names, only the phone number will be displayed.

The received call and the dialed number histories

- You cannot make a call to the entry of an unknown user (no phone number) in the received call history.
- If calls are made by operating your cellular phone, no history data will be recorded in this product.

Phone book transfers

- If there are more than 1 000 phone book entries on your cellular phone, not all entries may download completely.
- Depending on the phone, this product may not display the phone book correctly.

- If the phone book in the phone contains image data, the phone book may not be transferred correctly.
- Depending on the cellular phone, phone book transfer may not be available.



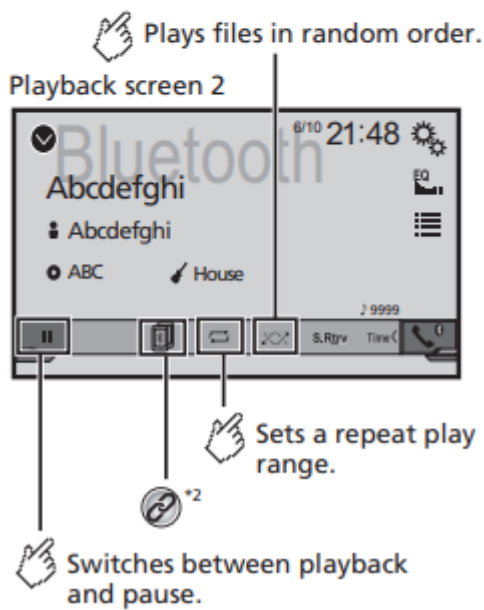
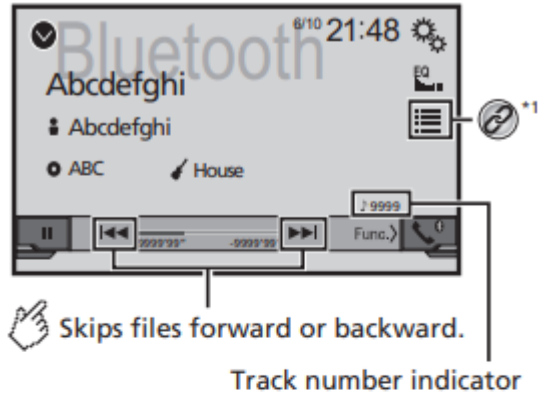

Bluetooth audio player

Playback screen 1



- *1 Selects a file from the list.
➤ Refer to *Selecting files from the file name list* on page 32
- *2 Switches among the Bluetooth devices when the devices are connected to this product via Bluetooth.
➤ Refer to *Switching the connected Bluetooth device* on page 13

- Depending on the Bluetooth audio player connected to this product, the available operations with this product may be limited to the following two levels:
- A2DP (Advanced Audio Distribution Profile): Only playing back songs on your audio player is possible.

- A2DP and AVRCP (Audio/Video Remote Control Profile): Playing back, pausing, selecting songs, etc., are possible.
- By pressing the  or  button, you can also skip files forward or backward.
- By pressing and hold the  or  button, you can also perform fast reverse or fast forward.
- Depending on the Bluetooth device connected to this product, the available operations with this product may be limited or differ from the descriptions in this manual.
- While you are listening to songs on your Bluetooth device, please refrain from operating the phone function as much as possible. If you try operating, the signal may cause noise for song playback.
- When you are talking on the Bluetooth device connected to this product via Bluetooth, it may pause playback.

Starting procedure

Before using the Bluetooth audio player, register and connect the device to this product. Refer to Registering your Bluetooth devices on page 12

1. Pull out the connecting cable for using AppRadioOne.

You cannot use Bluetooth device when the connecting cable for using AppRadioOne is connected.

2. Display the “System” setting screen.

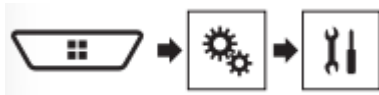

3. Touch [AV Source Settings].
4. Confirm that “Bluetooth Audio” is turned on.
5. Display the “AV source selection” screen.



6. Touch [Bluetooth Audio] on the AV source selection screen.



Selecting files from the file name list

This function is available only when the AVRCP version of the Bluetooth device is 1.4 or higher.

1. Touch .
2. Touch a file or a folder on the list to play back.

System settings

Displaying the “System” setting screen

1. Press .
2. Touch , and then .

The “System” setting screen appears.

Setting Bluetooth audio source activation

The default setting is “On”.

1. Display the “System” setting screen. Refer to Displaying the “System” setting screen on page 39
2. Touch [AV Source Settings].
3. Touch [Bluetooth Audio] to switch “On” or “Off”.

Setting Spotify source activation

The default setting is “On”.

1. Display the “System” setting screen. Refer to Displaying the “System” setting screen on page 39
2. Touch [AV Source Settings].
3. Touch [Spotify] to switch “On” or “Off”.

Setting the ever scroll

When “Ever Scroll” is set to “On”, the recorded text information scrolls continuously in the display while the vehicle is stopped. The default setting is “Off”.

1. Display the “System” setting screen. Refer to Displaying the “System” setting screen on page 39
2. Touch [Ever Scroll] to switch “On” or “Off”.

Setting the beep tone

The default setting is “On”.

1. Display the “System” setting screen. Refer to Displaying the “System” setting screen on page 39
2. Touch [Beep Tone] to switch “On” or “Off”.

Setting the auto audio mix function

You can select whether or not to activate the auto audio mix function. If the auto audio mix function is activated, this product automatically switches between mixing or not mixing the AV source sound and the sound output from your iPhone or smartphone according to the mixing property, such as that of the mixed sound or solo sound of the foreground application on your iPhone or smartphone.

The default setting is “On”.

1. Display the “System” setting screen. Refer to Displaying the “System” setting screen on page 39
2. Touch [Auto Mix] to switch “On” or “Off”.

Setting AppRadioOne Sound

You can set where the sound for AppRadioOne is output when it is used with an Android device.

1. Display the “System” setting screen. Refer to Displaying the “System” setting screen on page 39
2. Touch [Input/Output settings].
3. Touch [AppRadioOne Sound].
4. Touch the following settings.

AVH (default):

The sound is output from the speakers of this unit.

Smartphone:

The sound is output from the speakers of the Android device.

- With an iPhone, the sound is always output from the speakers of this unit.

Setting the rear view camera

A separately sold rear view camera (e.g. ND-BC8) is required for utilizing the rear view camera function. (For details, consult your dealer.)

Rear view camera

This product features a function that automatically switches to the full-screen image of the rear view camera installed on your vehicle, when the shift lever is in the REVERSE (R) position. Camera View mode also allows you to check what is behind you while driving.

Camera for Camera View mode

Camera View can be displayed at all times. Please note that with this setting, the camera image is not resized to fit, and that a portion of what is seen by the camera is not viewable.

To display the camera image, touch [Camera View] on the “AV source selection” screen. Refer to Source on the AV source selection screen on page 11

- To set the rear view camera as the camera for Camera View mode, set “Back Camera Input” to “On”. Refer to Setting rear view camera activation on page 39
- When using the 2nd camera, set “AV Input” to “Camera”. Refer to Starting procedure (for camera) on page 37
- When the camera view of both the rear view camera and 2nd camera are available, the key to switch the display appears. Touch this key to switch the display between the rear view image and 2nd camera image.

Setting the demo mode

The default setting is “On”.

1. Display the “System” setting screen. Refer to Displaying the “System” setting screen on page 39
2. Touch [Demo Mode] to switch “On” or “Off”.

Selecting the system language

- If the embedded language and the selected language setting are not the same, text information may not display properly.
 - Some characters may not be displayed properly.
1. Display the “System” setting screen. Refer to Displaying the “System” setting screen on page 39
 2. Touch [System Language].
 3. Touch the language.

After the language is selected, the previous screen returns.

Setting the keyboard language with the application for iPhone

You can use the keyboard in AppRadioOne by setting the language of the keyboard for iPhone.

- This function is only available in AppRadioOne on the iPhone.
1. Display the “System” setting screen. Refer to Displaying the “System” setting screen on page 39
 2. Touch [Keyboard].
 3. Touch the language.

After the language is selected, the previous screen returns

Adjusting the picture

You can adjust the picture for each source and rear view camera.

CAUTION For safety reasons, you cannot use some of these functions while your vehicle is in motion. To enable these functions, you must stop in a safe place and apply the parking brake.

1. Display the screen you wish to adjust.
2. Display the “System” setting screen. Refer to Displaying the “System” setting screen on page 39
3. Touch [Picture Adjustment].
4. Touch the item to select the function to be adjusted.

Brightness:

Adjusts the black intensity. (–24 to +24)

Contrast:

Adjusts the contrast. (–24 to +24)

Color:

Adjusts the color saturation. (–24 to +24)

Hue:





Adjusts the tone of color (which color is emphasized, red or green). (–24 to +24)

Dimmer:

Adjusts the brightness of the display. (+1 to +48)

Temperature:

Adjusts the color temperature, resulting in a better white balance. (–3 to +3)

- With some pictures, you cannot adjust Hue and Color.
 - When you touch [Rear View] or [2nd Camera], the mode changes to the selected camera mode. By touching [Source], [Navi] or [Apps], you can return to the selected mode.
5. Touch , , ,  to adjust.
- The adjustments of “Brightness”, “Contrast” and “Dimmer” are stored separately when your vehicle’s headlights are off (daytime) and on (nighttime).
 - “Brightness” and “Contrast” are switched automatically depending on whether the vehicle’s headlights are on or off.
 - “Dimmer” can be changed the setting or the time to switch it to on or off. Refer to Setting the dimmer on page 40
 - The picture adjustment may not be available with some rear view cameras.

- The setting contents can be memorized separately

Displaying the firmware version

1. Display the “System” setting screen. Refer to Displaying the “System” setting screen on page 39
2. Touch [System Information].
3. Touch [Firmware Information]. The “Firmware Information” screen appears.

Displaying the open source licenses

1. Display the “System” setting screen. Refer to Displaying the “System” setting screen on page 39
2. Touch [System Information].
3. Touch [License]. The open source licenses of the functions that this product is equipped with appear

Troubleshooting

If you have problems operating this product, refer to this section. The most common problems are listed below, along with likely causes and solutions. If a solution to your problem cannot be found here, contact your dealer or the nearest authorized Pioneer service facility.

Common problems

A black screen is displayed, and operation is not possible using the touch panel keys.

Power OFF” mode is on.

Press any button on this product to release the mode.

Problems with the AV screen

CD or DVD playback is not possible.

The disc is inserted upside down.

Insert the disc with the label upward.

The disc is dirty.

Clean the disc.

The disc is cracked or otherwise damaged.

Insert a normal, round disc.

The files on the disc are in an irregular file format.

Check the file format.

The disc format cannot be played back.

Replace the disc.

The loaded disc is a type this product cannot play.

Check what type of disc it is.

The screen is covered by a caution message and the video cannot be shown.

The parking brake lead is not connected or applied.

Connect the parking brake lead correctly, and apply the parking brake.

The parking brake interlock is activated.

Park your vehicle in a safe place and apply the parking brake.

No video output from the connected equipment.

The “AV Input” or “AUX Input” setting is incorrect.

Correct the settings.

The audio or video skips.

This product is not firmly secured.

Secure this product firmly.

No sounds are produced. The volume level will not rise.

Cables are not connected correctly.

Connect the cables correctly.

The system is performing still, slow motion, or frame-byframe playback with DVD-Video.

There is no sound during still, slow motion, or frame-byframe playback with DVD-Video.

The system is paused or performing, fast reverse or forward during the disc playback.

For the media other than music CD (CD-DA), there is no sound on fast reverse or forward.

The icon  is displayed, and operation is impossible.

The operation is not compatible with the video configuration.

This operation is not possible. (For example, the DVD playing does not feature that angle, audio system, subtitle language, etc.)

Random playback in Music Browse mode is released in the USB storage device.

Random playback in Music Browse mode is canceled after the ignition switch is turned off (ACC off).

Switch to Music Browse mode again and turn on random playback.

The picture stops (pauses) and this product cannot be operated.

The reading of data is impossible during disc playback.

Stop playback once, then restart.

The picture is stretched, with an incorrect aspect ratio.

The aspect setting is incorrect for the display.

Select the appropriate setting for that image.

A parental lock message is displayed and DVD playback is not possible.

The parental lock is on.

Turn the parental lock off or change the level.

The parental lock for DVD playback cannot be canceled.

The code number is incorrect.

Input the correct code number.

Playback is not with the audio language and subtitle language settings selected in “DVD/DivX Setup”.

The DVD playing does not feature dialog or subtitles in the language selected in “DVD/DivX Setup”.

Switching to a selected language is not possible if the language selected in “DVD/DivX Setup” is not recorded on the disc.

The picture is extremely unclear/distorted and dark during playback.

The disc features a signal to prohibit copying. (Some discs may have this.)

Since this product is compatible with the copy guard analog copy protect system, the picture may suffer from horizontal stripes or other imperfections when a disc with that kind of protection signal is viewed on some displays. This is not a malfunction.

iPod cannot be operated.

The iPod is frozen.

Reconnect the iPod with the USB interface cable for iPod / iPhone.

Update the iPod software version.

An error has occurred.

Reconnect the iPod with the USB interface cable for iPod / iPhone.

Park your vehicle in a safe place, and turn off the engine. Turn the ignition key back to off (ACC OFF). Then restart the engine, and turn the power to this product back on.

Update the iPod software version.

Cables are not connected correctly.

Connect the cables correctly.

Sound from the iPod cannot be heard.

The audio output direction may switch automatically when the Bluetooth and USB connections are used at the same time.

Use the iPod to change the audio output direction.

Problems with the phone screen

Dialing is impossible because the touch panel keys for dialing are inactive.

Your phone is out of range for service.

Retry after re-entering the range for service.

The connection between the cellular phone and this product cannot be established now.

Perform the connection process.

Of the two cellular phones connected to this product at the same time, if the first phone is dialing, ringing or a call is in progress, dialing cannot be performed on the second phone.

When the operation on the first of the two cellular phones is completed, use the switch devices key to switch to the second phone and then dial.

Problems with the Application screen

A black screen is displayed.

While operating an application, the application was ended on the smartphone side.

Press  to display the Top menu screen.

The smartphone OS may be awaiting screen operation.

Stop the vehicle in a safe place and check the screen on the smartphone.

The screen is displayed, but operation does not work at all.

An error has occurred.

Park your vehicle in a safe place, and then turn off the ignition switch (ACC OFF). Subsequently, turn the ignition switch to on (ACC ON) again.

When an Android device is connected, disconnect the Bluetooth connection from this product and then reconnect it.

The smartphone was not charged.

Charging stopped because the temperature of the smartphone rose due to prolonged use of the smartphone during charging.

Disconnect the smartphone from the cable, and wait until the smartphone cools down.

More battery power was consumed than was gained from charging.

This problem may be resolved by stopping any unnecessary services on the smartphone.

Sound from AppRadioOne of the Android device cannot be heard from the speakers of this unit.

Depending on the Android device, the sound from AppRadioOne may not be output from the speakers of this unit.

Switch to “ Smartphone” in the “AppRadioOne Sound” settings.(Refer to 39)

Error messages

When problems occur with this product, an error message appears on the display. Refer to the table below to identify the problem, then take the suggested corrective action. If the error persists, record the error message and contact your dealer or your nearest Pioneer service center.

Common

AMP Error

This product fails to operate or the speaker connection is incorrect; the protective circuit is activated.

Check the speaker connection. If the message fails to disappear even after the engine is switched off/on, contact your dealer or an authorized Pioneer Service Station for assistance.

Pandora

Error-19

Communication failed.

Disconnect the cable from the iPod. Once the iPod's main menu is displayed, reconnect the iPod and reset it.

Skip limit reached.

Skip limit reached.

Do not exceed the skip limit.

Pandora limits the total number of skips per hour.

Check Device

You are not logged in to the Pandora application.

Please log in to the Pandora application.

Incompatible USB

The connected USB storage device is not supported by this product.

Disconnect your device and replace it with a compatible USB storage device.

Check USB

The USB connector or USB cable has short-circuited.

Check that the USB connector or USB cable is not caught in something or damaged.

The connected USB storage device consumes more than maximum allowable current.

Disconnect the USB storage device and do not use it. Turn the ignition switch to OFF, then to ACC or ON and then connect a compliant USB storage device.

Cannot play music due to licensing restrictions.

The Pandora application is accessed/relocated from outside the licensing region.

Access Pandora from within the licensing region.

Spotify

Skip limit reached.

Skip limit reached.

Do not exceed the skip limit.

Spotify limits the total number of skips per hour.

Check USB

The USB connector or USB cable has short-circuited.

Check that the USB connector or USB cable is not caught in something or damaged.

The connected USB storage device consumes more than maximum allowable current.

Disconnect the USB storage device and do not use it. Turn the ignition switch to OFF, then to ACC or ON and then connect a compliant USB storage device.

SiriusXM Satellite Radio

Check Antenna

The antenna connection is incorrect.

Check the antenna connection. If the message fails to disappear even after the engine is switched off/on, contact your dealer or the nearest authorized Pioneer service center for assistance.

Check Tuner

The SiriusXM Connect Vehicle Tuner connection is incorrect.

Check the tuner connection and battery voltage. If the message fails to disappear even after the engine is switched off/on, contact your dealer or the nearest authorized Pioneer service center for assistance.

No Signal

The SiriusXM Connect Vehicle Tuner is having difficulty receiving the SiriusXM satellite signal.

Verify that your vehicle is outdoors with a clear view of the southern sky.

Verify that the SiriusXM magnetic mount antenna is mounted on a metal surface on the outside of the vehicle.

Move the SiriusXM antenna away from any obstructions.

No Content

TuneScan is not available.

Perform the operation with another preset channel.

Channel Not Available

The channel that you have requested is not a valid SiriusXM channel.

Check the SiriusXM channel lineup.

Subscription Updated Press Enter to Continue

This product has detected a change in your SiriusXM subscription status.

Touch [Enter] to clear the message.

Channel Not Subscribed. Call SiriusXM to Subscribe.

The channel that you have requested is not included in your SiriusXM subscription package.

Check the content of your SiriusXM subscription package.

Channel Locked Please Enter the Lock Code

Locked by the radio Parental Control feature.

Release the channel lock.

Artist Unavailable

The alert memo function is not available.

Perform the operation with another channel.

Song Unavailable

The alert memo function is not available.

Perform the operation with another channel.

Team Unavailable

The alert memo function is not available.

Perform the operation with another channel.

Alert Memory Full You can manage alert memory in the alert list

The memory is full.

Clear the alert list.

Memory Full

The memory has become full while playback was paused.

Resume playback.

Memory Nearly Full

The memory has become nearly full while playback was paused.

Resume playback.

Tune Mix advisory

There are no qualified TuneMix channels in this band.

Requires two or more qualified music channels to be stored as presets in the current band.

Disc

Error-02-XX/FF-FF

The disc is dirty.

Clean the disc.

The disc is scratched.

Replace the disc.

The disc is loaded upside down.

Check that the disc is loaded correctly.

There is an electrical or mechanical error.

Press the RESET button.

Different Region Disc

The disc does not have the same region number as this product.

Replace the DVD with one bearing the correct region number.

Unplayable Disc

This type of disc cannot be played on this product.

Replace the disc with one that can be played on this product.

Unplayable File

This type of file cannot be played on this product.

Select a file that can be played.

Skipped

The inserted disc contains DRM protected files.

The protected files are skipped.

Protect

All the files on the inserted disc are embedded with DRM.

Replace the disc.

TEMP

The temperature of this product is outside the normal operating range.

Wait until this product returns to a temperature within the normal operating limits.

This DivX rental has expired.

The inserted disc contains expired DivX VOD content.

Select a file that can be played.

Unable to write to flash memory.

The playback history for VOD contents cannot be saved for some reason.

Retry.

If the message appears frequently, consult your dealer.

Your device is not authorized to play this DivX protected video.

This product's DivX registration code has not been authorized by the DivX VOD contents provider.

Register this product to the DivX VOD contents provider.

Video frame rate not supported

DivX file's frame rate is more than 30 fps .

Select a file that can be played.

Audio Format not supported

This type of file is not supported on this product.

Select a file that can be played.

USB storage device

Error-02-9X/-DX

Communication failed.

- Turn the ignition switch OFF and back ON.
- Disconnect the USB storage device.
- Change to a different source. Then, return to the USB storage device.

Unplayable File

This type of file cannot be played on this product.

Select a file that can be played.

Security for the connected USB storage device is enabled.

Follow the USB storage device instructions to disable security.

Skipped

The connected USB storage device contains DRM protected files.

The protected files are skipped.

Protect

All the files on the connected USB storage device are embedded with DRM.

Replace the USB storage device.

Incompatible USB

The connected USB storage device is not supported by this product.

Disconnect your device and replace it with a compatible USB storage device.

Check USB

The USB connector or USB cable is short-circuited.

Check that the USB connector or USB cable is not caught in something or damaged.

The connected USB storage device consumes more than maximum allowable current.

Disconnect the USB storage device and do not use it. Turn the ignition switch to OFF, then to ACC or ON and then connect a compliant USB storage device.

HUB Error

The connected USB hub is not supported by this product.

Directly connect the USB storage device to this product.

No Response

This product cannot recognize the connected USB storage device.

Disconnect the device and replace it with another USB storage device.

**USB was disconnected for device protection. Do not reinsert this USB memory into the unit.
Please restart the unit.**

The USB connector or USB cable is short-circuited.

Check that the USB connector or USB cable is not caught in something or damaged.

The connected USB storage device consumes more than maximum allowable current.

Disconnect the USB storage device and do not use it. Turn the ignition switch to OFF, then to ACC or ON and then connect a compliant USB storage device.

The USB interface cable for iPod / iPhone is short-circuited.

Confirm that the USB interface cable for iPod / iPhone or USB cable is not caught in something or damaged.

Audio Format not supported

This type of file is not supported on this product.

Select a file that can be played.

iPod

Error-02-6X/-9X/-DX

iPod failure.

Disconnect the cable from the iPod. Once the iPod's main menu is displayed, reconnect the iPod and reset it.

Error-02-67

The iPod firmware version is old.

Update the iPod version.

iTunes tagging

Error-8D

Built-in FLASH ROM encountered an error.

Turn the ignition switch to OFF and then to ON.

Tag store failed.

Tag information cannot be stored in this product.

Try again.

Already stored.

This tag information is already stored in memory.

Tag information can only be saved once for any given song. Tag information cannot be saved for the same song more than once.

Memory full. Connect iPod.

The tag information is successfully stored. The flash memory of this product has become full.

The tag information on this product is transferred to the iPod automatically when an iPod is connected.

Memory full. Tags not stored. Connect iPod.

This product's flash memory used as the temporary storage area is full.

The tag information on this product is transferred to the iPod automatically when an iPod is connected.

iPod full. Tags not transferred.

Memory used for tag information on the iPod is full.

Sync the iPod with iTunes and clean up the tagged playlist.

Tag transfer failed. Reconnect your iPod.

This product's tag information cannot transfer to the iPod.

Check the iPod and try again.

Bluetooth

Error-10

The power failed for the Bluetooth module of this product.

Turn the ignition switch to OFF and then to ON. If the error message is still displayed after performing the above action, please contact your dealer or an authorized Pioneer Service Station.

Handling and care of discs

Some basic precautions are necessary when handling your discs.

Built-in drive and care

- Use only conventional, fully circular discs. Do not use shaped discs.
- Do not use cracked, chipped, warped, or otherwise damaged discs as they may damage the built-in drive.
- Use 12-cm discs. Do not use 8-cm discs or an adapter for 8-cm discs.
- When using discs that can be printed on label surfaces, check the instructions and the warnings of the discs. Depending on the discs, inserting and ejecting may not be possible. Using such discs may result in damage to this equipment.

- Do not attach labels, write on or apply chemicals to the surface of the discs.
- Do not attach commercially available labels or other materials to the discs.
- To clean a disc, wipe it with a soft cloth, moving outward from the center.
- Condensation may temporarily impair the built-in drive's performance.
- Playback of discs may not be possible because of disc characteristics, disc format, recorded application, playback environment, storage conditions and so on.
- Road shocks may interrupt disc playback.
- Read the precautions for discs before using them.

Ambient conditions for playing a disc

- At extremely high temperatures, a temperature cutout protects this product by switching it off automatically.
- Despite our careful design of the product, small scratches that do not affect actual operation may appear on the disc surface as a result of mechanical wear, ambient conditions for use or handling of the disc. This is not a sign of the malfunction of this product. Consider it to be normal wear and tear.

Playable discs

DVD-Video



-  is a trademark of DVD Format/Logo Licensing Corporation.
- It is not possible to play DVD-Audio discs. This DVD drive may not be able to play all discs bearing the marks shown above.

CD



AVCHD recorded discs

This unit is not compatible with discs recorded in AVCHD (Advanced Video Codec High Definition) format. Do not insert AVCHD discs. If inserted, the disc may not be ejected.

Playing DualDisc

- DualDiscs are two-sided discs that have a recordable CD for audio on one side and a recordable DVD for video on the other.

- Playback of the DVD side is possible with this product. However, since the CD side of DualDiscs is not physically compatible with the general CD standard, it may not be possible to play the CD side with this product.
- Frequent loading and ejecting of a DualDisc may result in scratches to the disc.
- Serious scratches can lead to playback problems on this product. In some cases, a DualDisc may become stuck in the disc-loading slot and will not eject. To prevent this, we recommend you refrain from using DualDisc with this product.
- Please refer to the manufacturer for more detailed information about DualDiscs.

Dolby Digital

This product will down-mix Dolby Digital signals internally and the sound will be output in stereo.

- Manufactured under license from Dolby Laboratories. Dolby, Dolby Audio and the double-D symbol are trademarks of Dolby Laboratories.



Detailed information for playable media

Compatibility

Common notes about disc compatibility

- Certain functions of this product may not be available for some discs.
- Compatibility with all discs is not guaranteed.
- It is not possible to playback DVD-ROM/DVD-RAM discs.
- Playback of discs may become impossible with direct exposure to sunlight, high temperatures, or depending on the storage conditions in the vehicle.

DVD-Video discs

- DVD-Video discs that have incompatible region numbers cannot be played on this DVD drive. The region number of the player can be found on this product's chassis.

DVD-R/DVD-RW/DVD-R SL (Single Layer)/DVD-R DL (Dual Layer) discs

- Unfinalized discs which have been recorded with the Video format (video mode) cannot be played back.
- Discs which have been recorded with the Video Recording format (VR mode) cannot be played back.

- DVD-R DL (Dual Layer) discs which have been recorded with Layer Jump recording cannot be played back.
- For detailed information about recording mode, please contact the manufacturer of media, recorders, or writing software.

CD-R/CD-RW discs

- Unfinalized discs cannot be played back.
- It may not be possible to playback CD-R/CD-RW discs recorded on a music CD recorder or a computer because of disc characteristics, scratches or dirt on the disc, or dirt, scratches or condensation on the lens of the built-in drive.
- Playback of discs recorded on a computer may not be possible, depending on the recording device, writing software, their settings, and other environmental factors.
- Please record with the correct format. (For details, please contact manufacturer of media, recorders, or writing software.)
- Titles and other text information recorded on a CD-R/CD-RW disc may not be displayed by this product (in the case of audio data (CD-DA)).
- Read the precautions with CD-R/CD-RW discs before using them.

Common notes about the USB storage device

- Do not leave the USB storage device in any location with high temperatures.
- Depending on the kind of the USB storage device you use, this product may not recognize the storage device or files may not be played back properly.
- The text information of some audio and video files may not be correctly displayed.
- File extensions must be used properly.
- There may be a slight delay when starting playback of files on an USB storage device with complex folder hierarchies.
- Operations may vary depending on the kind of an USB storage device.
- It may not be possible to play some music files from USB because of file characteristics, file format, recorded application, playback environment, storage conditions, and so on.

USB storage device compatibility

For details about USB storage device compatibility with this product, refer to Specifications on page 66.

- Protocol: bulk
- You cannot connect a USB storage device to this product via a USB hub.
- Partitioned USB storage device is not compatible with this product.

- Firmly secure the USB storage device when driving. Do not let the USB storage device fall onto the floor, where it may become jammed under the brake or gas pedal.
- There may be a slight delay when starting playback of audio files encoded with image data.
- Some USB storage devices connected to this product may generate noise on the radio.
- Do not connect anything other than the USB storage device.

The sequence of audio files on USB storage device

For USB storage device, the sequence is different from that of USB storage device.

Handling guidelines and supplemental information

- This product is not compatible with the Multi Media Card (MMC).
- Copyright protected files cannot be played back.

Common notes about DivX files

Notes specific to DivX files

- Only DivX files downloaded from DivX partner sites are guaranteed for proper operation. Unauthorized DivX files may not operate properly.
- DRM rental files cannot be operated until playing back is started.
- This product corresponds to a DivX file display of up to 1 590 minutes 43 seconds. Search operations beyond this time limit are prohibited.
- DivX VOD file playback requires supplying the ID code of this product to the DivX VOD provider. Regarding the ID code, refer to Displaying your DivX VOD registration code on page 47.
- For details on the DivX video versions that can be played on this product, refer to Specifications on page 66.

DivX subtitle files

- Srt format subtitle files with the extension “.srt” can be used.
- Only one subtitle file can be used for each DivX file. Multiple subtitle files cannot be associated.
- Subtitle files that are named with the same character string as the DivX file before the extension are associated with the DivX file. The character strings before the extension must be exactly the same. However, if there is only one DivX file and one subtitle file in a single folder, the files are associated even if the file names are not the same.
- The subtitle file must be stored in the same folder as the DivX file.

- Up to 255 subtitle files may be used. Any more subtitle files will not be recognized.
- Up to 64 characters can be used for the name of the subtitle file, including the extension. If more than 64 characters are used for the file name, the subtitle file may not be recognized.
- The character code for the subtitle file should comply with ISO-8859-1. Using characters other than ISO-8859-1 may cause the characters to be displayed incorrectly.
- The subtitles may not be displayed correctly if the displayed characters in the subtitle file include control code.
- For materials that use a high transfer rate, the subtitles and video may not be completely synchronized.
- If multiple subtitles are programmed to display within a very short time frame, such as 0.1 seconds, the subtitles may not be displayed at the correct time.

Warning

This content is compiled from multiple sources and is provided for reference purposes only. It may not be complete or fully applicable to all situations. If you are unable to resolve your issue, please contact the product manufacturer or an authorized service provider for official support.