

## Preparing

### Wall Mounting Bracket

(Depending on model)

Make sure to use screws and wall mount bracket that meet the VESA standard. Standard dimensions for the wall mount kits are described in the following table.

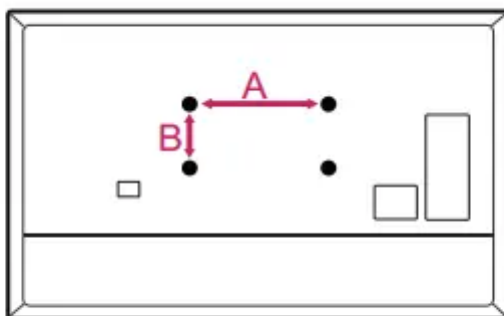

<b>Model</b>	<b>43/50NAN079*</b> <b>49NAN080*</b> <b>49NAN081*</b> <b>49NAN086*</b>	<b>55NAN079*</b> <b>55NAN080*</b> <b>55NAN081*</b> <b>55NAN086*</b> <b>55NAN090*</b> <b>55NAN091*</b>
<b>VESA (A x B) (mm)</b>	200 x 200	300 x 300
<b>Standard screw</b>	M6	M6
<b>Number of screws</b>	4	4
<b>Wall mount bracket</b>	LSW240B MSW240	OLW480B MSW240
<b>Model</b>	<b>65NAN079*</b> <b>65NAN080*</b> <b>65NAN081*</b> <b>65NAN086*</b> <b>65NAN090*</b> <b>65NAN091*</b>	<b>75NAN079*</b> <b>75/86NAN090*</b> <b>75/86NAN091*</b>
<b>VESA (A x B) (mm)</b>	300 x 300	600 x 400
<b>Standard screw</b>	M6	M8
<b>Number of screws</b>	4	4
<b>Wall mount bracket</b>	OLW480B	LSW640B

### Lifting and moving the TV

Please note the following advice to prevent the TV from being scratched or damaged and for safe transportation regardless of its type and size.

- It is recommended to move the TV in the box or packing material that the TV originally came in.
- Before moving or lifting the TV, disconnect the power cord and all cables.
- When holding the TV, the screen should face away from you to avoid damage.

- Hold the top and bottom of the TV frame firmly. Make sure not to hold the transparent part, speaker, or speaker grill area.

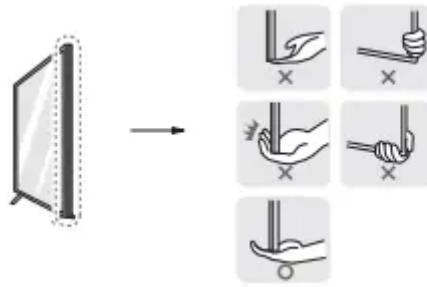

- When transporting a large TV, there should be at least 2 people.
- When transporting the TV by hand, hold the TV as shown in the following illustration.
- When transporting the TV, do not expose the TV to jolts or excessive vibration.
- When transporting the TV, keep the TV upright, never turn the TV on its side or tilt towards the left or right.
- Do not apply excessive pressure to cause flexing / bending of frame chassis as it may damage screen.
- When handling the TV, be careful not to damage the protruding buttons.
- Avoid touching the screen at all times, as this may result in damage to the screen.
- Do not place the product on the floor with its front facing down without padding. Failure to do so may result in damage to the screen.
- When attaching the stand to the TV set, place the screen facing down on a cushioned table or flat surface to protect the screen from scratches.

### **Mounting on a Table**

1. Lift and tilt the TV into its upright position on a table.
  - Leave a 10 cm (minimum) space from the wall for proper ventilation.

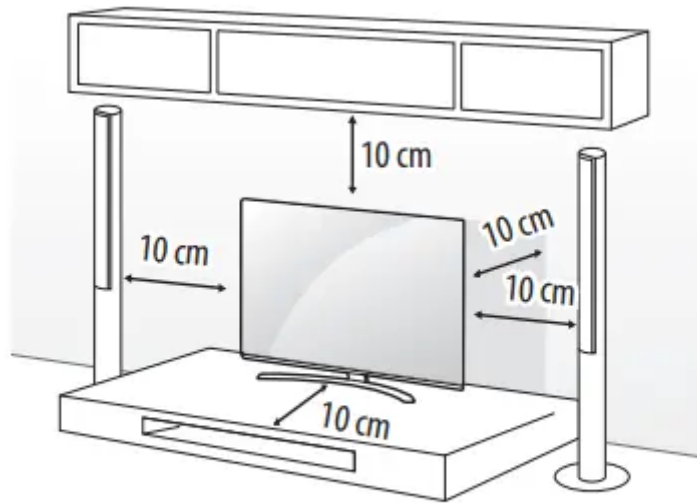

(Depending on model)

2. Connect the power cord to a wall outlet.

- Do not apply foreign substances (oils, lubricants, etc.) to the screw parts when assembling the product. (Doing so may damage the product.)
- If you install the TV on a stand, you need to take actions to prevent the product from overturning. Otherwise, the product may fall over, which may cause injury.
- Do not use any unapproved items to ensure the safety and lifespan of the product.
- Any damages or injuries by using unapproved items are not covered by the warranty.
- Make sure that the screws are fastened tightly. (If they are not fastened securely enough, the TV may tilt forward after being installed.)
- Do not fasten the screws with excessive force otherwise they may strip and become loose.

## Securing TV to the Wall

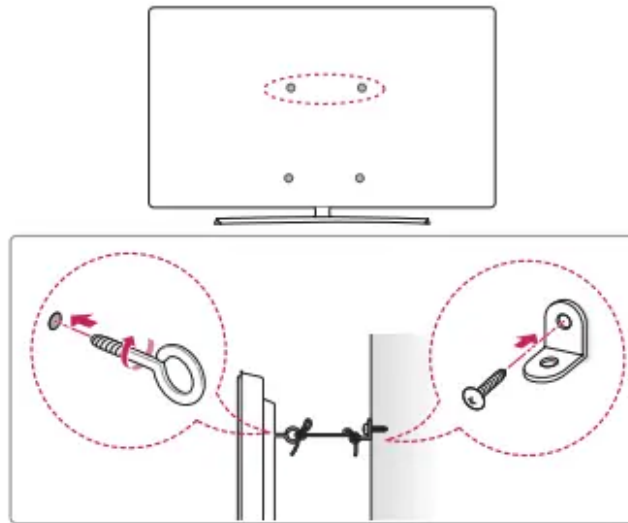

(Depending on model)

1. Insert and tighten the eye-bolts or TV brackets and bolts on the back of the TV.
  - If there are bolts inserted at the eye-bolts position, remove the bolts first.
2. Mount the wall brackets with the bolts to the wall. Match the location of the wall bracket and the eye-bolts on the rear of the TV.
3. Connect the eye-bolts and wall brackets tightly with a sturdy rope or cable. Make sure to keep the rope parallel to the flat surface.
  - Use a platform or cabinet that is strong and large enough to support the TV securely.
  - Brackets, bolts, and ropes are optional. You can obtain additional accessories from your local dealer.

## Mounting to the Wall

An optional wall mount can be used with your LG Television. Consult with your local dealer for a wall mount that supports the VESA standard used by your TV model. Carefully attach the wall mount bracket at the rear of the TV. Install the wall mount bracket on a solid wall perpendicular to the floor. If you are attaching the TV to other building materials, please contact qualified personnel to install the wall mount. Detailed instructions will be included with the wall mount. We recommend that you use an LG brand wall mount. The LG wall mount is easy to adjust or to connect the cables. When you do not use LG's wall mount bracket, use a wall mount bracket where the device is adequately secured to the wall with enough space to allow connectivity to external devices. If

you are using a non-adjustable mount, attach the mount to the wall. Attach the cables to the TV first, then attach the TV to the mount.

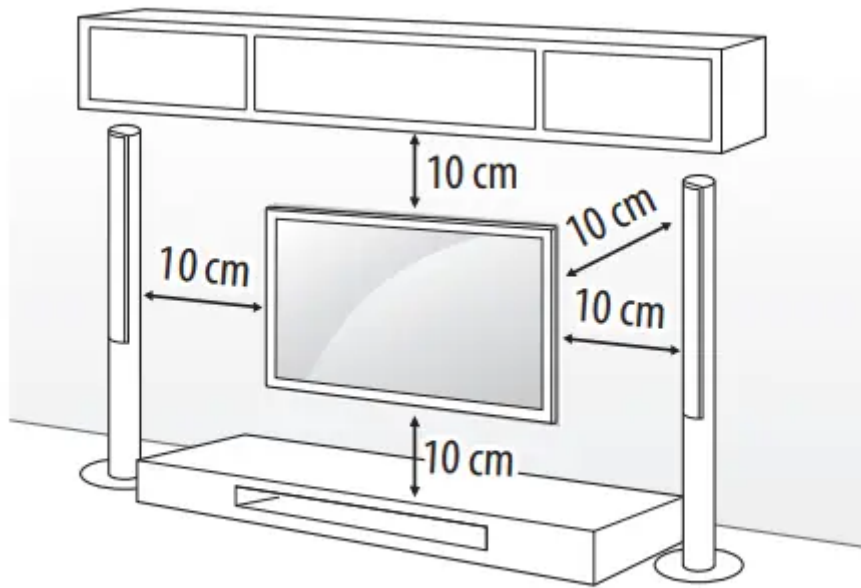

(Depending on model)

- Remove the stand before installing the TV on a wall mount by performing the stand attachment in reverse.
- For more information of screws and wall mount bracket, refer to the Separate Purchase.
- If you intend to mount the product to a wall, attach VESA standard mounting interface (optional parts) to the back of the product. When you install the set to use the wall mounting bracket (optional parts), fix it carefully so as not to drop.
- When mounting a TV on the wall, make sure not to install the TV by hanging the power and signal cables on the back of the TV.
- Do not install this product on a wall if it could be exposed to oil or oil mist. This may damage the product and cause it to fall.

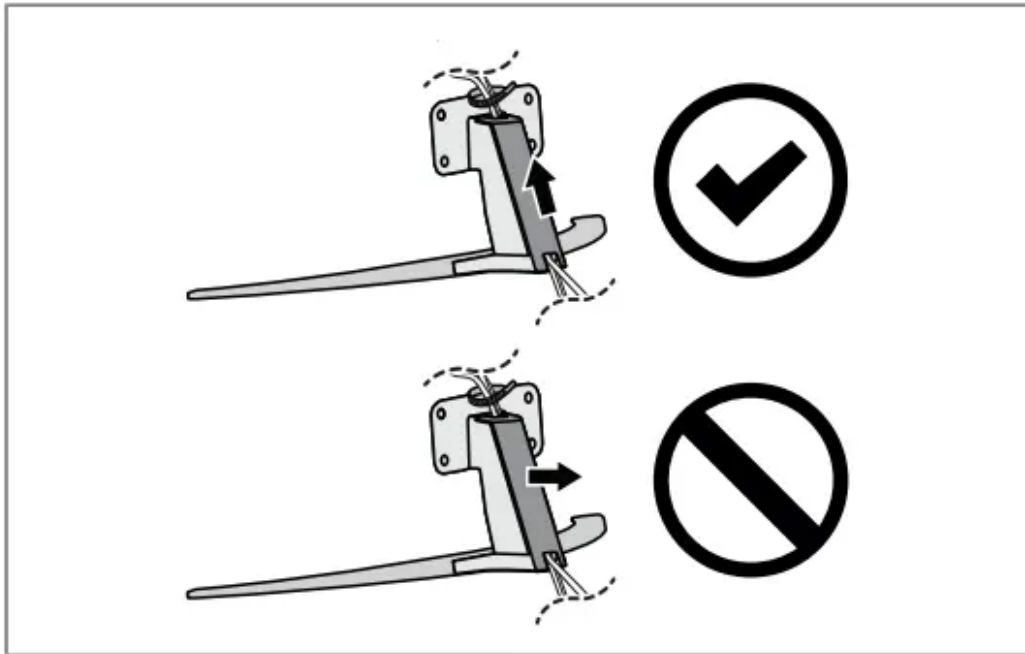

(Depending on model)

- Do not use a sharp object when you detached the cable cover. This could damage the cable or the cabinet. It may also cause personal harm. (Depending on model)
- When installing the wall mounting bracket, it is recommended to cover the stand hole using tape, in order to prevent the influx of dust and insects, (Depending upon model).

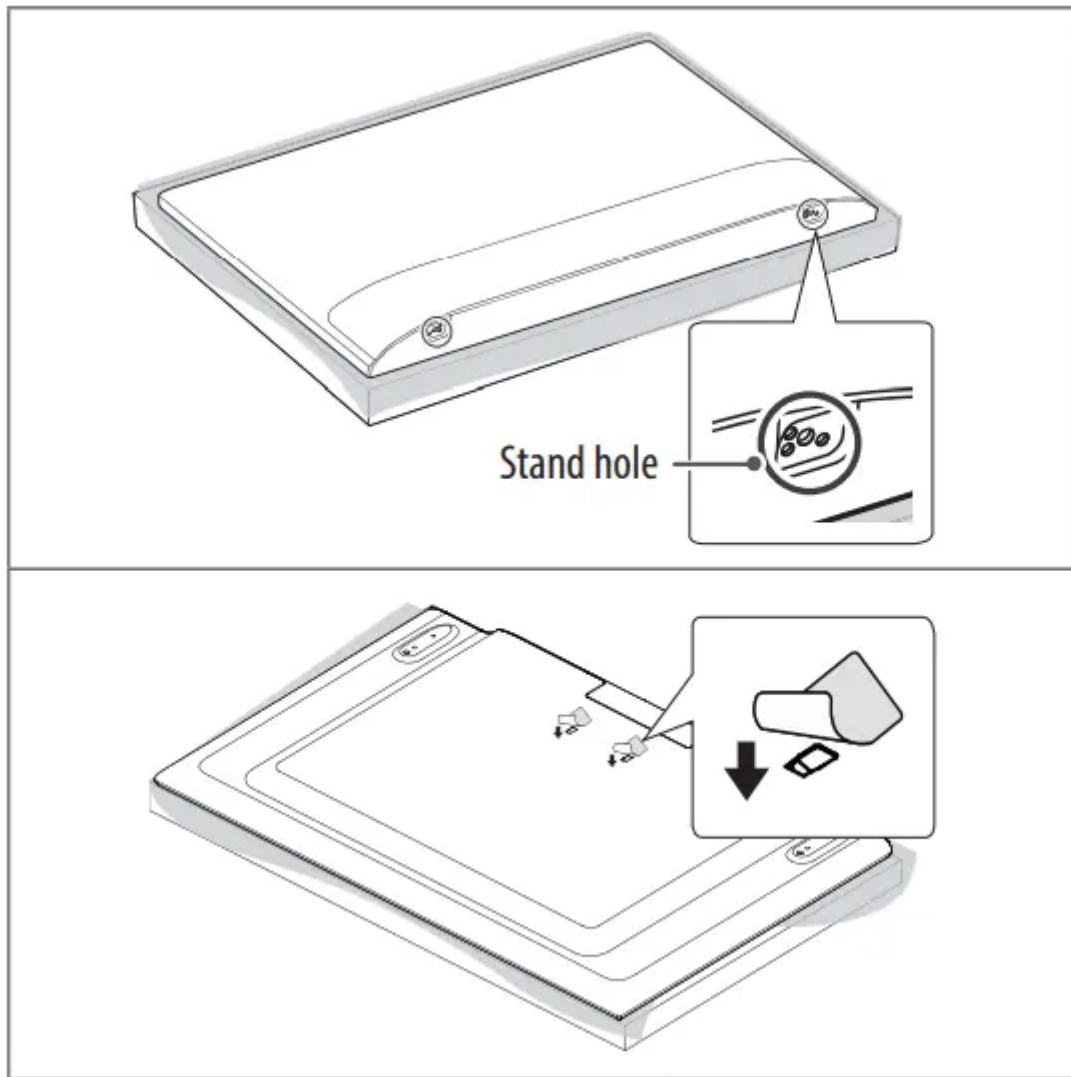

## Connections

Connect various external devices to the TV and switch input modes to select an external device. For more information of external device's connection, refer to the manual provided with each device.

### Antenna/Cable

Connect the TV to a wall antenna socket with an RF cable (75  $\Omega$ ).

- Use a signal splitter to use more than 2 TVs
- If the image quality is poor, install a signal amplifier properly to improve the image quality.
- If the image quality is poor with an antenna connected, try to realign the antenna in the correct direction.
- An antenna cable and converter are not supplied

- For a location that is not supported with ULTRA HD broadcasting, this TV cannot receive ULTRA HD broadcasts directly.

### Satellite dish

Connect the TV to a satellite dish to a satellite socket with a satellite RF cable (75 Ω). (Depending on model)

### CI module

View the encrypted (pay) services in digital TV mode. (Depending on model)

- Check if the CI module is inserted into the PCMCIA card slot in the right direction. If the module is not inserted properly, this can cause damage to the TV and the PCMCIA card slot.
- If the TV does not display any video and audio when CI+ CAM is connected, please contact to the Terrestrial/Cable/Satellite Service perator.

### Other connections

Connect your TV to external devices. For the best picture and audio quality, connect the external device and the TV with the HDMI cable. Some separate cable is not provided.



### HDMI

- When connecting the HDMI cable, the product and external devices should be turned off and unplugged.
- Supported HDMI Audio format (Depending on model):

True HD (48 kHz),

Dolby Digital / Dolby Digital Plus (32 kHz / 44.1 kHz / 48 kHz),

PCM (32 kHz / 44.1 kHz / 48 kHz / 96 kHz / 192 kHz)

-  →  → [Picture] → [Additional Settings] → [HDMI Ultra HD Deep Colour] (Only NANO79\*, NANO80\*, NANO81\*)

- On: Support 4K @ 50/60 Hz (4:4:4, 4:2:2, 4:2:0)

- Off : Support 4K @ 50/60 Hz (4:2:0)

(Except for NANO79\*, NANO80\*, NANO81\*)

- On: Support 4K @ 50/60 Hz (4:4:4, 4:2:2, 4:2:0)

<3, 4 port Only> 4K @ 100/120 Hz (4:4:4, 4:2:2, 4:2:0)

- Off : Support 4K @ 50/60 Hz (4:2:0)

- If the device connected to Input Port also supports Ultra HD Deep Colour, your picture may be clearer. However, if the device doesn't support it, it may not work properly. In that case, change the TV's [HDMI Ultra HD Deep Colour] setting to off.

## USB

- Some USB Hubs may not work. If a USB device connected using a USB Hub is not detected, connect it to the USB port on the TV directly

## External Devices

Available external devices are: Blu-ray player, HD receivers, DVD players, VCRs, audio systems, USB storage devices, PC, gaming devices, and other external devices.

- The external device connection may differ from the model.
- Connect external devices to the TV regardless of the order of the TV port.
- If you record a TV program on a Blu-ray/DVD recorder or VCR, make sure to connect the TV signal input cable to the TV through a DVD recorder or VCR. For more information of recording, refer to the manual provided with the connected device.
- Refer to the external equipment's manual for operating instructions.
- If you connect a gaming device to the TV, use the cable supplied with the gaming device.
- In PC mode, there may be noise associated with the resolution, vertical pattern, contrast or brightness. If noise is present, change the PC output to another resolution, change the refresh rate to another rate or adjust the brightness and contrast on the [Picture] menu until the picture is clear.
- In PC mode, some resolution settings may not work properly depending on the graphics card.
- If ULTRA HD content is played on your PC, video or audio may become disrupted intermittently depending on your PC's performance. (Depending on model)
- When connecting via a wired LAN, it is recommended to use a CAT cable. (Only when **LAN** port is provided.)

## Using Button

You can simply operate the TV functions, using the button.

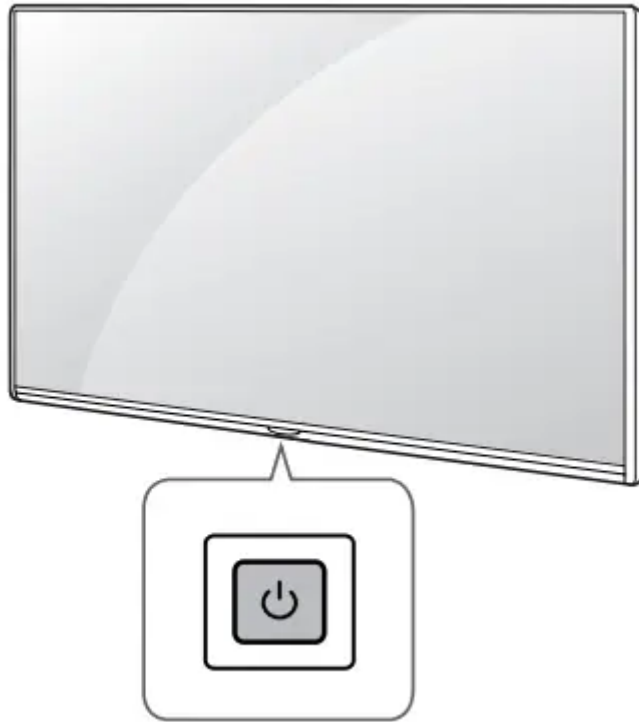

## Basic functions

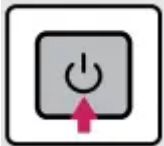
	<p><b>Power On (Press)</b> <b>Power Off ( 1 ) (Press and Hold) :</b> <b>Menu Control (Press 2) :</b> <b>Menu Selection (Press and Hold 3) :</b></p>
---	---

1. All running apps will close, and any recording in progress will stop. (Depending on country)
2. You can access and adjust the menu by pressing the button when TV is on.
3. You can use the function when you access menu control.

## Adjusting the menu

When the TV is turned on, press the  button one time. You can adjust the Menu items using the button



Turns the power off



Changes the input source.

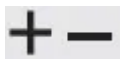

 Adjusts the volume level.

 Scrolls through the saved programmes.

## Using Remote Control

### Using Magic Remote Control

(Depending on model)

The descriptions in this manual are based on the buttons on the remote control. Please read this manual carefully and use the TV correctly. To replace batteries, open the battery cover, replace batteries (1.5 V AAA) matching the  and  ends to the label inside the compartment, and close the battery cover. Make sure to point the remote control toward the remote control sensor on the TV.

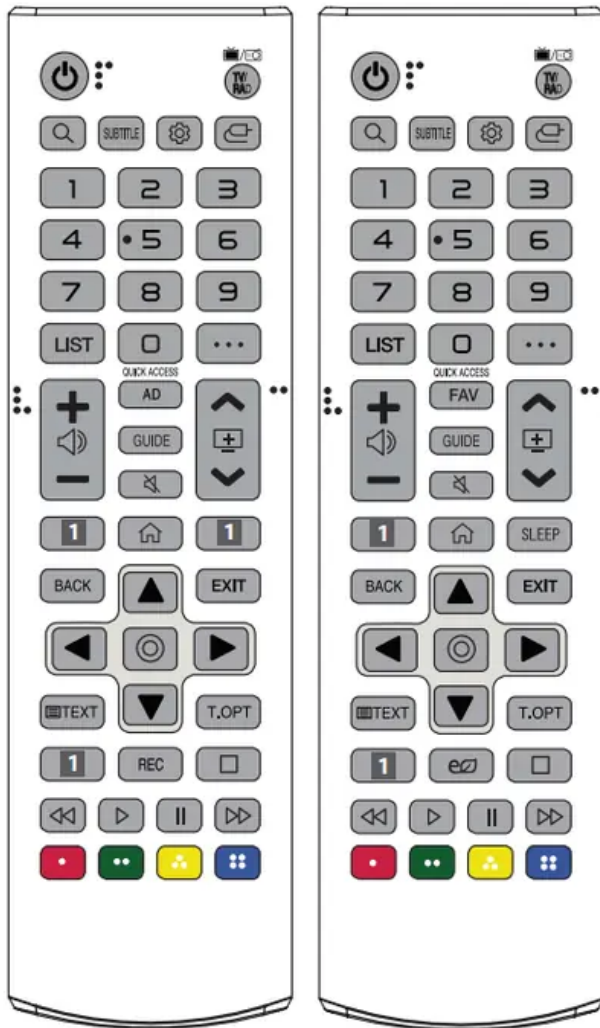

- (POWER)** Turns the TV on or off.
- TV/RAD** Selects Radio, TV and DTV programme.
- (SEARCH)** Check for recommended content. (Some recommended services may not be available in some countries.)  
Search for content such as TV programmes, movies and other videos, or perform a web search by entering text in the search bar.
- SUBTITLE** Recalls your preferred subtitle in digital mode.
- (Q. Settings)** Accesses the Quick Settings.
- (INPUT)** Changes the input source.
- Number buttons** Enters numbers.
- 9"** Accesses the [Quick Help].
- LIST** Accesses the saved programmes list.
- ...** **(MORE ACTIONS)** Displays more remote control functions.
- QUICK ACCESS"** Edits QUICK ACCESS.
  - QUICK ACCESS is a feature that allows you to enter a specified app or Live TV directly by pressing and holding the number buttons.
- + < > -** Adjusts the volume level.
- AD** Audio descriptions function will be enabled.
- FAV** Accesses your favorite channel list.
- GUIDE** Shows programme guide.
- (MUTE)** Mutes all sounds.
- (MUTE)** Accesses the [Accessibility] menu.
- (HOME)** Scrolls through the saved programmes.
- Streaming Service buttons** Connects to the Video Streaming Service.
- (HOME)** Accesses Home menu.
- (HOME)** Shows the previous history.
- SLEEP** Set the sleep timer.
- BACK** Returns to the previous level.
- EXIT** Clears on-screen displays and returns to TV viewing.
- Navigation buttons (up/down/left/right)** Scrolls through menus or options.
- (OK)** Selects menus or options and confirms your input.
- TEXT, T.OPT (Teletext buttons)** These buttons are used for teletext.
- REC** Starts to record and displays record menu. (Only Time Machine<sup>Ready</sup> supported model)
- (Energy Saving)** Adjusts the brightness of the screen to reduce energy.
- (Control buttons)** Control buttons for media contents.
- These access special functions in some menus.

(Some buttons and services may not be provided depending upon models or regions.)

**Note \*\*To use the button, press and hold for more than 1 second.**

## Using Magic Remote Control

(Depending on model)

The descriptions in this manual are based on the buttons on the remote control. Please read this manual carefully and use the TV correctly. When the message [Magic Remote battery is low. Please change the battery.] is displayed, replace the battery. To replace batteries, open the battery

cover, replace batteries (1.5 V AA) matching the and ends to the label inside the compartment, and close the battery cover. Be sure to point the magic remote toward the remote control sensor on the TV.

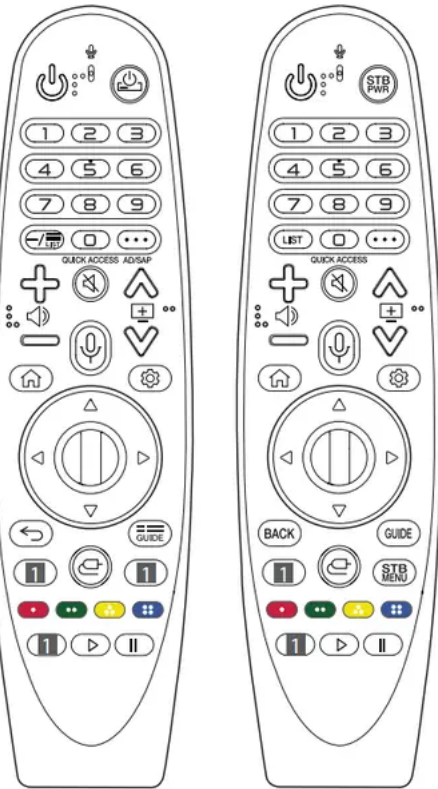

- (POWER)** Turns the TV on or off.
- / TV/STB** You can turn your set-top box on or off by adding the set-top box to the universal remote control for your TV.
- Number buttons** Enters numbers.
- \*\*** Accesses the [Quick Help].
- (DASH)** Inserts a — between numbers such as 2-1 and 2-2.
- / LIST** Accesses the saved programmes list.
- (MORE ACTIONS)** Displays more remote control functions.
- QUICK ACCESS\*\*** Edits QUICK ACCESS
  - QUICK ACCESS is a feature that allows you to enter a specified app or Live TV directly by pressing and holding the number buttons.
- AD/SAP\*\*** Audio descriptions function will be enabled.
- (VOLUME)** Adjusts the volume level.
- (MUTE)** Mutes all sounds.
- \*\*** **(MUTE)** Accesses the [Accessibility] menu.
- (SCROLL)** Scrolls through the saved programmes.
- (Voice recognition)** Network connection is required to use the voice recognition function.
  - Check for recommended content. (Some recommended services may not be available in some countries.)
  - \*\*** **(Voice recognition)** Speak while pressing and holding the button to use the voice recognition feature.
- (HOME)** Accesses the Home menu.
- \*\*** **(HOME)** Shows the previous history.
- (Q. Settings)** Accesses the Quick Settings.
- \*\*** **(Q. Settings)** Displays the [All Settings] menu.
- (WHEEL (OK))** Press the center of button to select a menu. You can change programmes by using button.
- (up/down/left/right)** Press the up, down, left or right button to scroll the menu. If you press buttons while the pointer is in use, the pointer will disappear from the screen and Magic Remote will operate like a general remote control. To display the pointer on the screen again, shake Magic Remote to the left and right.
- / BACK** Returns to the previous level.
- \*\*** **/ BACK\*\*** Clears on-screen displays and returns to last input viewing.
- / GUIDE** Shows programme guide.
- Streaming Service buttons** Connects to the Video Streaming Service.
- (INPUT)** Changes the input source.
- \*\*** **(INPUT)** Accesses the [Home Dashboard].
- STB MENU** Displays the set-top box Home menu.
  - When you are not watching via a set-top box: the display changes to the set-top box screen.
- (Special function icons)** These access special functions in some menus.
- \*\*** **(Record icon)** Runs the record function.
- (Control buttons)** Controls media contents.

(Some buttons and services may not be provided depending upon models or regions.)

**Note \*\*To use the button, press and hold for more than 1 second.**

## Registering Magic Remote Control

### How to register the Magic Remote Control

To use the Magic Remote, first pair it with your TV.



1. Put batteries into the Magic Remote and turn the TV on.



2. Point the Magic Remote at your TV and press the  **Wheel (OK)** on the remote control.

- If the TV fails to register the Magic Remote, try again after turning the TV off and back on.



### How to deregister the Magic Remote Control

Press the  (Back) and  (Home) buttons at the same time, for five seconds, to unpair the Magic Remote with your TV.

- \* Press and hold the  button for more than 5 seconds to disconnect and re-register the Magic Remote at the same time.
- Do not mix new batteries with old batteries. This may cause the batteries to overheat and leak.
- Failure to match the correct polarities of the battery may cause the battery to burst or leak, resulting in fire, personal injury, or ambient pollution.
- This apparatus uses batteries. In your community there might be regulations that require you to dispose of these batteries properly due to environmental considerations. Please contact your local authorities for disposal or recycling information.
- Batteries inside or inside the product shall not be exposed to excessive heat such as sunshine, fire or the like.

### User Guide

For more information about this TV, read the USER GUIDE embedded in the product.

- To open the USER GUIDE  →  → [Support] → [User Guide]

## Troubleshooting

<p><b>Cannot control the TV with the remote control.</b></p>	<ul style="list-style-type: none"> <li>• Check the remote control sensor on the product and try again</li> <li>• Check if there is any obstacle between the product and the remote control.</li> <li>• Check if the batteries are still working and properly installed (⊕ to ⊕ ⊖, to ⊖).</li> </ul>
<p><b>No image display and no sound is produced.</b></p>	<ul style="list-style-type: none"> <li>• Check if the product is turned on.</li> <li>• Check if the power cord is connected to a wall outlet.</li> <li>• Check if there is a problem in the wall outlet by connecting other products.</li> </ul>
<p><b>The TV turns off suddenly.</b></p>	<ul style="list-style-type: none"> <li>• Check the power control settings. The power supply may be interrupted.</li> <li>• Check if the auto-off function is activated in the settings menu.</li> <li>• If there is no signal while the TV is on, the TV will turn off automatically after 15 minutes of inactivity.</li> </ul>
<p><b>When connecting to the PC (HDMI), no signal is detected.</b></p>	<ul style="list-style-type: none"> <li>• Turn the TV off/on using the remote control.</li> <li>• Reconnect the HDMI cable.</li> <li>• Restart the PC with the TV on.</li> </ul>
<p><b>Abnormal Display</b></p>	<ul style="list-style-type: none"> <li>• If the product feels cold to the touch, there may be a small “flicker” when it is turned on. This is normal, there is nothing wrong with product</li> <li>• This panel is an advanced product that contains millions of pixels. You may see tiny black dots and/or brightly coloured dots (red, blue or green) at a size of 1 ppm on the panel. This does not indicate a malfunction and does not affect the performance and reliability of the product. This phenomenon also occurs in third-party products and is not subject to exchange or refund.</li> </ul>

	<ul style="list-style-type: none"> <li>• You may find different brightness and colour of the panel depending on your viewing position(left/right/top/down). This phenomenon occurs due to the characteristic of the panel. It is not related with the product performance, and it is not malfunction.</li> <li>• Displaying a still image for a prolonged period of time may cause an image sticking. Avoid displaying a fixed image on the TV screen for a extended length of time.</li> </ul>
<p><b>Generated Sound</b></p>	<ul style="list-style-type: none"> <li>• “Cracking” noise: A cracking noise that occurs when watching or turning off the TV is generated by plastic thermal contraction due to temperature and humidity. This noise is common for products where thermal deformation is required.</li> <li>• Electrical circuit humming/panel buzzing: A low level noise is generated from a high-speed switching circuit, which supplies a large amount of current to operate a product. It varies depending on the product. This generated sound does not affect the performance and reliability of the product.</li> </ul>

- When cleaning the product, be careful not to allow any liquid or foreign objects to enter the gap between the upper, left or right side of the panel and the guide panel.  
(Depending on model)

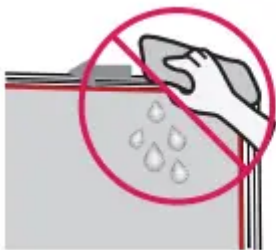

- Make sure to wring any excess water or cleaner from the cloth.
- Do not spray water or cleaner directly onto the TV screen.
- Make sure to spray just enough of water or cleaner onto a dry cloth to wipe the screen.

**Warning**

This content is compiled from multiple sources and is provided for reference purposes only. It may not be complete or fully applicable to all situations. If you are unable to resolve your issue, please contact the product manufacturer or an authorized service provider for official support.

---

Document generated by [ManualsFile](#)

