

## Connections and Setup

### TV Buttons

If the batteries in your remote control are run down, you can use the buttons on your TV set. They have the following functions:

For models with below buttons on the set:

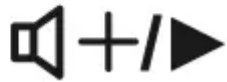
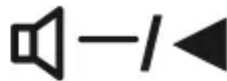

**Features (Short press)**  
⏻ (Long press)

For models with below buttons on the set:

	<b>TV mode</b>	<b>In menus</b>
▲	P ▲	▲
▼	P ▼	▼
➤	🔊 +	➤
➤	🔊 -	➤
⏻	<b>Features (Long press)</b> <b>OK (Short press)</b>	<b>Features (Long press)</b> <b>OK (Short press)</b>

For models with only one button on the set:



**Note:** Figures and illustrations are provided for reference only and may vary depending on the model.

## Initial Setup

The first time you switch the set on, the Welcome screen appears, which guides you through the initial setup process. Follow the on-screen instructions to finish the initial setup process such as selecting the language, connecting to the network, scanning channels, and more. During each step, either make a choice or skip the step. If you skip a step, you can perform the setup later from the settings menu.

**Note:** If the channel search retrieved only the analogue channels it could be caused by poor broadcasting and therefore is not covered by manufacturer warranty. Manufacturers cannot be held responsible for lack of or poor broadcasting in some areas.

Google setup and TCL initial setup

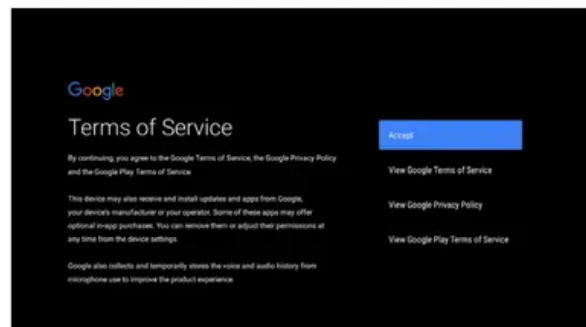
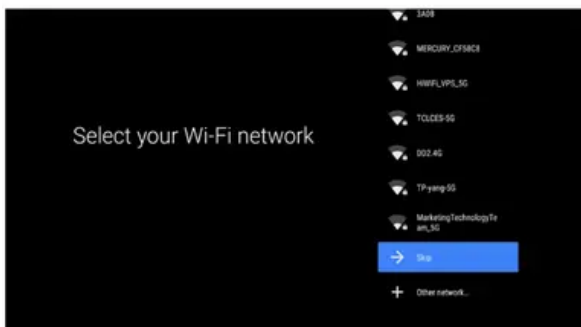
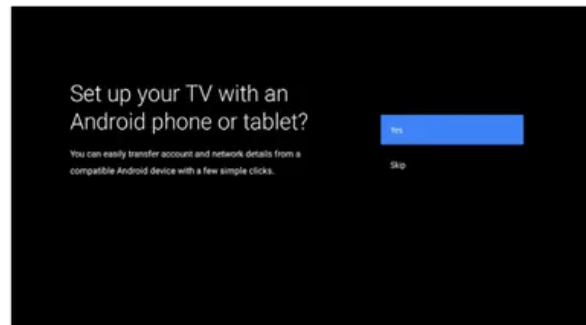
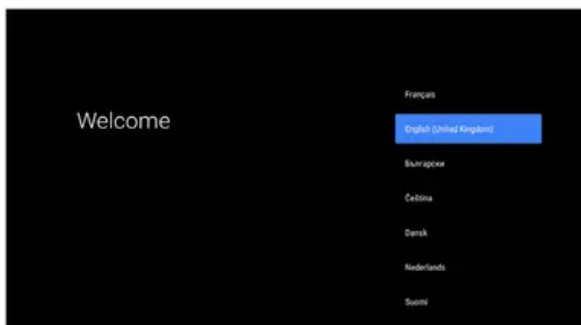

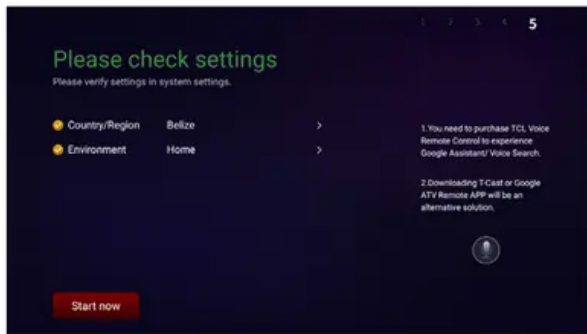
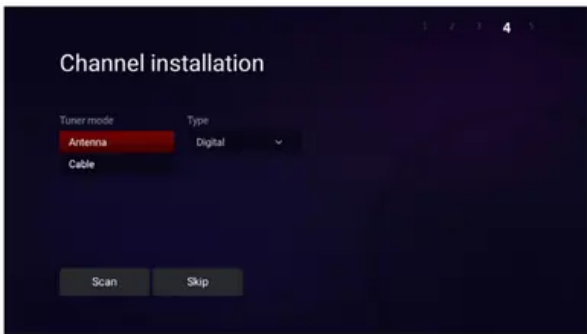
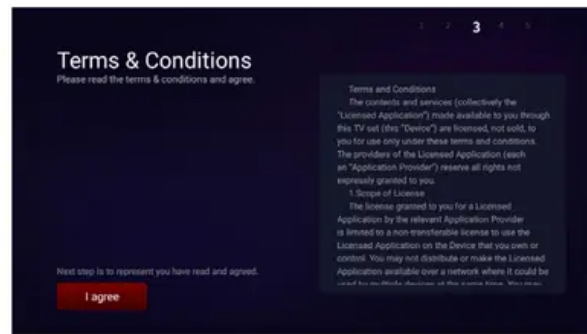
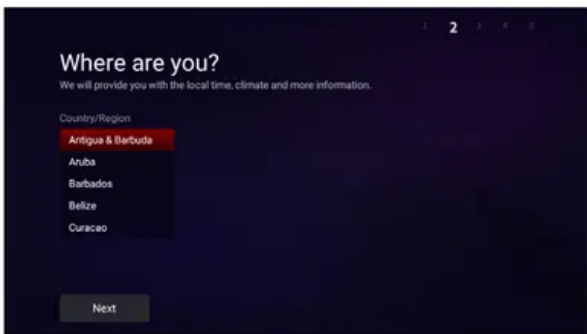
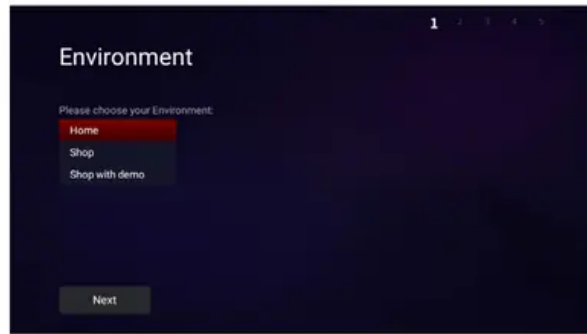
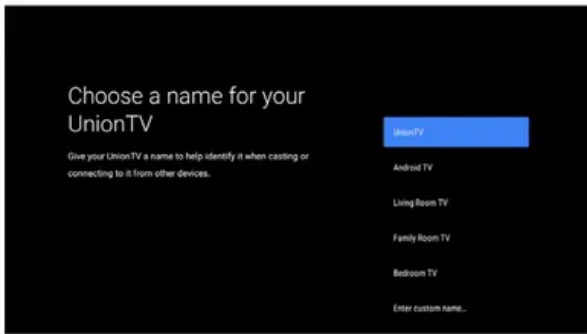
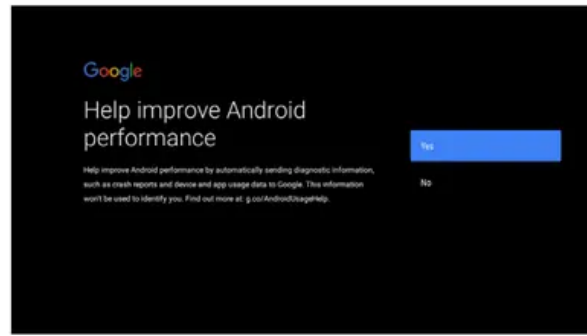
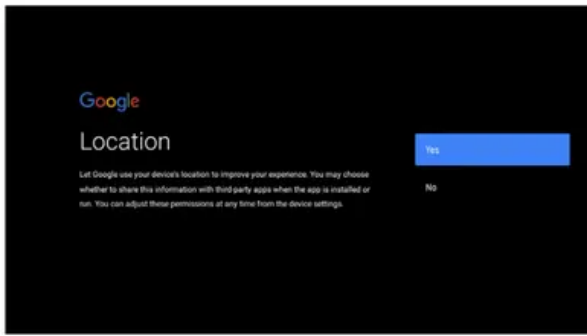

## Sockets

**Note:** The location and names of the sockets on the TV may vary according to TV model, and not all sockets are available on all models.

### USB2.0 socket (input)

These sockets can be used to connect a USB device.

**Note:** The number of USB sockets on the TV may vary according to TV model.

## USB 2.0

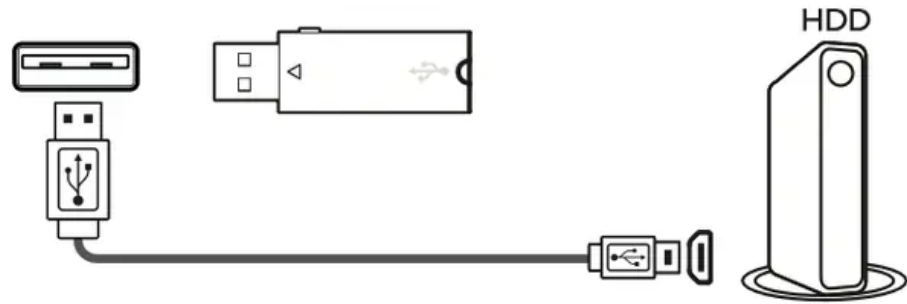

## HDMI(SERVICE) or HDMI(ARC) socket (input)

The HDMI (High-Definition Multimedia Interface) socket can be used to connect a Blu-ray player, PC with a compatible video card installed, certain DVD players or a high-definition compatible digital satellite decoder. This socket provides an uncompressed digital connection that carries both video and audio data by way of an integrated mini-plug cable.

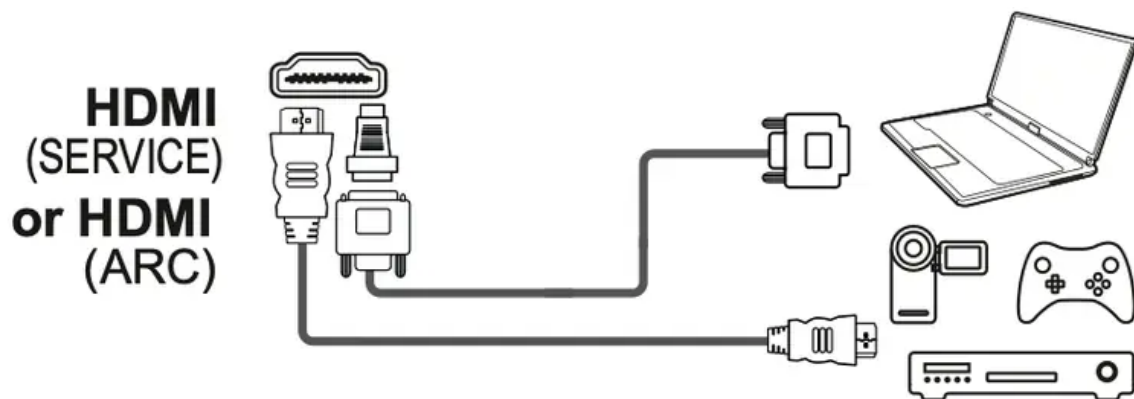

## AV IN adapter socket

The AV IN adapter socket can be used to connect the attached AV adapter cable with VIDEO and AUDIO L & R IN sockets. The AV IN sockets can be used to connect a range of equipment, including video recorders, camcorders, decoders, satellite receivers, DVD players, or games consoles. The VIDEO IN socket provides composite video connection.

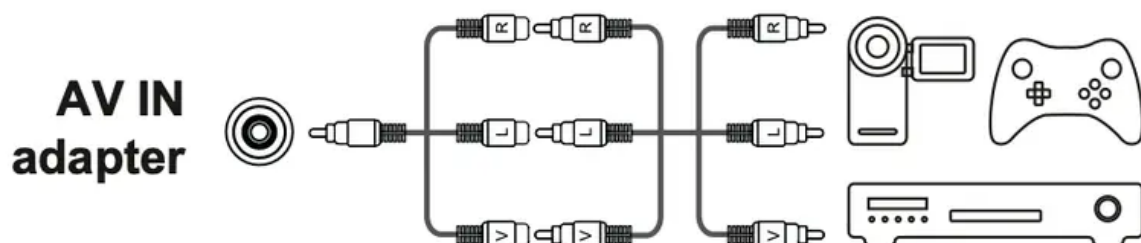

## ANTENNA IN socket (input)

This socket can be used to connect an outside aerial.

## ANTENNA IN

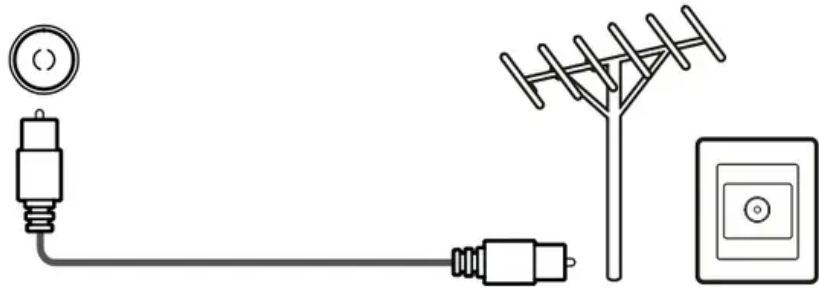

## LAN

RJ45 plug for connecting to external modem or network access equipment.

## LAN

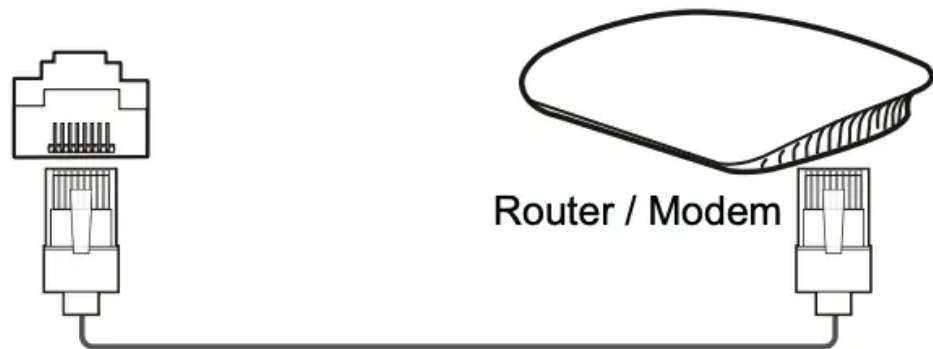

## SPDIF socket (output)

The SPDIF socket can be used to connect a compatible digital audio receiver.

## SPDIF

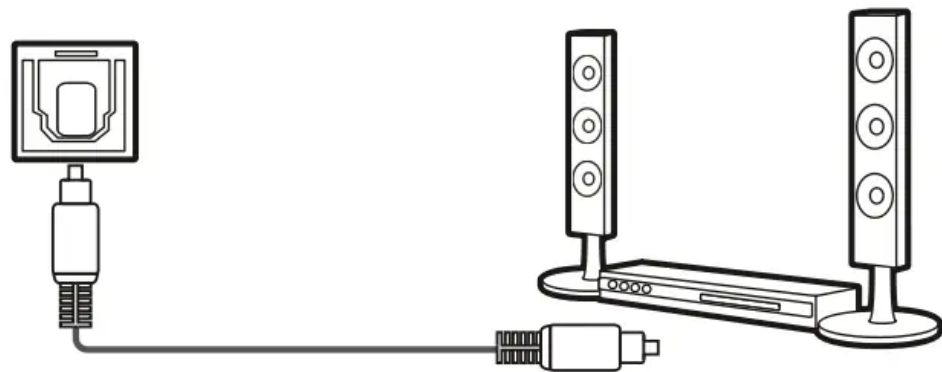

## Headphone socket (output)

This socket can be used to connect headphones or stereo earphones.

**Warning:** Excessive sound pressure from earphones and headphones can cause hearing loss.





## Remote Control Functions

Most of your television's functions are available via the menus that appear on the screen. The remote control supplied with your set can be used to navigate through the menus and to configure all the general settings.

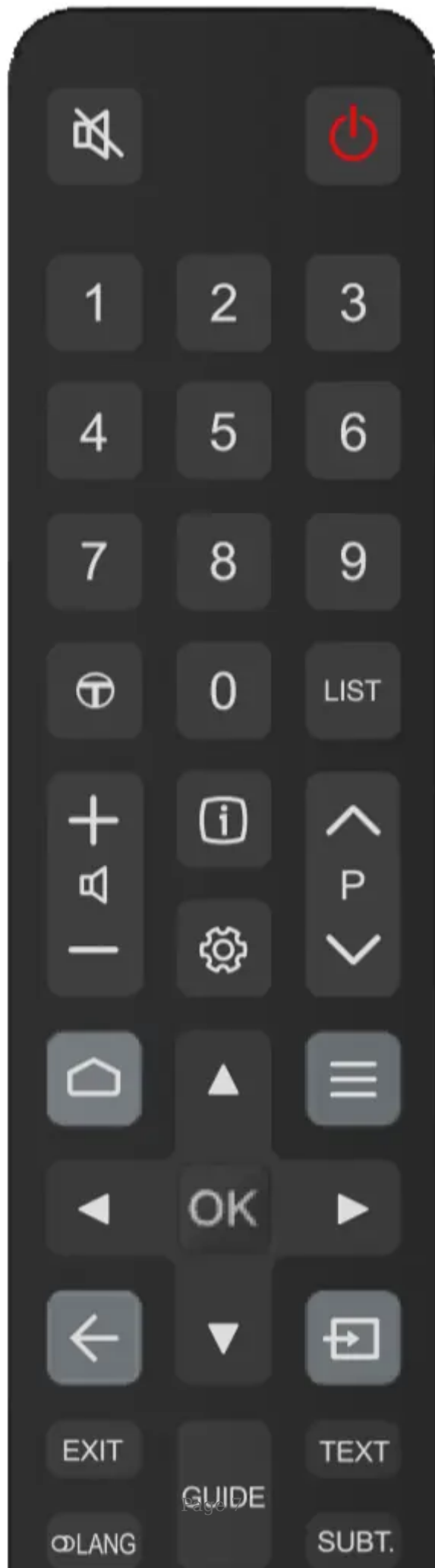
**Note:** Figures and illustrations in this operation manual are provided for reference only and may differ from actual product appearance. Certain function may not be available for some models, e.g. GUIDE/SUBTITLE functions are only available under DTV source. And DTV is not available for certain model.



 To switch the sound off and back on.

 Standby / quit standby.

**Numeric buttons** To enter channel numbers or a digit.

 To access T recommended apps.

**LIST** To display the channel list.

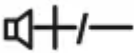
 To control the volume.

 To display program information, if available.

 To display the Settings menu.

 To change channels.

 To access the Smart TV homepage.

 To display the Option menu.

 Navigation direction buttons.

**OK** To confirm an entry or selection.

 To return to the previous menu or quit an App.

 To select input source.

**EXIT** To exit the Settings menu.

 **LANG** To select an audio language available for selected digital TV program.

**GUIDE** To toggle the Electronic Program Guide on or off. (only available for digital channels.)

**TEXT** To toggle Teletext on or off.

**SUBT.** To select a subtitle language available for selected digital TV program.

**Colour buttons** To select tasks or Teletext pages; to be used for HbbTV function.

 To start fast reverse.

 To pause playback.

 To start fast forward.

**ZOOM** To select the desired screen format.

**Note:** You are recommended to use the full screen mode. Do not use the display mode with black bars on both sides of the picture (such as 4:3) for a long time; otherwise the TV screen may be damaged permanently.

▶ To start playback.

■ To stop playback.

**NETFLIX** To access the NETFLIX application. (Not available for some models.)

### Installing Batteries

1. Push to open the back cover as illustrated.
2. Insert two AAA batteries according to the polarities marked on the battery case.
3. Replace the back cover as illustrated.

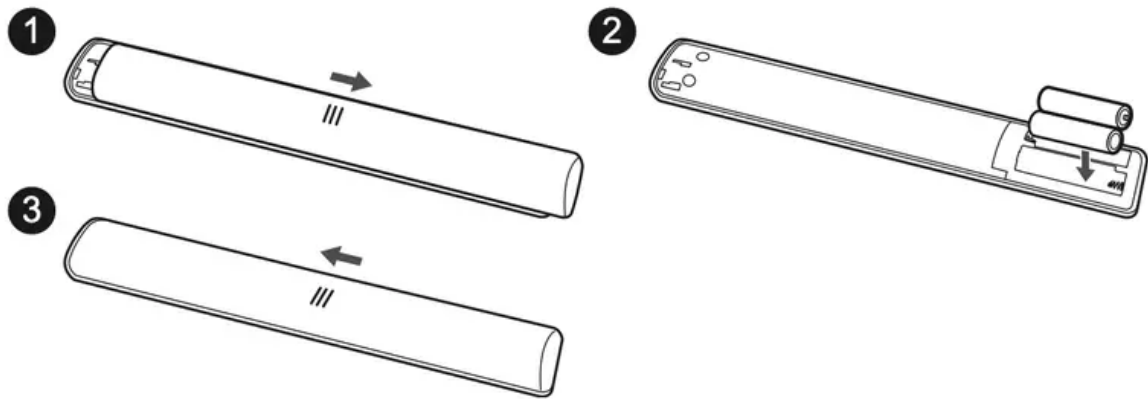

### Exclusive Remote Control

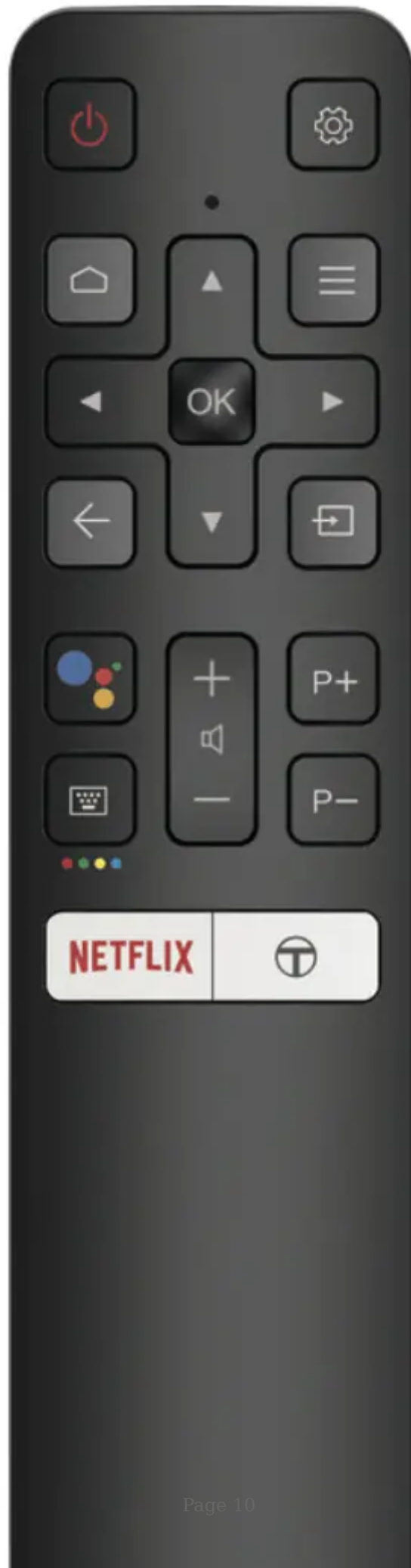



Standby / quit standby..



To display the Settings menu.



To access the Smart TV homepage.



To display the Option menu.

▲/▼/◀/▶ Navigation direction buttons. The ▲/▼ buttons are also used to change channels in TV mode.

**OK** To confirm an entry or selection. The button is also used to display the channel list in TV mode.



To return to the previous menu or quit an App.



To select input source.



**Google Assistant** Press to activate and use Google Assistant. (Available only when the network connection works normally.)



To pop up the virtual remote control keyboard when available.

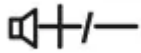

To control the volume.

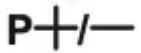

To change channels.



To access Netflix. (Not available for some models.)



To access T recommended Apps.

**Note:** This remote control is available only for selected models. The remote control type may be changed without notice.

### How to Use the Remote Control



When using button for the first time, you will be prompted to pair the remote with the TV. Please follow the onscreen guide for pairing instructions.

a. Keep the remote control and TV in 1 meter, press OK and button on the remote at the same

time. You can use button after activating successfully.



- b. This voice search function is only available for content search from certain Apps.
- c. Set languages in the TV settings to your local language or official language to enhance voice search successfully.

### Installing Batteries

1. Push to open the back cover as illustrated.
2. Insert two AAA batteries according to the polarities marked on the battery case.
3. Replace the back cover as illustrated.

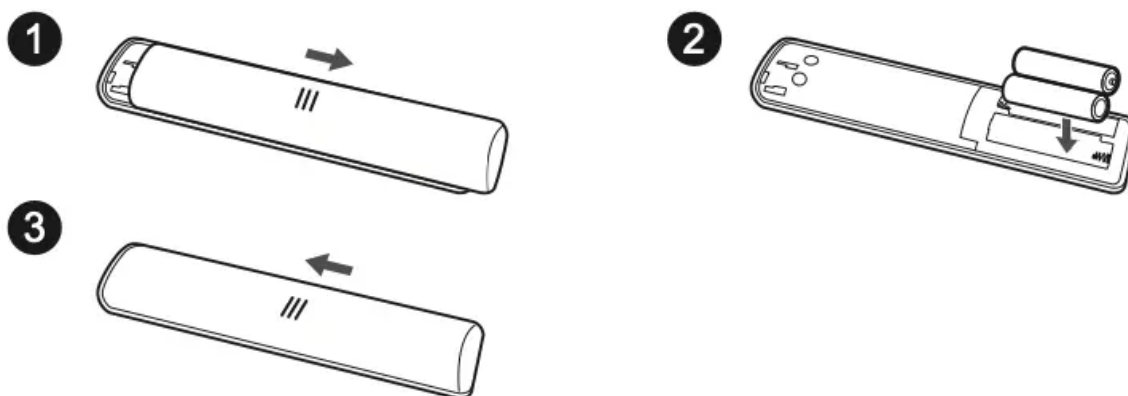

### Network Connection

Your TV will require an internet connection to operate all functions. Data usage charges may apply. Please refer to your Internet Service Provider (ISP) for additional information.

To access the internet, you must subscribe to high speed broadband internet service from your internet service provider.

Your TV can be connected to your home network in two ways:

- Wired, using the RJ45 (LAN) connector on the back panel.
- Wireless, using the internal wireless or external wireless USB adapter and your home wireless network.

**Note:** The following instructions are just the usual ways to connect your TV to the wired or wireless network. The connection method may be different depending on your actual network configuration. If you have any questions about your home network, please refer to your ISP(Internet Service Provider).

### Connecting to a wired Network

To connect to a wired network:

1. Ensure you have:
  - An Ethernet cable long enough to reach your TV
  - A router or modem with an available Ethernet port
  - A high-speed internet connection
  - An Ethernet (LAN) port on the back of the TV
2. Connect your Ethernet cable to the router and to the Ethernet port on the back of the TV.
3. Use the Network menu to configure the TV.

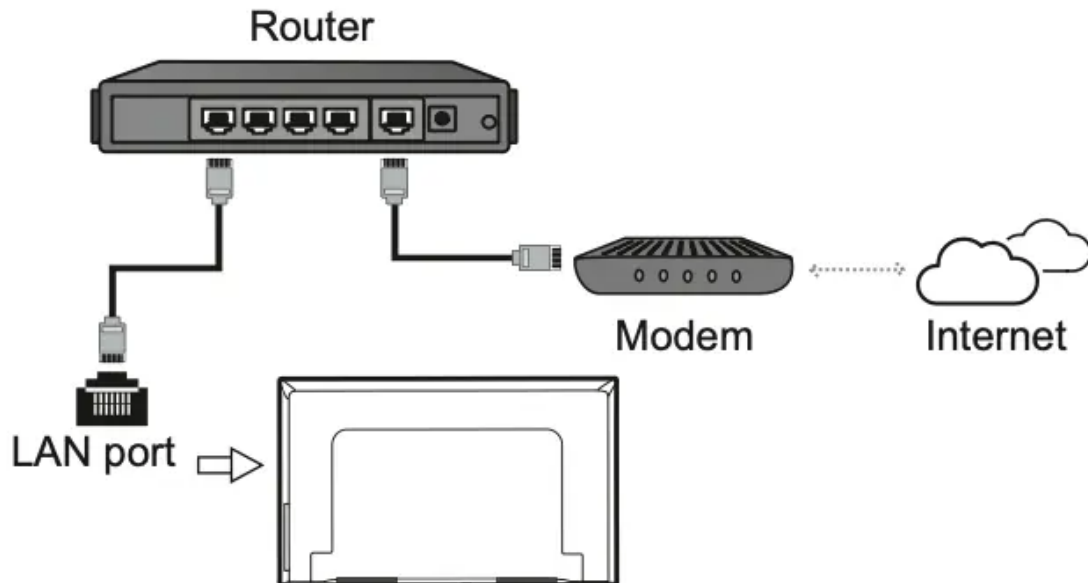



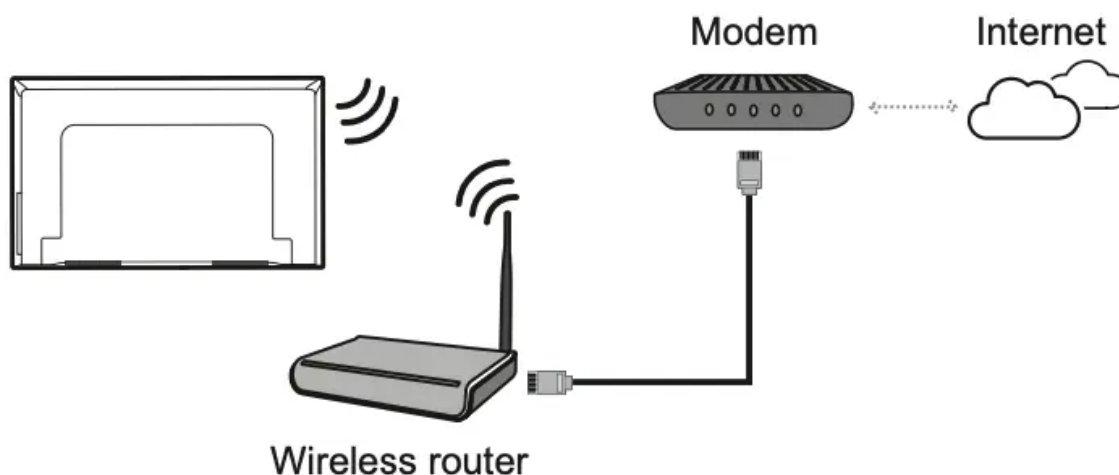

### Connecting to a Wireless Network

To connect to a wireless network

1. Ensure you have:
  - A router broadcasting a high-speed wireless signal
  - A high-speed internet connection
2. Use the Network menu to configure the TV.



**Note:** Please follow below steps to enter the Network menu.

1. Press  on the remote control to display the Smart TV homepage.
2. Press  to move the cursor to  (Settings) on the right top of the screen and press OK to enter.
3. Press  to select Network, then press OK to enter the submenu and follow the on-screen guidance to set up your network.

## Switching On

Follow the instructions on this page on how to switch on your TV set and the remote control before going on to following pages describing how to use the channel set-up procedure.

1. Insert two AAA batteries in the remote control.  
 Precautions on using batteries:  
 Only use the battery types specified.  
 Make sure you use the correct polarity.  
 Do not mix new and used batteries.  
 Do not use rechargeable batteries.  
 Do not expose batteries to excessive heat such as sunshine, fire or the like, throw them in a fire, recharge them or try to open them, as this could cause them to leak or explode.  
 Remove the batteries from the remote control if you are not using it for a long period of time.  
 Attention should be drawn to the environmental aspects of battery disposal.
2. Connect the power cable FIRST to the television, THEN to a mains socket. (Note: If the power cable is connected to the television, please only connect the power cable to the mains socket.)  
 Your TV set should only be connected to an AC supply. It must not be connected to a DC supply. If the plug is detached from the cable, do not, under any circumstances, connect it to a mains socket, as there is a risk of electric shock.

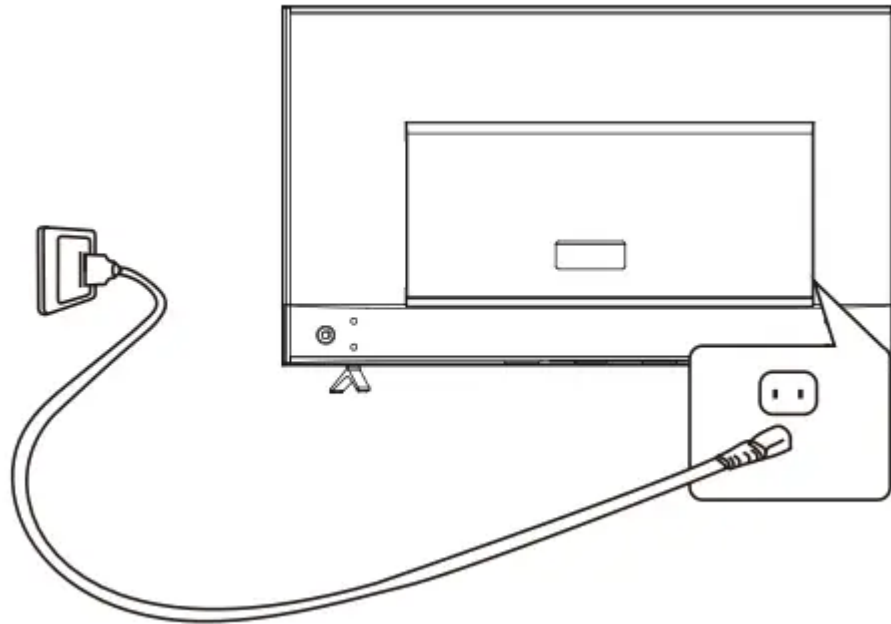

**Note:** The figures are for representation only, the location of power socket of the television might differ depend on the model.

3. Connect an outside aerial to the ANTENNA IN socket at the back of the TV set.  
The aerial socket (75 OHM - VHF / UHF / cable) can be used for connecting an external aerial or other equipment fitted.

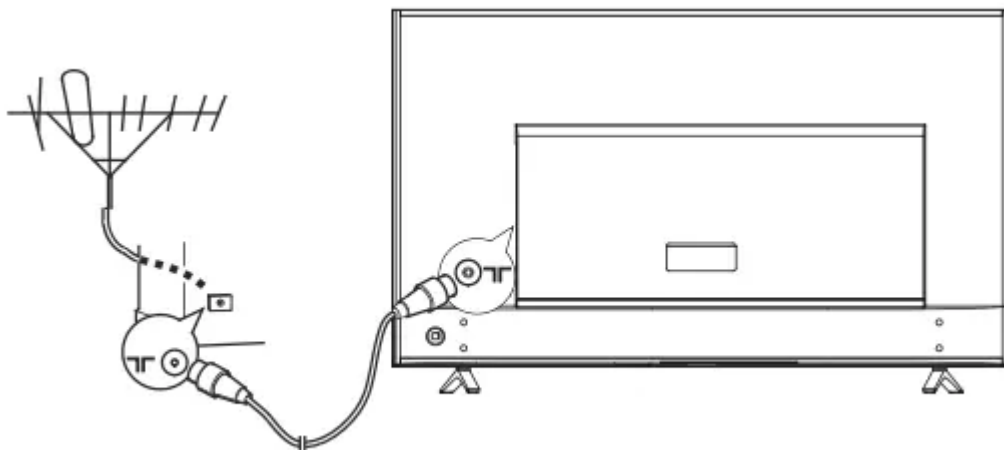

**Note:** If you want to receive the signal from your cable or cable box, please connect a coaxial cable to the ANTENNA IN socket at the back of the TV set.

4. When powered on, the TV will be turned on directly or be in standby mode.

If the power indicator lights up, the TV set is in standby mode. Press the  button on the remote control or on the TV set to turn on the TV.

## Switching Off

To put the TV set into standby mode, press the  button on the remote control. The TV set remains powered up, but with low energy consumption.

To switch off the TV set, unplug the mains socket from the mains outlet.

## Basic TV Operations

### Accessing Channels



#### Using the remote control of RC802N

**Using the numeric buttons:** press the corresponding numeric buttons on the remote control to access the channels.



**Using the  buttons:** press the  buttons on the remote control to scroll through the channels.

**Using the LIST button:** press the LIST button to display the channel list and press  and OK to select channels.



#### Using the remote control of RC802V





**Using the  buttons:** press the  buttons on the remote control to scroll through the channels.

**Using the OK button:** press the OK button to display the channel list and press  and OK to select channels.

**Using the  button:** press  to display the virtual remote control keyboard, then you can use the numeric buttons, the P+/P- buttons or the LIST button to operate accordingly.



### Watching Connected Devices

Press  on the remote control to display the source list. Press  to select TV or other input sources and press OK to confirm.

You can also press  on the remote control to display the homepage, press  to move the cursor to the  (Inputs) area on the right top of the screen, and press OK to enter. Then press  and OK to select the input source.

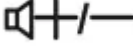
## Adjusting Volume

**Volume control:** press the  buttons on the remote control or the corresponding buttons on the TV set to increase or decrease the volume.

**Sound mute:** press the  button to temporarily mute the sound. Press this button again or the  button to restore the sound.

## Accessing Smart TV Homepage

Allows you to enjoy Internet Applications (Apps) and specially adapted Internet websites, and perform system settings for your TV. You can make controlling with the TV remote control.

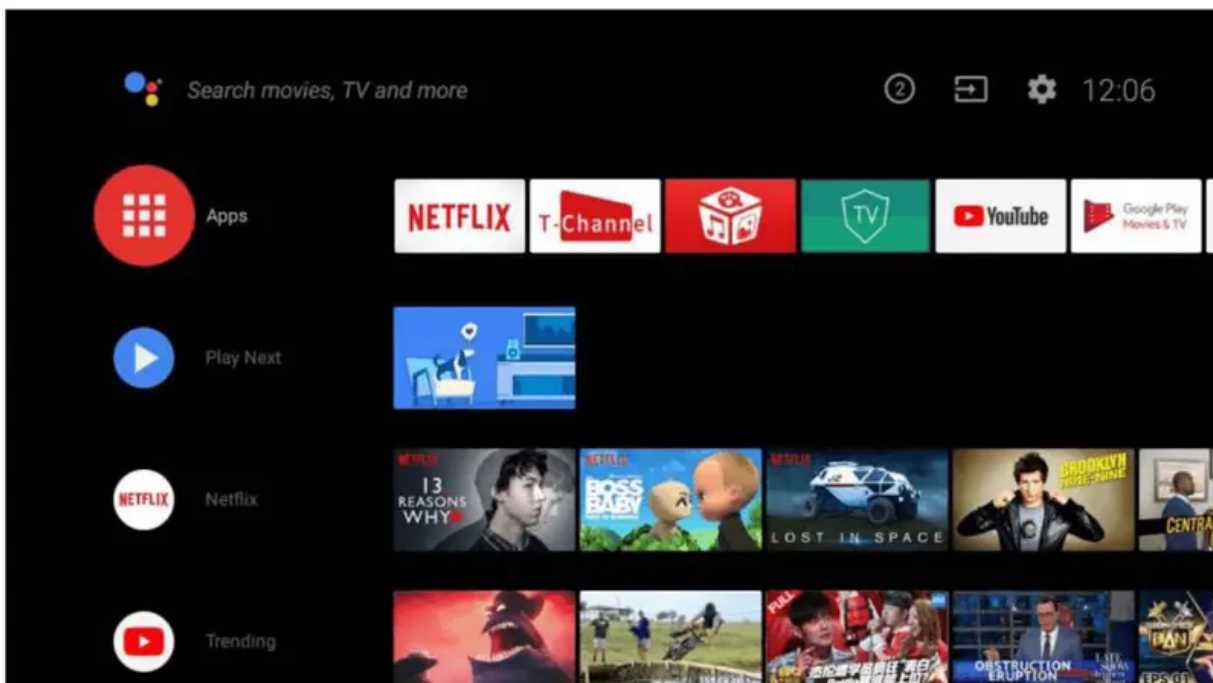

### WARNING:

- Configure the network settings before using Smart TV applications.
- Slow responses and/or interruptions may occur, depending on your network conditions.
- If you experience a problem using an application, please contact the content provider.
- According to circumstances of the content provider, an application's updates or the application itself may be discontinued.
- Depending on your country's regulations, some applications may have limited service or not be supported.
- Changes in application content may be made without prior notice by the service provider.

1. Press  on the remote control to display the Smart TV homepage.

2. Press ▲/▼/◀/▶ and OK to enter the desired Apps, functions or settings.

3. Press ← to return to the homepage.

4. To exit the homepage, press ▲/◀/▶ to move the cursor to the  (Inputs) area on the right top of the screen, press OK to enter and then press ▲/▼ and OK to select your desired input source.

**Note:** Since the connection with Internet takes time, it's recommended that you wait a few minutes to use the Smart TV feature after activation of TV from standby.

## Accessing Google Play

Google Play is your entertainment unbound. It brings together all of the entertainment you love and helps you explore it in new ways, anytime, anywhere. We've brought the magic of Google to music, movies, TV, books, magazines, apps and games, so you get more from your content every day.

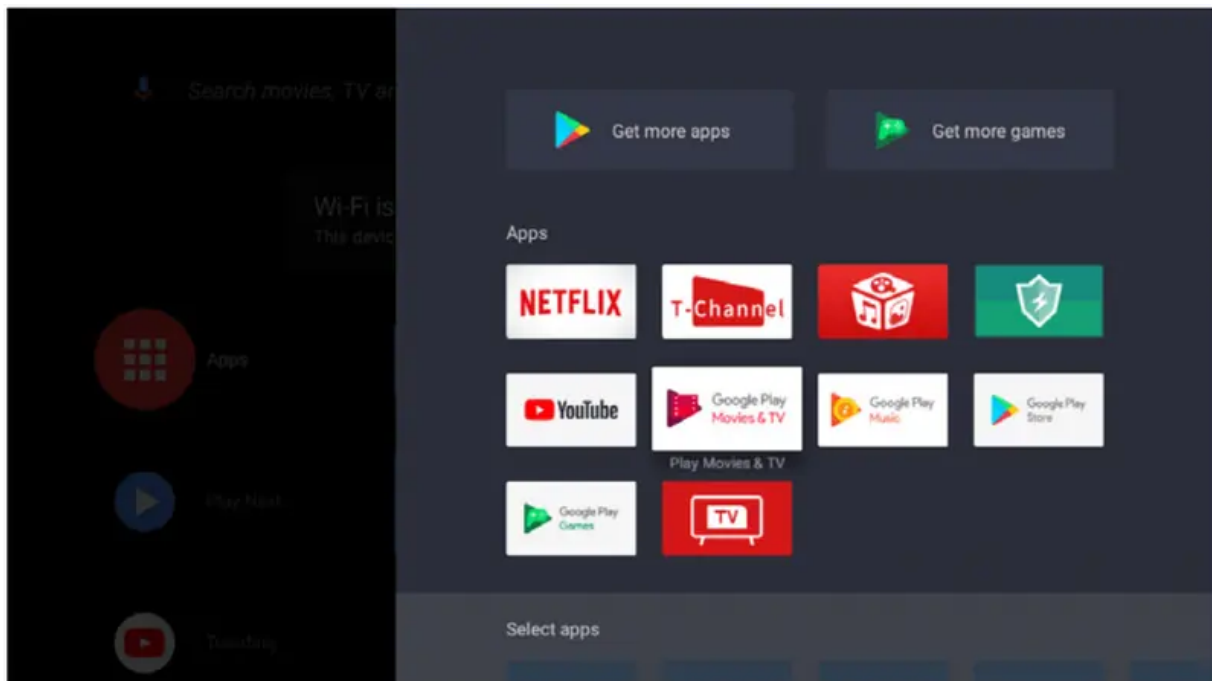

1. Press  on the remote control to display the Smart TV homepage.



2. Press ▲/▼ to select the Apps, and press OK to enter. Then press ▲/▼/◀/▶ and OK to enter the desired Apps.

3. Press ← to return to the homepage.

## Accessing T recommended

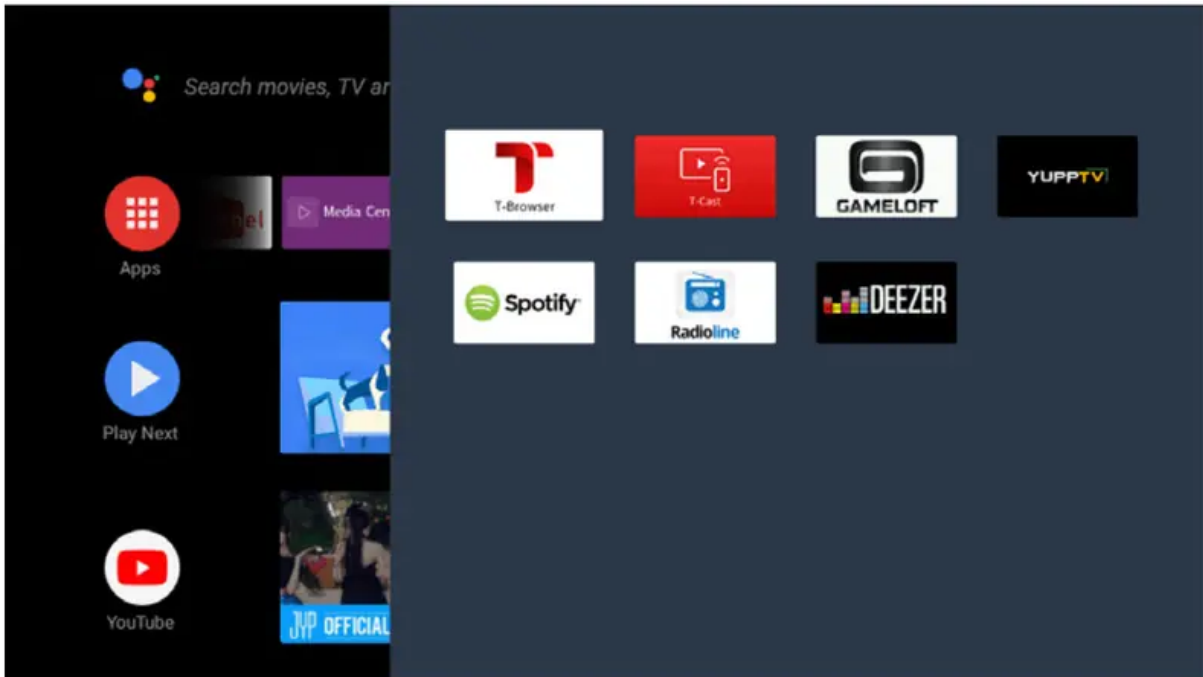
Allows you to enjoy Internet Applications (Apps).





1. Press  on the remote control to display the recommended apps.
2. Press  and OK to enter the desired Apps.
3. Press  to return to the recommend page and exit.

### Using System Settings menu

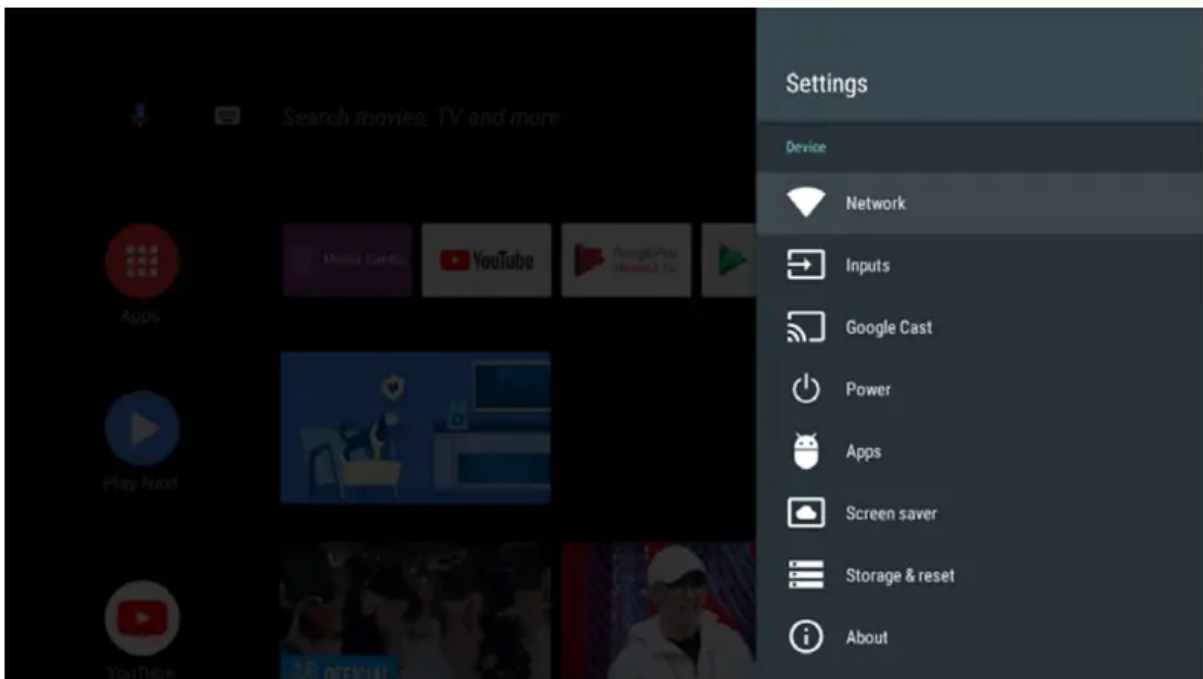
Allows you to not only adjust device settings, such as Network, Inputs, Google Cast, Power and Apps, etc., but also set preferences.





1. Press  on the remote control to display the Smart TV homepage.

2. Press ▲/◀/▶ to move the cursor to  (Settings) on the right top of the screen and press OK to enter the system settings.
3. Press ▲/▼ to choose the items and press OK to enter.
4. Press  to return to previous interface.
5. Press EXIT to close the menu.

## Using Instant Power On

It enables you to turn on your TV faster from standby mode than turning this function off, but it will also increase standby power consumption.



1. Press  on the remote control to display the homepage, Press ▲/▼/◀/▶ to select  > Power > Device > Instant power on and press OK to toggle between On and Off.
2. Press  to return to the homepage.

## Using TV Settings menu

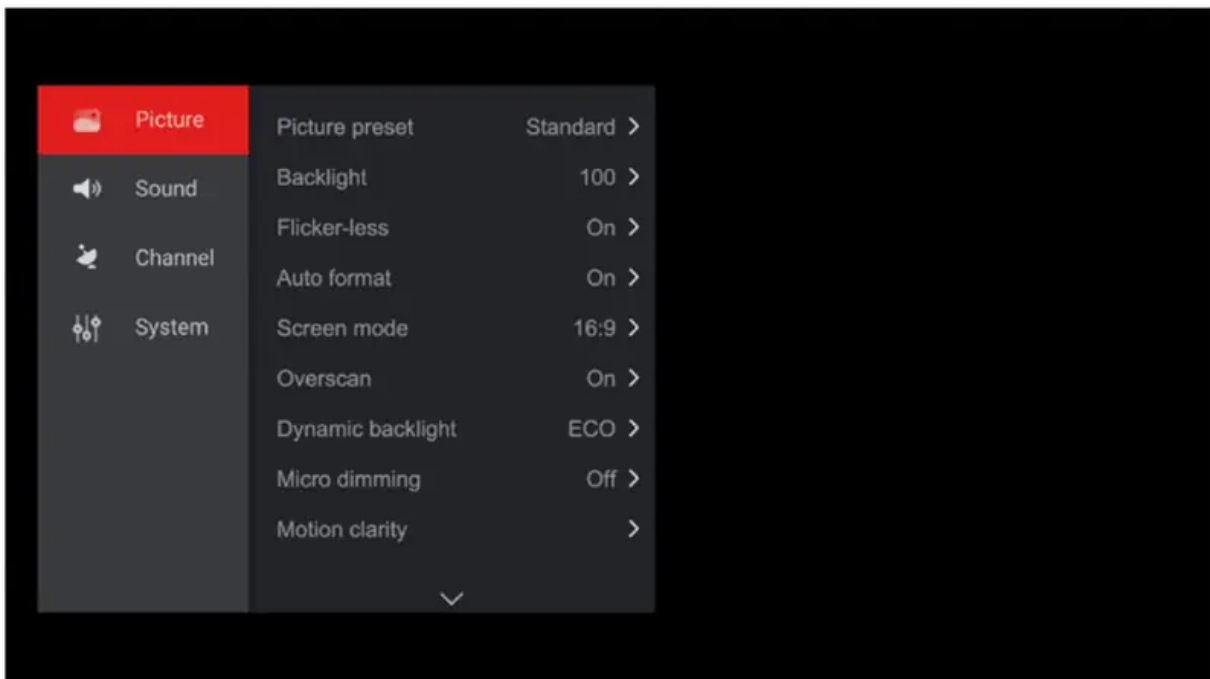
Allows you to adjust TV settings, such as picture and sound.



1. Press  on the remote control to display the Settings menu.
2. Press ▲/▼ to select the desired item, then press ▶ to enter the corresponding submenu.
3. In submenus, press ▲/▼ to select menu options, then press **OK/▶** to enter the option list, the adjustment interface, or the corresponding submenu.

4. Press  to return to the previous menu.
5. Press EXIT or  to close the menu.



**Notes:**

- You can also press  on the remote control, select Settings (if available) and press OK to enter the Settings menu. Some options may not be available for certain signal sources.
- Setting LED Motion clear on will make fast moving images clearer by controlling the LED backlight, but the picture will be darker and more flickering than with LED Motion clear off.

## Using more of your TV

### Installing Channels

This section describes how to search and store channels automatically. This may be done in any of the cases below:



- you have skipped the channel installation step in the initial setup;
  - you are prompted that there are no channels in TV mode;
  - you want to update your channels.
1. In TV mode, press  on the remote control and select Channel > Channel scan. Press OK/▶ to enter.
  2. The TV installs and arranges channels according to your country or region. Press ▲/▼ to select Country/Region, and press OK/▶ to enter. Enter the default password 1234 or your own password in case you have changed the password in the System > Lock menu. Press ▲/▼ to select your country or region and press OK to confirm.
  3. Press ▲/▼ to select Automatic search and press OK/▶ to enter.
  4. Press ▲/▼ to select Channel type and press ◀/▶ to select Digital, Analogue or Digital&Analogue.
  5. After configuration is completed, press ▼ to select Search and press OK to start scanning channels.
  6. The channel search may take a few minutes. After the automatic search, channels are arranged in a preset order. If you wish to hide or move channels, press  on the remote control, select Channel > Channel organizer and press OK/▶ to enter.

## Using Subtitles



You can enable subtitles for each TV channel. Subtitles are broadcast via Teletext or DVB-T digital broadcasts. With digital broadcasts, you have the additional option of selecting a preferred subtitle language.

**Note:** Some options are available only when Subtitle is set to On.

### Turning On/Off Subtitles



1. Press  on the remote control, select Channel > Subtitle and press OK/▶ to enter.
2. Select the Subtitle option, press OK/▶ to enter, press ▲/▼ to select On or Off and press OK to confirm.
3. Press EXIT or  to close the menu.

### Enabling Subtitle Languages on digital TV Channels

1. Press  on the remote control, select Channel > Subtitle > Digital subtitle language 1st and press OK/▶ to enter.
2. Press ▲/▼ to select a subtitle language as your preferred language and press OK to confirm.
3. Press ▲/▼ to select Digital subtitle language 2nd and press OK/▶ to enter.
4. Press ▲/▼ to select a secondary subtitle language and press OK to confirm.
5. Press EXIT or  to close the menu.

**Shortcut operation:** Press SUBT. on the remote control to directly select a subtitle language available for the selected digital TV program.

### Selecting a Subtitle Type on Digital TV Channels

1. Press  on the remote control, select Channel > Subtitle > Subtitle type and press OK/▶ to enter.
2. Press ▲/▼ to select a subtitle type and press OK to confirm. You can select Hearing impaired to display the hearing impaired subtitles with your selected language.
3. Press EXIT or  to close the menu.

## Using Teletext



### Selecting Decoding Page Language

1. Press  on the remote control, select Channel > Teletext > Decoding page language and press OK/▶ to enter.
2. Press ▲/▼ to select a proper type of language in which Teletext will display and press OK to confirm.

3. Press EXIT or  to close the menu.



### Digital Teletext Language

On digital TV channels, depending on the broadcaster, you may be able to enjoy a service with multiple initial Teletext pages in different languages. This function allows you to select an available language as primary language, which relates to different initial Teletext pages.

1. Press  on the remote control, select Channel > Teletext > Digital teletext language and press OK/▶ to enter.
2. Press ▲/▼ to select a language and press OK to confirm.
3. Press EXIT or  to close the menu.

### Network waking up

This function allows you to turn on your TV from standby mode via a network. To use this function, please make sure:



1. Your TV is connected to an effective home network;
2. The desired controller, such as a smartphone, is connected to the same network as your TV;
3. An App which supports network waking up function, has been installed into the controller;
4. Networked standby is set to On in the Network menu under homepage by pressing  >  (Settings) > Device > Network.

When the TV is in networked standby mode, you can use the App to wake up the TV remotely.

### T-Link

Use this function to search for CEC devices connected to the HDMI sockets in your TV and enable auto power on and auto standby between the TV and CEC devices.

#### Enabling or Disabling T-Link

1. Press  on the remote control, select System > T-Link and press OK/▶ to enter.
2. Press ▲/▼ to select T-Link and press OK/▶ to enter.
3. Press ▲/▼ to select On or Off and press OK to confirm.
4. Press EXIT or  to close the menu.

#### Using Auto Power On

Enables the TV to automatically power on when you power on a CEC device (e.g. DVD) with the device's remote. Select On to enable this function.

#### Using Auto Standby

Enables all CEC devices to automatically go to the standby mode when you turn off the TV with the TV remote. Select On to enable this function.

**Note:** The CEC functions depend on the devices connected and it is possible that some devices may not interoperate correctly when connected to this TV. The user manual or the manufacturer of the problematic devices should be consulted for further information.

## HbbTV

HbbTV (Hybrid broadcast broadband TV) is a service offered by certain broadcasters and available only on some digital TV channels. HbbTV delivers interactive television over broadband Internet. These interactive features are added to and enrich the normal digital programs, and include services such as digital teletext, electronic program guide, games, voting, specific information related to the current program, interactive advertising, information magazines, catch-up TV, etc. To use HbbTV please ensure your TV is connected to Internet and HbbTV is switched on.

### Notes:

- HbbTV services are broadcast- or countrydependent and may be unavailable in your area.
- You cannot download files to your TV with HbbTV function.
- Application provider or broadcasting related conditions may cause an HbbTV application to be unavailable momentarily.
- To access HbbTV applications you must connect your TV to the Internet via a broadband link. HbbTV applications may not work correctly in case of network related issues.

### HbbTV Access

1. Press  on the remote control, select System > Advanced settings > HbbTV and press OK/▶ to enter.
2. Press ▲/▼ to select On and press OK to confirm.
3. When you tune to a digital TV channel that offers HbbTV, this will be signaled to you by an on-screen indication (generally a red button, but other colour buttons may also be used). Press the indicated colour button to open the interactive pages.
4. Use ▲/▼/◀/▶ and the colour buttons to navigate through the HbbTV pages and press OK to confirm.

### HbbTV Deactivation

To avoid disturbances that may be caused by HbbTV broadcasting tests, you can turn off the HbbTV function:

1. Press  on the remote control, select System > Advanced settings > HbbTV and press OK/▶ to enter.

2. Press ▲/▼ to select Off and press OK to confirm.

## Google Cast

Google Cast™ lets you cast your favorite videos, games, and apps from your mobile device, in full quality, to your TV. Just one tap of the Cast button on your Android or iOS screen is all you need to supersize the things you love. Cast your content then continue browsing on your phone or tablet.

## Using EPG (Electronic Program Guide)

EPG is an on-screen guide that displays scheduled digital TV programs. You can navigate, select and view programs.

**Note:** The DTV EPG does not require an internet connection. To use the DTV EPG, HbbTV must be set to Off. when HbbTV is set to ON, then it will enter the HbbTV EPG directly. Please refer to “HbbTV” part of this manual for assistance to set HbbTV to on or off.

1. Press  on the remote control, select Channel > EPG and press OK/▶ to enter. The Program Guide menu will appear, which allows you to get information about the current or next program playing on each channel. Navigate through the different programs using the ▲/▼/◀/▶ buttons on the remote control.

2. Use the related buttons shown at the bottom of the screen to view EPG.

Program filter: Program guide filter for digital TV programs.

Press  to display the type list of the program.

Navigate through the different types using the ▲/▼ buttons on the remote control.

Select one or more types, which you want to highlight from the type list, press OK to select or deselect. A checkmark will appear to the right of the type when selected.

**Custom schedule:** Press ▲/▼ to select a program, then press the RED button to set the schedule, press OK to enter Schedule reminder.

**Select date:** Press the GREEN button to select date.

**Schedule list:** Press the YELLOW button to view your schedule list.





**Note:** If using the remote control of RC802V, to access the colour buttons, you need to press  button on the remote control to display the virtual remote control keyboard first.

3. Press  to exit EPG.

## Bluetooth Function

(\* not available for some models)

Bluetooth® is a wireless technology standard for exchanging data over short distance between Bluetooth devices. You can connect Bluetooth audio device, mouse or keyboard via the TV.

1. Press  on the remote control, press  /  /  to move the cursor to the  (Settings) area on the right top of the screen and press OK to enter.
2. Move to the Remote & accessories area, select Add accessory and press OK to enter. The TV will search nearby Bluetooth devices automatically.
3. Select an available device, press OK and follow the guides on the screen to connect it.

**Note:** Bluetooth technology (if available in your TV) uses 2.4GHz frequency thus close proximity to WiFi access points, routers or microwave ovens might interfere with Bluetooth audio streaming. If you face interruptions in audio reception, you should restart your Bluetooth device to find frequency with less interferences and if you continue to face issues you should move closer to TV or increase space between TV and source of interferences.

The Bluetooth word mark and logos are registered trademarks owned by Bluetooth SIG, Inc. and any use of such marks by TCL is under license. Other trademarks and trade names are those of their respective owners.

## Freeview Plus

Freeview Plus is a new television service which provides a state of the art EPG and seamless access to Catch Up TV from free-to-air networks with the simple press of a button. Freeview Plus provides an unrivalled user experience and places free to air television at the forefront of innovation, with services that include:

- A 7-day, easy-to-use EPG
- All available Catch Up TV on the TV screen
- Featured recommendations
- Ability to browse by genre and search programs for the next 7 days
- A favourite function with reminders for live and Catch Up programs

## What You Need

You need a high-speed (broadband) internet connection to the TV.

## To Launch Freeview Plus

When you are watching TV, you will briefly see a prompt at the top left of the screen. Press the corresponding colour key on the remote control to launch Freeview Plus. Follow the on-screen instructions and use the colour keys, arrow keys, and OK button to navigate.

## HDR Playback

Your TV supports HDR (High Dynamic Range) up to a resolution of 1920 x 1080. HDR can be experienced with streaming content like Netflix or via USB playback with supported video files. HDR will work on 1920 x 1080 resolution via USB and streaming, and with compatible HDMI 1.4a devices.

## Password in Parental Control

- The default password is 1234. You can change it to a new one.
- The super password is 0423. If you forget your code, enter the super password to override any existing codes.

## Problems & Solutions

**Note:** Problems & solutions 1 to 2 are for the TV models which have network functions, so users of non-connected TV models can disregard them.

### 1. Fail to link to the network.

- Check if your TV is connected with the network;
- Reboot your TV;
- Consult your internet service provider, to confirm if access of your router is supported. Refer to the operation manual of your router.
- Make sure your TV is connected to a router, and make sure your router is powered on. Check that your router/modem has an internet connection, and that your Ethernet cables/wireless connection is OK. Test your connection with a computer to make sure it is OK. Should the problem persist, contact customer service.

### 2. The video could not be played smoothly.

- Videos from your USB flash drive --- It may result from data transmission, or its code flow is far beyond the supported formats of this TV set.
- Videos downloaded from internet, or online videos.
  - a. It may be caused by the lower bandwidth of your network. A high network speed is required to handle online videos.
  - b. Peak internet usage times may affect the bandwidth.
  - c. Check if any other computers on the same network are also operating, as they may be using up bandwidth. Especially if they are downloading or playing on-line videos.
  - d. The video may not be smooth itself, it is not the problem of your TV or network.

**3. When two mobile hard disks are connected with the TV at the same time, they will not be recognized some times.**

- All mobile hard disks consume a lot of power, which may result in power supply problems. We recommend inserting only one hard disk, or a low power consumption mobile hard disk.

**4. The video from a mobile hard disk (USB) is playing with no sound.**

- The audio format of the video in your mobile hard disk is not supported by the TV player.

**5. Some videos fail to play.**

- The formats of the videos may not be supported by the TV, especially videos shot by certain kinds of cameras, generally with their private protocol of formats, which are not compatible with your TV.

**6. Video stops playing midway.**

- Mistakes may occur when videos are copied or compressed, so they may automatically stop playing during playback.

**7. What should I pay attention to, when I do SW updating?**

- No power cuts when SW updating;
- Avoid any operations with your remote control when SW updating;
- Depending on your internet connection speed, the software updating process may take some time.

**8. There are no distinct changes of TV interface after SW updating.**

- Under certain conditions, SW updating may not only update or add new functions but also improve the performance of the TV set, without distinct changes to the user interface. Also, there may be no changes to the user interface at all.

**9. What should I do when SW updating process stops due to a sudden power-off?**

- If you do SW updating by USB, do not pluck the USB from your TV, and restart your TV to continue SW updating; If you do SW updating by Network, also restart your TV and check if it is well functioned.

**10. With a USB device being inserted into the TV in advance, I am prompted that no USB devices are detected after I access Media, why?**

- There may be something wrong with your mobile hard disk(s), damaged or with low voltage. You could increase power supply by inserting the two plugs on one end on the USB wire into TV's USB port simultaneously.

### **11. External device cannot be recognized.**

- Some external devices (e.g. webcam, smart phone, tablet, game handle, and external wireless adapter) may not be compatible with the TV and cannot be supported for certain functions (nScreen, wireless display, gesture control, face recognition, if any). Please try a similar device. If it does not work, contact your local dealer.

### **12. Voice search does not work.**

- Check if your remote control has been successfully paired with your TV.
- Check if the language setting is correct.
- Check if Google server is available and stable.

## **Troubleshooting**

Most problems you encounter with your TV can be corrected by consulting the following troubleshooting list.

### **No picture, no sound**

1. Check if the fuse or circuit breaker is working.
2. Plug another electrical device into the outlet to make sure it is working or turned on.
3. Power plug is in a bad contact with the outlet.
4. Check the signal source.

### **No colour**

1. Change the colour system.
2. Adjust the saturation.
3. Try another channel. Black-white program may be received.

### **Remote control does not work**

1. Change the batteries.
2. Batteries are not installed correctly.
3. Main power is not connected.

### **No picture, normal sound**

1. Adjust the brightness and contrast.
2. Broadcasting failure may happen.

### **Normal picture, no sound**

1. Press the VOLUME UP button to increase volume.
2. Volume is set to mute, press the Mute button to restore sound.
3. Change the sound system.

4. Broadcasting failure may happen.

### **Unorderly ripples on the picture**

It is usually caused by local interference, such as cars, daylight lamps and hair driers. Adjust the antenna to minimize the interference.

### **Snowy dots and interference**

If the antenna is located in the fringe area of a television signal where the signal is weak, the picture may be marred by dots. When the signal is extremely weak, it may be necessary to install a special antenna to improve the reception.

1. Adjust the position and orientation of the indoor/ outdoor antenna.
2. Check the connection of antenna.
3. Fine tune the channel.
4. Try another channel. Broadcasting failure may happen.

### **Ignition**

Black spots or horizontal streaks appear, or the picture flutters or drifts. This is usually caused by interference from car ignition system, neon lamps, electric drills, or other electrical appliance.

### **Ghost**

Ghosts are caused by the television signal following two paths. One is the direct path, the other is reflected from tall buildings, hills, or other objects. Changing the direction or position of the antenna may improve the reception.

### **Radio frequency interference**

This interference produces moving ripples or diagonal streaks, and in some case, loss of contrast in the picture. Find out and remove the radio interference source.

\*To bring you better visual experience, please remove all labels, if any, from TV front panel and screen before use.

\*Figures and illustrations in this User Manual are provided for reference only and may differ from actual product appearance. Product design and specifications may be changed without notice.

#### **Warning**

This content is compiled from multiple sources and is provided for reference purposes only. It may not be complete or fully applicable to all situations. If you are unable to resolve your issue, please contact the product manufacturer or an authorized service provider for official support.