

PRODUCT DESCRIPTION

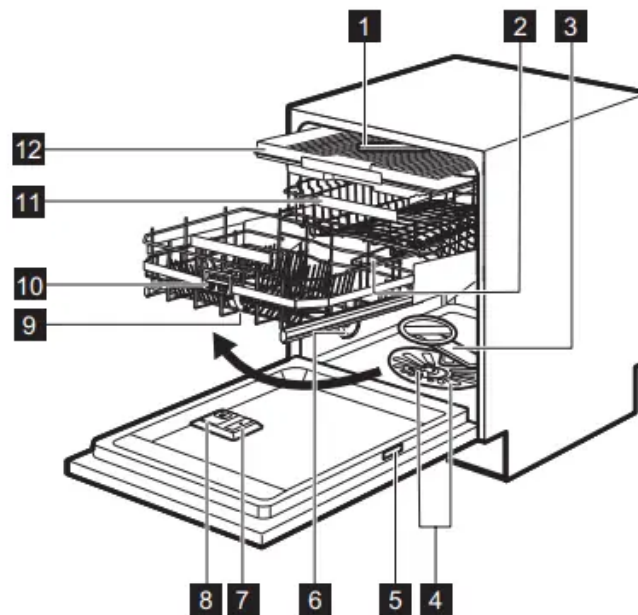

- | | |
|------------------------------|------------------------------|
| 1 Top spray arm | 8 Detergent dispenser |
| 2 Upper spray arm | 9 Comfort Lift basket |
| 3 Lower spray arm | 10 Release handle |
| 4 Filters | 11 Upper basket |
| 5 Rating plate | 12 Cutlery drawer |
| 6 Air vent | |
| 7 Rinse aid dispenser | |

Beam-on-Floor

The Beam-on-Floor is a light that is displayed on the floor below the appliance door.

- When the programme starts, a red light comes on and stays on for the duration of the programme.
- When the programme is completed, a green light comes on.
- When the appliance has a malfunction, the red light flashes.

CONTROL PANEL

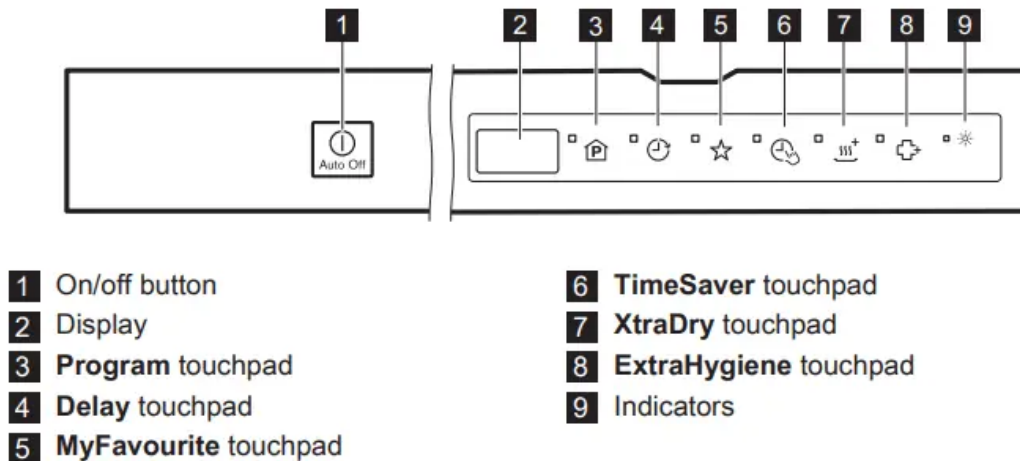

SETTINGS

Programme selection mode and user mode

When the appliance is in programme selection mode it is possible to set a programme and to enter the user mode.

Settings available in the user mode:

- The activation or deactivation of the rinse aid empty notification.
- The level of rinse aid according to the required dosage.
- Activation or deactivation of the acoustic signal for the end of a programme.
- The activation or the deactivation of the option AirDry.

As the appliance stores the saved settings, there is no need to configure it before every cycle.

How to set the programme selection mode







The appliance is in programme selection mode when the display shows the programme number P1.

After activation, the appliance is in programme selection mode by default. If not, set the programme selection mode the following way:

Press and hold simultaneously  and until the appliance is in programme selection mode.

How to enter user mode

Make sure the appliance is in programme selection mode.

To enter user mode, press and hold simultaneously  and  until the indicators , ,  and  flash and the display is blank.

The rinse aid empty notification

The rinse aid helps to dry the dishes without streaks and stains.

The rinse aid is automatically released during the hot rinse phase.





When rinse aid chamber is empty, the rinse aid indicator is turned on notifying to refill rinse aid. If the drying results are satisfactory while using multi-tablets only, it is possible to deactivate the notification for refilling rinse aid. However, for best drying performance, always use rinse aid.

If standard detergent or multi-tablets without rinse aid are used, activate the notification to keep the rinse aid refill indicator active.

How to deactivate the rinse aid empty notification

Make sure the appliance is in user mode.

1. Press .

- The indicators ,  and  are off.
- The indicator  still flashes.
- The display shows the current setting.

◦  = the rinse aid empty notification is deactivated.

▪  = the rinse aid empty notification is activated.

2. Press  to change the setting.

3. Press the on/off button to confirm the setting.

The rinse aid dispenser

The rinse aid helps to dry the dishes without streaks and stains.







The rinse aid is automatically released during the hot rinse phase.

It is possible to set the released quantity of rinse aid between level 1 (minimum quantity) and level 6 (maximum quantity). Level 0 deactivates the rinse aid dispenser and no rinse aid is released.

Factory setting: level 4

How to set the rinse aid level

Make sure the appliance is in user mode.

1. Press .
 - The indicators ,  and  are off.
 - The indicator  still flashes.
 - The display shows the current setting: e.g. **4A**= level 4.
 - The levels of rinse aid are from 0A to 6A where level 0A means rinse aid is not used.
2. Press  repeatedly to change the setting.
3. Press the on/off button to confirm the setting.







Acoustic signals

Acoustic signals sound when a malfunction of the appliance occurs. It is not possible to deactivate these acoustic signals.

There is also an acoustic signal that sounds when the programme is completed. By default this acoustic signal is deactivated but it is possible to activate it.

How to activate the acoustic signal for the end of programme

Make sure the appliance is in user mode.

1. Press .
 - The indicators ,  and  are off.
 - The indicator  still flashes.
 - The display shows the current setting.
 - **0b** = the acoustic signal is deactivated.
 - **1b** = the acoustic signal is activated.
2. Press  to change the setting.
3. Press the on/off button to confirm the setting.

AirDry

AirDry improves the drying results with less energy consumption.

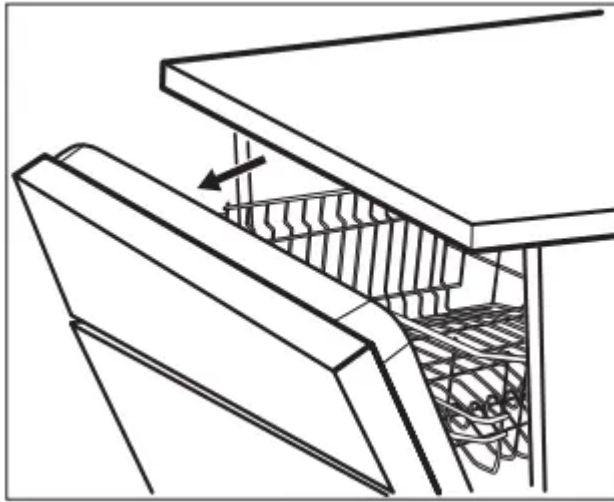

- While the drying phase operates, a device opens the appliance door. The door is then kept ajar.





AirDry is automatically activated with all programmes excluding Rinse & Hold

To improve the drying performance refer to the XtraDry option or activate AirDry.

How to deactivate AirDry

Make sure the appliance is in user mode.

1. Press .

- The indicators ,  and  are off.
- The indicator  still flashes.
- The display shows the current setting.

◦  = AirDry is deactivated.

◦  = AirDry is activated.

2. Press  to change the setting.

3. Press on/off to confirm the setting.

OPTIONS

- Desired options must be activated every time before you start a programme. It is not possible to activate or deactivate options while a programme is running.

- Not all options are compatible with each other. If you select non compatible options, the appliance automatically deactivates one or more of them. Only the indicators of the still active options are on.
- If an option is not applicable to a programme, the related indicator is off or it flashes quickly for a few seconds and then goes out.
- Activating options can affect the water and energy consumption as well as the programme duration.

XtraDry

Activate this option to boost the drying performance.

XtraDry is a permanent option for all programmes other than ECO. It is automatically activated in next cycles. This configuration can be changed at any time.

- Every time ECO is activated, XtraDry is off and needs to be chosen manually.

Activating XtraDry deactivates TimeSaver and vice versa.

How to activate XtraDry

Press .

The related indicator is on. The display shows the updated programme duration.

TimeSaver

The TimeSaver allows to reduce the duration of a selected programme by approximately 50%.

The washing results are the same as with the normal programme duration. The drying results can decrease.

This option increases the pressure and the temperature of the water. The washing and the drying phases are shorter.

By default, TimeSaver is off, but it is possible to activate it manually. This option cannot be combined with XtraDry.

How to activate TimeSaver

Press . The related indicator is on. The display shows the updated programme duration.

ExtraHygiene

This option provides better hygiene results by keeping the temperature at 70°C for at least 10 minutes during the last rinsing phase.

How to activate ExtraHygiene

Press  .

The related indicator is on.

The display shows the updated programme duration.

BEFORE FIRST USE

1. Fill the rinse aid dispenser.
2. Open the water tap.
3. Start a program to remove any processing residuals that can still be inside the appliance.
Do not use detergent and do not load the baskets.

How to fill the rinse aid dispenser

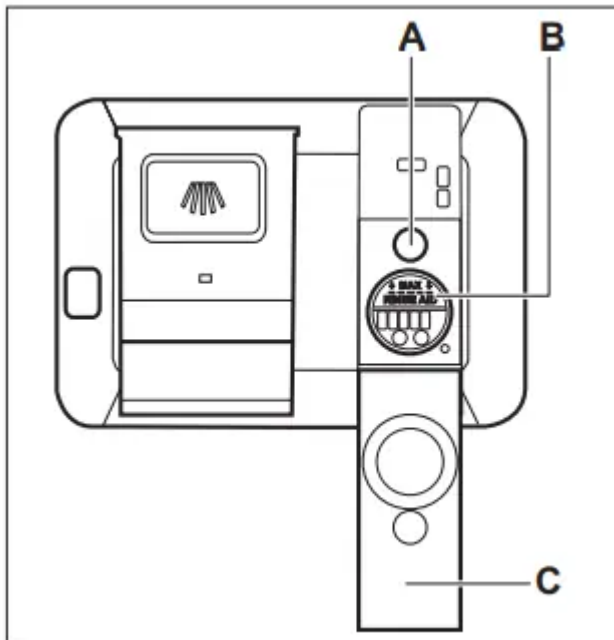

1. Open the lid (C).
2. Fill the dispenser (B) until the rinse aid reaches the marking "MAX".
3. Remove the spilled rinse aid with an absorbent cloth to prevent excessive foam formation.
4. Close the lid. Make sure that the lid locks into position.

DAILY USE

1. Open the water tap.
2. Press the on/off button to activate the appliance.

Make sure that the appliance is in programme selection mode.

- If the rinse aid empty message is shown fill the rinse aid dispenser.

3. Load the baskets.

4. Add the detergent.

5. Set and start the correct programme for the type of load and the degree of soil.

Comfort Lift

The Comfort Lift mechanism allows to lift the lower rack up (to the second rack level) and put it down to load and unload dishes easily.

To load or unload the lower basket:

1. Lift the basket by pulling the rack out of the dishwasher by the basket handle. The release handle should not be used.

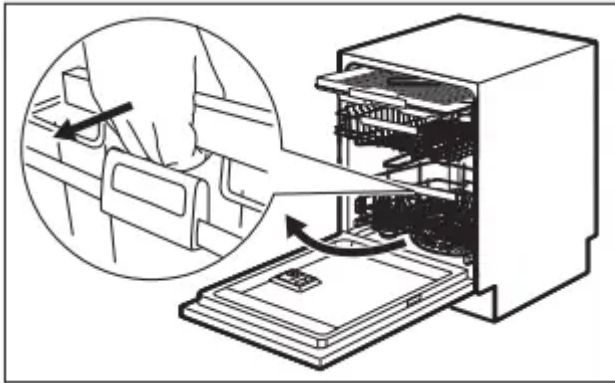

The basket is automatically locked on the upper level.

2. Carefully place items in the basket or remove them (refer to Basket loading leaflet).

3. Lower the basket by connecting the release handle with the basket frame as shown below. Lift the release handle completely and the basket handle slightly until the basket is disengaged on both sides.

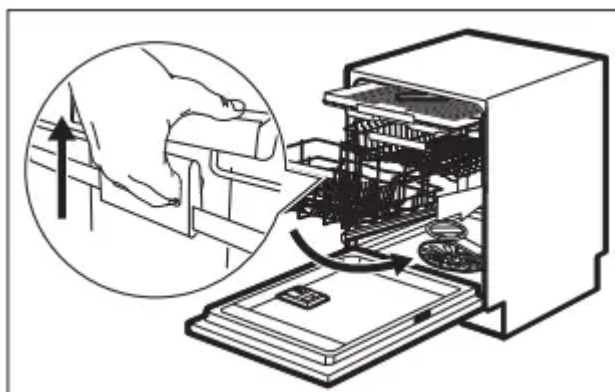

Once the basket is unlocked, push the rack down. The mechanism returns to its default position on the lower level.

There are two ways of lowering the basket depending on the loading:

- If there is a full load of plates, slightly push the basket down.
- If the basket is empty or half loaded, press the basket down.

Using the detergent

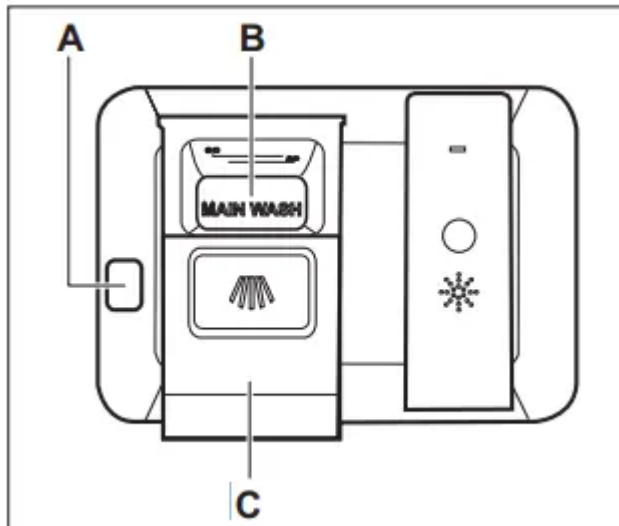

1. Press the release button (A) to open the lid (C).
2. Put the detergent, in powder or tablets, in the compartment (B).
3. If the programme has a prewash phase, put a small quantity of detergent on the inner part of the appliance door.
4. Close the lid. Make sure that the lid locks into position.

Setting and starting a programme

The Auto Off function



This function decreases energy consumption by deactivating automatically the appliance when it is not operating.

The function comes into operation:

- 5 minutes after the completion of the programme.
- After 5 minutes if the programme has not started.

Starting a programme

1. Keep the appliance door ajar.
2. Press the on/off button to activate the appliance. Make sure that the appliance is in programme selection mode.

3. Press repeatedly  until the display shows the number of the programme you want to start. The display will show the programme number for approximately 3 seconds and then show the programme duration.
 - If you want to select the MyFavourite programme, press 
 - The indicators of the options related to the MyFavourite programme come on.
4. Set the applicable options.
5. Close the appliance door to start the programme.

Starting a programme with delay start

1. Set a programme.
2. Press  again and again until the display shows the delay time you want to set (from 1 to 24 hours). The delay indicator comes on.
3. Close the appliance door to start the countdown.

While a countdown is running it is possible to increase the delay time but not to change the selection of the programme and options.

When the countdown is completed, the programme starts.



Opening the door while the appliance operates

Opening the door while a programme is running stops the appliance. It may affect the energy consumption and the programme duration. After closing the door, the appliance continues from the point of interruption.



- If the door is opened for more than 30 seconds during the drying phase, the running programme ends. It does not happen if the door is opened by AirDry function.

Cancelling the delay start while the countdown operates

When you cancel the delay start you have to set the programme and options again.

Press and hold simultaneously  and  until the appliance is in programme selection mode.

Cancelling the programme

Press and hold simultaneously  and  until the appliance is in programme selection mode.

Make sure that there is detergent in the detergent dispenser before you start a new programme.

End of programme

When the programme is completed and you open the door, the appliance is automatically deactivated.

Close the water tap.

HINTS AND TIPS

General

The following hints will ensure optimal cleaning and drying results in daily use and also help to protect the environment.

- Remove larger residues of food from the dishes into the waste bin.
- Do not pre-rinse dishes by hand. When needed, use the prewash programme (if available) or select a programme with a prewash phase.
- Always use the whole space of the baskets.
- When loading the appliance, make sure that the dishes can be completely reached and washed by the water released from the spray arm nozzles. Make sure that items do not touch or cover each other.
- You can use dishwasher detergent and rinse aid separately or you can use the multi-tablets. Follow the instructions written on the packaging.
- Select the programme according to the type of load and degree of soil. With the ECO programme you have the most efficient use of water and energy consumption for crockery and cutlery with normal soil.

Using rinse aid and detergent

- Only use rinse aid and detergent for dishwasher. Other products can cause damage to the appliance.
- Detergent tablets do not fully dissolve with short programs. To prevent detergent residues on the tableware, we recommend that you use the tablets with long programs.
- Do not use more than the correct quantity of detergent. Refer to the instructions on the detergent packaging.

Loading the baskets

- Only use the appliance to wash items that are dishwasher-safe.
- Do not put in the appliance items made of wood, horn, aluminium, pewter and copper.
- Do not put in the appliance items that can absorb water (sponges, household cloths).
- Remove remaining food from the items.
- Make soft the remaining burned food on the items.
- Put hollow items (cups, glasses and pans) with the opening down.
- Make sure that cutlery and dishes do not bond together. Mix spoons with other cutlery.
- Make sure that glasses do not touch other glasses.
- Put small items in the cutlery basket.
- Put light items in the upper basket. Make sure that the items do not move.

- Make sure that the spray arm can move freely before you start a programme.

Before starting a programme

Make sure that:

- The filters are clean and correctly installed.
- The spray arms are not clogged.
- There is dishwasher rinse aid (unless you use multi- tablets).
- The position of the items in the baskets is correct.
- The programme is applicable for the type of load and for the degree of soil.
- The correct quantity of detergent is used.

Unloading the baskets

1. For improved drying results with the most efficient use of energy select the AirDry option, otherwise open the door by approximately 10cm at the end of the program.
2. Allow the tableware to cool for 30 - minutes.
3. Hot items can be easily damaged, allow them to cool down before removing from appliance.
4. First remove items from the lower basket then the upper basket.

CARE AND CLEANING

Cleaning the filters

The filter system is made of 3 parts

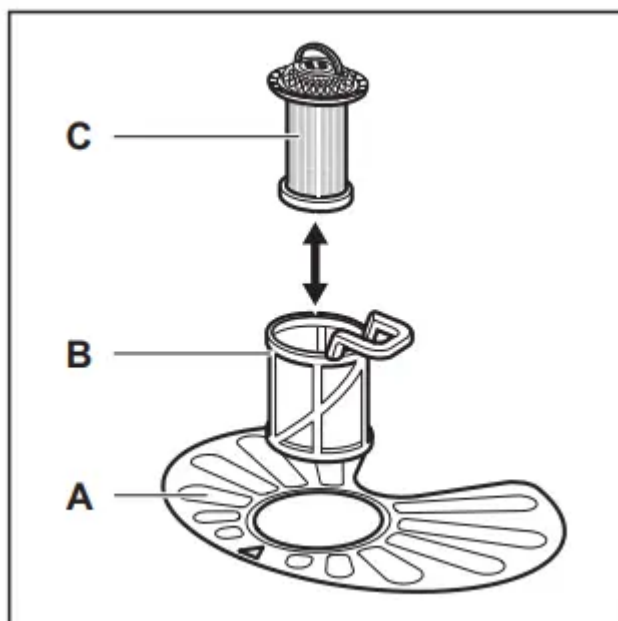

1. Turn the filter (B) counterclockwise and remove it.

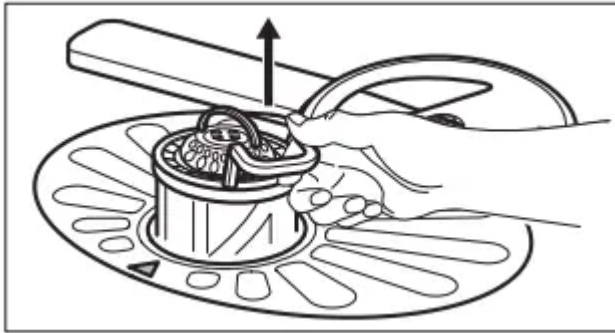
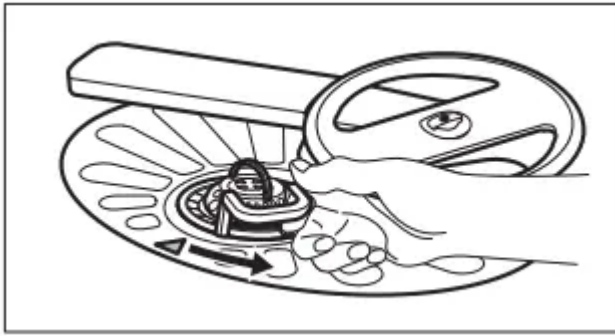

2. Remove the filter (C) out of filter (B).
3. Remove the flat filter (A).

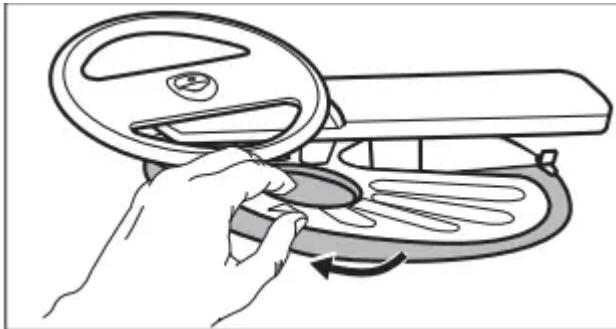

4. Wash the filters.

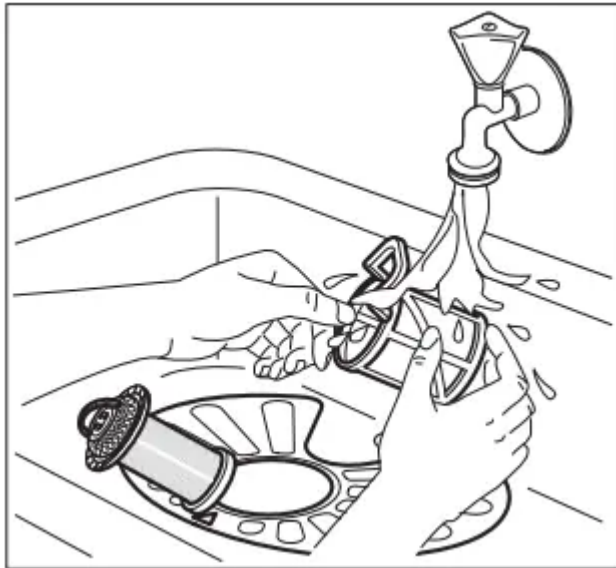

5. Make sure that there are no residues of food or soil in or around the edge of the sump.
6. Put back in place the flat filter (A). Make sure that it is correctly positioned under the 2 guides.

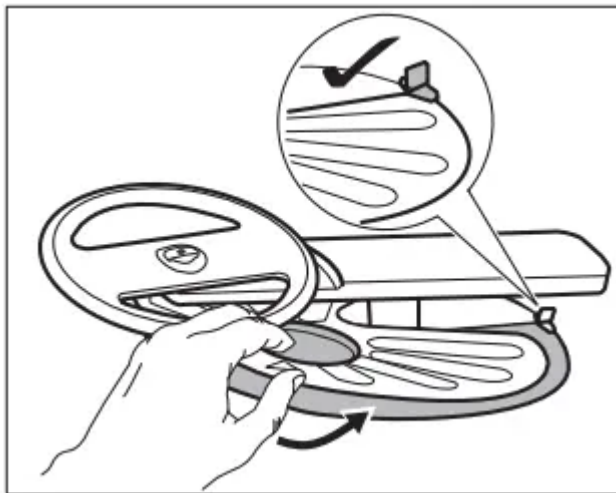

7. Reassemble the filters (B) and (C).
8. Put back the filter (B) in the flat filter (A). Turn it clockwise until it locks.

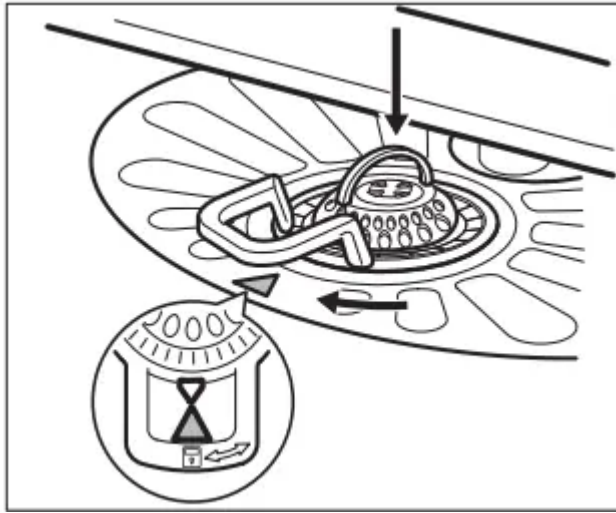

Cleaning the upper spray arm

We recommend to clean the upper spray arm regularly to prevent soil from clogging the holes. Clogged holes can cause unsatisfactory washing results.

1. Pull out the upper basket.
2. To detach the spray arm from the basket, press the spray arm upwards and simultaneously turn it clockwise.

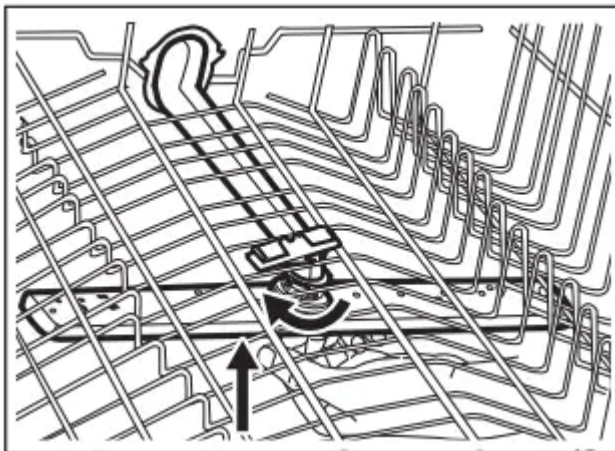

3. Wash the spray arm under running water. Use a thin pointed tool, e.g. a toothpick, to remove particles of soil from the holes.

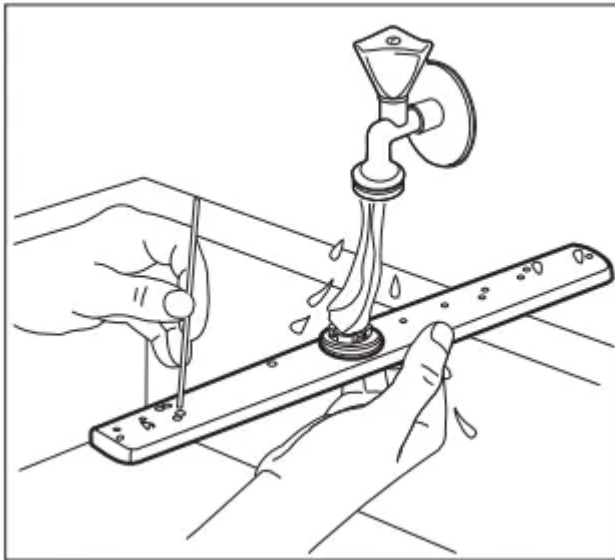

4. To install the spray arm back, press the spray arm upwards and simultaneously turn it counterclockwise until it locks into place.

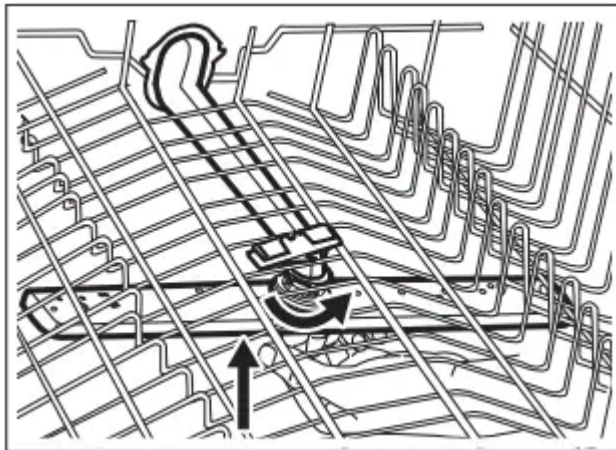

External cleaning

- Clean the appliance with a moist soft cloth.
- Only use neutral detergents.
- Do not use abrasive products, abrasive cleaning pads or solvents.

Internal cleaning



- Carefully clean the appliance, including the rubber gasket of the door, with a soft damp cloth.
- Do not use abrasive products, abrasive cleaning pads, sharp tools, strong chemicals, scourer or solvents.
- If you use short duration programmes regularly, these can leave deposits of grease and limescale inside the appliance. To prevent this, we recommend running long duration programmes at least twice a month.

- To maintain the performance of your appliance at its best, we recommend using a specific cleaning product for dishwashers (at least once a month). Follow carefully the instructions on the packaging of the product.

TROUBLESHOOTING

If the appliance does not start or it stops during operation. Before you contact an Authorised Service Centre, check if you can solve the problem by yourself with the help of the information in the table.

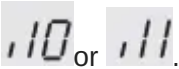
With some problems, the display shows an alarm code. The majority of problems that can occur can be solved without the need to contact an Authorised Service Centre.

Problem and alarm code	Possible solution
<p>You cannot activate the appliance.</p>	<ul style="list-style-type: none"> • Make sure that the mains plug is connected to the mains socket. • Make sure that there is no damaged fuse in the fuse box.
<p>The programme does not start.</p>	<ul style="list-style-type: none"> • Make sure that the appliance door is closed. • If the delay start is set, cancel the setting or wait for the end of the countdown
<p>The appliance does not fill with water. The display shows .</p>	<ul style="list-style-type: none"> • Make sure that the water tap is open. • Make sure that the pressure of the water supply is not too low. For this information, contact your local water authority. • Make sure that the water tap is not clogged. • Make sure that the filter in the inlet hose is not clogged. • Make sure that the inlet hose has no kinks or bends.
<p>The appliance does not drain the water. The display shows .</p>	<ul style="list-style-type: none"> • Make sure that the sink spigot is not clogged. • Make sure that the drain hose has no kinks or bends.
<p>The anti-flood device is on. The display shows .</p>	<p>Close the water tap and contact an Authorised Service Centre.</p>
<p>The appliance stops and starts more times during operation.</p>	<p>It is normal. It provides optimal cleaning results and energy savings.</p>
<p>The program lasts too long.</p>	<ul style="list-style-type: none"> • Select the TimeSaver option to shorten the program time (if applicable). • If the delayed start option is set, cancel the delay setting or wait for the end of the countdown.
	<p>This is not a defect. The appliance is working correctly.</p>

Problem and alarm code	Possible solution
The remaining time in the display increases and skips nearly to the end of program time	
The options of the program have to be set again every time.	To save your favourite configuration use option My- Favourite.
Small leak from the appliance door.	<ul style="list-style-type: none"> • The appliance is not levelled. Loosen or tighten the adjustable feet (if applicable). • The appliance door is not centred on the tub. Adjust the rear foot (if applicable).
The appliance door is difficult to close.	<ul style="list-style-type: none"> • The appliance is not levelled. Loosen or tighten the adjustable feet (if applicable). • Parts of the tableware are protruding from the baskets.
Rattling/knocking sounds from inside the appliance.	<ul style="list-style-type: none"> • The tableware is not properly arranged in the baskets. Refer to basket loading leaflet. • Make sure that the spray arms can rotate freely.
The appliance trips the circuit-breaker.	<ul style="list-style-type: none"> • The amperage is insufficient to supply simultaneously all the appliances in use. Check the socket amperage and the capacity of the meter or turn off one of the appliances in use. • Internal electrical fault of the appliance. Contact an Authorised Service Centre.
Poor washing results.	<ul style="list-style-type: none"> • Refer to "Daily use", "Hints and tips" and basket loading leaflet. • Use more intensive washing programmes. • Clean spray arm jets and filter. Refer to "Care and Cleaning".
Poor drying results.	

Problem and alarm code	Possible solution
	<ul style="list-style-type: none"> • Tableware has been left for too long inside a closed appliance. • There is no rinse aid or the dosage of rinse aid is not enough. Set the rinse aid dispenser to a higher level. • Plastic items may need to be towel dried. • For the best drying performance activate the option XtraDry and set AirDry. • We recommend to always use rinse aid, even in combination with multi-tablets.
<p>There are whitish streaks or bluish layers on glasses and dishes.</p>	<ul style="list-style-type: none"> • The release quantity of rinse aid is too much. Adjust the rinse aid level to a lower level. • The quantity of detergent is too much.
<p>There are stains and dry water drops on glasses and dishes.</p>	<ul style="list-style-type: none"> • The released quantity of rinse aid is not sufficient. Adjust the rinse aid level to a higher level. • The quality of the rinse aid can be the cause.
<p>The dishes are wet.</p>	<ul style="list-style-type: none"> • For the best drying performance activate the option XtraDry and set AirDry . • The programme does not have a drying phase or has a drying phase with low temperature. • The rinse aid dispenser is empty. • The quality of the rinse aid can be the cause. • The quality of the multi-tablets can be the cause. Try a different brand or activate the rinse aid dispenser and use rinse aid and multi-tablets together.
<p>The interior of the appliance is wet.</p>	<p>This is not a defect of the appliance. it is caused by the humidity in the air that condenses on the walls.</p>

Problem and alarm code	Possible solution
Unusual foam during washing.	<ul style="list-style-type: none"> • Use the detergent for dishwashers only. • There is a leak in the rinse aid dispenser. Contact an Authorised Service Centre.
Traces of rust on cutlery.	Silver and stainless steel cutlery were placed together. Avoid to put silver and stainless steel items close together.
There are residues of detergent in the dispenser at the end of the programme.	<ul style="list-style-type: none"> • The detergent tablet got stuck in the dispenser and therefore was not completely washed away by water. • Water cannot wash away the detergent from the dispenser. Make sure that the spray arm is not blocked or clogged. • Make sure that items in the baskets do not impede the lid of the detergent dispenser from opening.
Limescale deposits on the tub and on the inside of the door.	<ul style="list-style-type: none"> • Clean the appliance with appliance cleaners which are particularly suitable for this purpose. • Try different detergent. • Contact the detergent manufacturer.
Odours inside the appliance.	Refer to "Internal cleaning".
Dull, discoloured or chipped tableware.	<ul style="list-style-type: none"> • Make sure that only dishwasher-safe items are washed in the appliance. • Load and unload the basket carefully. Refer to basket loading leaflet. • Place delicate items in the upper basket.

Warning

This content is compiled from multiple sources and is provided for reference purposes only. It may not be complete or fully applicable to all situations. If you are unable to resolve your issue, please contact the product manufacturer or an authorized service provider for official support.

