

INSTALLING YOUR DRYER

UNPACKING YOUR DRYER

Unpack your dryer and inspect it for shipping damage. Make sure you have received all of the items shown below. If your dryer was damaged during shipping, or you do not have all of the items, contact 1-800-SAMSUNG (726-7864).

To prevent personal injury or strain, wear protective gloves whenever lifting or carrying the dryer.



Packing materials can be dangerous to children. Keep all packing material (plastic bags, polystyrene, etc.) well out of children's reach.



Do not move the product while holding the front part of the top cover of the dryer.

- This may cause the cover to be separated and result in injury.

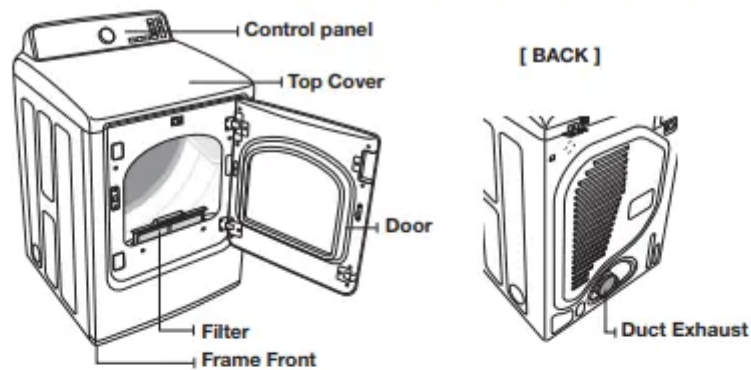

Tools needed



Pliers



Cutting knife



Pipe wrench (gas only)



Nut drivers



Level



Phillips Screwdriver



Duct tape



Wrench

Parts supplied (DV48(5)H7400E(G)* ONLY)



"Y"- Connector



Hose water



Short inlet hose

BASIC REQUIREMENTS



Make sure you have everything necessary for proper installation

- A GROUNDED ELECTRICAL OUTLET is required. See Electrical Requirements.
- A POWER CORD for electric dryers (except in Canada).

- GAS LINES (if installing a gas dryer). The gas lines must meet national and local codes.
- EXHAUST SYSTEM - must be rigid metal or flexible stiff-walled metal exhaust ducting.

DUCTING REQUIREMENTS

- Use a 4-inch (10.2 cm) diameter rigid aluminum or rigid galvanized steel duct.
- Do not use a smaller duct.
- Ducts larger than 4 inches (10.2 cm) in diameter can cause increased lint accumulation. Lint accumulation should be cleaned regularly.
- If a flexible metal duct must be used, use the type with a stiff sheet metal wall. Do not use a flexible duct with a thin foil wall. Serious blockage can result if the flexible metal duct is bent too sharply.
- Never install any type of flexible duct in walls, ceilings, or other concealed spaces.
- Keep the exhaust duct as straight and short as possible.
- Secure joints with duct tape. Do not use screws.
- Plastic flexible ducts can kink, sag, be punctured, reduce airflow, extend drying times, and affect dryer operation.
- Exhaust systems longer than recommended can extend drying times, affect machine operation, and may collect lint.
- The exhaust duct should end with an exhaust hood with a swing-out damper to prevent back drafts and the entry of wildlife. Never use an exhaust hood with a magnetic damper.
- The hood should have at least 12 inches (30.5 cm) of clearance between the bottom of the hood and the ground or other obstruction. The hood opening should point down.
- Never install a screen over the exhaust outlet.
- To avoid lint buildup, do not exhaust the dryer directly into a window well. Do not exhaust under a house or porch.
- If exhaust ductwork must run through an unheated area, the duct should be insulated and slope slightly down towards the exhaust hood to reduce condensation and lint buildup.
- Inspect and clean the interior of the exhaust system at least once a year. Unplug the power cord before cleaning.
- Check frequently to be sure the exhaust hood damper opens and closes freely.
- Check once per month, and clean at least one time per year. Note: If clothes are not getting dry, then check to the duct for obstructions.
- Do not exhaust the dryer into any wall, ceiling, crawl space, or concealed space of a building, gas vent, or any other common duct or chimney. This could create a fire hazard from lint expelled by the dryer.

| ELECTRIC AND GAS DRYER | | | | |
|---|-----------------|--------------------|--|--------------------|
| Weather Hood Type | | | | |
| Recommended | | | Use only for short-run installation | |
|  4" (10.2 cm) | | |  2.5" (6.4 cm) | |
| No. of 90° elbows | Rigid | Metallic Flexible* | Rigid | Metallic Flexible* |
| 0 | 80 ft. (24.4 m) | 41 ft. (12.4 m) | 74 ft. (22.6 m) | 33 ft. (10.1 m) |
| 1 | 68 ft. (20.7 m) | 37 ft. (11.2 m) | 62 ft. (18.9 m) | 29 ft. (8.8 m) |
| 2 | 57 ft. (17.4 m) | 33 ft. (10.1 m) | 51 ft. (15.5 m) | 25 ft. (7.6 m) |
| 3 | 47 ft. (14.3 m) | 29 ft. (8.8 m) | 41 ft. (12.5 m) | 21 ft. (6.5 m) |

- Do not use a non-metallic flexible duct.

If the new dryer is being installed into an existing exhaust system, you must make sure:

- The exhaust system meets all local, state, and national codes.
- That a flexible plastic duct is not used.
- Inspect and clean all lint buildup from inside the existing duct.
- The duct is not kinked or crushed.
- The exhaust hood damper opens and closes freely.

The static pressure in any exhaust system must not exceed 0.83 inches of the water column, or be less than 0. This can be measured with the dryer running with a manometer at the point where the exhaust duct connects to the dryer. A no-heat setting should be used. The dryer tumbler should be empty and the lint filter clean.

IMPORTANT TO INSTALLER

Please read the following instructions carefully before installing the dryer. These instructions should be kept for future reference.



Remove the door from all discarded appliances to avoid the danger of a child suffocating.

LOCATION CONSIDERATIONS

Locate the dryer where there is enough space at the front for loading the dryer, and enough space behind for the exhaust system. This dryer is factory-ready for rear exhaust. To exhaust out the bottom of the right or the left (electric model only), use the accessory exhaust kit (sold separately). Instructions are included with the kit. It's important to make sure the room has enough fresh air. The dryer must be located where there is no air-flow obstruction.

On gas dryers, adequate clearance as noted on the data plate must be maintained to ensure adequate air for combustion and proper dryer operation.

Do not install or store the dryer in an area where it will be exposed to water and/or weather. Keep the dryer area clear of combustible materials, gasoline, and other flammable vapors and liquids. A dryer produces combustible lint. The area around the dryer should be kept lint-free.

ALCOVE OR CLOSET INSTALLATION



You must exhaust the dryer to the outside to reduce the risk of fire when you install the dryer in an alcove or closet.

- No other fuel-burning appliance should be installed in the same closet as the dryer.
- **WARNING:** To reduce the risk of fire, you must exhaust the dryer outdoors. See the Exhaust information section.
- Minimum clearances between the dryer and adjacent walls or other surfaces are 2" in front, 17" on top, 1" on either side, and 5" in the back.
- The closet front must have two unobstructed air openings for a combined minimum total area of 72 in² with 3" minimum clearance on the top and bottom. A louvered door with equivalent space clearance is acceptable.

MOBILE HOME INSTALLATION

The installation of the dryer in mobile homes must conform to the Manufactured Home Construction and Safety Standard Title 24 CFR, Part 3280 {formerly the Federal Standard for Mobile Home Construction and Safety, Title 24, HUD (Part 280), 1975} for the United States) or CSA Standards Z240 (for Canada). When installing a dryer in a mobile home, you must make provisions for anchoring the dryer to the floor. Locate the dryer in an area that has adequate fresh air.

A minimum of 72 in² (465 cm²) of unobstructed space is required.

Call 1-800-SAMSUNG(726-7864) for information on purchasing the Floor Anchoring Kit as an accessory.

All mobile home installations must be exhausted to the outside with the exhaust duct termination securely fastened to the mobile home structure, using materials that will not support combustion. The exhaust duct may not terminate underneath the mobile home. See the Exhausting section for more information.

EXHAUSTING

The dryer shall not be exhausted into a chimney, a wall, a ceiling, an attic, a crawl space, or a concealed space of a building.

Exhausting the dryer to the outside will prevent a large amount of lint and moisture from being blown into the room.

In the United States:

- All dryers must be exhausted to the outside.
- The required exhaust duct is 4 inches (10.2 cm) in diameter.

- Use only those foil-type flexible ducts, if any, specifically identified for use with the appliance by the manufacturer and that comply with the Outline for Clothes Dryer Transition Duct, Subject 2158A shall be used.
- See “Ducting Requirements” in installing your dryer section for the maximum duct length and number of bends that shall be used.
- The total length of the flexible metal duct shall not exceed 2.4 m.
- Do not assemble the duct with screws or other fastening means that extend into the duct and catch lint.

In Canada:

- All dryers must be exhausted to the outside.
- The exhaust duct should be 4 inches(10.2 cm) in diameter.
- Use only those foil-type flexible ducts, if any, specifically identified ed for use with the appliance by the manufacturer shall be used.
- See “Ducting Requirements” in installing your dryer section for the maximum duct length and number of bends.
- The total length of the flexible metal duct shall not exceed 2.4 m.
- Do not assemble the duct with screws or other fastening means that extend into the duct and catch lint

Outside the U.S. and Canada:

- Refer to the local codes.



You must exhaust the dryer to the outside to reduce the risk of fire when you install the dryer in an alcove or closet.

NEVER USE A PLASTIC OR NON-METAL FLEXIBLE DUCT.

If your existing ductwork is plastic, non-metal, or combustible, replace it with metal. Use only a meta exhaust duct that is non-flammable to ensure the containment of exhaust air, heat, and lint.

GAS REQUIREMENTS

Use only natural or LP (liquid propane) gases.

THE INSTALLATION MUST CONFORM WITH LOCAL CODES, OR IN THE ABSENCE OF LOCAL CODES, WITH THE NATIONAL FUEL GAS CODE ANSI/Z223.1, THE LATEST REVISION (FOR THE UNITED STATES), OR WITH THE CAN/CGA-B149 INSTALLATION CODES (FOR CANADA).

Gas dryers are equipped with a burner vent for use with natural gas. If you plan to use your dryer with LP (liquid propane) gas, it must be converted for safe and proper performance by a qualified service technician. A 1/2” (1.27 cm) gas supply line is recommended and must be reduced to



connect to the 3/8" (1 cm) gas line on your dryer. The National Fuel Gas Code requires that an accessible, approved manual gas shut-off valve be installed within 6" of your dryer.

Gas dryers installed in residential garages must be raised 18 inches (46 cm) above the floor.

Additionally, a 1/8" (0.3 cm) N.P.T. (National Pipe Thread) plugged tapping, accessible for test gauge connection, must be installed immediately upstream of your dryer's gas supply connection. Your dryer must be disconnected from the gas supply pipe system during any pressure testing of the system.

DO NOT reuse old flexible metal gas lines. Flexible gas lines must be design certified by the American Gas Association (CGA in Canada).

- Any pipe joint compound used must be resistant to the action of any liquefied petroleum gas.
- As a courtesy, most local gas utilities will inspect a gas appliance installation.

GAS IGNITION – Your dryer uses an automatic ignition system to ignite the burner. There is no constant burning pilot.

COMMONWEALTH OF MASSACHUSETTS INSTALLATION INSTRUCTIONS

Your dryer must be installed by a licensed plumber or gas fitter. A "T" handle manual gas valve must be installed in the gas supply line to your dryer. If a flexible gas connector is used to install your dryer, the connector can be no longer than 3' (36").



- Gas leaks may occur in your system, creating a dangerous situation.
- Gas leaks may not be detected by smell alone.
- Gas suppliers recommend you purchase and install a UL-approved gas detector.
- Install and use in accordance with the manufacturer's instructions.

ELECTRICAL REQUIREMENTS

The Wiring diagram is located on the plate below the control panel or frame back.



- Improperly connecting the equipment grounding conductor can result in a risk of electric shock. Check with a qualified electrician or serviceman if you are in doubt as to whether your dryer is properly grounded. Do not modify the plug provided with your dryer – if it doesn't fit the outlet, have a proper outlet installed by a qualified electrician.
- To prevent unnecessary risk of fire, electrical shock, or personal injury, all wiring and grounding must be done in accordance with local codes, or in the absence of local codes, with the National Electrical Code, ANSI/NFPA No. 70-Latest Revision (for the

U.S.) or the Canadian Electrical Code CSA C22.1 – Latest Revisions and local codes and ordinances. It is your responsibility to provide adequate electrical services for your dryer.

- All gas installations must be done in accordance with the National Fuel Code ANSI/ Z2231 – Latest Revision (for the U.S.) or CAN/CGA – B149 Installation Codes – Latest Revision (for Canada) and local codes and ordinances.

GROUNDING

This dryer must be grounded. In the event of malfunction or breakdown, the ground will reduce the risk of electrical shock by providing a path of least resistance for the electrical current.



Gas models

Your dryer has a cord with an equipment-grounding conductor and a grounding plug.

The plug must be plugged into an appropriate outlet that is properly installed and grounded in accordance with all local codes and ordinances.

Do not modify the plug provided with your dryer – if it doesn't fit the outlet, have a proper outlet installed by a qualified electrician.

Never connect the ground wire to plastic plumbing lines, gas lines, or hot water pipes.



Electric models

Your dryer has an optional cord with an equipment-grounding conductor and a grounding plug, This cord is sold separately. The plug must be plugged into an appropriate outlet that is properly installed and grounded in accordance with all local codes and ordinances. Do not modify the plug provided with your dryer – if it doesn't fit the outlet, have a proper outlet installed by a qualified electrician. If a power cord is not used and the electric dryer is to be permanently wired, the dryer must be connected to a permanently grounded metal wiring system, or an equipment grounding conductor must be run with the circuit conductors and connected to the equipment grounding terminal or lead on the dryer.

ELECTRICAL CONNECTIONS

Before operating or testing, follow all grounding instructions in the Grounding section.

An individual branch (or separate) circuit serving only your dryer is recommended. **DO NOT USE AN EXTENSION CORD.**

Gas models – U.S. and Canada

A 120-volt, 60 Hz AC-approved electrical service, with a 15-ampere fuse or circuit breaker is required.

Electric models – U.S. Only

Most U.S. dryers require a 120 / 240 volt, 60 Hz AC-approved electrical service. Some require 120 / 208 volt, 60 Hz approved electrical service. The electric service requirements can be found on the data label located behind the door. A 30-ampere fuse or circuit breaker on both sides of the line is required.

- If a power cord is used, the cord should be plugged into a 30-ampere receptacle.
- The power cord is NOT provided with U.S. electric model dryers.



Risk of Electric Shock

When local codes allow, the dryer electrical supply may be connected by means of a new power supply cord kit, marked for use with a dryer, that is U.L. listed and rated at a minimum of 120/240 volts, 30-ampere with three No. 10 copper wire conductors terminated with closed-loop terminals, open-end spade lugs with turned-up ends, or with tinned leads.

- Do not reuse a power supply cord from an old dryer. The power cord electric supply wiring must be supported at the dryer cabinet by a suitable UL-listed strain relief.
- Grounding through the neutral conductor is prohibited for (1) new branch-circuit installations, (2) mobile homes, (3) recreational vehicles, and (4) areas where local codes prohibit grounding through the neutral conductor. (Use a 4-prong plug for a 4-wire receptacle, NEMA type 14-30R.)

Electric models – Canada Only

- A 120 / 240 volt, 60 Hz AC-approved electrical service fused through a 30-ampere fuse or circuit breaker on both sides of the line is required.
- All Canadian models are shipped with the power cord attached. The power cord should be plugged into a 30-ampere receptacle. It is not permissible to convert a dryer in Canada to 208 volts.

INSTALLATION - GENERAL PROCEDURE

For proper installation, we recommend that you hire a qualified installer.

Read these instructions completely before you begin the installation.

To install the dryer, follow these steps:

1. Move your dryer to an appropriate location for installation. Consider installing the dryer and washer side-by-side so you have easy access to both appliances.



To move the dryer easily, lay two of the carton cushion tops on the floor. Tip your dryer on its side so it lies across both cushion tops. Push the dryer so that it is near its final location. Set your dryer upright. Leave enough room around the dryer so you can attach the ductwork, power cord, etc.

2. If you need to change the direction of the door, go to Door Reversal on page 19. When done, return to Step 3 below.

3. Review the Exhausting section before installing the exhaust system. Install the ductwork from your dryer to the exhaust hood. The crimped end of the duct sections must point away from your dryer. DO NOT use sheet metal screws when assembling ducting. These joints should be taped. Never use plastic flexible exhaust material.



A tip for tight installations: Attach a section of the exhaust system to your dryer before putting it in place. Use duct tape to secure this section to your dryer, but do not cover the ventilation slots at the back of the dryer cabinet.

4. If you have an electric model, skip to Step 6. If you have a gas model, go to the next step.

5. Review the Gas Requirements section, then follow the lettered steps below

a. Remove the pipe thread protective cap.

b. Apply pipe joint compound or about 1 1/2 wraps of Tefl on tape over all threaded connections.



The pipe joint compound must be resistant to the action of any liquefied petroleum gas.

c. Connect the gas supply to your dryer. An additional fitting is required to connect the 3/4" (1.9 cm) female thread end of a flexible connector to the 3/8" (1 cm) male threaded end on the dryer.

d. Securely tighten the gas line fitting over the threads.

e. Turn on the gas supply. Check all gas connections for leaks using a soap solution. If bubbles appear, tighten the connections and recheck. DO NOT use an open flame to check for gas leaks.

f. Go to Step 6 on the next page

6. Review the Electrical Requirements section, then follow the 3 Wire system connection instructions (Step 7) or 4 Wire system instructions (Step 8) below.

7. Three Wire system instructions:

A. External ground connector

B. Neutral grounding wire (white)

C. Center silver-colored terminal block screw

D. Neutral wire (white or center wire)

E. 3/4" (1.9 cm) UL-listed strain relief

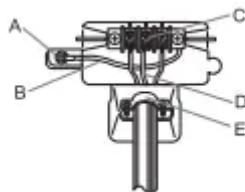

1. Loosen or remove the center terminal block screw.
2. Connect the neutral wire (white or center wire) of the power cord to the center, silver-colored terminal screw of the terminal block. Tighten screw.
3. Connect the other wires to the outer terminal block screws. Tighten screws.
4. Tighten the strain relief screws.
5. Insert the tab of the terminal block cover into your Dryer's rear panel slot. Secure the cover with a hold-down screw.



If converting from a 4-wire electrical system to a 3-wire, you must connect the ground strap to the terminal block support to ground the dryer frame to the neutral conductor.



We recommend using Ring terminals. If you use Strap terminals, please ensure you install them perfectly.

8. Four Wire System instructions:

- A. External ground connector
- B. Green or bare copper wire of power cord
- C. $\frac{3}{4}$ " (1.9 cm) UL-listed strain relief
- D. Center silver-colored terminal block screw
- E. Neutral Grounding wire (white)
- F. Neutral wire (white or center wire)

1. Remove the External ground connector screw.
2. Connect the ground wire (green or unwrapped) of the power cord to the external ground connector screw. If you want to connect B (Green or bare copper wire of power cord) to the Neutral Post without connecting it to A (cabinet ground), call a service technician.
3. Loosen or remove the center terminal block screw.
4. Connect the neutral wire (white or center wire) of the power cord and the appliance ground wire (green with yellow stripes) under the central screw of the terminal block.
5. Connect the other wires to the outer terminal block screws. Tighten screws.
6. Tighten the strain relief screws.

7. Insert the tab of the terminal block cover into your Dryer's rear panel slot. Secure the cover with a hold-down screw.

 We recommend using Ring terminals. If you use Strap terminals, please ensure you install them perfectly.

U.S. MODELS:

 Risk Of Electric Shock

All U.S. models are designed for a 3-WIRE SYSTEM CONNECTION. The dryer frame is grounded to the neutral conductor at the terminal block. A 4-WIRE SYSTEM CONNECTION is required for new or remodeled construction, mobile homes, or if local codes do not permit grounding through neutral. If you use the 4-wire system, you cannot ground the dryer frame to the neutral conductor at the terminal block.

Remove the terminal block cover plate. Insert the power cord with a UL-listed strain relief through the hole provided in the cabinet near the terminal block.

A strain relief must be used. Do not loosen the nuts already installed on the terminal block. Be sure they are tight. Use a 3/8" (1cm) deep well socket.

9. To ensure that the dryer provides optimal drying performance, it must be level. To level the dryer, follow the lettered steps below:

- Using a level, check if the dryer is level side to side and then front to back.
- If the dryer is not level, adjust the leveling feet on the bottom of the dryer until the dryer is level side to side and back to front. Turning the feet clockwise retracts the feet. Turning the feet clockwise loosens and extends them.



If you have a dryer and washer

 To set the dryer to the same height as the washer, fully retract the leveling feet by turning them counterclockwise, then loosen the feet by turning them clockwise. Once the dryer is the same height as the washer, follow the directions above to level the dryer.

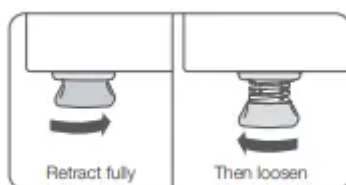

Adjust the leveling feet only as much as necessary to level the dryer. Extending the leveling feet more than necessary can cause the dryer to vibrate.



10. Make sure all gas connections (on gas models) and exhaust, and electrical connections are complete. Plug in your dryer, and then check its operation by using the checklist on the next page.

11. For GAS MODELS ONLY

The burner may not ignite initially due to air in the gas line. Allowing your dryer to operate on a heat setting will purge the line. If the gas does not ignite within 5 minutes, turn your dryer off and wait 5 minutes. Be sure the gas supply to your dryer has been turned on. To confirm gas ignition, check the exhaust for heat.

METHOD1



The dryer must be connected to the cold water faucet using the new inlet hoses. Do not use old hoses.

1. If space permits, attach the brass female end of the “Y” connector to the cold water faucet.
2. Turn the cold water faucet off.
3. Attach the straight end of the long hose to the “Y” connector.
4. Using pliers, tighten the coupling with an additional two-thirds turn.  Do not overtighten, as it may damage the coupling.
5. Attach the angled end of long hoses to fill the valve at the bottom of the dryer’s rear frame. Screw on the coupling by hand until it is seated on the fill valve connector.
6. Using pliers, tighten the coupling with an additional two-thirds turn.  Do not overtighten, as it may damage the coupling.
7. Check that the water faucets are on.
8. Check for leaks around “Y” connectors, faucets, and hoses.



METHOD2

The dryer must be connected to the cold water faucet using the new inlet hoses. Do not use old hoses.

1. If the “Y” connector cannot be attached directly to the cold water faucet, the short hose must be used.
2. Turn the cold water faucet off.
3. Attach a short inlet hose to the cold water faucet. Screw on the coupling by hand until it is seated on the faucet.
4. Using pliers, tighten the coupling with an additional two-thirds turn.  Do not overtighten, as it may damage the collar.
5. Attach the ‘Y” connector to the brass male end of the small hose. Screw on the coupling by hand until it is seated on the connector.
6. Using pliers, tighten the coupling with an additional two-thirds turn.  Do not overtighten, as it may damage the collar.
7. Attach the angled end of long hoses to the fill valve at the bottom of the rear dryer frame. Screw on the coupling by hand until it is seated on the fill valve connector.
8. Using pliers, tighten the coupling with an additional two-thirds turn.  Do not overtighten, as it may damage the collar.
9. Check that the water faucets are on.
10. Check for leaks around “Y” connectors, faucets, and hoses.

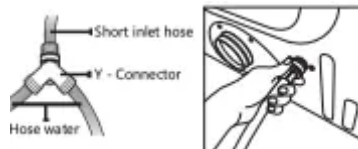

FINAL INSTALLATION CHECKLIST

- The dryer is plugged into an electrical outlet and grounded properly.
- The exhaust ductwork is hooked up and the joints are taped.
- You have used rigid or stiff-walled flexible metal duct material, not plastic flexible duct.
- The dryer is level and is sitting firmly on the floor.
- For gas models: The gas is turned on and there are no gas leak

DRYER EXHAUST TIPS



Plastic or non-metal flexible duct presents a potential fire hazard.

1. Make sure your dryer is installed properly so it exhausts air easily.

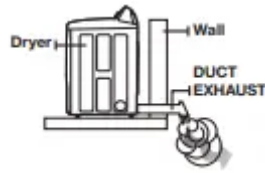

2. Use a 4" diameter rigid metal duct. Tape all joints, including at the dryer. Never use lint-trapping screws.

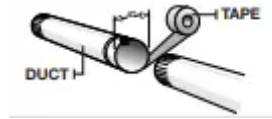

3. Keep ducts as straight as possible.

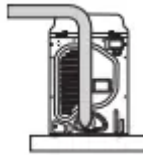

4. Clean all old ducts before installing your new dryer. Be sure the vent flap opens and closes freely. Inspect and clean the exhaust system annually.

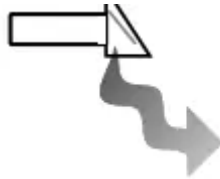

Don't let a poor exhaust system slow drying by:

1. Restricting your dryer with a poor exhaust system.
2. Using a plastic, thin foil, or non-metal flexible duct.
3. Using unnecessarily long ducts that have many elbows.
4. Using crushed or clogged venting or ducts.

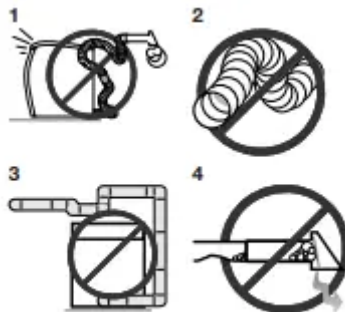

VENT BLOCKAGE TEST

After the dryer is installed, start the Vent Blockage Test to check if the duct system is properly installed. The Vent Blockage Test automatically detects the status of the ducts and reports any blockage or problems. Proper ducting can reduce drying time and save energy.



The Vent Blockage Test must run with the dryer in a cool state. If the dryer warms up after the installation check, run the AIR FLUFF cycle for several minutes to reduce its internal temperature.

Running the vent blockage test

1. Make sure the drum is empty, and then close the door. (If there are any clothes or other items in the drum, the test will not give accurate results.)
2. Press the POWER button to turn the dryer on, then simultaneously press and hold the Adjust Time  and Dry level buttons for 3 seconds. “InS or In” appears in the dryer’s display. (If you have started other procedures before the Vent Blockage Test, the dryer will not enter the Vent Blockage Test mode.)
3. Press the START/PAUSE button. The Vent Blockage Test starts immediately. During the test, the number indicator makes a circle in 6 clockwise steps. The test takes about 2 minutes. Do not open the door during the test.
4. After 2 minutes, when the test is complete, the results are displayed and the dryer sounds a tone.

If the status of the duct system is normal, “End or 0” appears and the dryer sounds a completion tone.

If the duct system can not exhaust properly, “CLg or Cg” appears and the dryer sounds an alarm tone.

If there are any other problems, an information code appears in the display. For information about the code, see the “Information codes” section on page 32.

- To stop or cancel the Vent Blockage Test, press the POWER button to turn off your dryer.
- During the test, if “dE” appears in the display, make sure the door is closed. If “C1” is displayed, see if there is laundry inside the drum. If there is, stop the test and remove it. Then, start the test again.
- The results remain on the display for about 5 minutes and then automatically turn off. You can turn the result off immediately by pressing the POWER button.
- During or after the test, the internal drum is hot. Use caution to prevent burns. The Vent Blockage Test is used to check for problems with the current duct system when the dryer is installed for the first time.
- If the test result displays “CLg or Cg” (the duct system is blocked), refer to the “Ducting requirements” section on page 8 and the “Exhaust ducting guide” section below, and then take proper measures to correct any problems. If the test is suspended, it could result in incorrect results. Follow the proper procedures when testing the dryer.

- Even if the test result is normal (“End or 0”), the duct system could be blocked slightly. Properly install all ductwork according to the installation instructions in this manual.

EXHAUST DUCTING GUIDE

Ducting

1. Make sure the dryer is installed properly so the air exhausts freely.
2. Use 4-inch rigid metal ducts. Tape all joints including the dryer connection. Never use lint-trapping screws.
3. To facilitate the exhaust, keep the ducts as straight as possible

Cleaning

Clean all old ducts before installing the dryer, and make sure the vent flap opens and closes freely. We recommend that you clean the exhaust system annually or on a regular basis.

- To prevent fire, do not use plastic, thin-foil, or non-metal flexible ducts of any kind.
- Do not use a poor exhaust system because it slows down the dryer’s performance.
- Do not use excessively long ducts that have multiple elbows.
- Do not use crushed or clogged venting or ducts.

DOOR REVERSAL

If you want to reverse the direction of the door, it is recommended to call a qualified service technician.

1. Unplug the power cord.
2. Remove the four hinge screws from the door
3. Remove the door by lifting it

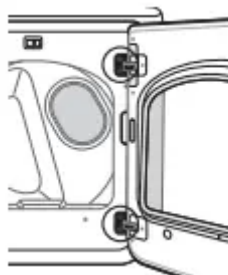



4. Remove the two screws from the holder lever, and then remove the cover holder.
5. Assemble the holder lever on the opposite side using the screws that were removed from the holder-lever-in Step 4.
6. Assemble the cover-holder on the opposite side.

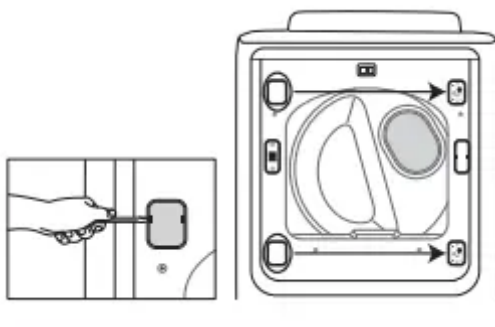

7. Remove the two cover hinges.

8. Assemble the two cover hinges on the opposite side.  Use an flat head screwdriver(-) to remove the cover holder's cover hinge.



9. Remove the 14 screws.  Two screws (L) are longer than the other screws.

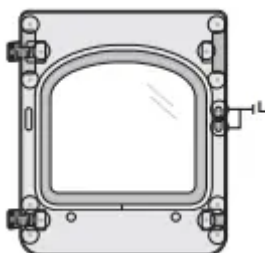

10. Remove the holder glass.

11. Exchange the positions of:: The cover-hinge and handle door: The holder-hinge and guide holder glass

12. Remove the Lever-Door, CoverLever (DV45H7000E(G)* Only), and then install it on the opposite side. : DV48(5)H7400E(G)*/ DV45H7200E(G)* Refer Figure. 1: DV45H7000E(G)*

Refer to Figure. 2  Refer to the illustrations on the right to aid you in the assembly process.

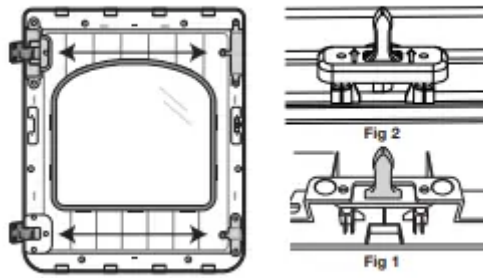

13. Remove the cover-hole (P).

14. Assemble the holder glass and then fasten the 14 screws that you removed in step 9.

15. Attach the cover-hole.

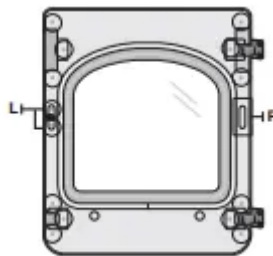

16. Install the door on the frame-front and then fasten the 4 screws that you removed in step

2.  Check the positions of the screws you installed in the hinged door.

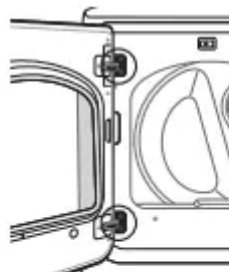

Operating instructions, tips



To reduce the risk of fire, electric shock, or injury to persons, read the IMPORTANT SAFETY INSTRUCTIONS before operating this appliance.

OVERVIEW OF THE CONTROL PANEL

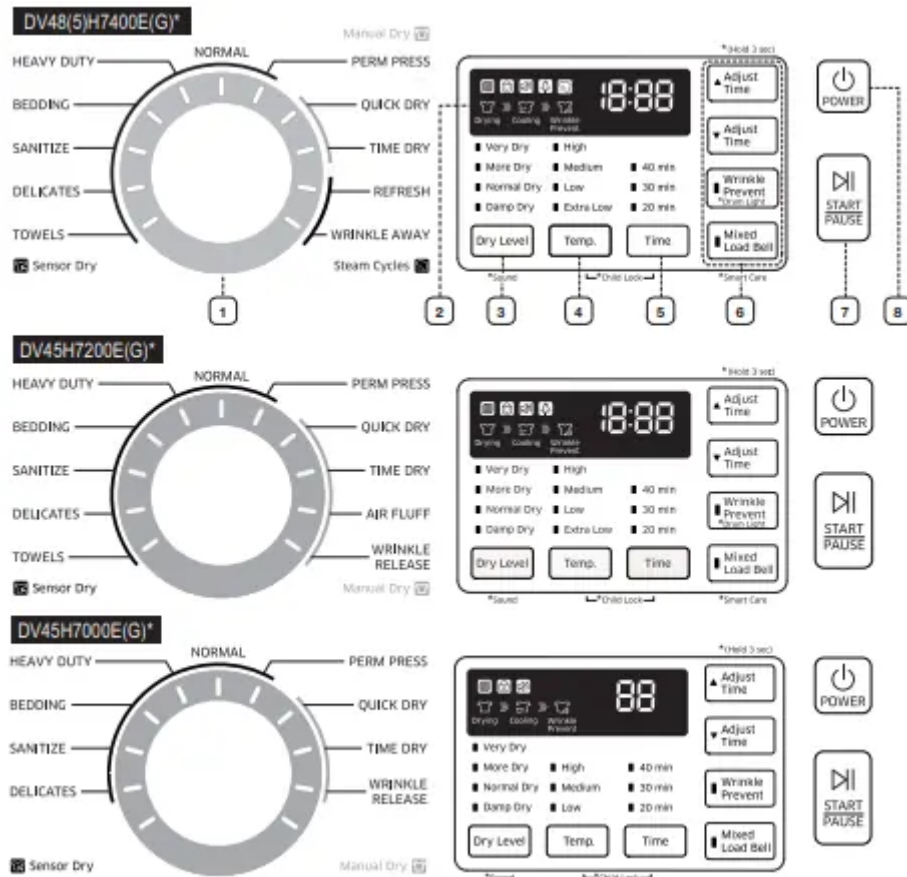

1. Cycle Selector

To select a cycle, rotate the Cycle Selector dial to the desired cycle. The indicator light by the cycle name will illuminate. The NORMAL, PERM PRESS, HEAVY DUTY, BEDDING, SANITIZE, DELICATES, AND TOWELS (DV48(5)H7400E(G)*, DV45H7200E(G)*) cycles are Sensor Dry cycles. Sensor Dry automatically senses the moisture in the load and shuts the dryer off when the load reaches the dryness level you have selected with the Dry Level Selection Button (see below).

NORMAL – Use this cycle to dry loads of cotton, underwear, and linen.

HEAVY DUTY – Use this cycle to dry heavy fabrics such as jeans, corduroys, or work clothes with high-temperature heat.

BEDDING – For bulky items such as blankets, sheets, and comforters.

SANITIZE – Sanitizes garments by infusing high-temperature heat deep into the fabric during the drying cycle. Use this cycle to keep your bedding and curtains clean through sanitization.

DELICATES – The Delicates cycle is designed to dry heat-sensitive items at a low drying temperature.

TOWELS (DV48(5)H7400E(G)*, DV45H7200E(G)*) – To dry bath towels and similar items.

PERM PRESS – Dry wrinkle-free cotton, synthetic fabrics, knits, and permanent press fabrics automatically.

QUICK DRY – Provides a 30-minute drying cycle.

TIME DRY – Time Dry allows you to select the desired cycle time in minutes. Turn the Cycle Selector dial to Time Dry, and then press the Adjust Time up arrow to set the drying time. Press the arrow repeatedly to scroll through the time settings.

REFRESH (DV48(5)H7400E(G)*) – Use to smooth out wrinkles and reduce odors in loads of one to four items. In this cycle, a small amount of water is sprayed into the dryer drum after several minutes of tumbling with heat. Confirm that the laundry load is dry.

AIR FLUFF (DV45H7200E(G)*) – The Air Fluff cycle tumbles the load at room temperature air.

WRINKLE AWAY (DV48(5)H7400E(G)*) – Removes wrinkles from clothes stored in closets, etc. It provides wrinkle release via optimized steam care. For best results, load 2-3 items at once. You can extend the drying time by a minimum of 20 minutes, depending on the item type or load. Confirm that the laundry load is dry.

WRINKLE RELEASE (DV45H7200E(G)* / DV45H7000E(G)*) – The Wrinkle Release cycle will release wrinkles from items that are clean, dry, and only slightly wrinkled, such as clothes from a crowded closet, suitcase, or items that have been in the dryer too long after the cycle has ended. Wrinkle Release can be used with any temperature selection

2. Digital Graphic Display

The display window shows the estimated time remaining in the cycle after you have pressed the Start/Pause button. The estimated time remaining may fluctuate as the cycle progresses.

The Drying light will illuminate and remain lit until the cycle is complete. When your dryer is in the cool-down phase, the Cooling light will illuminate. When your dryer is in the wrinkle-prevent phase, the Wrinkle Prevent light will illuminate. When the cycle is complete, “End” (DV48(5)H7400E(G)* / DV45H7200E(G)*) / “0” (DV45H7000E(G)* will appear in the display panel until you push the Start/Pause button or the Power button.

If your dryer is paused during a cycle, the indicator lights will blink until you press the Start/Pause button.

3. Dry Level Selection Button

To select the dry level in the Normal, Heavy Duty, or other Sensor Dry cycles, press the Dry Level button. An indicator light will illuminate next to the dryness level you selected.

Press the button repeatedly to scroll through the settings. Larger or bulkier loads may require the Very Dry or More Dry setting for complete dryness.

Damp Dry is designed to partially dry items. Use for items that lay flat or hang to dry.

4. Temp Selection Button

To select the temperature for the load, press the Temp button. An indicator light will illuminate next to the temperature you selected. Press the button repeatedly to scroll through the settings.

High – For sturdy cotton or those labeled Tumble Dry.

Medium – For permanent press, synthetics, lightweight cotton, or items labeled Tumble Dry Medium.

Low – For heat-sensitive items labeled Tumble Dry Low or Tumble Dry Warm.

Extra Low (DV48(5)H7400E(G)*, DV45H7200E(G)*) – Provides the lowest heated drying temperature possible.

5. Time Selection Button

When using Manual Dry cycles, you can adjust the drying time by pressing the time selection button.

During the Sensory Dry cycle, the time light indicator is off because exact drying times are determined by fluctuating humidity levels.

Therefore, the actual drying time may differ from the displayed time.

6. Select Cycle Option

Adjust Time – You can add or subtract time from the automatically set times in the Manual Dry cycles (Quick Dry, Time Dry, Air Fluff (DV45H7200E(G)*),

Wrinkle Release cycles or Wrinkle Away (DV48(5)H7400E(G)*) cycle. To add or subtract time from the cycle, press the Adjust Time arrow pad up or down until the desired time is displayed.

Wrinkle Prevent – Wrinkle Prevent provides approximately 180 minutes of intermittent tumbling in unheated air at the end of the cycle to reduce wrinkling. Press the Wrinkle Prevent button to activate this feature.

The indicator light above the pad will illuminate when you select Wrinkle Prevent. The load is dry and you can remove it at any time during the Wrinkle Prevent cycle.

Mixed Load Bell – The mixed load bell that notifies you when the average dry level in a load is damp dry (80 % dried). This lets you take garments that you don't want fully dried or that dry quickly out of the dryer early while letting others continue to dry. You can select this function in all Sensor Dry cycles except Sanitize. The dry level selections are limited to Normal Dry, Drier, and Very Dry.

Smart Care (DV48(5)H7400E(G)*, DV45H7200E(G)*) – Use this function to check if the Dryer is out of order using your smartphone when the Dryer malfunctions. This function is set if you press and hold the Mixed Load Bell key for 3 seconds.

7. Start/Pause selection button





Press to pause and restart programs.

8. Power button

Press once to turn your dryer on, Press again to turn it off. If you turn your dryer on and do not touch any buttons for 10 minutes, the power automatically turns off.

If you insert laundry into your dryer while it is extremely tangled immediately after your washer has finished a wash or spin cycle, it may degrade the drying efficiency or cause the door to open. We recommend that you disentangle your laundry appropriately before inserting it.

Each indicator on the graphic display means:

| | |
|---|-------------------|
|  | Filter Check |
|  | Child Lock On/Off |
|  | Sound On /Off |
|  | Drum Light On/Off |
|  | Steam |

CHILD LOCK

Prevents children from playing with your dryer.

Setting/Releasing

If you want to set or release the Child Lock, press the Temp. and Time buttons simultaneously for 3 seconds.

Child Lock Details

- You can turn Child Lock on while your dryer is running.
- Once you turn Child Lock on, no button, except for the Power button, will respond until you turn off the Child Lock function.
- The Child Lock indicator will be lit.

If you have not turned off Child Lock, and then turned the dryer off and on, the Child Lock function will still be on. To turn off Child Lock, follow the instructions above.

When other buttons, except for the Power button, do not respond, check the Child Lock indicator. If Child Lock is on, follow the instructions above to turn Child Lock off.

DRUM LIGHT (DV48(5)H7400E(G)*, DV45H7200E(G)* ONLY)

Lights the dryer drum while the dryer is running.

Turning On and Off

Press and hold the Wrinkle Prevent button for 3 seconds or more.

You can turn the Drum Light on and off while your dryer is running and when it is stopped. If you do not turn the Drum Light off 5 minutes after turning it on, the Drum Light automatically turns off.

SOUND

The Sound Off function can be selected during all courses.

Activating

If you want to activate the Sound Off function, press the Dry Level button at the same time for 3 seconds. The “” will be lit when this feature is activated.

Deactivating

If you want to deactivate the Sound Off function, press the Dry Level button at the same time for 3 seconds again.

When this function is selected, the sound is turned off for all courses.

Even if the power is turned on and off repeatedly, the setting is retained.

SMART CARE (DV48(5)H7400E(G)*, DV45H7200E(G)* ONLY)

This function enables you to check the status of the dryer using a smartphone.

1. To enable the Smart Care function, press the power button to turn the dryer on and then press and hold the Mixed Load Bell button for 3 seconds. If you press a button other than the Mixed Load Bell button after turning the dryer on, you will not be able to activate the Smart Care function. • The error code history is deleted after using the function.
2. If the Smart Care function is activated, the Smart Care indicator is lit on the display.
3. Run the Smart Care app on your smartphone. • GalaxyS, GalaxyS2, GalaxyS3, GalaxyS4, GalaxyS2(HD), Galaxy Note, Galaxy Note2, Galaxy Note3 (Other devices may not be normal operation). Supported operating system: Android 2.2 or higher. • iPhone 3 G S, iPhone 4/4S, iPhone 5/5S. Supported operating system: OS 4.3 or higher.
4. Focus the smartphone's camera on the display panel of the Dryer.
5. If the smartphone's camera is focused on the display panel of the Dryer, the panel and error message is automatically recognized and the error type and countermeasures are displayed on the smartphone.
6. If the smartphone fails to recognize the error code more than twice, please enter the error code displayed on the display panel of the dryer manually into the Smart Care app.

Downloading the Smart Care app

- Download the Samsung Laundry App to your mobile phone from the Android market or Apple App store. (Search word: Samsung Smart Washer/Dryer)

Precautions when using Smart Care

- If light from a light bulb, fluorescent bulb, or lamp is reflected on the display panel of the dryer, the smartphone may not be able to recognize the panel or error message easily.

- If you hold the smartphone at too large an angle relative to the front of the display panel, it may not be able to recognize the error code. For best results, hold the smartphone so that the front of the panel and the smartphone are parallel or nearly parallel.

CLEAN THE LINT FILTER

- After each load.
- To shorten drying time.
- To operate more energy efficiently.

Do not operate your dryer without the lint filter in place.

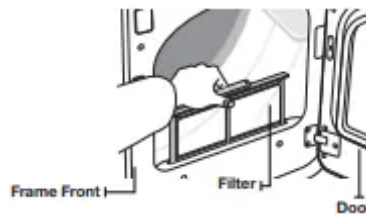

LOAD THE DRYER PROPERLY

- Place only one washload in your dryer at a time.
- In mixed loads, heavy and lightweight fabrics will dry differently. This may result in lightweight fabrics being dry while heavy fabrics remain damp at the end of a drying cycle.
- Add one or more additional similar items to your dryer when you are drying only one or two items. This improves the tumbling action and drying efficiency.
- Overloading restricts tumbling action, resulting in uneven drying as well as excessive wrinkling of some fabrics.

GETTING STARTED

1. Load your dryer loosely – DO NOT overload.
2. Close the door.
3. Select the appropriate cycle and options for the load (see pages 21, 22, 23).
4. Press the Start/Pause button.
5. The dryer indicator light will illuminate.
6. The estimated cycle time will appear in the display.

The time may fluctuate as humidity levels fluctuate in the dryer.

- When the cycle is complete, “End” (DV48(5)H7400E(G)* / DV45H7200E(G)*) / “0” (DV45H7000E(G)*) will appear in the display.
- Pressing Power cancels the cycle and stops your dryer.

- The Drying, Cooling, and Wrinkle Prevent indicator lights will illuminate during those portions of the cycle.

Do not place anything on top of your dryer while it is running.

Care and cleaning

CONTROL PANEL

Clean with a soft, damp cloth.

Do not use abrasive substances. Do not spray cleaners directly on the panel.

The control panel finish may be damaged by some laundry pre-treatment soil and stain remover products.

Apply such products away from your dryer and wipe up any spills or overspray immediately.

TUMBLER

Remove any stains from the tumbler caused by crayons, ink, fabric dye (from new items such as towels or jeans), and so on with an all-purpose cleaner.

Tumble old towels or rags to remove any remaining stains or cleaning substance.

Once these steps are followed, stains may still be visible, but should not transfer to subsequent loads.

POWDER COATED TUMBLER

To clean the powder-coated tumbler, use a damp cloth with a mild, non-abrasive cleaner suitable for easily marred surfaces.

Remove cleaner residue and dry with a clean cloth.

DRYER EXTERIOR

Clean with a soft, damp cloth. Do not use abrasive substances.

Protect the surface from sharp objects.

Do not place any heavy or sharp objects or a detergent box on the dryer. They can scratch or damage the top cover of the dryer. Keep these items in the separately purchased pedestal or in a separate storage box. The entire dryer has a high-gloss finish. Avoid scratching or damaging the surface when using the dryer. DRYER

EXHAUST SYSTEM

Inspect and clean the dryer exhaust system yearly to maintain optimum performance.

The outside exhaust hood should be cleaned more frequently to ensure proper operation.

Special laundry tips

SPECIAL LAUNDRY TIPS

Please follow the care label or manufacturer's instructions for drying special items. If care label instructions are not available, use the following information as a guide.

Bedspreads & Comforters

- Follow the care label instructions or dry using the Bedding cycle.
- Make sure the item is thoroughly dry before using or storing it.
- May require repositioning to ensure even drying.

Blankets

- Use the Normal cycle and dry only one blanket at a time for the best tumbling action.
- Make sure that most thoroughly dry before using or storing.

Curtains & Draperies

- Use the Perm Press cycle and medium temperature to help minimize wrinkling.
- Dry these in small loads for best results and remove them as soon as possible.

Cloth Diapers

- Use the Normal cycle and the High-temperature settings for soft, fluffy diapers.

Down-filled Items (jackets, sleeping bags, comforters, etc.)

- Use the Normal cycle and medium temperature setting.
- Adding a couple of dry towels shortens drying time and absorbs moisture.

Foam Rubber (rug backs, stuffed toys, shoulder pads, etc.)

- DO NOT dry in a heat setting. Use the Air Fluff cycle (no heat DV45H7200E(G)* only).
- WARNING – Drying a rubber item with heat may damage it or create a fire hazard.

Pillows

- Use the Normal cycle.
- Add a couple of dry towels and a pair of clean sneakers to help the tumbling action and to fluff the items.
- DO NOT dry kapok or foam pillows in the dryer. You can dry these items in the dryer only if you use the Air Fluff cycle.

Plastics (shower curtains, outdoor furniture covers, etc.)

- Use the Air Fluff cycle or the Time Dry cycle and the Low or Extra Low-temperature settings depending on the care label instructions.

THINGS TO AVOID PUTTING IN THE DRYER :

- Fiberglass items (curtains, draperies, etc.).
- Woolens, unless recommended on the label.
- Items spotted or soaked with vegetable or cooking oils.

Troubleshooting

CHECK THESE POINTS IF YOUR DRYER...

Doesn't run.

- Make sure the door is latched shut.
- Be sure the power cord is plugged into a live electrical outlet.
- Check your home's circuit breakers or fuses.
- Press the Start/Pause button again if the door is opened during the cycle.

Doesn't heat.

- Check your home's circuit breakers or fuses.
- Select a heat setting other than Air Fluff.
- On a gas dryer, check that the gas supply is on.
- Clean the lint filter and exhaust duct.
- The dryer may have moved into the cool-down phase of the cycle

Doesn't dry.

- Check all of the above, plus...
- Be sure the exhaust hood outside the home can open and close freely.
- Check the exhaust system for lint buildup. Ducting should be inspected and cleaned annually. • Use a 4" rigid metal exhaust duct.
- Do not overload. 1 wash load = 1 dryer load.
- Sort heavy items from lightweight items.
- Large, bulky items like blankets or comforters may require repositioning to ensure even drying.
- Check that the washer is draining properly to extract adequate water from the load.
- The load may be too small to tumble properly. Add a few towels

Is noisy.

- Check the load for objects such as coins, loose buttons, nails, etc. Remove promptly.
- It is normal to hear the dryer gas valve or heating element cycle on and off during the drying cycle.
- Be sure the dryer is leveled properly as outlined in the installation instruction.
- It is normal for the dryer to hum due to the high velocity of air moving through the dryer drum and exhaust system.

Dries unevenly.

- Seams, pockets, and other similarly heavy areas may not be completely dry when the rest of the load has reached the selected dryness level. This is normal. Select the Very Dry setting if desired.
- If one heavy item is dried with a lightweight load, such as one towel with sheets, it is possible that the heavy item will not be completely dry when the rest of the load has reached the selected dryness level. Sort heavy items from lightweight items for best drying results.

Has an odor.

- Household odors from paint, varnish, strong cleaners, etc. may enter the dryer with the surrounding room air. This is normal as the dryer draws the air from the room, heats it, pulls it through the tumbler, and exhausts it outside.
- When these odors linger in the air, ventilate the room completely before using the dryer.

Shuts off before the load is dry.

- The dryer load is too small. Add more items or a few towels and restart the cycle.
- The dryer load is too large. Remove some items and restart the dryer.

Lint on clothes.

- Make sure the lint filter is cleaned before every load. With some loads that produce high amounts of lint, it may be necessary to clean the filter during the cycle.
- Some fabrics are lint producers (for example, a fuzzy white cotton towel) and they should be dried separately from clothes that are lint trappers (for example, a pair of black linen pants).
- Divide larger loads into smaller loads for drying.
- Check pockets thoroughly before washing and drying clothes.

Garments still wrinkled after Wrinkle Release.

- Small loads of 1 to 4 items work best.
- Load fewer garments. Load similar-type garments.

Odors remain in clothing after Air Fluff.

- Fabrics containing strong odors should be washed in a normal cycle.

INFORMATION CODES

Information codes may be displayed to help you understand what is occurring with your Dryer better.

Code to

Temperature sensor problem.

- Restart the cycle.
- If the code reappears, call for service.

Code HE

Invalid heating Temp in running the dryer).

- Call for service.

Code de

Running the dryer with the door open.

- Close the door and then restart.
- If the problem continues, call for service.

Code FE

Invalid power source Frequency.

- Try restarting the cycle.
- If the problem continues, call for service

Code 9E1

Electronic Control Problem (Over Voltage Error).

- Call for service.

Code AE

Electronic Control Problem (Over Voltage Error).

- Call for service.

Code E3

Invalid state of Eeprom Communication.

- Call for service.

Code dF

Invalid door.

- Call for service.

bE (DV45H7000E(G)*) bE2

The unit detects a button is being pressed for over 30secs or the button is stuck.

- Make sure a button is NOT being pressed continuously. Try restarting the cycle. If the problem continues, call for service.

For any codes not listed above, call 1–800–726–7864 (1–800–SAMSUNG).

Warning

This content is compiled from multiple sources and is provided for reference purposes only. It may not be complete or fully applicable to all situations. If you are unable to resolve your issue, please contact the product manufacturer or an authorized service provider for official support.

Document generated by [ManualsFile](#)