

INSTALLATION

Parts

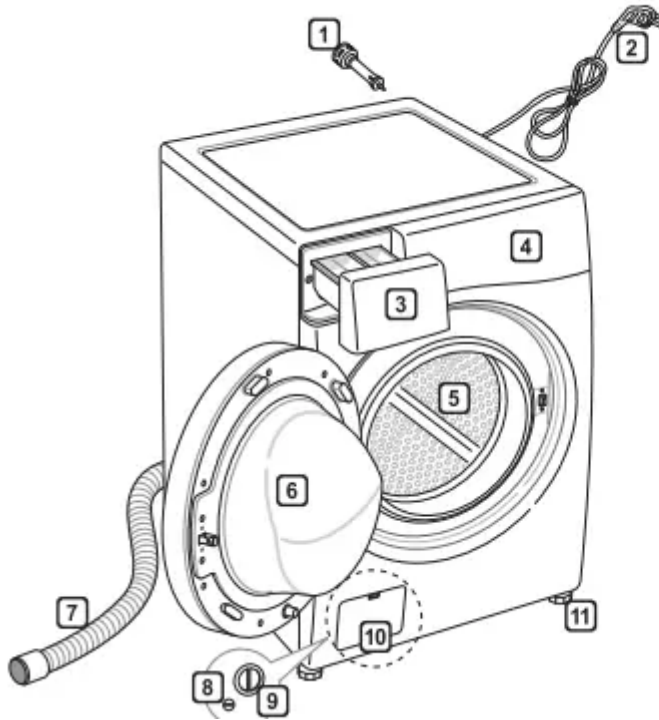

- 1 Transit bolts
- 2 Power plug
- 3 Drawer
- 4 Control panel
- 5 Drum
- 6 Door
- 7 Drain hose
- 8 Drain plug
- 9 Drain pump filter
- 10 Cover cap (Location may vary depending on products)
- 11 Adjustable feet

Accessories



Cold supply hose (1 EA)
(Option: Hot (1 EA))



Spanner



Caps for covering transit bolt holes
(Optional)



Anti-slip sheets (2 EA)
(Optional)



Elbow bracket for securing drain hose
(Optional)



Tie strap (Optional)



Specifications

Model	F4J6AM2W/S W5J6AM0WW F4J*TM(P)(0~9)W/S FWJ685WN
Wash Capacity	8 kg (Wash) / 5 kg (Dry)
Power Supply	220 - 240 V~, 50 Hz
Size	600 mm (W) x 560 mm (D) x 850 mm (H)
Product Weight	68 kg
Permissible Water pressure	0.1 - 1.0 MPa (1.0 - 10.0 kgf / cm ²)

- Appearance and specifications may change without notice to improve the quality of the product.
- No further backflow protection required for connection to the water supply.
- Country of origin: Made In China

Installation Place Requirements

Location

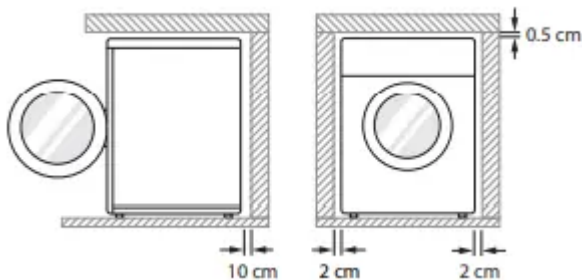

Level floor : Allowable slope under the entire appliance is 1°.

Power outlet : Must be within 1 meter of either side of the location of the appliance.

- Do not overload the outlet with more than one appliance.

Additional Clearance : For the wall, 10 cm: rear/2 cm: right & left side

- Do not place or store laundry products on top of the appliance at any time. These products may damage the finish or controls.

WARNING

- The plug must be plugged into an appropriate outlet that is properly installed and grounded in accordance with all local codes and ordinances.

Positioning

- Install the appliance on a flat hard floor.

- Make sure that air circulation around the appliance is not impeded by carpets, rugs, etc.
- Never try to correct any unevenness in the floor with pieces of wood, cardboard or similar materials under the appliance.
- If it is impossible to avoid positioning the appliance next to a gas cooker or coal burning stove, an insulation (85x60 cm) covered with aluminum foil on the side facing the cooker or stove must be inserted between the two appliances.
- Do not install the appliance in rooms where freezing temperatures may occur. Frozen hoses may burst under pressure. The reliability of the electronic control unit may be impaired at temperatures below freezing point.
- Ensure that when the appliance is installed, it is easily accessible for an engineer in the event of a breakdown.
- With the appliance installed, adjust all four feet using the transit bolt spanner provided to ensure the appliance is stable, and a clearance of approximately 5 mm is left between the top of the appliance and the underside of any worktop
- If the appliance is delivered in winter and temperatures are below freezing, place the appliance at room temperature for a few hours before putting it into operation.

WARNING

- This equipment is not designed for maritime use or for use in mobile installations such as caravans, aircraft etc.

Electrical Connection

- Do not use an extension cord or double adapter.
- Always unplug the appliance and turn off the water supply after use.
- Connect the appliance to an earthed socket in accordance with current wiring regulations.
- The appliance must be positioned so that the plug is easily accessible.
- Repairs to the appliance must only be carried out by qualified personnel. Repairs carried out by inexperienced persons may cause injury or serious malfunctioning. Contact your local service centre.

Unpacking and Removing Transit Bolts

1 Lift the appliance off the foam base.

- After removing the carton and shipping material, lift the appliance off the foam base. Make sure the tub support comes off with the base and is not stuck to the bottom of the appliance.
- If you must lay the appliance down to remove the carton base, always protect the side of the appliance and lay it carefully on its side. Do not lay the appliance on its front or back.

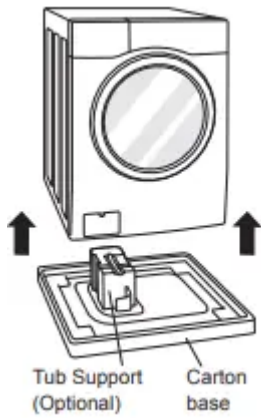

2 Remove the bolt assemblies.

- Starting with the bottom two transit bolts, use the spanner (included) to fully loosen all transit bolts by turning them counterclockwise. Remove the bolt assemblies by wiggling them slightly while pulling them out.

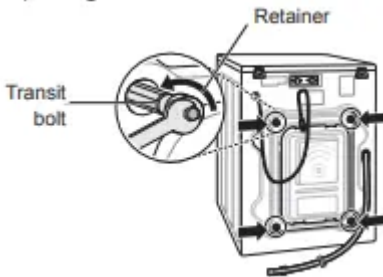

3 Install the hole caps.

- Locate the hole caps included in the accessory pack or attached on the back.

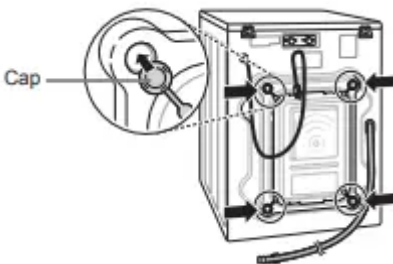

NOTE

- Save the bolt assemblies for future use. To prevent damage to internal components, Do not transport the washing machine without reinstalling the transit bolts.
- Failure to remove transit bolts and retainers may cause severe vibration and noise, which can lead to permanent damage to the washing machine. The cord is secured to the back of the washing machine with a transit bolt to help prevent operation with transit bolts in place.

Leveling the Appliance

If the floor is uneven, turn the adjustable feet as required (Do not insert pieces of wood etc. under the feet). Make sure that all four feet are stable and resting on the floor and then check that the appliance is perfectly level (Use a spirit level).

- Once the appliance is level, tighten the lock nuts up towards the base of the appliance. All lock nuts must be tightened.

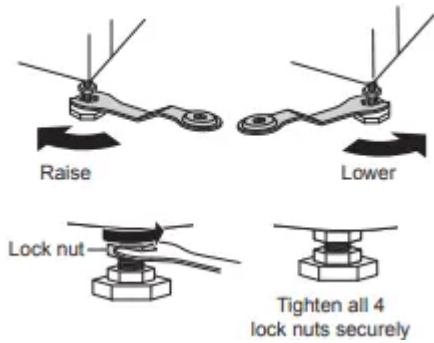

Diagonal Check

- When pushing down the edges of the top plate diagonally, the appliance should not move up and down at all (check both directions). If the appliance rocks when pushing the machine top plate diagonally, adjust the feet again.

NOTE

- Timber or suspended type flooring may contribute to excessive vibration and unbalance.
- If the washing machine is installed on a raised platform, it must be securely fastened in order to eliminate the risk of falling off.

Connecting the Water Supply Hose

- Water supply pressure must be between 0.1 MPa and 1.0 MPa (1.0–10.0 kgf/cm²).
- Do not overtighten the water supply hose.
- If the water supply pressure is more than 1.0 MPa, a decompression device should be installed.
- Periodically check the condition of the hose and replace the hose if necessary.

Checking the Rubber Seal on the Water Supply Hose

Two rubber seals are supplied with the water inlet hoses. They are used for preventing water leaks. Make sure the connection to taps is sufficiently tight.

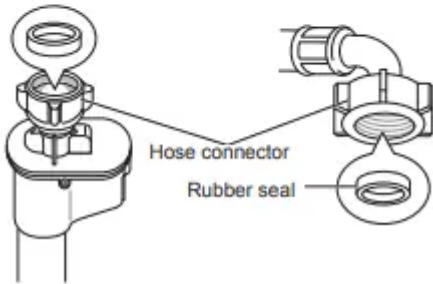
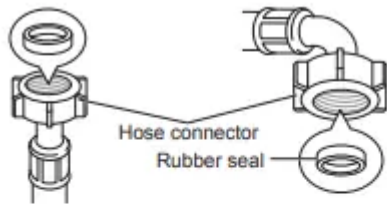

Connecting Hose to Water Tap

Connecting Screw-Type Hose to Tap with Thread

Screw the hose connector onto the water supply tap.

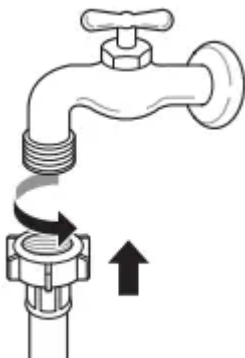

Connecting Screw-Type Hose to Tap Without Thread

1 Loose the four fixing screws.

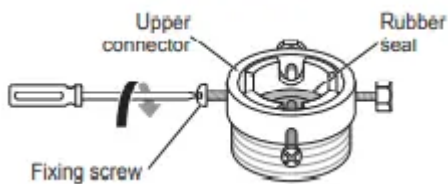

2 Remove the guide plate if the tap is too large to fit the adapter.

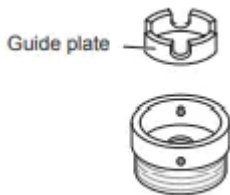

3 Push the adapter onto the end of the tap so that the rubber seal forms a watertight connection. Tighten the four fixing screws.



4 Push the supply hose vertically upwards so that the rubber seal within the hose can adhere completely to the tap and then tighten it by screwing it to the right.

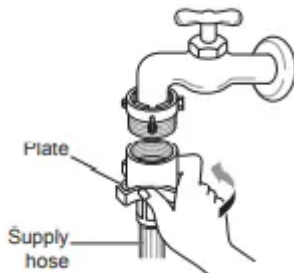

Connecting One Touch Type Hose to Tap Without Thread

1 Unscrew the adapter ring plate and loose the four fixing screws.

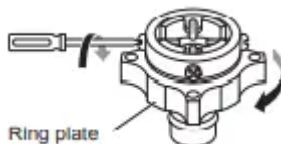

2 Remove the guide plate if the tap is too large to fit the adapter.

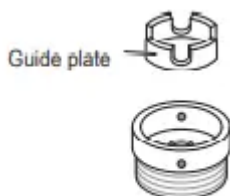

3 Push the adapter onto the end of the tap so that the rubber seal forms a watertight connection. Tighten the four fixing screws and the adapter ring plate.

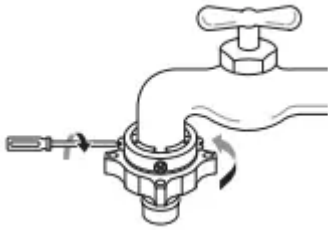

4 Pull the connector latch plate down, push the supply hose onto the adapter, and release the connector latch plate. Make sure the adapter locks into place.

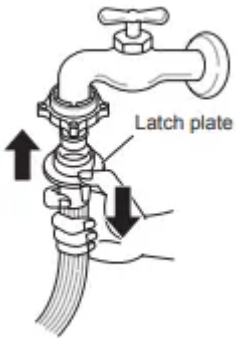

NOTE

- Before connecting the supply hose to the water tap, turn on the water tap to flush out foreign substances (dirt, sand, sawdust, and etc.) in the water lines. Let the water drain into a bucket, and check the water temperature.

Connecting Hose to Appliance

Attach the hot water line to the hot water supply on the back of the washer. Attach the cold water line to the cold water supply on the back of the washer.

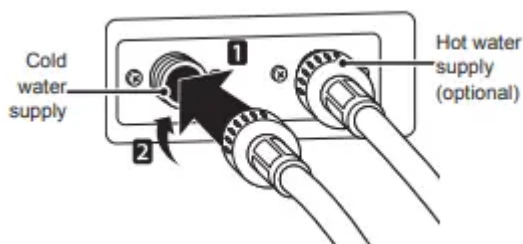

NOTE

- After completing connection, if water leaks from the hose, repeat the same steps. Use the most conventional type of tap for the water supply. In case the tap is square or too big, remove the guide plate before inserting the tap into the adaptor.

Using the Horizontal Tap

Horizontal tap



Extension tap



Square tap



Installing the Drain Hose

- The drain hose should not be placed higher than 100 cm above the floor. Water in the appliance may not drain or may drain slowly.
- Securing the drain hose correctly will protect the floor from damage due to water leakage.
- If the drain hose is too long, do not force it back into the appliance. This will cause abnormal noise.

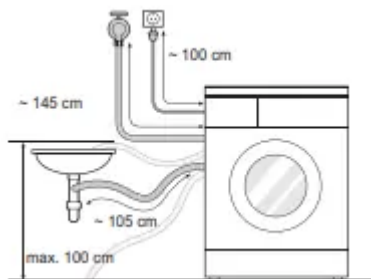

- When installing the drain hose to a sink, secure it tightly with string.
- Securing the drain hose correctly will protect the floor from damage due to water leakage.

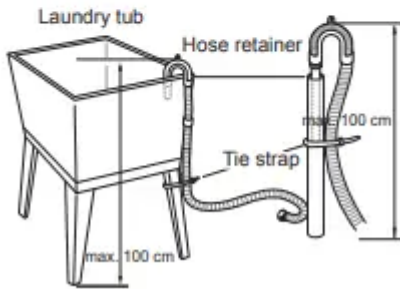
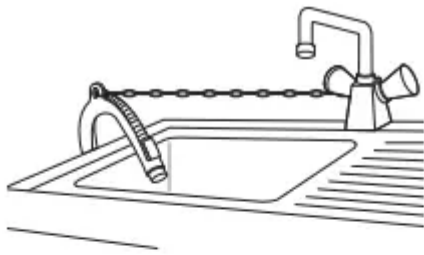

OPERATION

Using the Washing Machine

Before the first wash, select a washing programme, allow the washing machine to wash without clothing. This will remove residue and water from the drum that may have been left during manufacturing.

1 Sort laundry and load the washer.

- Sort laundry by fabric type, soil level, color and load size as needed. Open the door and load items into the washing machine.

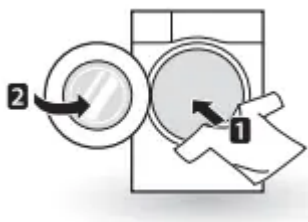

2 Add cleaning products.

- Add the proper amount of detergent to the detergent dispenser drawer. If desired, add bleach or fabric softener to the appropriate areas of the dispenser.



3 Turn on the washing machine.

- Press the Power button to turn on the washing machine.



4 Choose the desired washing cycle.

- Press the cycle button repeatedly or turn the cycle selector knob until the desired cycle is selected.



5 Begin cycle.

- Press the Start/Pause button to begin the cycle. The washing machine will agitate briefly without water to measure the weight of the load. If the Start/Pause button is not pressed within 5 minutes, the washing machine will shut off and all settings will be lost.



6 End of cycle.

- When the cycle is finished, a melody will sound. Immediately remove your clothing from the washing machine to reduce wrinkling. Check around the door seal when removing the load for small items that may be caught in the seal.

Sorting Laundry

1 Look for a care label on your clothes.

- This will tell you about the fabric content of your garment and how it should be washed.
- Symbols on the care labels

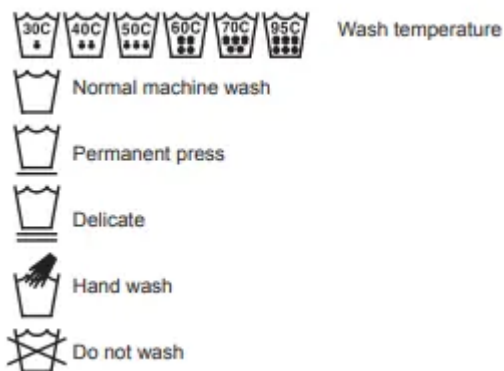

2 Sorting laundry.

- To get the best results, sort clothes into loads that can be washed with the same wash cycle.
- Different fabrics need to be washed at varying temperatures and spin speeds.
- Always sort dark colours from pale colours and whites. Wash separately as dye and lint transfer can occur causing discolouration of white and pale garments. If possible, do not wash heavily soiled items with lightly soiled ones.
 - Soil (Heavy, Normal, Light) : Separate clothes according to amount of soil.
 - Colour (White, Lights, Darks): Separate white fabrics from coloured fabrics.
 - Lint (Lint producers, Collectors): Wash lint producers and lint collectors separately.

3 Caring before loading.

- Combine large and small items in a load. Load large items first.
- Large items should not be more than half the total wash load. Do not wash single items. This may cause an unbalanced load. Add one or two similar items.
- Check all pockets to make sure that they are empty. Items such as nails, hair clips, matches, pens, coins and keys can damage both your washing machine and your clothes.
- Close zippers, hooks and strings to make sure that these items don't snag on other clothes.



- Pre-treat dirt and stains by brushing a small amount of detergent dissolved water onto stains to help lift dirt.
- Check the folds of the flexible gasket (gray) and remove any small articles.

CAUTION

- Check inside the drum and remove any items from a previous wash.



- Remove any clothing or items from the flexible gasket to prevent clothing and gasket damage.



Adding Cleaning Products

Detergent Dosage

- Detergent should be used according to the instruction of the detergent manufacturer and selected according to type, colour, soiling of the fabric and washing temperature.
- If too much detergent is used, too many suds can occur and this will result in poor washing results or cause heavy load to the motor.
- If you wish to use liquid detergent follow the guidelines provided by the detergent manufacturer.
- You can pour liquid detergent directly into the main detergent drawer if you are starting the cycle immediately.
- Do not use liquid detergent if you are using Time delay, or if you have selected Pre Wash, as the liquid may harden.
- If too many suds occur, reduce the detergent amount.
- Detergent usage may need to be adjusted for water temperature, water hardness, size and soil level of the load. For best results, avoid oversudsing.
- Refer to the label of the clothes, before choosing the detergent and water temperature.
- When using the washing machine, use designated detergent for each type of clothing only:
 - General powdered detergents for all types of fabric
 - Powdered detergents for delicate fabric
 - Liquid detergents for all types of fabric or designated detergents only for wool
- For better washing performance and whitening, use detergent with the general powdered bleach.



- Detergent is flushed from the dispenser at the beginning of the cycle.

NOTE

- Do not let the detergent harden. Doing so may lead to blockages, poor rinse performance or odour.
- Full load : According to manufacturer's recommendation.
- Part load : 3/4 of the normal amount
- Minimum load : 1/2 of full load

Adding Detergent and Fabric Softener

Adding Detergent

- Main wash only → 
- Pre wash+Main wash →  • 

NOTE

- Too much detergent, bleach or softener may cause an overflow.
- Be sure to use the appropriate amount of detergent.

Adding Fabric Softener

- Do not exceed the maximum fill line. Overfilling can cause early dispensing of the fabric softener, which may stain clothes. Close the dispenser drawer slowly.

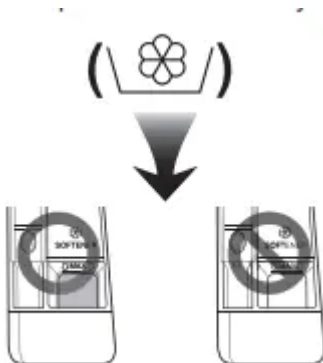

- Do not leave the fabric softener in the detergent drawer for more than 2 days (Fabric softener may harden).
- Softener will automatically be added during the last rinse cycle.
- Do not open the drawer when water is being supplied.
- Solvents (benzene, etc.) must not be used.

NOTE

- Do not pour fabric softener directly on the clothes.

Adding Water Softener

- A water softener, such as anti-limescale can be used to cut down on the use of detergent in areas with high water hardness level. Dispense according to the amount specified on the packaging. First add detergent and then the water softener.
- Use the quantity of detergent required for soft water.



Using Tablet

1 Open the door and put tablets into the drum.

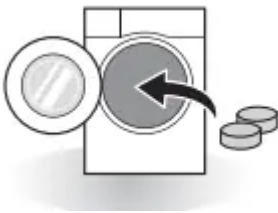

2 Load the laundry into the drum and close the door.

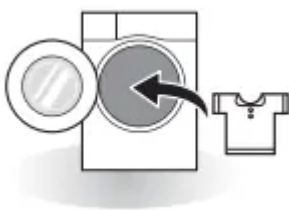

Control Panel

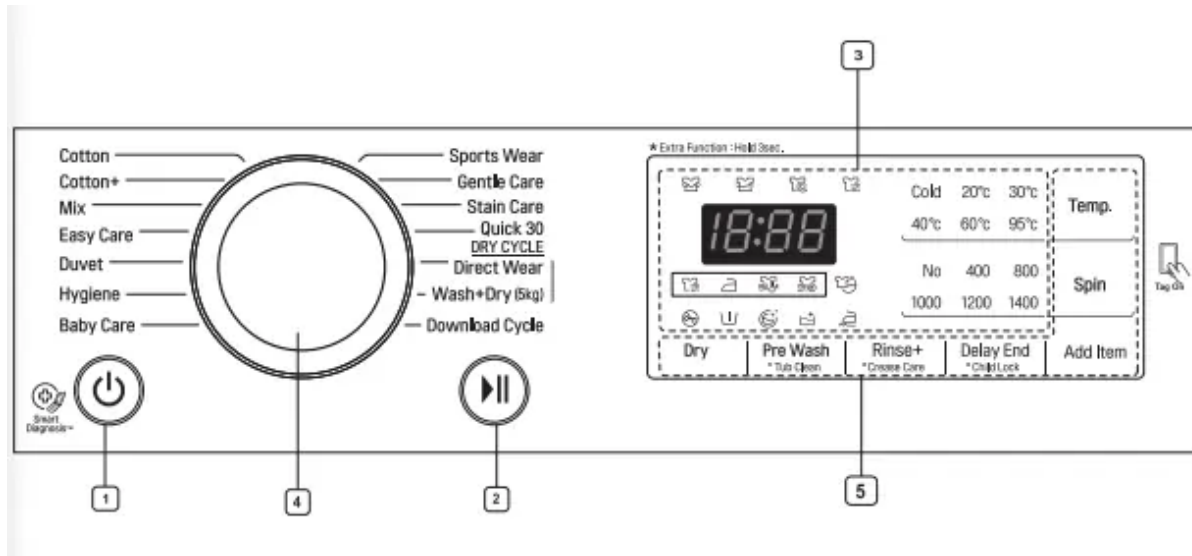

1 Power Button

- Press the Power button to turn the washing machine on.

2 Start/Pause Button

- This Start/Pause button is used to start the wash cycle or pause the wash cycle.
- If a temporary stop of the wash cycle is needed, press the Start/Pause button.

3 Display

- The display shows the settings, estimated time remaining, options, and status messages. When the product is turned on, the default settings in the display will illuminate.
- The display shows estimate time remaining. While the size of the load is being calculated automatically, blinking  or 'Detecting' appears.
- The RPM may differ depending on the models.

4 Programme Knob

- Programmes are available according to laundry type.
- Lamp will light up to indicate the selected programme.

5 Options

- This allows you to select an additional programme and will light when selected.
- Use these buttons to select the desired programme options for the selected cycle.

Programme Table

Washing Programme

Programme	Description	Fabric Type	Proper Temp.	Maximum Load
Cotton	Provides better performance by combining various drum motions.	Coloured fast garments (shirts, nightdresses, pajamas, etc.) and normally soiled cotton load (underwear).	40 °C (Cold to 95 °C)	Rating
Cotton+	Provides optimised washing performance for large amount of laundry with less energy consumption.		60 °C (Cold to 60 °C)	
Easy Care	Suitable for casual shirts that do not need ironing after washing.	Polyamide, acrylic, polyester.	40 °C (Cold to 60 °C)	3 kg
Mix	Enables various fabrics to be washed simultaneously.	Various kind of fabrics except special garments (silk/delicate, sports wear, dark clothes, wool, duvet/curtains).	40 °C (Cold to 40 °C)	
Hygiene	Washes laundry in a hot programme.	Cotton, underwear, pillow covers, bed sheets, baby wear.	60 °C	
Duvet	For large items such as bed covers, pillows, sofa covers, etc.	Cotton bedding except special garments (delicates, wool, silk, etc.) with filling: duvets, pillows, blankets, sofa covers with light filling	40 °C (Cold to 40 °C)	1 single size
Sports Wear	Suitable for sports wear such as jogging clothes and running wear.	Coolmax, gore-tex, fleece and sympatex		2 kg
Baby Care	Removes solid and protein stains, provides better rinse performance.	Lightly soiled baby wear.	60 °C	4 kg
Wash+Dry	Provides a nonstop process of washing and drying in the same programme.	A small amount of laundry which can be dried.	40 °C (Cold to 95 °C)	5 kg





Programme	Description	Fabric Type	Proper Temp.	Maximum Load
Direct Wear	Provides washing to drying within 80 mins at once for light soiled 1-3 shirts.	Cotton mixed, polyester mixed dress shirts, blouses.	20 °C	3 items
Quick 30	Provides fast washing time for small loads and lightly soiled clothes.	Lightly soiled colour laundry.	20 °C (Cold to 40 °C)	2 kg
Gentle Care	For hand and machine washable delicate clothes such as washable wool, lingerie, dresses etc. (Use detergent for machine washable woolens).	Wool, hand washable clothes, delicate, easily damaged laundry.	20 °C (Cold to 30 °C)	1.5 kg
Stain Care	Wash off several kinds of stain such as wine, juice, dirt, etc. (Water temperature is increased step by step for washing various stains).	Cotton blended fabrics, no delicate clothes.	40 °C (30 °C to 60 °C)	3 kg
Download Cycle	For downloadable programmes. If you did not download any programmes, the default is Rinse+Spin.			

- Water Temperature: Select the appropriate water temperature for chosen wash programme. Always follow garment manufacturer's care label or instructions when washing.

NOTE

- Neutral detergent is recommended.

Drying Programme

Programme	Description	Fabric Type	Maximum Load
Normal ()	For cottons. Select this programme to reduce the drying time and energy usage during dry cycle.	Cotton or linen fabrics such as cotton towels, T-shirts, and linen laundries.	Rating
Normal Eco ()	For energy dry programme.		
Low Temp. ()	For less clothes damage, it dries in low temperature.	Easy care textiles, synthetic fabrics suitable for Easy Care, Mix programme washable clothes.	3 kg
Iron ()	For easy iron, finish drying in damp condition.	Cotton or linen fabrics, ready to iron at the end of programme.	Rating
Time 30 min.	You can change the drying time according to the maximum load.	Cotton, towel	0.5 kg
Time 60 min.			1.5 kg
Time 90 min.			2.5 kg
Time 120 min.			3 kg
Time 150 min.			4 kg

- Set programme at 'Wash : Cotton +, 60 °C, 1400 RPM' and 'Dry : Normal Eco Dry ()' for test in accordance with EN50229.

NOTE

- Select maximum selectable spin speed of washing programme to ensure drying results.
- Where the amount of laundry to be washed and dried in one programme does not exceed the maximum weight permitted for the drying programme, washing and drying in one continuous sequence is recommended.
- Actual maximum spin speed may vary depending on the model, programme, and load conditions.

Extra Options

Programme	Rinse+	Delay End	Crease Care	Pre Wash	Dry
Cotton	•	•	•	•	•
Cotton+	•	•	•	•	•
Easy Care	•	•	•	•	•
Mix	•	•	•	•	•
Hygiene	•	•	•		•
Baby Care	•	•	•		•
Wash+Dry	•	•		•	•*
Duvet	•	•	•		
Sports Wear	•	•	•		
Direct Wear		•			•*
Quick 30	•	•	•	•	•
Gentle Care	•	•	•		
Stain Care	•	•	•	•*	•

* : This option is automatically included in the cycle and can not be deleted.

Operating Data

Programme	Max RPM
Cotton	1400
Cotton+	1400
Easy Care	1000
Mix	1400
Hygiene	1400
Baby Care	1000
Wash+Dry	1400
Duvet	1000
Sports Wear	800
Direct Wear	1000
Quick 30	1400
Gentle Care	800
Stain Care	1400

Programme	Time in Minutes	Remaining moisture content	Water in Litre	Energy in kWh
Cotton (40 °C)	96	44 %	48	0.4
Cotton+ (60 °C)	246	45 %	45	0.52

NOTE

- Information of main washing programmes at half load.

Option Programme

Delay End

You can set a time delay so that the washing machine will start automatically and finish after a specified time interval.

- 1 Press the Power button.
- 2 Select a washing programme.
- 3 Press the Delay End button to set time required.
- 4 Press the Start/Pause button.

NOTE

- The delay time is the time to the end of the programme, not the start. The actual running time may vary due to water temperature, wash load and other factors.
- To cancel the function, the power button should be pressed.
- Avoid using liquid detergent for this option.

Pre Wash ()

If the laundry is heavily soiled, the Pre Wash programme is recommended.

- 1 Press the Power button.
- 2 Select a washing programme. 3 Press the Pre Wash button.
- 4 Press the Start/Pause button.

Crease Care ()

If you want to prevent creasing, the Crease Care programme is recommended.

- 1 Press the Power button.
- 2 Select a washing programme.
- 3 Press the Crease Care button for three seconds.
- 4 Press the Start/Pause button.

Temp.

The Temp. button selects the wash and rinse temperature combination for the selected programme. Press this button until the desired setting is lit. All rinses use cold tap water.

- Select the water temperature suitable for the type of load you are washing. Follow the garment fabric care labels for best results.

Spin

- Spin speed level can be selected by pressing the Spin button repeatedly.
- Spin Only

- 1 Press the Power button.

2 Press the Spin button to select RPM.

3 Press the Start/Pause button.

NOTE

- When you select No(0, No Spin), it will still rotate for a short time to drain quickly.

Rinse

Rinse+ () Add rinse once.

Add Item ()

Laundry can be added or removed after the washing programme is started.

1 Press the Add Item button when the LED is turned on.

2 Add or remove laundry.

3 Close the door and Press the Start/Pause button.

NOTE

- For safety reasons, the door remains locked when the water level or temperature is high. It is not possible to add laundry during this time.
- If the water temperature in the drum is high, wait until it cools down.

CAUTION

- When adding laundry, make sure to completely push it into the drum. If laundry gets stuck in the door latch hole, the rubber packing may be damaged, causing water leakage and malfunction.
- Forcing the door open may cause part damage, destruction, or safety problems.
- If you open the door while there are a lot of suds and water in the drum, the suds or water may flow, causing burn injury or wet floor.

Child Lock

Use this option to disable the controls. This feature can prevent children from changing cycles or operating the appliance

Locking the Control Panel

1 Press and hold the Child Lock button for three seconds.

2 A beeper will sound, and CL will appear on the display. When the Child Lock is set, all buttons are locked except the Power button.

NOTE

- Turning off the power will not reset the child lock function. You must deactivate child lock before you can access any other functions.

Unlocking the Control Panel

Press and hold the Child Lock button for three seconds.

- A beeper will sound and the remaining time for the current programme will reappear on the display.

Beep On / Off

1 Press the Power button.

2 Press the Start/Pause button.

3 Press and hold the Temp. and Delay End button simultaneously for 3 seconds to set the Beep on/off function.

NOTE

- Once the Beep on/off function is set, the setting is memorized even after the power is turned off.
- If you want to turn the Beeper off, simply repeat this process.

Dry

Use the automatic programmes to dry most loads. Electronic sensors measure the temperature of the exhaust to increase or decrease drying temperatures for faster reaction time and tighter temperature control.

- Cold water tap must be left on during drying programmes.
- This washing machine's automatic process from washing to drying can be selected easily.
- For most even drying, make sure all articles in the clothes load are similar in material and thickness.
- Do not overload the washing machine by stuffing too many articles into the drum. Items must be able to tumble freely.
- If you open the door and remove the load before the washing machine has finished its cycle, remember to press the Start/Pause button.
- By pressing the Dry button, you can select: Normal-Time (30-60-90-120-150)-Iron-Low Temp.-Normal Eco.
- After the end of dry, ' Cd ' is displayed. ' Cd ' means crease decreasing. The drying cycle is already done. Press any buttons and take out clothes. If you do not press the Start/Pause button, the programme ends after about 4 hours.

NOTE

- When you turn the washing machine off of the drying cycle, the drying fan motor can be operated to save itself for 30 seconds. Then the washing machine will display ' CF ' on the panel. ' CF' means cooling fan.

- Be careful when removing your clothing from the washing machine, as the clothing or washing machine may be hot.

Woolen Articles

- Do not tumble dry woolen articles. Pull them to their original shape and dry them flat.

Woven and Loopknit Materials

- Some woven and loopknit materials may shrink, by varying amounts, depending on their quality.
- Always stretch these materials out immediately after drying.

Permanent Press and Synthetics

- Do not overload your washing machine.
- Take out permanent press articles as soon as the washing machine stops to reduce wrinkles.

Baby Clothes and Night Gowns

- Always check the manufacturer's instructions.

Rubber and Plastics

- Do not dry any items made from or containing rubber or plastics, such as:
 - aprons, bibs, chair covers
 - curtains and table cloths
 - athmats

Fiber Glass

- Do not dry fiberglass articles in your washing machine. Glass particles left in the washing machine may be picked up by your clothes the next time you use the washing machine and cause skin irritation.

Drying Time Guide

- The drying time can be selected by pressing the Dry button.
- Drying programme can last up to about 7 hours.
- These drying times are given as a guide to help you set your washing machine for manual drying.

NOTE

- The estimated drying time varies from the actual drying time during the Automatic programme. The type of fabric, size of the load, and the dryness selected affect drying time.
- When you select drying only, spinning runs automatically for energy efficiency.

SMART FUNCTIONS

Using Smart ThinQ Application

Installing Smart ThinQ

Search for the LG Smart ThinQ application from the Google Play Store on a smart phone. Follow instructions to download and install the application.

Tag On Function

- For appliances with the  logo
- The Tag On function can only be used with most smart phones equipped with the NFC (Near Field Communication) function and based on the Android OS (operating system).

Download Cycle

Download new and special cycles that are not included in the basic cycles on the appliance. Appliances that have been successfully registered can download a variety of specialty cycles specific to the appliance. Only one cycle can be stored on the appliance at a time. Once cycle download is completed in the appliance, the product keeps the downloaded cycle until a new cycle is downloaded.

Tub Clean Coach

This function shows how many cycles remain before It is time to run the Tub Clean cycle.

Smart Diagnosis™

This function provides useful information for diagnosing and solving issues with the appliance based on the pattern of use.



Settings

Set the product nickname and delete product.

NOTE

- Press  in the LG Smart ThinQ application for a more detailed guide on how to use the Tag On function.
- The location of the smartphone's NFC module may vary depending on the phone, and NFC use may be restricted on some smartphones due to differences in transmission methods. Because of the characteristics of NFC, if the transmission distance is too far, or if there is a metal sticker or a protective case on the phone, transmission will not be good. In some cases, NFC-equipped phones may be unable to transmit successfully.
- The content found in this manual may differ from the current version of the LG Smart ThinQ application, and the software may be modified without informing customers.
- NFC function would vary depending on smart phones.

Smart Diagnosis™ Using a Smart Phone

- For appliances with the  or  logo Use this function if you need an accurate diagnosis by an LG Electronics customer information centre when the appliance malfunctions or fails.
- Smart Diagnosis™ can not be activated unless the appliance is connected to power. If the appliance is unable to turn on, then troubleshooting must be done without using Smart Diagnosis™.

Using Smart Diagnosis™

Smart Diagnosis™ Through the Customer Information Centre

Use this function if you need an accurate diagnosis by an LG Electronics service centre when the product malfunctions or fails. Use this function only to contact the service representative, not during normal operation.

1 Press the Power button to turn on the washing machine. Do not press any other buttons or turn the programme selector knob.

2 When instructed to do so by the call centre, place the mouthpiece of your phone close to the Power button.

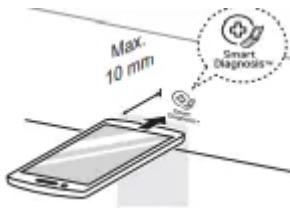

3 Press and hold the Temp. button for three seconds, while holding the phone mouthpiece to the icon or Power button.

4 Keep the phone in place until the tone transmission has finished. Time remaining for data transfer is displayed.

- For best results, do not move the phone while the tones are being transmitted.
- If the call centre agent is not able to get an accurate recording of the data, you may be asked to try again. LG Electronics service centre



5 Once the countdown is over and the tones have stopped, resume your conversation with the call centre agent, who will then be able to assist you using the information transmitted for analysis.

NOTE

- The Smart Diagnosis™ function depends on the local call quality.
- The communication performance will improve and you can receive better service if you use the home phone.
- If the Smart Diagnosis™ data transfer is poor due to poor call quality, you may not receive the best Smart Diagnosis™ service.

MAINTENANCE

WARNING

- Unplug the washing machine before cleaning to avoid the risk of electric shock. Failure to follow this warning may result in serious injury, fire, electric shock, or death.
- Never use harsh chemicals, abrasive cleaners, or solvents to clean the washing machine. They may damage the finish.

Cleaning Your Washing Machine

Care After Wash

- After the cycle is finished, wipe the door and the inside of the door seal to remove any moisture.
- Leave the door open to dry the drum interior.
- Wipe the body of the washing machine with a dry cloth to remove any moisture.



Cleaning the Exterior

Proper care of your washing machine can extend its life.

Door:

- Wash with a damp cloth on the outside and inside and then dry with a soft cloth.

Exterior:

- Immediately wipe off any spills.
- Wipe with a damp cloth.
- Do not press the surface or the display with sharp objects.

Cleaning the Interior

- Use a towel or soft cloth to wipe around the washing machine door opening and door glass.
- Always remove items from the washing machine as soon as the cycle is complete. Leaving damp items in the washing machine can cause wrinkling, colour transfer, and odour.
- Run the Tub Clean programme once a month (or more often if needed) to remove detergent buildup and other residue

Cleaning the Water Inlet Filter

- Turn off the supply taps to the machine if the washing machine is to be left for any length of time (e.g. holiday), especially if there is no floor drain (gully) in the immediate vicinity.
- icon will be displayed on the control panel when water is not entering the detergent drawer.
- If water is very hard or contains traces of lime deposit, the water inlet filter may become clogged. It is therefore a good idea to clean it occasionally.

1 Turn off the water tap and unscrew the water supply hose.



2 Clean the filter using a hard bristle brush.

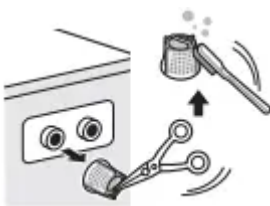

Cleaning the Drain Pump Filter

- The drain filter collects threads and small objects left in the laundry. Check regularly that the filter is clean to ensure smooth running of your washing machine.
- Allow the water to cool down before cleaning the drain pump, carrying out emergency emptying, or opening the door in an emergency.

1 Open the cover cap and pull out the hose.

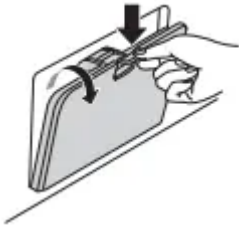

2 Unplug the drain plug and open the filter by turning it to the left.



3 Remove any extraneous matter from the pump filter.

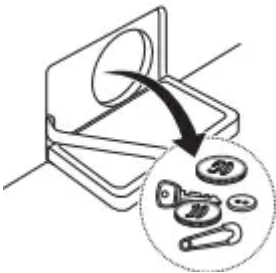

4 After cleaning, turn the pump filter and insert the drain plug.

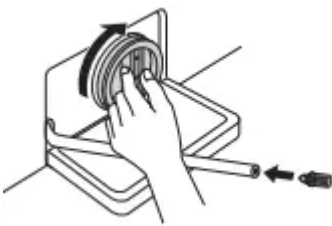

5 Close the cover cap.

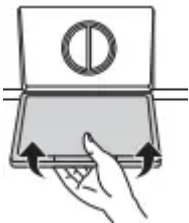

Cleaning the Dispenser Drawer

Detergent and fabric softener may build up in the dispenser drawer. Remove the drawer and inserts and check for buildup once or twice a month.

1 Remove the detergent dispenser drawer by pulling it straight out until it stops.

- Press down hard on the disengage button and remove the drawer.

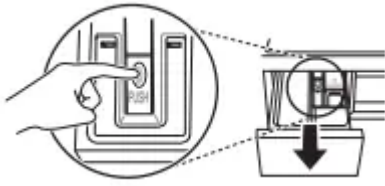

2 Remove the inserts from the drawer.

- Rinse the inserts and the drawer with warm water to remove buildup from laundry products. Use only water to clean the dispenser drawer. Dry the inserts and drawer with a soft cloth or towel.

3 To clean the drawer opening, use a cloth or small, non-metal brush to clean the recess.

- Remove all residue from the upper and lower parts of the recess.

4 Wipe any moisture off the recess with a soft cloth or towel.

5 Return the inserts to the proper compartments and replace the drawer.

Tub Clean () (Optional)

Tub Clean is a special programme to clean the inside of the washing machine.

A higher water level is used in this programme at higher spin speed. Perform this programme regularly.

1 Remove any clothing or items from the washing machine and close the door.

2 Open the dispenser drawer and add antilimescale to the main wash compartment.

- For tablets put into the drum.

3 Close the dispenser drawer slowly.

4 Power on and then press and hold Tub Clean button for 3 seconds. Then  will be displayed on the display.

5 Press the Start/Pause button to start.

6 After the programme is complete, leave the door open to allow the washing machine door opening, flexible gasket and door glass to dry

Caution on Freezing During Winter

- When frozen, the product does not operate normally. Make sure to install the product where it will not freeze during winter.
- In case the product must be installed outside on a porch or in other outdoor conditions, make sure to check the following.

How to Keep the Product from Freezing

- After washing, remove water remaining inside the pump completely with the opening hose plug used for removal of residual water. When the water is removed completely, close the hose plug used for removal of residual water and cover cap.

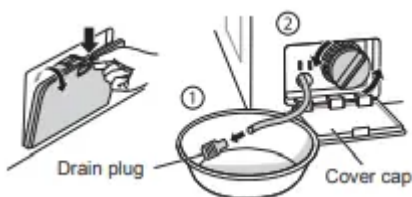

- Hang down drain hose to pull out water inside the hose completely.

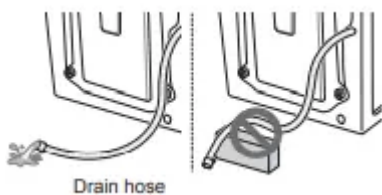

CAUTION

- When the drain hose is installed in a curved shape, the inner hose may freeze.
- After closing the tap, disconnect the cold supply hose from the tap, and remove water while keeping the hose facing downwards.

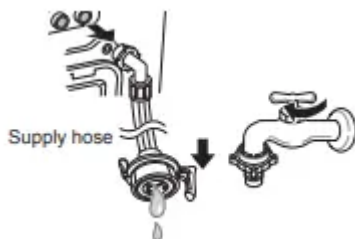

Check for Freezing

- If water does not drain when opening the hose plug used for removal of residual water, check the drainage unit.



- Turn the power on, choose a washing programme, and press the Start/Pause button.

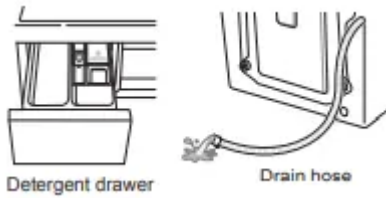

- When 'FF' is shown in display window while the product is in operation, check water supply unit and drainage unit (Some models do not have an alarm function that indicates freezing).

NOTE

- Check that water is coming into the detergent drawer while rinsing, and water is draining through the drain hose while spinning.

How to Handle Freezing

- Make sure to empty the drum, pour warm water of 50–60 °C up to the rubber part inside the drum, close the door, and wait for 1–2 hours. 50-60 °C



CAUTION

- When the drain hose is installed in a curved shape, the inner hose may freeze.
- Open the cover cap and hose plug used for removal of residual water to extract water completely.

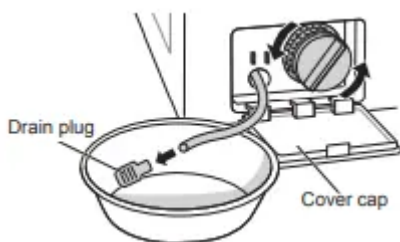

NOTE

- If water does not drain, this means the ice is not melted completely. Wait more.
- When water is removed completely from the drum, close the hose plug used for removal of residual water, choose a washing programme, and press the Start/Pause button.

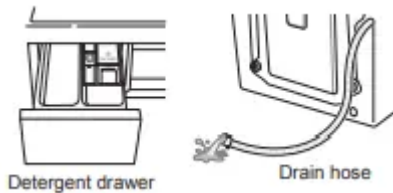

NOTE

- Check that water is coming into the detergent drawer while rinsing, and water is draining through the drain hose while spinning.
- When water supply problems occur, take the following measures.
 - Turn off the tap, and thaw out the tap and both connection areas of inlet hose of the product using a hot water cloth.
 - Take out inlet hose and immerse in warm water below 50–60 °C.

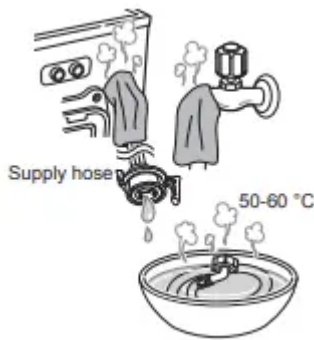

TROUBLESHOOTING

- Your washing machine is equipped with an automatic error-monitoring system to detect and diagnose problems at an early stage. If your washing machine does not function properly or does not function at all, check the following before you call for service:

Diagnosing Problems

Rattling and clanking noise

- Foreign objects such as coins or safety pins may be in drum or pump.
 - Check all pockets to make sure that they are empty. Items such as clips, matches, pens, coins, and keys can damage both your washer and your clothes.
 - Close zippers, hooks, and drawstrings to prevent these items from snagging or tangling on other clothes.



Thumping sound

- Heavy wash loads may produce a thumping sound. This is usually normal.
 - If sound continues, washing machine is probably out of balance. Stop and redistribute wash load.

Vibrating noise

- Have all the transit bolts and tub support been removed?
 - If not removed during installation, refer to Installation guide for removing transit bolts.
- Are all the feet resting firmly on the ground?
 - Make sure the washing machine is level and tighten the lock nuts up towards the base of the appliance.

Water leaks

- Supply hoses or drain hose are loose at tap or washing machine.
 - Check and tighten hose connections.
- House drain pipes are clogged.
 - Unclog drain pipe. Contact plumber if necessary.

Oversudsing

- Too much detergent or unsuitable detergent may cause excessive foaming which may result in water leaks.
 - Make sure that the suggested amount of detergent is used per the manufacturer's recommendations.

Water does not enter washing machine or it enters slowly

- Water supply is not adequate in that location.
 - Check another tap in the house.
- Water supply tap is not completely open.
 - Fully open tap.
- Water supply hose(s) are kinked.
 - Straighten hose.
- The filter of the supply hose(s) clogged.
 - Check the filter of the supply hose.

Water in the washing machine does not drain or drains slowly

- Drain hose is kinked or clogged.
 - Clean and straighten the drain hose.
- The drain filter is clogged.
 - Clean the drain filter.

Washing machine does not start

- Electrical power cord may not be plugged in or connection may be loose.
 - Make sure plug fits tightly in wall outlet.
- House fuse blown, circuit breaker tripped, or a power outage has occurred.
 - Reset circuit breaker or replace fuse. Do not increase fuse capacity. If problem is a circuit overload, have it corrected by a qualified electrician.
- Water supply tap is not turned on.
 - Turn on water supply tap.

Washing machine will not spin

- Check that the door is firmly shut.
 - Close the door and press the Start/ Pause button. After pressing the Start/ Pause button, it may take a few moments before the washing machine begins to spin. The door must be locked before spin can be achieved. Add 1 or 2 similar items to help balance the load. Rearrange load to allow proper spinning.

Door does not open

- Once washing machine has started, the door cannot be opened for safety reasons.
 - Check if the 'Door Lock' icon is illuminated. You can safely open the door after the 'Door Lock' icon turns off.

Wash cycle time delayed

- If an imbalance is detected or if the suds removing programme is on, the wash time will increase.
 - This is normal. The time remaining shown in the display is only an estimate. Actual time may vary.

Fabric softener overflow

- Too much softener may cause an overflow.
 - Follow softener guidelines to ensure appropriate amount is used. Do not exceed the maximum fill line.

Softeners dispensed too early

- Too much softener may cause an premature dispensing.
 - Follow the guidelines provided by the detergent manufacturer.
 - Close the dispenser drawer slowly. Do not open the drawer during the wash cycle.

Dry problem

- Check water supply tap.
 - Do not overload. Check that the washing machine is draining properly to extract adequate water from the load. Clothes load is too small to tumble properly. Add a few towels.
 - Turn off water supply tap.

Odor

- This odor is caused by the rubber attached to the washing machine.
 - It is the normal odor of new rubber and will disappear after the machine has been run a few times.
- If the rubber door gasket and door seal area are not cleaned regularly, odors can occur from mold or foreign substances.
 - Be sure to clean the gasket and door seal regularly and check under the door seal for small items when unloading the washer.
- Odors can occur if foreign substances are left in the drainage pump filter.
 - Be sure to clean the drainage pump filter regularly.
- Odors can occur if the drainage hose is not properly installed, causing siphoning (water flowing back inside the washing machine).
 - When installing the drainage hose, be sure that it doesn't become kinked or blocked.
- Using the dry function, odors can occur from lint and other laundry matter sticking to the heater. (Dryer model only)
 - This is not a malfunction.
- A particular odor can occur from drying wet clothes with hot air. (Dryer model only)
 - The odor will disappear after a short while.

Error Messages



- Water supply is not adequate in area.
 - Check another tap in the house.
- Water supply taps are not completely open.
 - Fully open tap.
- Water supply hose(s) are kinked.
 - Straighten hose(s).
- The filter of the supply hose(s) are clogged.
 - Check the filter of the supply hose.
- If water leakage occurred in the aqua stop supply hose, indicator A will become red.



May vary depending on the model.

- Use the aqua stop supply hose.



- Load is too small.
 - Add 1 or 2 similar items to help balance the load.
- Load is out of balance.
 - Add 1 or 2 similar items to help balance the load.
- The appliance has an imbalance detection and correction system. If individual heavy articles are loaded (e.g. bath mat, bath robe, etc.) this system may stop spinning or even interrupt the spin cycle altogether.
 - Rearrange load to allow proper spinning.
- If the laundry is still too wet at the end of the cycle, add smaller articles of laundry to balance the load and repeat the spin cycle.
 - Rearrange load to allow proper spinning.



DE

- Drain hose is kinked or clogged.
 - Clean and straighten the drain hose.
- The drain filter is clogged.
 - Clean the drain filter.



dE

dE1

dE2

- Ensure door is not open.
 - Close the door completely. If dE , dE1 , dE2 is not released, call for service.

tE

tE

- Control error.
 - Unplug the power plug and call for service.

FE

FE

- Water overfills due to the faulty water valve.
 - Close the water tap.
 - Unplug the power plug.
 - Call for service.

PE

PE

- Malfunction of water level sensor.
 - Close the water tap.
 - Unplug the power plug.
 - Call for service.

LE

LE

- Over load in motor.
 - Allow the washing machine to stand for 30 minutes to allow the motor to cool, then restart the cycle.

AE

AE

- Water leaks.
 - Call for service.

dHE

- Does not dry
 - Call for service.

Warning

This content is compiled from multiple sources and is provided for reference purposes only. It may not be complete or fully applicable to all situations. If you are unable to resolve your issue, please contact the product manufacturer or an authorized service provider for official support.