

PRODUCT DESCRIPTION

Parts

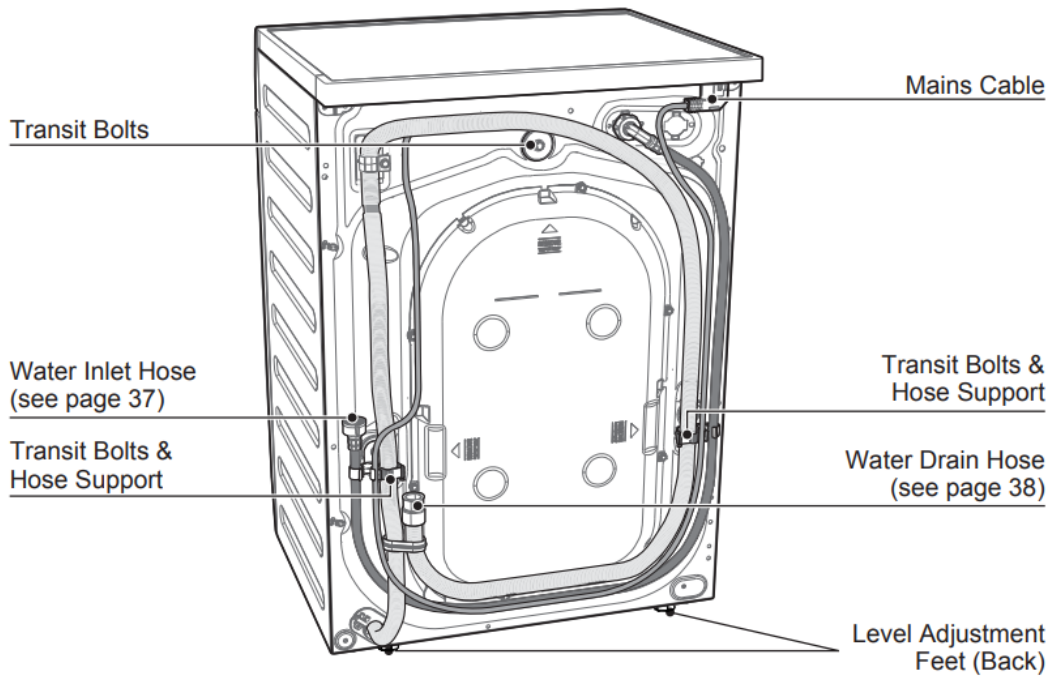

Detergent/Softener Dispenser (For more informations, see page 18)

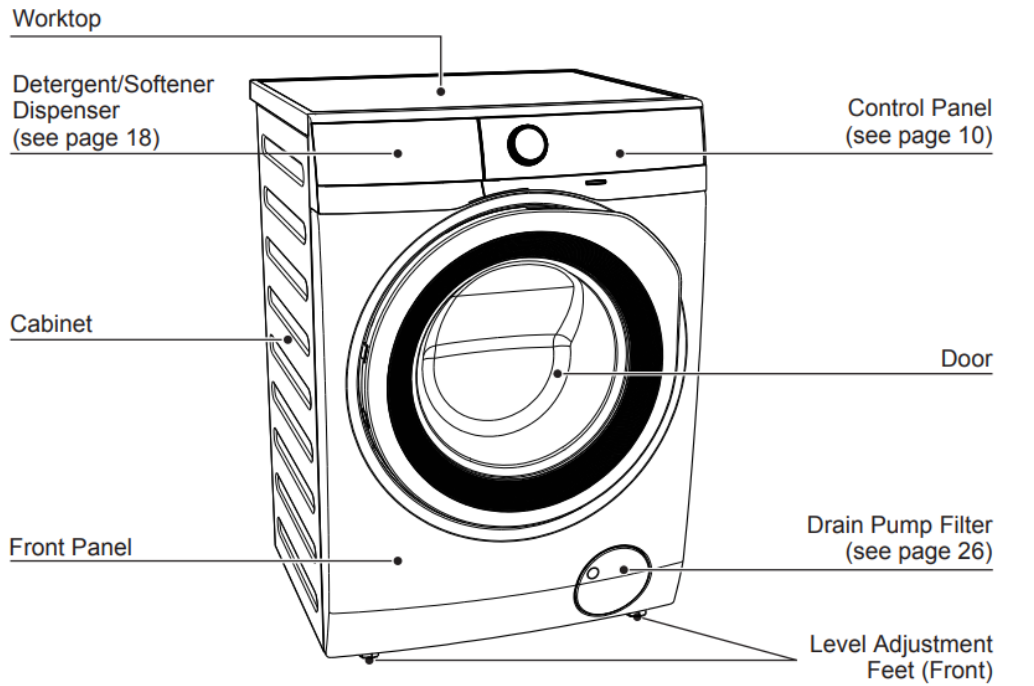

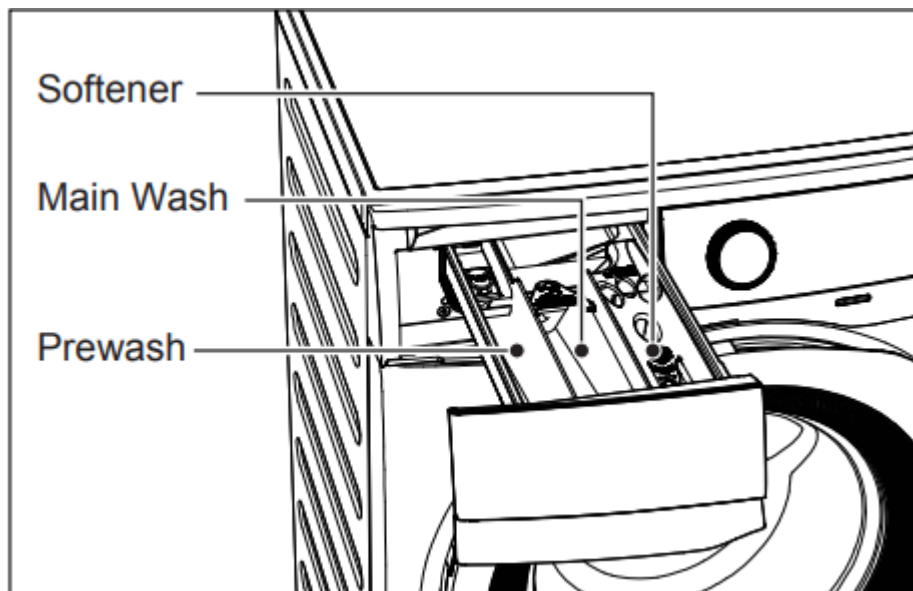

Door (when open) (for more informations, see page 18)

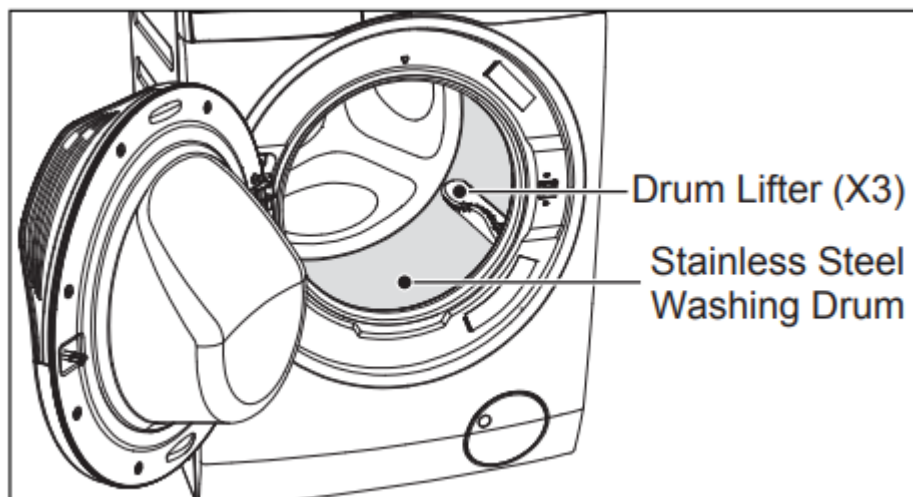

Drain Pump Filter (when open)

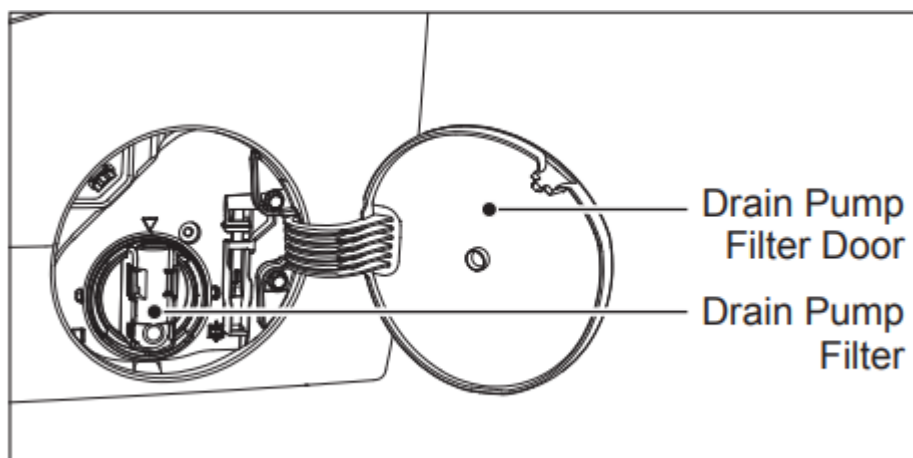

Level Adjustment Feet

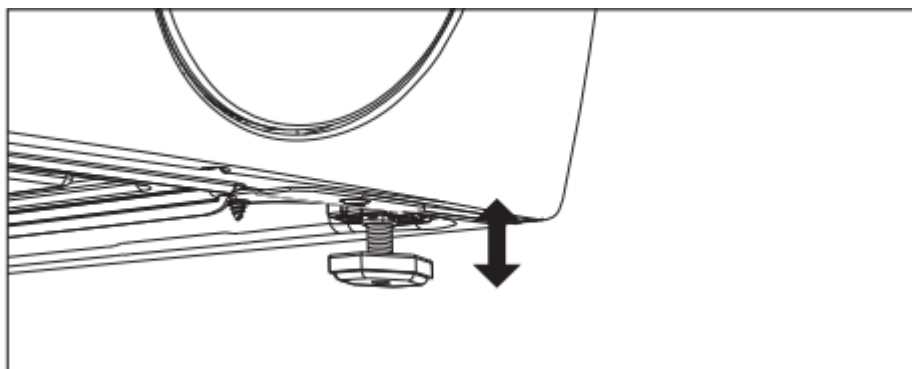

Transit Bolt (when remove)

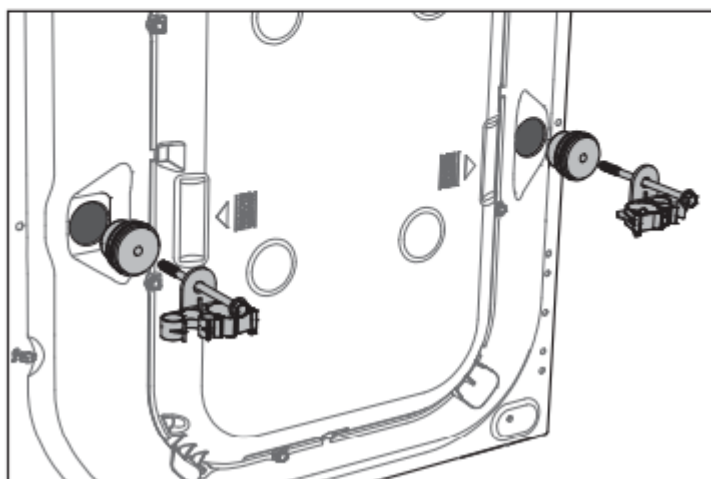
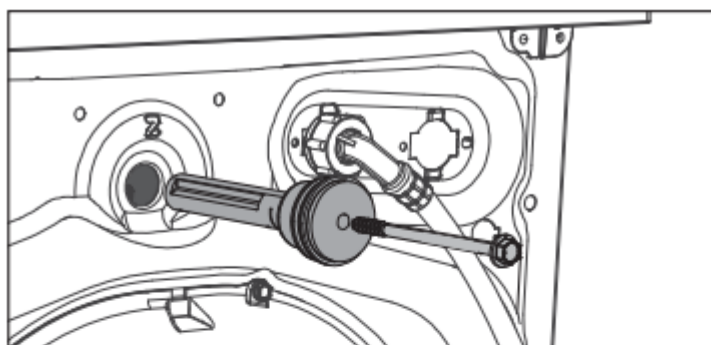

Transit bolts must be removed before using the appliance.



CONTROL PANEL

Control Panel Description

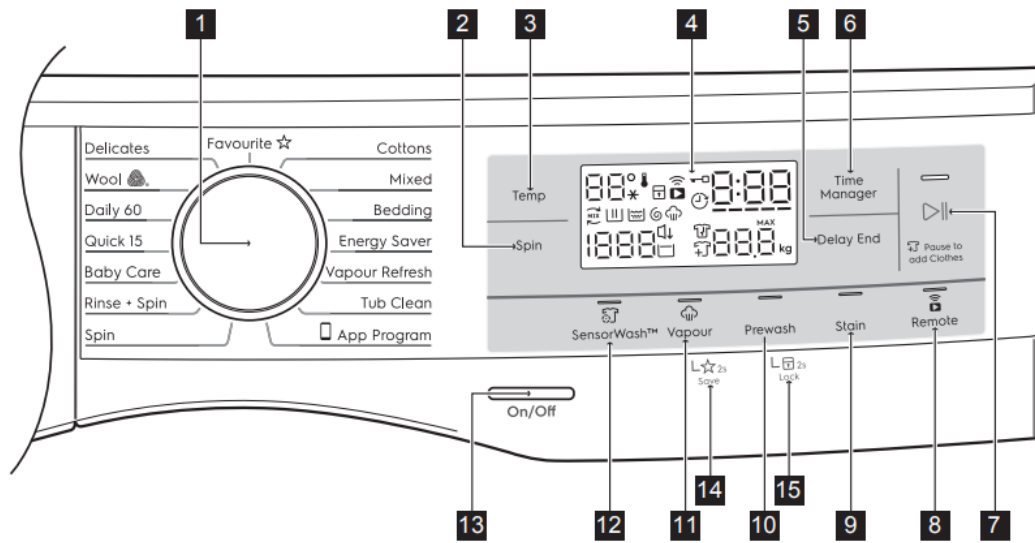

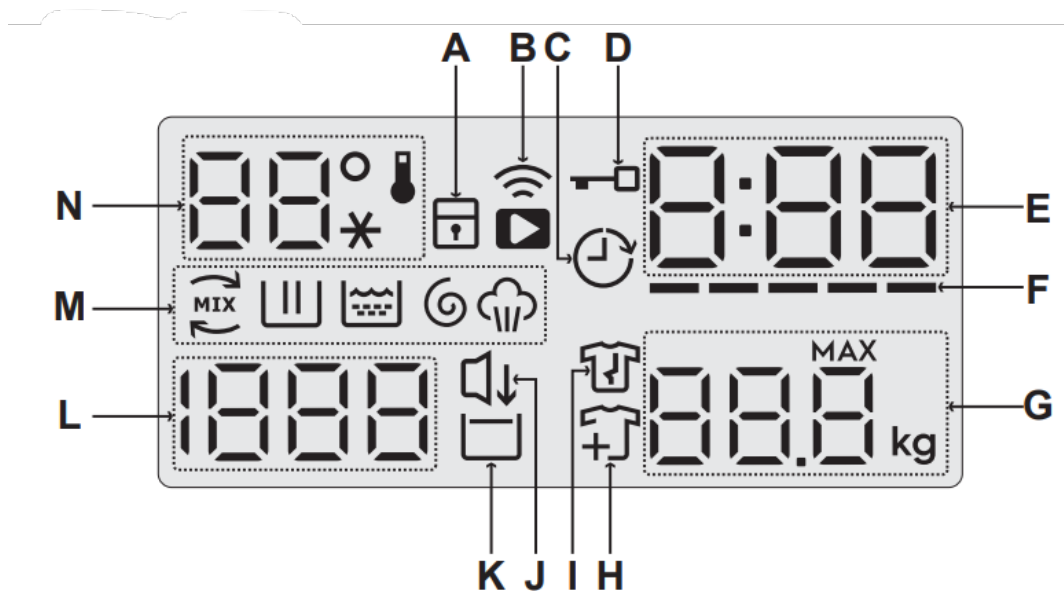

1. Program Selector Knob
2. Spin Selection Touchpad
3. Temperature Selection Touchpad
4. Display
5. Delay End Touchpad
6. Time Manager Touchpad
7. Start/Pause and Add Clothes Touchpad
8. Remote Touchpad
9. Stain Touchpad
10. Prewash Touchpad
11. Vapour Touchpad
12. Sensor Wash Touchpad
13. On/Off Button
14. Save Favourite Program Option
15. Child Lock Option



- A. Child Lock Icon
- B. Remote Icon
- C. Delay End Icon
- D. Door Lock Icon
- E. Program Time
- F. Time Manager Level
- G. Maximum Load Capacity Of Selected Program
- H. Add Clothes Icon
- I. Antcrease Phase Icon
- J. Extra Silent Icon
- K. Rinse Hold Icon
- L. Spin Speed

M. Program Phase Indication Icon:



-  Ultramix phase
-  Wash phase
-  Rinse phase
-  Spin phase



Vapour phase

N. Temperature

Program Chart

Program; Temperature range	Max. Spin Speed	Max. Load (Dry Clothes)	Type of load and soil level
Cottons; Cold to 90°C	1400 rpm	10 kg	White and coloured cotton. (Adjust wash time according to soil level. See Time Manager table on page 13)
Mixed; Cold to 60°C	1200 rpm	4 kg	Synthetic or mixed fabric items. (Adjust wash time according to soil level. See Time Manager table on page 13)
Bedding; Cold to 60°C	800 rpm	3 kg	Special program for one synthetic blanket, duvet, bedspread and so on. (Adjust wash time according to soil level. See Time Manager table on page 13)
Energy Saver; 40°C ¹⁾ and 60°C	1400 rpm	10 kg	White and colourfast cotton. Set this program to have a good washing results and decrease the energy consumption. The time of the washing program is extended.
Vapour Refresh	–	1.5 kg	This cycle removes odours and helps to dewrinkle the laundry.  Do not add detergent.
Tub Clean	–	–	For cleaning the tub.
 App Program	–	–	You can send any additional program from Mobile Application to store at this program position and can recall to using it everytime when you rotate program knob to this position. This can be done through the App.  Program "Outdoor" is the default stored program from factory.
Spin	1400 rpm	10 kg	To spin the laundry and drain the water in the drum.
Rinse + Spin	1400 rpm	10 kg	To rinse and spin the laundry.
Baby Care; Cold to 40°C	1200 rpm	4 kg	Baby cotton clothes and delicate knitting items with normal soil.
Quick 15; 30°C	800 rpm	1.5 kg	Lightly soiled synthetics or mixed fabrics.
Daily 60; 30°C to 60°C	1400 rpm	5.5 kg	Coloured cotton e.g. shirts, blouses, towels and undergarments with normal level of soil.

Program; Temperature range	Max. Spin Speed	Max. Load (Dry Clothes)	Type of load and soil level
Wool  ; Cold to 40°C	1200 rpm	2 kg	Specially tested program for woollen garments bearing the "Pure new woollen, non-shrink, machine washable" label.
Delicates; Cold to 40°C	1200 rpm	4 kg	Delicate fabrics such as acrylics, viscose, polyester items. (Adjust wash time according to soil level. See Time Manager table on page 13)
Favourite	–	–	Recall you favourite program.









1) Energy Saver program with 40degC and 1400rpm is recommended for a full load of normally soiled cottons, and is the Water and Energy rating label program.

Woolmark Apparel Care - Blue



- The wool wash cycle of this machine has been approved by The Woolmark Company for the washing of wool garments labelled as "hand wash" provided that the garments are washed according to the instructions issued by the manufacturer of this washing machine. Follow the garment care label for drying and other laundry instructions. M1361
- The Woolmark symbol is a Certification mark in many countries.

Program Options Compatibility

Program	Option								
	 No Spin	 Rinse Hold	 Extra Silent	 Time Manager	 Delay End	 Sensor Wash	 Vapour ¹⁾	 Prewash	 Stain
Cottons	○	○	○	○	○	○	○	○	○
Mixed	○	○	○	○	○	○	○	○	○
Bedding	○	×	×	○	○	○	○	×	○
Energy Saver	○	○	×	×	○	×	○	○	○
Vapour Refresh	×	×	×	×	○	×	○	×	×
Tub Clean	×	×	×	×	×	×	×	×	×
App Program	-	-	-	-	-	-	-	-	-
Spin	○	×	×	×	○	×	×	×	×
Rinse + Spin	○	○	×	×	○	×	×	×	×
Baby Care	○	○	○	×	○	○	○	○	○
Quick 15	○	○	×	×	○	×	×	×	×
Daily 60	○	○	×	×	○	×	×	×	×
Wool	○	○	○	×	○	×	×	×	×
Delicates	○	○	○	○	○	○	○	○	○
Favourite	-	-	-	-	-	-	-	-	-

1) Vapour option can be combined with temperature 40 to 90 °C only.



Options



Temperature Touchpad

- Press this touchpad repeatedly to increase or decrease the wash temperature if you want your laundry to be washed at a temperature different from the one proposed by the washing machine.

Spin Selection Touchpad

Press this touchpad repeatedly to increase or decrease the spin speed or select Rinse Hold, if you want your laundry to be spun at a speed different from the one proposed by the washing machine.

- No Spin (---): No spin option eliminates all the spin phases and increase the number of rinses.
- Rinse Hold ():
 - By selecting this option the water of the last rinse is not emptied out and the drum turns regularly to prevent the laundry creases.
 - The door is still locked to indicate that the water must be emptied out.
 - The door stays locked with the water in the drum. To continue the cycle, you must press  (Start/Pause).

- Extra Silent ()
 - By selecting this option, the machine will not drain the water of the last rinse to avoid wrinkling the laundry. All spinning phases are suppressed.
 - This washing cycle is very quiet, and can be selected at night or other appropriate times.
 - The door stays locked with the water in the drum. To continue the cycle, you must press  (Start/Pause).

Time Manager

This option allows you to adjust the wash time. Press this touchpad repeatedly to decrease or increase the wash time according to the soil level of your wash. Use the table below as a guide.

Soil Level				
Lightly	Light	Medium	Normal	Heavy
-	--	---	----	-----

Time Manager function is not available when is on.

Delay End () Touchpad

- Before you start the program, this option makes it possible to define the end of the washing program from minimum of 1 hour to maximum of 20 hours.
- If program duration is longer than 3 hours, minimum Delay End option starts from 4 hours.
- Press the Delay End touchpad to choose the end time as you wish. The display shows the number of hours and the indicator beside the touchpad is on.
- This option must be selected after choosing the wash program, and before pressing the “Start/Pause” touchpad.
- For example, if the program duration of your selected program is 3.20 hours and you define the “Delay End” time to 6 hours. This means your wash program will finish in 6 hours. (See diagram)

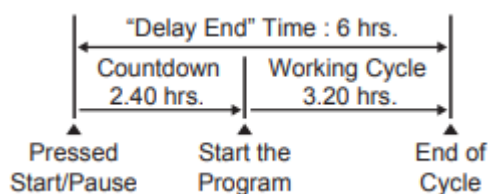

- After selecting Delay End time, press Start/Pause touchpad to start the program. Machine will then countdown and update time on the display every hours until it reaches the starting point of the wash cycle.

- If you wish to modify or cancel Delay End option after starting the program, follow the steps below:
 - set the washing machine to PAUSE by pressing “Start/Pause” touchpad;
 - deselect this option by pressing “Delay End” touchpad repeatedly till the display shows delay time “0h”;
 - press the “Start/Pause” to start the program.

Sensor Wash™ () Touchpad

- Press touchpad to toggle wash and rinse sensor of the machine.
- The machine will automatically detect soil level and give the number of rinse to your wash for a better wash and rinse performance.
- So, you will get the perfect care for you favourite clothes, with less colour fading and minimal textural damage.

Vapour () Touchpad

Select this option to add approximately 30 minutes of tumbling in vapour during the wash cycle. Vapour helps open fabric fibers up to allow laundry additives to release tough stains. The indicator of this option will be on.

- Vapour may not necessarily be visible inside the drum during a vapour wash cycle. Vapour is created below the drum and allowed to naturally rise into the clothes.
- Vapour may not be present during the entire vapour wash cycle.
- Vapour function is more effective with half load.
- At the end of the Vapour cycle, the clothes will be warmer, softer and detached from the drum.

Prewash () Touchpad

- Select this option if you wish your laundry to be pre-washed before the main wash. Use this option for heavy soil. The indicator of this option will be on
- When you set this function, put the detergent into the “” compartment.
- This function increases the program duration.

Stain Touchpad

- Press this touchpad to add the stain phase to a program. The indicator of this option comes on.
- Use this function for laundry with hard stains to remove.
- When you set this function, put the stain remover into “” compartment. (Refer page 18)

Remote () Touchpad

- This option allows you to connect washing machine to Wi-Fi network and to link it to your smart phone.
- By this functionality you can receive notifications, control and monitor your washing machine from your mobile devices.
- To connect the washing machine with your smart phone you need:
 - Wireless network at home with internet connection enabled.
 - Smart Phone connected to wireless network.

Installing the application “Electrolux Life”

When connecting the washing machine to the application, stand near it with your smart phone (Android or iOS). Make sure that your smart phone is connected to the wireless network

1. Go to the App Store on your smart phone.
2. Download and install the App “Electrolux Life”.
3. Start the application. Select the country and language and login with your email and password. If you do not have an account, create a new one following the instructions in “Electrolux Life”.

Configuring the washing machine wireless connection

1. On the App Homepage tap on “Appliances” on the bottom of the home screen
2. On the App tap on “Add Appliance” and “YES”. Choose “WASHER” in the drop down menu and tap “CONTINUE”
3. Turn on your washing machine Wi-Fi by pressing and hold “Remote ()” touchpad for 3 seconds to enable wireless connection and you hear a double beep sound
 - When LED is lit the product is connected.
 - When LED is flashing the product is connecting
 - When LED is off, Wi-Fi connectivity is off. Press and hold this touchpad for 10 seconds to reset wireless connection
4. Connect your appliance to your device.
 - For Android device, select your appliance’s Wi-Fi network from the drop down list.
 - For iOS device go to “SETTINGS” and select your appliance’s Wi-Fi network, then return to this screen

Please note it might take up to one minute for the appliance’s Wi-Fi network to display.

Connect your washing machine to your home Wi-Fi by selecting the network name and inputting your home Wi-Fi password.

Once the connection is successfully established, the Wi-Fi button will stop flashing and you will hear a beep sound.

To complete the product registration, add your washing machine name and purchase date on the App.

Disabling / Resetting the washing machine wireless connection

1. You can temporarily disable the Wi-Fi connection by pressing and holding for 3 seconds the CONNECT button. The Wi-Fi icon will switch off and you will hear a beep sound. Once the Wi-Fi connection is disabled, to re-establish the connection you will have to press and hold for the 3 seconds the CONNECT button again.
2. You can reset the Wi-Fi configuration by pressing and holding for 10 seconds the CONNECT button. Once the configuration is reset, to re-establish the connection, you will have to repeat all the steps at section “Configuring the washing machine wireless connection”

Settings

Save Favourite (☆) Program

Program settings that are frequently used can be saved (e.g. Cotton, 60°C, 1200 rpm, with Prewash and Vapour).

To program/re-program Favourite with your own selections and save them, proceed as follows:

1. Put machine in Stand-By mode.
2. Select your desired wash settings.
3. To save favourite program, press and hold “Vapour ” touchpad about 2 seconds and you will hear “Bip, Bip” sound and “Favourite” LED is flashing.

To recall the favourite wash program, turn selector knob to “Favourite ☆” program. You will get acknowledgement on the screen when the Favourite program is loaded.

App Program cycle cannot be saved as a Favourite on the appliance.

Child Safety Lock () Option

Your appliance is provided with CHILD SAFETY LOCK which permits you to leave the appliance unsupervised with the door closed without having to worry that children might be injured by or cause damage to the appliance.

Set this option after pressing the Start/Pause touchpad.

To set “Child Lock” option:

- To activate the function, press and hold “Prewash” touchpad about 2 seconds until the display shows the icon “”.

If you press any touchpad while Child Lock is activated, the icon “” will flash on display 3 times along with buzzer sound.

The touchpads are locked (except for the On/Off button)





- To deactivate the function, press and hold “Prewash” touchpad about 2 seconds until the icon “” goes off.

This function remains enabled even after the appliance is switched off.

Enabling/Disabling End-Of-Wash Buzzer

This setting permits you to either enable or disable the buzzer at the end of the program. As an example, you might wish to disable this buzzer when you start a wash when going to bed, so that when the wash finished approximately 1 hour later, it will not disturb you through the night.

Error warning beeps such as critical faults are not disabled.

- To disable the buzzer sound, press “SensorWash () and Vapour ()” touchpads at the same time about 3 seconds, the icon “  ” will show on display along with buzzer sound.
- To return to default configuration press these 2 touchpads at the same time about 3 seconds, the icon “  ” will show on display along with buzzer sound.

Start/Pause () and Add Clothes () Touchpad

This touchpad has 2 functions:

1. Start/Pause ()

- After you have selected the desired program and options, press this touchpad to start the machine. The Start/Pause pilot light will stop flashing and remain lit until the water level is above the bottom edge of the door then pilot light goes OFF. If you have selected a “Delay End” option, the countdown will begin and will be shown on the display.
- To interrupt a program which is running, press this touchpad to pause the machine, the Start/Pause pilot light flashes.
- To restart the program from the point at which it was interrupted, press this touchpad again, the Start/Pause pilot light will stop flashing.

2. Add Clothes ()

You can only add clothes when the icon “  ” shown on the display.

To add clothes:

1. Pressing the “Start/Pause” touchpad to pause the program
2. Wait for the machine to come to a complete stop before opening the door (wait for door lock “ ” icon to turn off).
3. Add clothing and close the door.
4. Resume the program by pressing “Start/Pause” touchpad again.

BEFORE FIRST USE

NOTE: During installation or before first use you may observe some water in the machine. This is a residual water left in the machine after a full functional test in the factory to ensure the machine is delivered to customers in perfect working order and is no cause for concern.

1. Ensure that the electrical and water connections comply with the installation instructions.
2. Put 2 litres of water in the detergent compartment for washing phase. This activates the drain system.
3. Select a Cottons cycle at 90 °C, without any laundry in the machine, to remove any manufacturing residue from the drum and tub then start the machine.

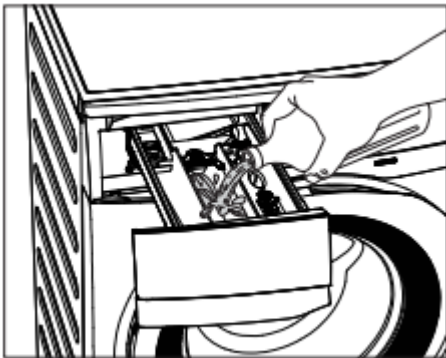

DAILY USE

Loading The Laundry

1. Turn the water tap on.
2. Connect the main plug to the main socket.
3. Press the On/Off button to turn on the washing machine. Turn the knob to set a program. The washing machine will propose a temperature and automatically select the spin value provided for the program you have chosen

The selector knob can be turned either clockwise or counter-clockwise.

4. Check and remove objects (if there are any) that could be trapped in the fold.

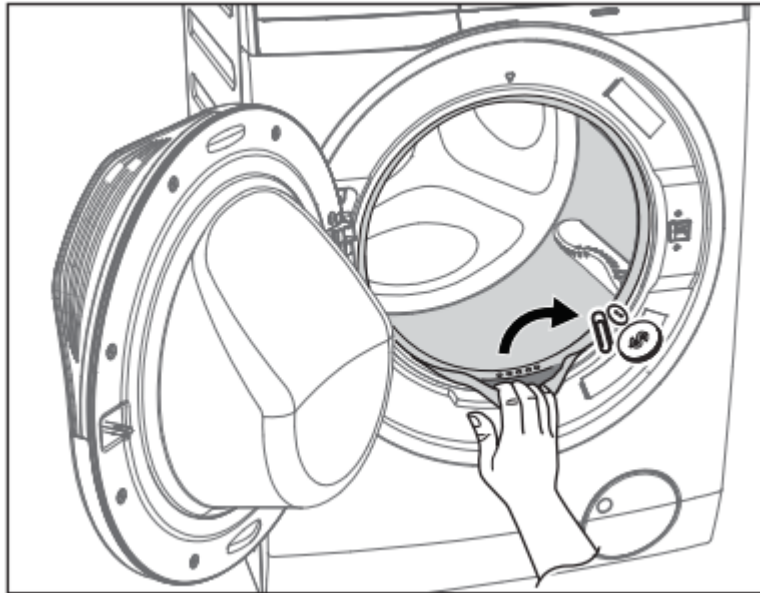

5. Place the laundry in the drum, one item at a time, shaking them out as much as possible. (Refer to page 22 “WASHING HINTS”)

6. Close the door.

Make sure that no laundry remains between the seal and the door.

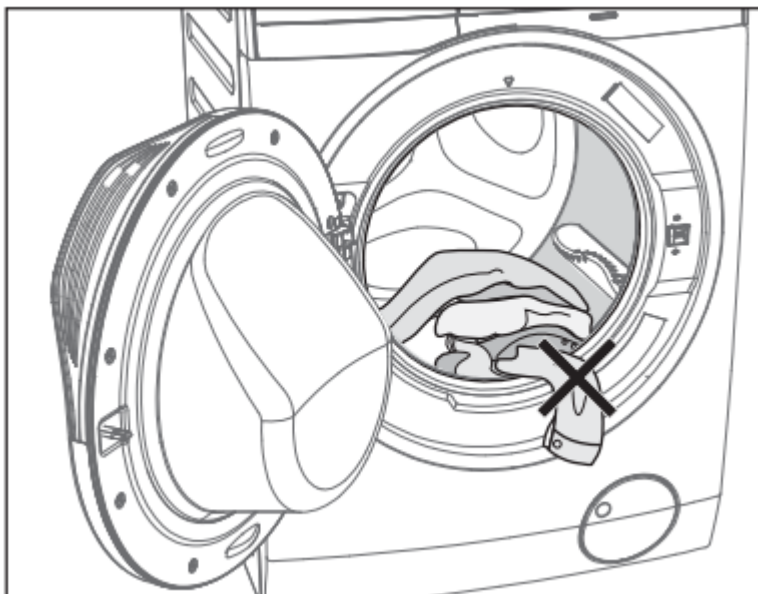



Using Detergent And Additives

Please read “Detergents Type and Quantity of Detergent” on page 23 before use.

1. Detergent Dispenser Drawer

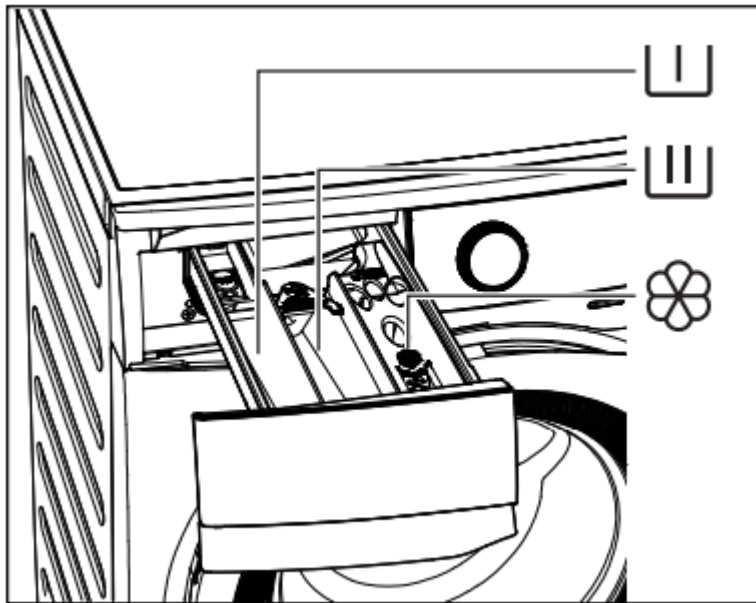
The detergent dispenser is divided into three compartments.



- 
 Compartment "PREWASH": This compartment is used for fabric conditioner and starching agent. This compartment is only used for detergent when a "Prewash" option is selected.
- 
 Compartment "MAIN WASH": This compartment is used for detergent on all programs.

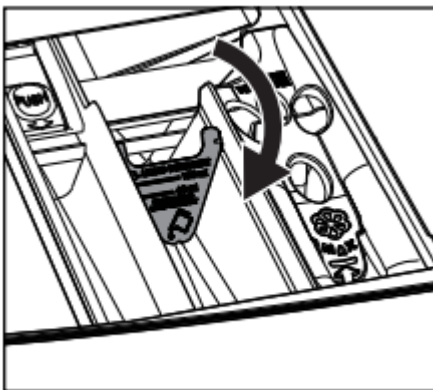

Position down: for liquid detergent.

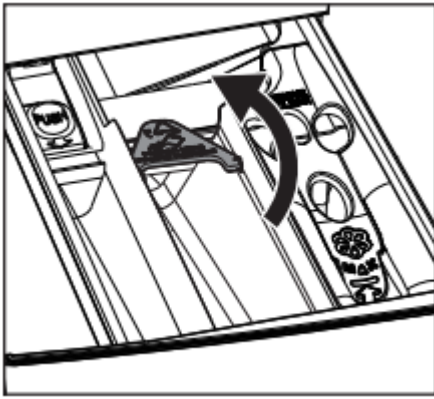

Position up: for powder detergent.



Compartment "SOFTENER": Compartment "PREWASH" This compartment is used for fabric conditioner and starching agent.

NOTE: When you use the liquid detergent

- Do not use gelatinous or thick liquid detergents.
- Do not put more liquid than the maximum level.
- Do not set the "Prewash" phase.
- Do not set the "Delay End".

2. Measure out the detergent and the fabric softener;

- Pull out the dispenser drawer until it stops.
- Measure out the amount of detergent required, pour it into the main wash compartment

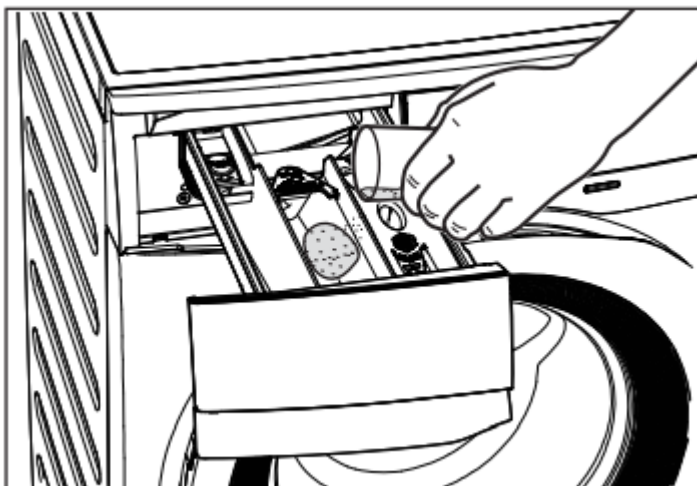

- If you wish to carry out the "Prewash" phase, pour it into the compartment marked .

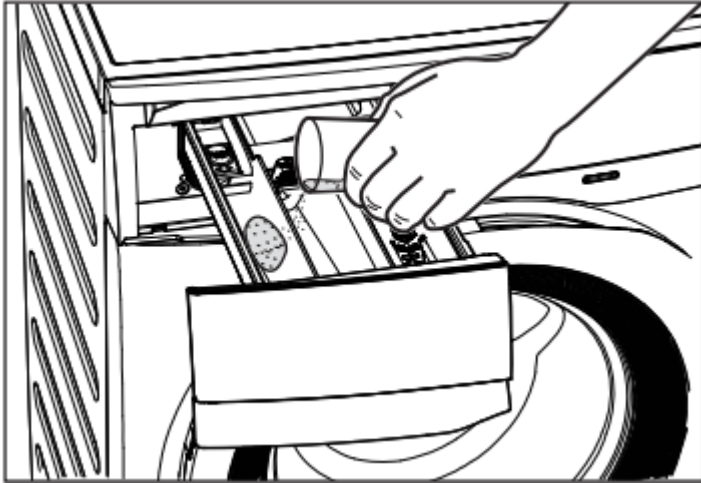

- If required, pour fabric softener into the compartment marked 

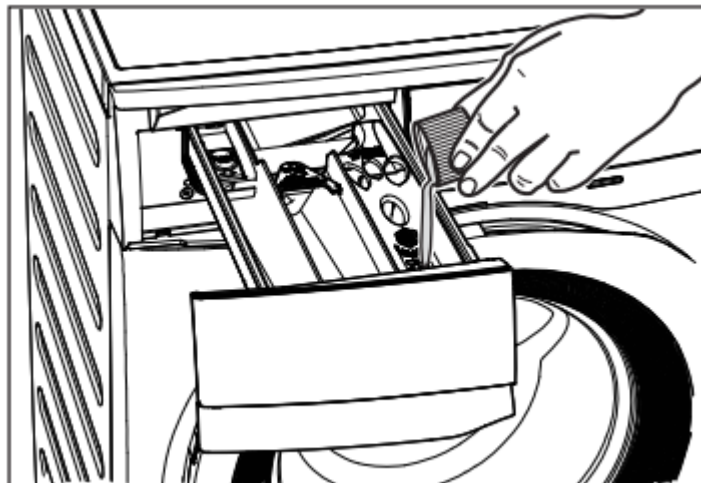

Options Setting

1. If you want your laundry to be spun or use temperature different from the one proposed by the washing machine, press “Spin” and “Temp” touchpads repeatedly to change the spin speed and temperature.

Press the option touchpads, if you want your laundry to be washed with special functions.

2. If you want to adjust washing time, press the “Time Manager” touchpad repeatedly to increase or decrease washing time. (See Time Manager guide on page 13)

If you want to define the end of the washing program, press the “Delay End” touchpad repeatedly to choose your washing machine working time.

Starting A Cycle (▶||)

To start a program, press the Start/Pause touchpad. The corresponding pilot light will stop flashing and a default program duration will be displayed on the screen.

After approx. 15 minutes from the start of a program:

- The appliance will automatically adjust the selected program duration according to the type and size of the load.
- The display will show adjusted program duration.

Interruption Of A Program

- To pause, press Start/ Pause. The indicator will start flashing.
- Press the Start/Pause again. The program will continue.

Changing A Program

Changing a running program is possible only by switching off the appliance.

- Press the “On/Off” button to cancel the program and to turn off the appliance.
- Press the “On/Off” button again to start the appliance.



Now you can set a new wash program and change any available options. Press Start/Pause to start the new program.

Changing The Options

It may be possible to change some of the options after a wash program has started.

1. Press the touchpad Start/Pause. The indicator will start flashing.
2. If available change the options that you wish.
3. Press Start/Pause again. The program will continue.

Opening The Door



- While a program or the Delay End is operating, the appliance door is locked and the display shows the indicator “  ”. First, set the machine to PAUSE by pressing the “Start/Pause” touchpad. Wait until the door lock indicator goes off, then the door can be opened.
- If the door lock indicator “  ” does not disappear, this means that the machine is already heating and the water level is above the bottom edge of the door or the drum is turning. In this case the door CAN NOT be opened. If you need to open it, you must drain the water to open the door.

In case of emergency please refer to “Emergency door opening” on page 33.

At The End Of The Program

- The appliance stops automatically.
- The acoustic signal will operate.
- The display will show “0:00”.
- The indicator of the touchpad Start/Pause goes off.
- The door lock indicator “ ” goes off.
- Remove the laundry from the appliance. Make sure that the drum is empty.
- Keep the door partly open, to prevent the mildew and odours.
- Turn off the water tap.



When The Washing Program Is Completed, But There Is Water In The Drum

(Option “Rinse Hold  ” or “Extra Silent  ” is used)

- The drum turns regularly to prevent the creases in the laundry.
- The indicator “Start/Pause” flashes to remind you to drain the water.
- The door lock indicator “ ” is on. The door stays locked.

You must drain the water to open the door.

To drain the water:

1. Press the “Start/Pause  ” touchpad. The appliance drains the water and spins with the maximum spin speed for selected program. Alternatively, before pressing the “Start/Pause” touchpad, you can press the “Spin ” touchpad to change the spin speed. You can select “No Spin (---)”, if you want the machine to only drain the water.
2. When the program is completed and the door lock indicator “ ” goes off, you can open the door.
3. Press the “On/Off” button to deactivate the appliance.

AUTO Off Mode

The AUTO Off mode automatically deactivates the appliance to decrease the energy consumption when:

- You do not press any buttons for 5 minutes before you press “Start/Pause”.
 - Press the “On/Off” button to activate the appliance again.
- After 5 minutes from the end of the washing program.
 - Press the “On/Off” button to reactivate the appliance. Display will show the end of the last wash.
 - Press any touchpad again to show the last wash program.

WASHING HINTS

Sorting The Laundry

- Follow the wash code symbols on each garment label and the manufacturer's washing instructions. Sort the laundry as follows: whites, coloureds, synthetics, delicates, woollens.

Temperatures

Temp	Soil level
90°C	For normally soiled white cottons and linen (e.g. teacloths, towels, tablecloths, sheets...).
60°C 50°C	For normally soiled, colourfast garments (e.g. shirts, night dresses, pajamas....) in linen, cotton or synthetic fibres and for lightly soiled white cotton (e.g. underwear).
40°C 30°C Cold	For delicate items (e.g. net curtains), mixed laundry including synthetic fibres and woollens bearing the label pure new wool, machine washable, non-shrink.

Before Loading The Laundry

- Make sure that no metal objects are left in the laundry (e.g. coin, hair clips, safety pins, pins).

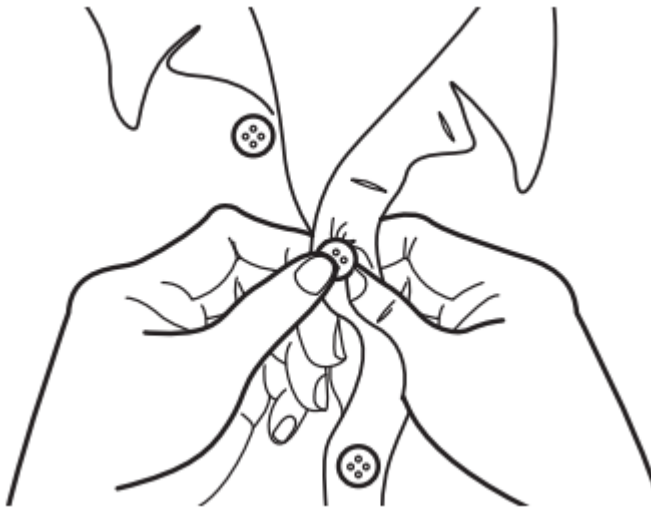



- Button up pillowcases, close zip fasteners, hooks and poppers. Tie any belts or long tapes.

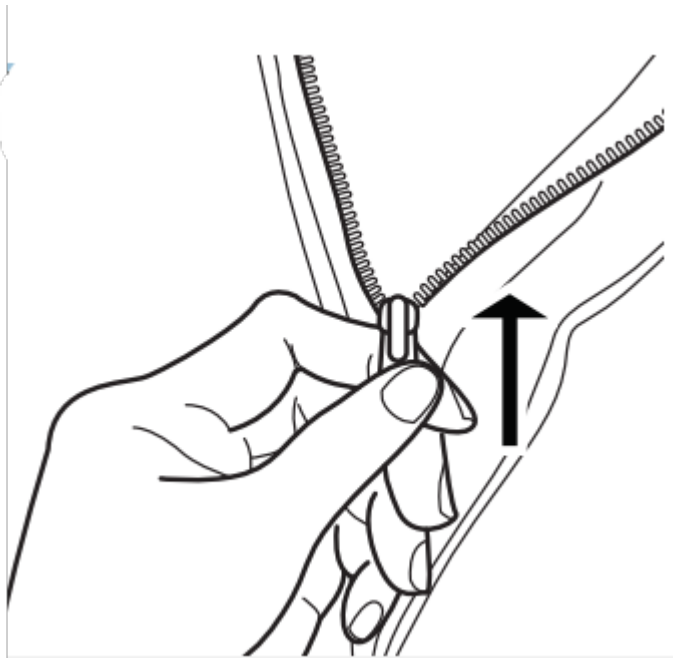

- Wash bras, pantyhose and other delicates in a mesh laundry bag, which you can purchase from your supermarket.

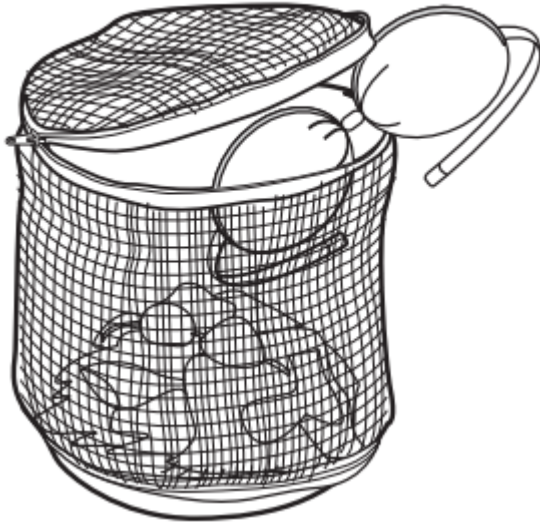

- Make sure that you wash lint collectors separately from lint producers.
- Never wash whites and coloured fabrics together. Whites may lose their “whiteness” in the wash.
- New coloured items may run in the first wash; they should therefore be washed separately the first time. Button up pillowcases, close zip fasteners, hooks and poppers. Tie any belts or long tapes.
- Remove persistent stains before washing.
- Rub particularly soiled areas with a special detergent or detergent paste. Treat curtains with special care. Remove hooks or tie them up in a bag or a net.

Maximum Loads

Recommended loads are indicated in the program charts on page 11.

General rules:

Clothes Load	Quantity
Cotton, linen	drum full but not too tightly packed;
Synthetics	drum no more than half full;
Delicate fabrics and woollens	drum no more than one third full.

Washing a maximum load makes the most efficient use of water and energy. For heavily soiled laundry, reduce the load size.

Removing Stains

- Stubborn stains may not be removed by just water and detergent. It is therefore advisable to treat them prior to washing.
- Blood: treat fresh stains with cold water. For dried stains, soak overnight in water with a special detergent then rub in the soap and water
- Oil based paint: moisten with benzine stain remover, lay the garment on a soft cloth and dab the stain; treat several times.
- Dried grease stains: moisten with turpentine, lay the garment on a soft surface and dab the stain with the fingertips and a cotton cloth.
- Rust: oxalic acid dissolved in hot water or a rust removing product used in cold water. Be careful with rust stains which are not recent since the cellulose structure will already have been damaged and the fabric tends to hole.
- Mould stains: treat with bleach, rinse well (whites and fast coloureds only).
- Grass: soap lightly and treat with bleach (whites and fast coloureds only). Ball point pen and glue: moisten with acetone (*), lay the garment on a soft cloth and dab the stain.
- Lipstick: moisten with acetone (*) as above, then treat stains with methylated spirits. Remove any residual marks from white fabrics with bleach. Red wine: soak in water and detergent, rinse and treat with acetic or citric acid, then rinse. Treat any residual marks with bleach.
- Ink: depending on the type of ink, moisten the fabric first with acetone (*), then with acetic acid; treat any residual marks on white fabrics with bleach and then rinse thoroughly.
- Tar stains: first treat with stain remover, methylated spirits or benzine, then rub with detergent paste.

(*) do not use acetone on artificial silk.

Detergents Type And Quantity Of Detergent

- Low sudsing detergent is required for this washing machine to prevent oversudsing problems, unsatisfactory washing result and harm to the machine
- Low sudsing detergents designed for front load washing machines are labelled “Front Loading”, “high efficiency”, “HE”, such as Cold Power for Front Loaders or “Matic”.
- Do not use wrong types of detergent, such as Top Loading, Handwash detergent or Soap-Based products in your frontload washing machine. This can result in excessive suds, longer cycle time, low spin speeds, poor rinsing and overloading of the motor.

Quantity of detergent to be used

The choice of detergent and use of correct quantities not only affects your wash performance, but also helps to avoid waste and protect the environment. Although biodegradable detergents contain substances which in large quantities can upset the delicate balance of nature.

The choice and quantity of detergent will depend on ;

- type of fabric (delicates, woollens, cottons, etc.) ;
- the colour of clothes ;
- size of the load ;
- degree of soil ;
- wash temperature ; and
- hardness of the water used.

Water hardness is classified by so-called “degrees” of hardness.

Information on hardness of the water in your area can be obtained from the relevant water supply company, or from your local authority

You may have to try using the detergent quantity as per manufacturers’ instructions then compare the wash result to the list below and adjust the amount of detergent for your future washes accordingly.

Not enough detergent causes:

- the washload to turn grey,
- greasy clothes.

Too much detergent causes:

- oversudsing
- reduced washing effect,
- inadequate rinsing.

Use less detergent if:

- you are washing a small load,
- the laundry is lightly soiled,
- large amounts of foam during washing.

CARE AND CLEANING

WARNING! You must **DISCONNECT** the appliance from the electricity supply, before you can carry out any cleaning or maintenance work.

External Cleaning

- Clean the appliance only with soap and warm water. Fully dry all the surfaces.

CAUTION! Do not use alcohol, solvents or chemical products.

Descaling

- The water we use normally contains lime. It is a good idea to periodically use a water softening powder in the machine.
- Do this separately from any laundry washing, and according to the softening powder manufacturer's instructions
- This will help to prevent the formation of lime deposits.

After Each Wash

- Leave the door open for a while. This helps to prevent mould and stagnant smells forming inside the appliance.
- Keeping the door open after a wash will also help to preserve the door seal.

Maintenance Wash With “Tub Clean” Program

- With the use of low temperature washes it is possible to get a build up of residues inside the
- We recommend to use “Tub Clean” program to clean the drum regularly to remove any residue.

To run a maintenance wash:

- The drum should be empty of laundry
- Select the “Tub Clean” program
- Press Start/Pause to start the program.

Cleaning The Dispenser Drawer

- The washing powder and additive dispenser drawer should be cleaned regularly.
- Remove the drawer by pressing the catch downwards and by pulling it out.

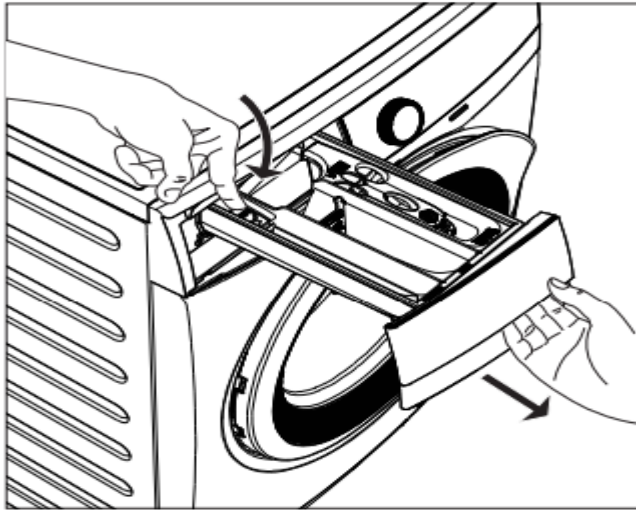

- To aid cleaning, the top part of the additive compartment should be removed.

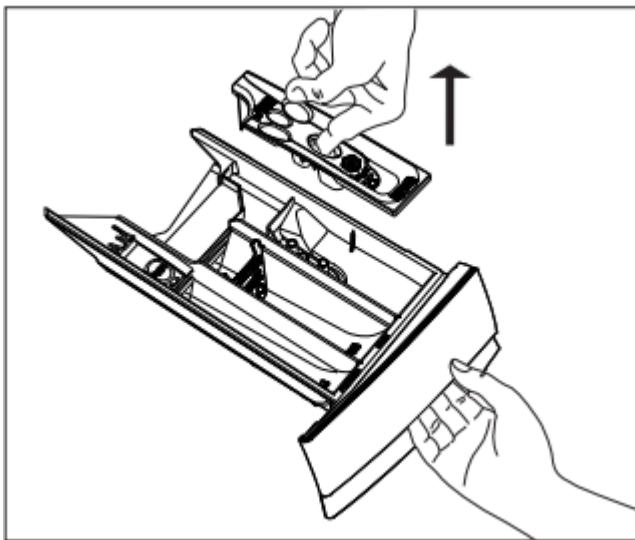

- Flush it out under a tap to remove any traces of accumulated powder.

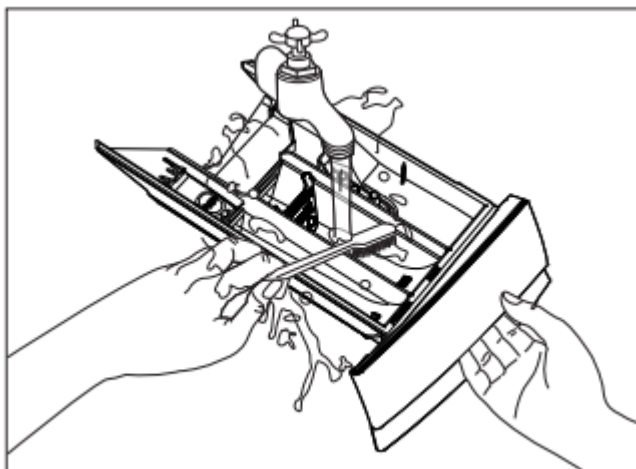

Cleaning The Drawer Recess

- Having removed the drawer, use a small brush to clean the recess, ensuring that all washing powder residue is removed from the upper and lower part of the recess. Replace the drawer and run the rinse program without any clothes in the drum.

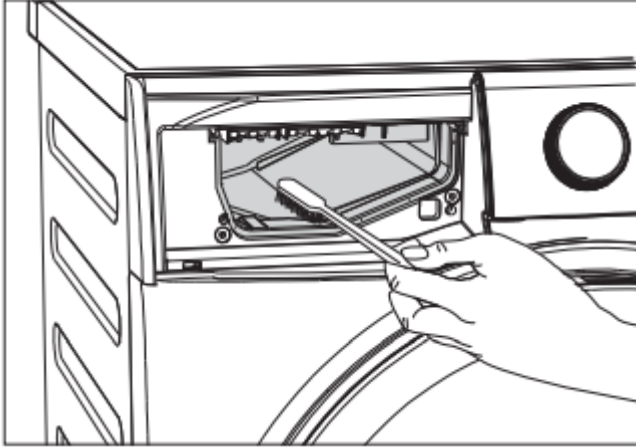

Cleaning The Pump

Regularly examine the drain pump and make sure that it is clean.

Clean the pump if:

- The appliance does not drain the water.
- The drum cannot turn.
- The appliance makes an unusual noise because of the blockage of the drain pump.
- The display shows an alarm code because of the problem with water drain.

WARNING!

1. Disconnect the mains plug from the mains socket.
2. Do not remove the filter while the appliance is operating. Do not clean the drain pump if the water in the appliance is hot. The water must be cold before you clean the drain pump.

To clean the drain pump:

1. Open the drain pump door.

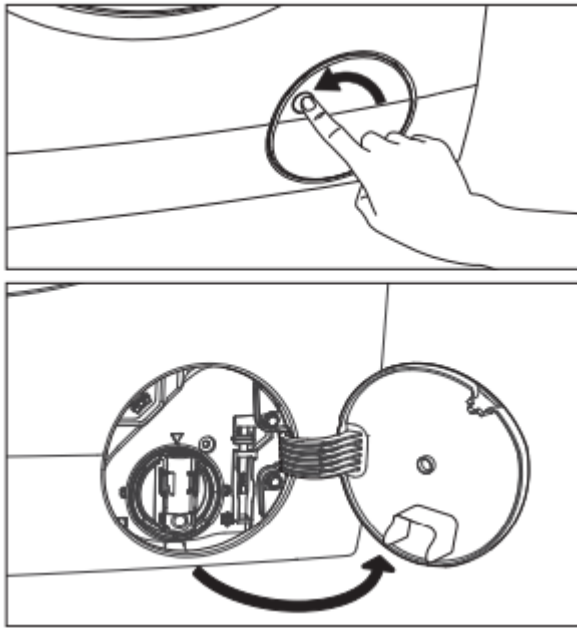

2. Place a suitable water container below the recess of the drain pump to collect the water that flows out.

Press the two levers and pull forward the drainage duct to let the water flow out.

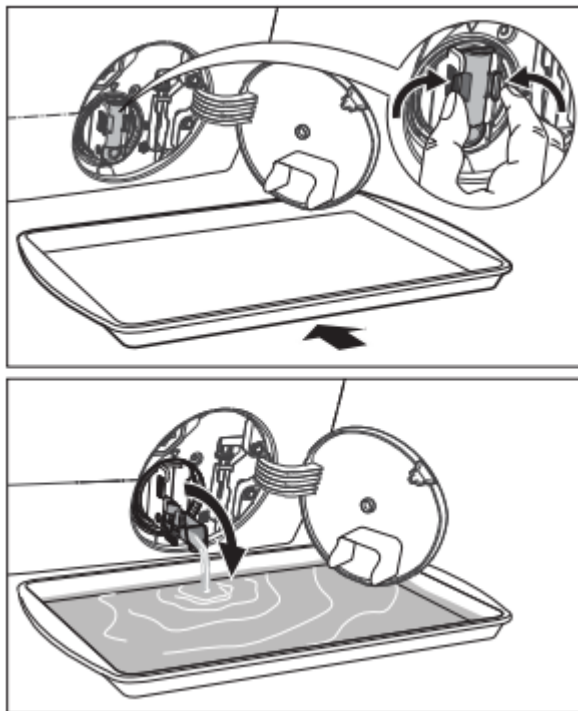

3. When the container is full of water, put the drainage duct back again and empty the container. Do step 2, 3 again and again until no more water flows out from the drain pump.

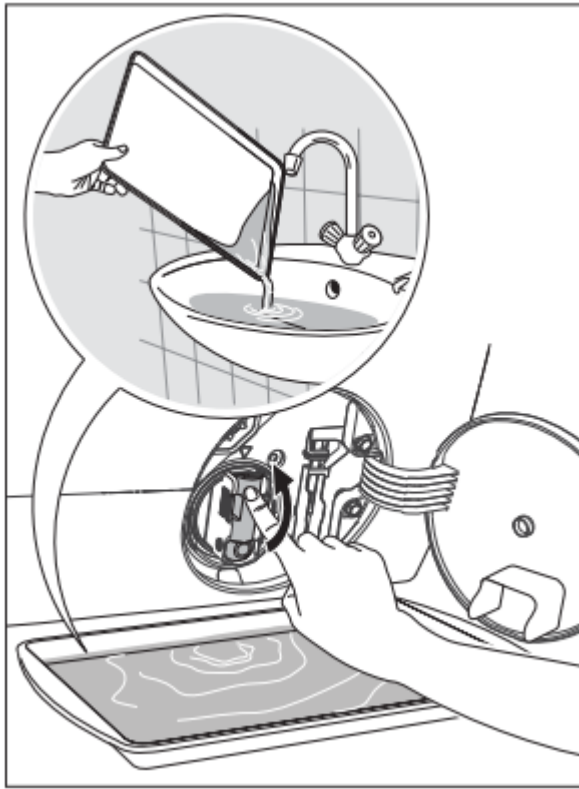

4. Push back the drainage duct and turn the filter counter-clockwise to remove it.

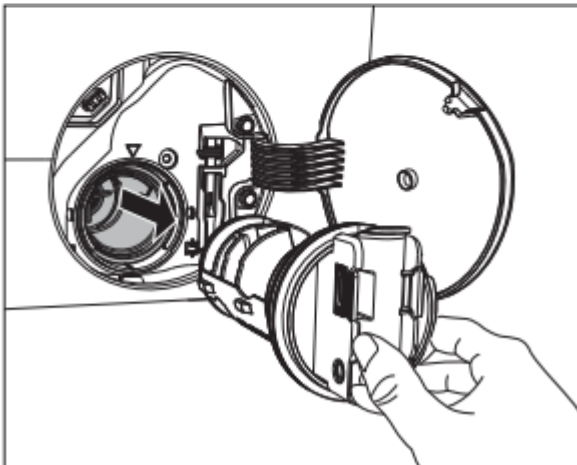
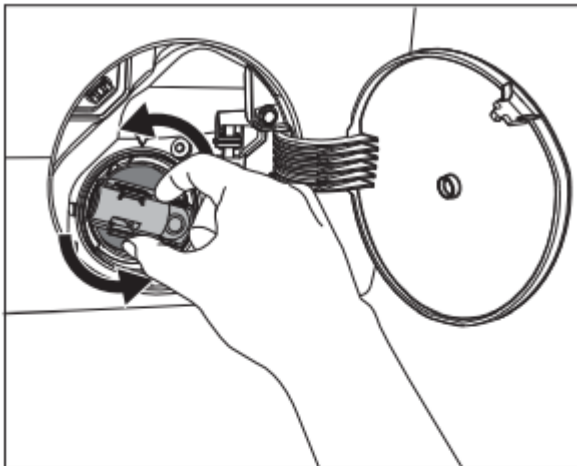

5. Remove fluff and objects from the pump (if there are any).

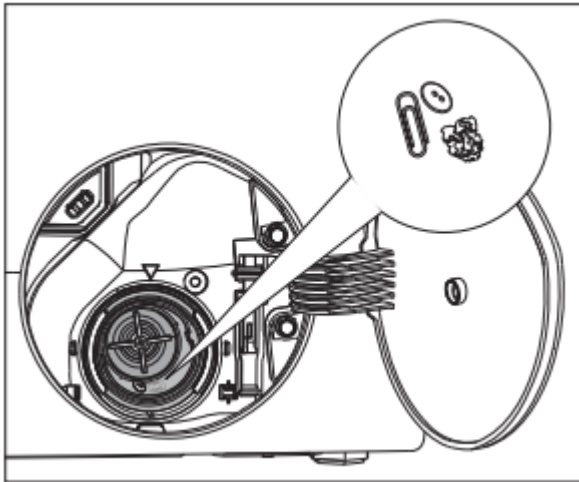

6. Make sure that the impeller of the pump can turn. If this does not occur, contact the service centre.

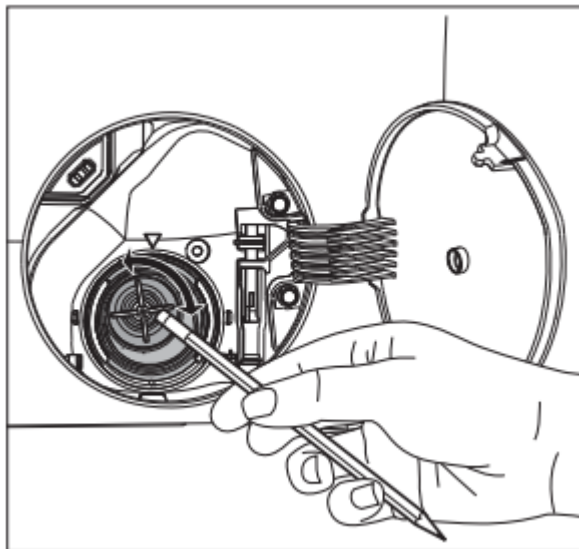

7. Clean the filter under the water tap.

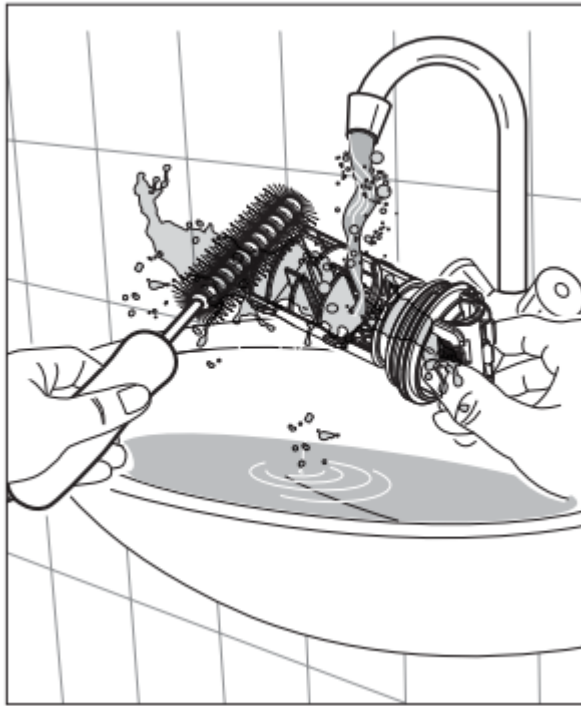

8. Put the filter back into the housing with exposed section facing up. Make sure that you correctly tighten the filter to prevent leakages.

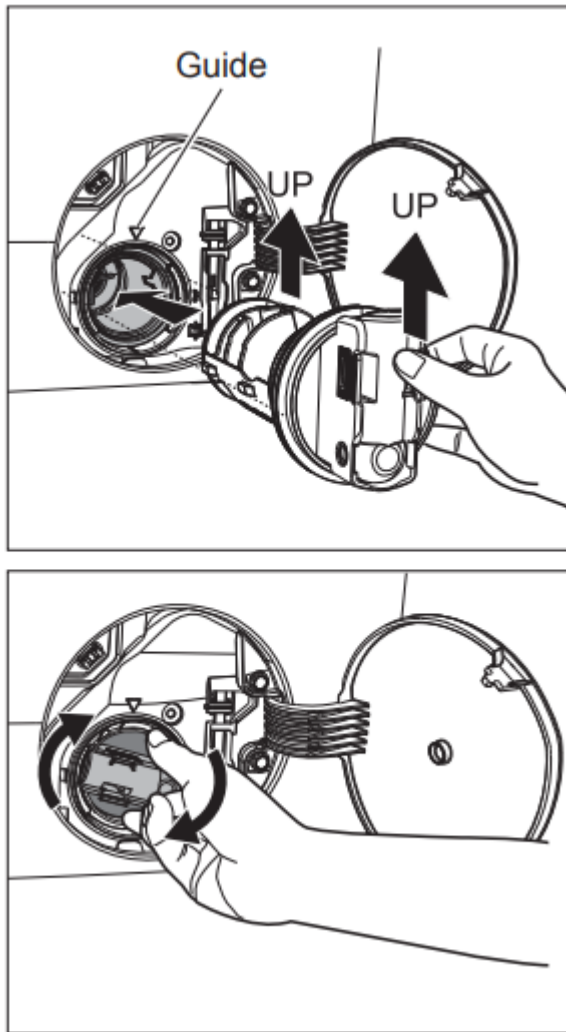

9. Close the drain pump door.

Cleaning The Water Inlet Filter

If your water is very hard or contains traces of lime deposit, the water inlet filter may become clogged. It is therefore a good idea to clean it from time to time.

To clean the water inlet filters:

1. Close the water tap
2. Remove the water inlet hose from the water tap.
3. Clean the filter in the inlet hose with a stiff brush.

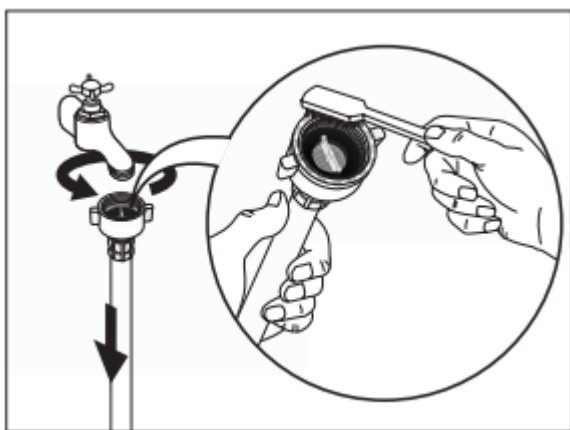

4. Remove the inlet hose behind the appliance.

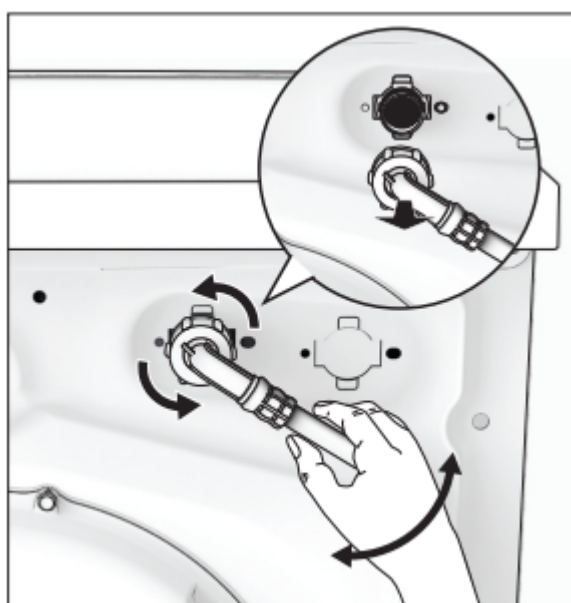

5. Clean the filter in the valve with a stiff brush or a towel.

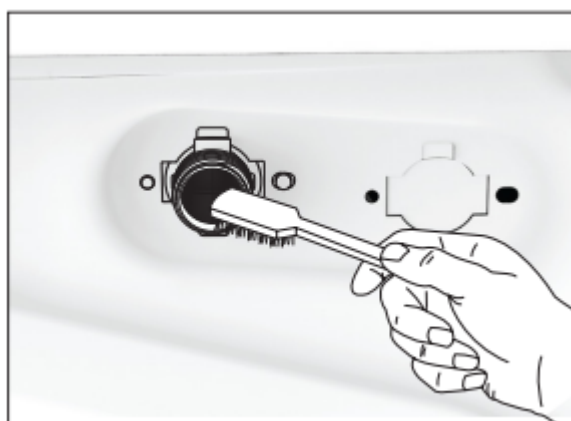

6. Install the inlet hose again. Make sure that the couplings are tight to prevent leakages.

7. Open the water tap.

Frost Precautions

If the appliance is installed in an area where the temperature can be less than 0 °C, remove the remaining water from the inlet hose and the drain pump.

Emergency Drain

1. Disconnect the main plug from the main socket. Turn off the water tap.
2. Remove the water inlet hose.
3. Remove the drain hose from the rear support and unhook it from sink or spigot.

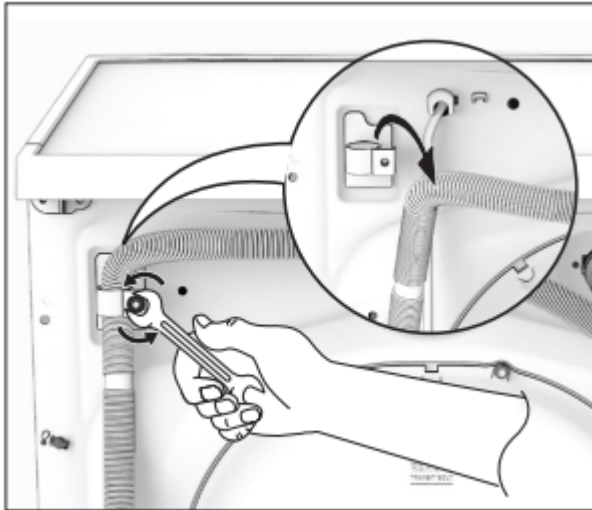

4. Put the end of the drain and inlet hose in a container. Let the water flow out of the hoses.

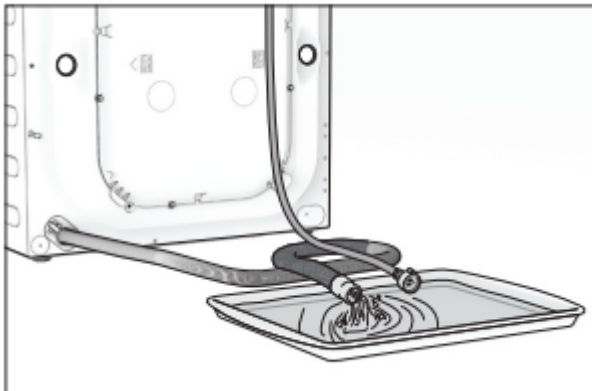

5. When no more water flows, install the inlet hose and the drain hose again.

NOTE: Make sure that the temperature is more than 0 °C before you use the appliance again.

TROUBLESHOOTING





Possible Failures

Certain problems are due to lack of simple maintenance or oversights, which can be solved easily without calling out an engineer. Before contacting your local Service Centre, please check troubleshooting.

Once the problem has been eliminated, press the Start/Pause button to restart the program. If after all checks, the problem persists, contact your local Service Centre.

WARNING! Deactivate the appliance before you do the checks.

Alarm Code:

	The appliance does not fill with water properly.
	The appliance does not drain the water.
	The appliance door is open or not closed correctly. Please check the door!
	The main supply is unstable. Wait until the main supply is stable.
	No communication between electronic elements of the appliance. Switch off and switch on again.

Malfunction	Possible cause	Solution
Machine does not start:	The door has not been closed. (Error code: E40)	Close the door firmly.
	The plug is not properly inserted into the power socket.	Insert the plug into the power socket.
	There is no power at the socket.	Please check your domestic electrical installation.
	The Start/Pause touchpad has not been pressed.	Press the Start/Pause touchpad.
	The “Delay End” has been selected.	If the laundry are to be washed immediately, cancel the “Delay End”.
	The Main supply is unstable. (If E40 appears on the display.)	Wait until the main supply is stable. Appliance will start automatically.
Machine does not fill the water:	The water tap is closed. (Error code: E 10)	Open the water tap.
	The inlet hose is squashed or kinked. (Error code: E 10)	Check the inlet hose connection.
	The filter in the inlet hose is blocked. (Error code: E 10)	Clean the water inlet hose filter.
	The door is not properly closed. (Error code: E40)	Close the door firmly.
Machine fills then empties immediately:	The end of the drain hose is too low. (Error code: E 10)	Refer to relevant paragraph in “water drainage” section.
Machine does not empty and/or does not spin:	The drain hose is squashed or kinked. (Error code: E20)	Check the drain hose connection.

	The drain pump is clogged. (Error code: E20)	Clean the drain filter.
	The option “Extra Silent” or “Rinse Hold” has been selected.	Press Start/Pause touchpad to drain the water or select spin program.
	The laundry is not evenly distributed in the drum.	Pause the machine and redistribute laundry manually.
There is water on the floor:	Too much detergent or unsuitable detergent (creates too much foam) has been used.	Reduce detergent quantity and use correct type of detergent (refer page 23).
	Check whether there are any leaks from one of the inlet hose fittings. It is not always easy to see this as the water runs down the hose; check to see if it is damp.	Check the water inlet hose connection.
	The drain hose is damaged.	Call Service.
Unsatisfactory washing results:	Too little detergent or unsuitable detergent has been used.	Increase detergent quantity or use different detergent (refer page 23).
	Stubborn stains have not been treated prior to washing.	Use commercial products to treat the stubborn stains.
	The correct temperature was not selected.	Check if you have selected the correct temperature.
	Excessive laundry load.	Reduce load.
The door will not open:	The program is still running.	Wait until the end of cycle.
	There is water in the drum.	You must drain the water to open the door (refer “Opening The Door” on page 20).



	This problem may be caused by a failure of the appliance.	Contact Service. If you need to open the door, please read carefully “Emergency door opening” on page 33.
Machine vibrates or is noisy:	The transit bolts and packing have not been removed.	Check the correct installation of the appliance.
	The support feet have not been adjusted.	Check the correct levelling of the appliance.
Machine vibrates or is noisy:	The laundry is not evenly distributed in the drum.	Pause the machine and redistribute laundry manually.
	There is very little laundry in the drum.	Load more laundry.
	Unstable floors eg. wooden floors.	Refer to relevant paragraph in “Positioning” section.
Cycle time longer than displayed:	Detergent over dose.	Reduce the detergent quantity or use another one. (Refer page 23 “Detergents Type And Quantity Of Detergent”).
	Machine unbalance.	Redistribute laundry manually in the drum and start the spin phase again.
The cycle is shorter than the time displayed.	The appliance calculated a new time according to the laundry a load.	
Spinning starts late or machine does not spin:	The electronic unbalance detection device has cut in because the laundry is not evenly distributed in the drum. The laundry is redistributed by reverse rotation of the drum.	Pause the machine and redistribute laundry manually.



This may happen several times before the unbalance disappears and normal spinning can resume. If, after 10 minutes, the laundry is still not evenly distributed in the drum, the machine will not spin. In this case, redistribute the load manually and select the spin program.

Machine makes an unusual noise:	Machine not installed properly.	Make sure the levelling of the appliance is correct. Refer to "Installation".
	Transit bolts or packaging not removed.	Make sure that the packaging and/or the transit bolts are removed. Refer to "Unpacking".
	The load may be too small.	Add more laundry in the drum.
No water is visible in the drum:	Machines based on modern technology operate very economically using very little water without affecting performance.	

If you are unable to identify or solve the problem, contact our service centre.

Before calling service centre, make a note of the model, serial number and purchase date of your machine: the Service Centre will require this information.



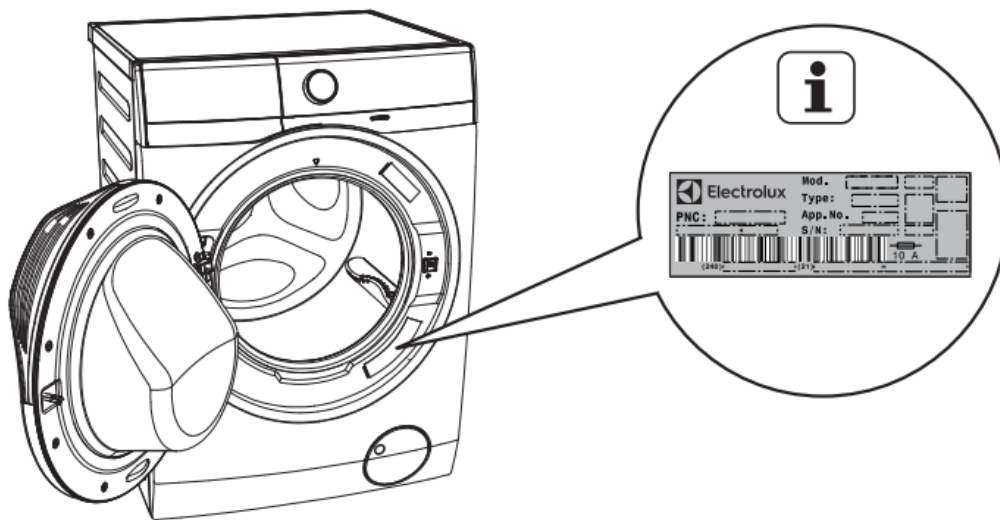

Emergency Door Opening

In case of power failure or appliance failure, the appliance door remains locked. The wash program continues when power is restored. If the door remains locked in case of failure, it is possible to open it using the emergency unlock feature.

Before opening the door:

WARNING! Make sure that the water temperature and the laundry are not hot. Wait until they cool down if necessary. Make sure that the water level inside the drum is not too high. If necessary, perform an Emergency Drain (see page 29). Make sure that the drum is not rotating. Wait until the drum stops rotating if necessary.

To open the door proceed as follows:

1. Press the On/Off button to switch the appliance off.
2. Disconnect the mains plug from the mains socket.
3. Open the filter cover.
4. Without touching the door, insert a small flathead screw driver into the slot on emergency unlock strap (red strap) and pull down twice then pull the door open. Repeat if unsuccessful.

Note: Do not pull down emergency strap too hard.

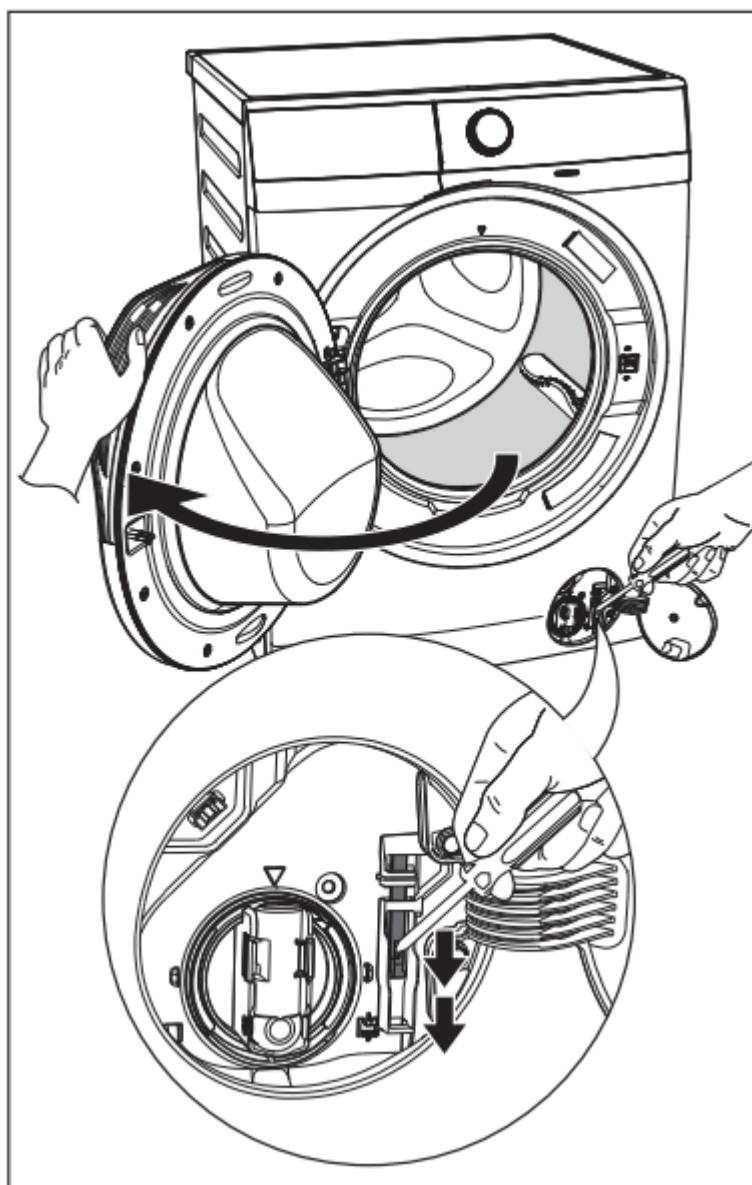

5. Take out the laundry.

6. Close the filter flap.

If you are unable to identify or solve the problem, contact our service centre.

Before calling service centre, make a note of the model, serial number and purchase date of your machine: the Service Centre will require this information.

Warning

This content is compiled from multiple sources and is provided for reference purposes only. It may not be complete or fully applicable to all situations. If you are unable to resolve your issue, please contact the product manufacturer or an authorized service provider for official support.

