

REFRIGERATOR USE

Power On/Off Switch

If you need to turn the power to your refrigerator On or Off, you must remove the top grille assembly to access the power switch. Turn the power to the refrigerator Off before plugging/unplugging unit, or when cleaning your refrigerator.

To Remove Top Grille:

1. Grasp both ends of the top grille.
2. Push the top grille straight up, then pull straight out. Lay the grille on a soft surface.

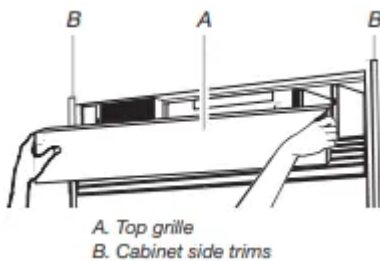

To Replace Top Grille:

1. Insert top grille hooks (located on the back of the top grille) onto mounting bolts on the side trim.
2. Pull grille down slightly to lock into place.

Turn Power On or Off:

1. Remove top grille.
2. Press power switch to the ON or OFF position.
3. Replace top grille.

IMPORTANT: Make sure the power switch is set to the ON position after cleaning refrigerator or changing light bulbs.

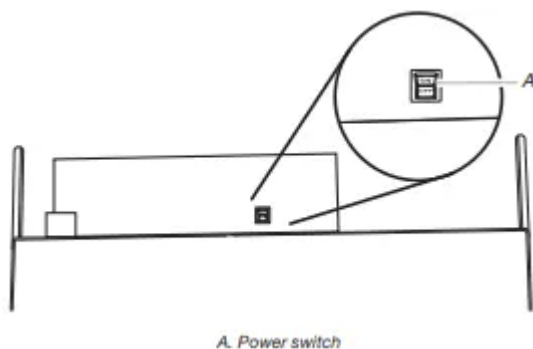

Using the Controls

IMPORTANT:

- The refrigerator control adjusts the refrigerator compartment temperature. The freezer control adjusts the freezer compartment temperature.
- Wait 24 hours after you turn on the refrigerator before you put food into it. If you add food before the refrigerator has cooled completely, your food may spoil. NOTE: Adjusting the refrigerator and freezer controls to a lower (colder) setting will not cool the compartments any faster.
- If the temperature is too warm or too cold in the refrigerator or freezer, first check the air vents to be sure they are not blocked before adjusting the controls.
- The present settings should be correct for normal household usage. The controls are set correctly when milk or juice is as cold as you like and when ice cream is firm.
- The actual temperature may differ from the display when a door is open for an extended period of time.

NOTE: The factory recommended set points are 0°F (-18°C) for the freezer and 37°F (3°C) for the refrigerator.

Turning Refrigerator On and Viewing Set Points



- Press the Cooling (ON/OFF) touch pad.

NOTE:

- After the refrigerator is turned on, the Over Temperature audio alarm and indicator light may activate every 1 1/2 hours until the refrigerator and freezer temperatures are below 48°F (9°C) and 15°F (-9°C), respectively, or until the alarm is turned off. To turn off the audio alarm and indicator light, see "Master Alarm Reset."
- The Cooling ON/OFF touch pad on the control panel shuts down refrigerator functions such as cooling, lighting, fans and compressors. To turn the power off completely, use the power ON/OFF switch located behind the top grille. See "Power On/ Off Switch."

Viewing the Celsius Temperatures

- Press the F/C touch pad. To redisplay degrees Fahrenheit, press F/C again.



NOTE: If the freezer temperature is below zero, the negative sign next to the freezer display will light up. This is normal.

Adjusting Controls

NOTE: Wait at least 24 hours between adjustments. Recheck the temperatures before other adjustments are made.

To Adjust Set Point Temperatures:

- Press the refrigerator or freezer PLUS (+) or MINUS (-) touch pad until the desired temperature is reached.

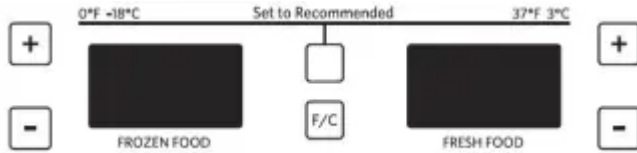

- Press the Set To Recommended touch pad to reset the set points to the factory recommended temperatures. NOTE: The set point range for the freezer is -5°F to 3°F (-21°C to -16°C). The set point range for the refrigerator is 34°F to 42°F (1°C to 6°C).

CONDITION /REASON::	TEMPERATURE ADJUSTMENT:
REFRIGERATOR too cold Not set correctly for conditions	REFRIGERATOR Control 1° higher
REFRIGERATOR too warm High use or room very warm	REFRIGERATOR Control 1° lower
FREEZER too cold Not set correctly for conditions	FREEZER Control 1° higher
FREEZER too warm/too little ice High use or heavy ice use	FREEZER Control 1° lower

Water Filter Indicator and Reset

See “Water Filter Indicator” section.

Max Cool

The Max Cool feature assists with periods of heavy ice usage, full grocery loads, or temporarily warm room temperatures.

- Press MAX COOL to turn on the Max Cool feature. The Max Cool indicator light will remain on for 24 hours unless manually turned off.



NOTE: The temperature display will remain at 34°F (1°C) and -5°F (-21°C) for the refrigerator and freezer compartments, respectively, while the Max Cool feature is enabled. After 24 hours, the refrigerator returns to the previous temperature set points

Alarm Functions

Master Alarm Reset

Pressing Alarm Reset once will turn off the audio alarm and indicator light. The audio alarm will not sound again for the current condition that caused the alarm until a new condition occurs or until a Master Alarm Reset is performed.

A Master Alarm Reset can be performed by pressing Cooling (ON/ OFF) twice or by turning the power to the refrigerator off and on again. See “Power On/Off Switch.” After performing a Master Alarm Reset, the indicator light will reactivate if the condition that caused the alarm is still present. See “Over Temperature,” “Call Service,” or “Door Open.”



Door Open

The Door Open indicator light will flash, an alarm will sound and the interior lights will turn off when a door has been open for longer than 10 minutes. When the door is closed, the audio alarm will reset and turn off, but the Door Open indicator light will continue to flash until the temperature is equal to or below 45°F (7°C) and 15°F (-9°C) for the refrigerator and freezer compartments, respectively

NOTE: To deactivate the audio alarm and indicator light, see “Master Alarm Reset.”

Over Temperature

IMPORTANT: If the Over Temperature Alarm activates, your food may spoil. See the “Power Interruptions.” Minimize door openings until temperatures return to normal.

The Over Temperature feature is designed to let you know when either the refrigerator temperature rises above 48°F (9°C) or the freezer temperature rises above 15°F (-9°C) for longer than 1^{1/2} hours. The audio alarm will shut off automatically when the temperature returns to normal, but the indicator light will continue to flash until the Alarm is pressed to let you know that an over temperature condition has occurred.

If the over temperature condition is still present when an Over Temperature Reset is performed, the indicator light will continue to reactivate every 1^{1/2} hours until refrigerator and freezer temperatures are below 48°F (9°C) and 15°F (-9°C), respectively.

NOTE: The audio alarm will be disabled for subsequent occurrences of over temperature alarm condition. To enable the audio alarm, see “Master Alarm Reset.”

Sabbath Mode

The Sabbath Mode feature is designed for the traveler or for those whose religious observances require turning off the lights and ice maker. By selecting this feature, the temperature set points and Deli Pan settings remain unchanged, the ice maker will be disabled and the interior lights will turn off. For most efficient refrigerator operation, it is recommended to exit the Sabbath Mode when it is no longer required.

To fully activate Sabbath Mode, you must follow the instructions below for both the control panel and dispenser panel (on some models).

IMPORTANT: If you do not activate Sabbath Mode in both ways listed below, some functions you wish to disable will remain active

Control Panel

In Sabbath Mode, the temperature set points remain unchanged and the interior lights turn off.

- Press SABBATH MODE to turn on Sabbath Mode.



- Press SABBATH MODE again to turn off Sabbath Mode.

Dispenser Panel Holiday Mode (on some models)

In Holiday Mode, the dispenser levers are disabled and the dispenser lights turn off.

- To turn on Holiday Mode, press and hold ICE, LIGHT and LOCKOUT at the same time for 3 seconds. When the feature turns on, the indicator light around the LOCKOUT button will blink and "HOL" will appear on the dispenser display.
- To turn Holiday Mode off, press and hold ICE, LIGHT and LOCKOUT at the same time for 3 seconds again.

NOTE: If the Max Cool feature has been selected prior to turning on the Holiday Mode feature, then the set points will remain at 34°F (1°C) and -5°F (-21°C) for the refrigerator and freezer compartments, respectively, until the Max Cool feature times out. The refrigerator will then return to the previous temperature set points chosen prior to the selection of the Max Cool feature, but the lights and ice maker will remain off until the Holiday Mode is pressed again.

Water and Ice Dispensers (on some models)

IMPORTANT:

- After connecting the refrigerator to a water source or replacing the water filter, flush the water system. Use a sturdy container to depress and hold the water dispenser lever for 5 seconds, then release it for 5 seconds. Repeat until water begins to flow. Once water begins to flow, continue depressing and releasing the dispenser lever (5 seconds on, 5 seconds off) until a total of 3 gal. (12 L) has been dispensed. This will flush air from the filter and water dispensing system, and prepare the water filter for use. Additional flushing may be required in some households. **NOTE:** As air is cleared from the system, water may spurt out of the dispenser.
- Allow 24 hours for the refrigerator to cool down and chill water.
- Allow 24 hours to produce the first batch of ice. Discard the first three batches of ice produced.

- The dispensing system will not operate when the freezer door is open.
- Depending on your model, your water and ice dispensers may have one or more of the following features: A dispenser tray, a special light that turns on when you use the dispenser, or a lock option to avoid unintentional dispensing.

Water Dispenser

To Dispense Water:

1. Press a sturdy glass against the water dispenser pad.



NOTES:

- While dispensing water and for 3 seconds after dispensing has stopped, the digital display will show how many ounces of water have been dispensed.
- To switch from ounces to cups, press and hold ICE and LOCK at the same time until the dispenser beeps after 3 seconds. To switch from cups to liters, press and hold the buttons for another 3 seconds. To switch back to ounces, repeat the process a third time.

2. Remove the glass to stop dispensing.

NOTE: Water may have an off-flavor if you do not use the dispenser periodically. Dispense enough water every week to maintain a fresh supply

Ice Dispenser

Ice dispenses from the ice maker storage bin in the freezer when the dispenser pad is pressed. The dispensing system will not operate when the freezer door is open. To turn off the ice maker, see “Ice Maker and Storage Bin.”

Your ice maker can produce both crushed and cubed ice. The display screen reads “CRUSHED” or “CUBED,” indicating which type is selected. To change the setting, press the ICE button before dispensing ice.

For crushed ice, cubes are crushed before being dispensed. This may cause a slight delay when dispensing crushed ice. Noise from the ice crusher is normal, and pieces of ice may vary in size. When changing from crushed to cubed, a few ounces of crushed ice will be dispensed along with the first cubes.

To Dispense Ice:

1. Press the button to select the desired type of ice.
2. Press a sturdy glass against the ice dispenser pad. Hold the glass close to the dispenser opening so ice does not fall outside of the glass.



IMPORTANT: You do not need to apply a lot of pressure to the pad in order to activate the ice dispenser. Pressing hard will not make the ice dispense faster or in greater quantities.

3. Remove the glass to stop dispensing.

NOTE: Ice may continue to dispense for up to 10 seconds after removing the glass from the pad. The dispenser may continue to make noise for a few seconds after dispensing.

Dispenser Tray (on some models)

Some models have a tray at the bottom of the dispenser area. The tray is designed to catch small spills and is removable for easy emptying and cleaning.

NOTE: There is no drain in the tray

Dispenser Light (on some models)

When you use the dispenser, the light will automatically turn on. If you want the light to be on continuously, you may choose either ON or AUTO.

ON: Press LIGHT to turn the dispenser light on.

AUTO: Press LIGHT a second time to select AUTO mode. The dispenser light will automatically adjust to become brighter as the room brightens and dimmer as the room darkens.

OFF: Press LIGHT a third time to turn the dispenser light off.

The dispenser lights are LEDs that cannot be changed. If it appears that your dispenser lights are not working, make sure that the light sensor is not blocked (in AUTO mode). See “Troubleshooting” for more information.

Ice Maker and Storage Bin (on some models - Accessory)

IMPORTANT: Flush the water system before turning on the ice maker. See “Water and Ice Dispensers.” Allow 24 hours to produce the first batch of ice. Discard the first three batches of ice produced. Allow 3 days to completely fill the ice container.

Style 1

To Turn the Ice Maker On/Off:

The On/Off switch for the ice maker is a wire shutoff arm located on the side of the ice maker.

1. To turn the ice maker ON, simply lower the wire shutoff arm. **NOTE:** Your ice maker has an automatic shutoff. As ice is made, the ice cubes will fill the ice storage bin and the ice cubes will raise the wire shutoff arm to the OFF (arm up) position.

2. To manually turn the ice maker off, lift the wire shutoff arm to the OFF (arm up) position and listen for the click to make sure the ice maker will not continue to operate.

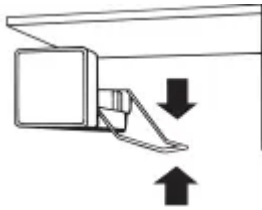

To Remove and Replace the Ice Bin:

1. Flip up the covering panel.

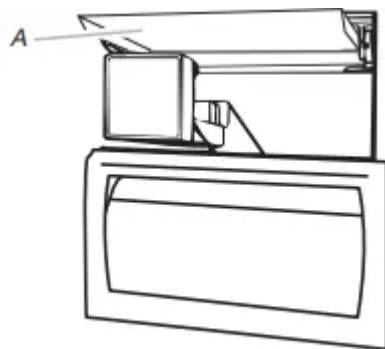

A. Ice maker cover

2. Lift the wire shutoff arm so it clicks into the OFF (up) position. Ice can still be dispensed, but no more can be made.
3. Lift up the front of the storage bin and pull the ice bin forward.
4. Replace the bin by pushing it in all the way or the dispenser will not work. Push the wire shutoff arm down to the ON position to restart ice production. Make sure the door is closed tightly.

Style 2

To Turn the Ice Maker On/Off:

The On/Off switch is located on the top right side of the freezer compartment.

1. To turn the ice maker on, slide the control to the ON (left) position. NOTE: Your ice maker has an automatic shutoff. The ice maker sensors will automatically stop ice production, but the control will remain in the ON (left) position.
2. To manually turn the ice maker off, slide the control to the OFF (right) position.

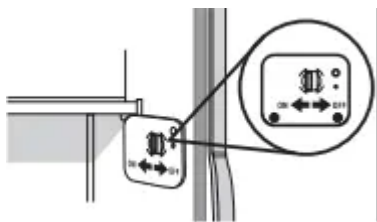

To Remove and Replace the Ice Storage Bin:

1. Hold the base of the storage bin with both hands and press the release button to lift the storage bin up and out. NOTE: It is not necessary to turn the ice maker control to the OFF (right) position when removing the storage bin. The sensor cover (“flipper door”) on the left wall of the freezer stops the ice maker from producing ice if the door is open or the storage bin is removed.
2. Replace the storage bin on the door and push down to make sure it is securely in place.



Clean the Ice Storage Bin

NOTE: It is normal for ice to stick together in the ice bin. Ice may be dispensed or used more frequently which will break up the ice. It is recommended that the ice container be emptied and cleaned as needed.

To clean the ice storage bin:

1. Empty the ice container. Use warm water to melt the ice if necessary. NOTE: Do not use anything sharp to break up the ice in the bin or bucket. This can cause damage to the ice container and the dispenser mechanism.
2. Wash ice bin with a mild detergent, rinse well and dry thoroughly. Do not use harsh or abrasive cleaners or solvents.

Water Filtration System

Changing the Water Filter

The water filter is located in the base grille below the freezer compartment door. It is not necessary to remove the base grille to remove the filter.

1. Remove the filter by pressing the eject button and pulling straight out on the filter cap.

NOTES:

- Avoid twisting the cap when removing the filter because this could cause the cap to come off. If this occurs, replace the cap and pull the filter straight out.
- There will be water in the filter. Some spilling may occur.

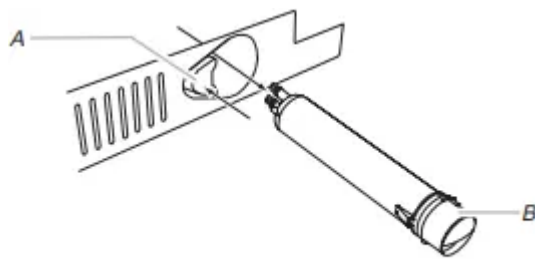

A. Eject button
B. Filter cap

2. Remove the cap by turning it counterclockwise until it stops. **IMPORTANT:** Do not discard the cap. It is part of your refrigerator. Keep the cap to use with the replacement filter.

3. Align the ridge on the cap with the arrow on the new filter, and turn the cap until it snaps into place.

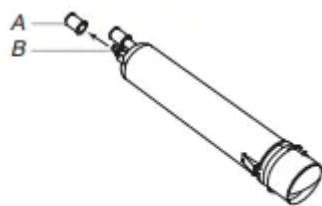

A. Cover
B. O-rings

4. Remove the covers from the O-rings. Make sure that O-rings are still in place after the covers are removed.

5. Place the cap (removed in Step 2) on the new filter. Align the ridge on the cap with the arrow on the filter. Turn the cap clockwise until it snaps into place.

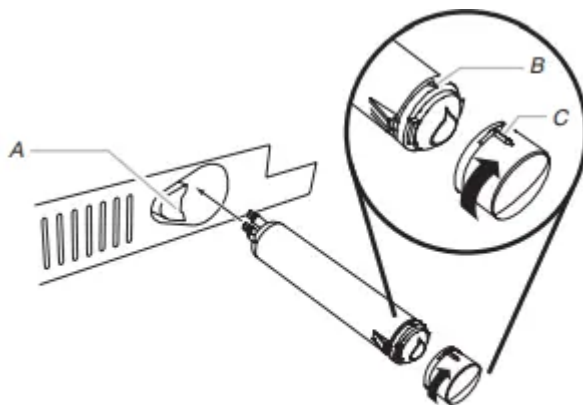

A. Eject button
B. Arrow on filter
C. Ridge on cap

6. Push the new filter into the opening in the base grille. As the filter is inserted, the eject button will depress. The eject button will pop back out when the filter is fully engaged.

7. Pull gently on the cap to check that the filter is securely in place.

8. Flush the water system. Depending on your model, see “Water and Ice Dispensers” or “Ice Maker and Storage Bin.”

Using the Ice Maker Without a Water Filter

You can operate the ice maker without a water filter. Your ice will not be filtered.

1. Remove the filter by pressing the eject button and pulling on the cap. See “Changing the Water Filter” earlier in this section.
2. Remove the cap by turning it counterclockwise until it stops. **IMPORTANT:** Do not discard the cap. It is part of your refrigerator.
3. With the cap in a horizontal position, insert the cap into the base grille until it stops.

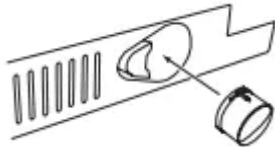

4. Turn the cap counterclockwise until the cap slips into the attachment slot. Then, turn the cap clockwise until it is in a horizontal position. **NOTE:** The cap will not be even with the base grille.

REFRIGERATOR FEATURES

Refrigerator Shelves

The shelves in your refrigerator are adjustable to meet your individual storage needs.

Storing similar food items together in your refrigerator and adjusting the shelves to fit different heights of items will make finding the exact item you want easier. It will also reduce the amount of time the refrigerator door is open and help save energy.

Shelves and Shelf Frames

To remove and replace a shelf/frame:

1. Remove the shelf/frame by tilting it up at the front and lifting it out of the shelf supports. Pull shelf straight out.
2. Replace the shelf/frame by guiding the rear shelf hooks into the shelf supports. Tilt the front of the shelf up until the rear shelf hooks drop into the shelf supports.
3. Lower the front of the shelf and check that the shelf is in position.

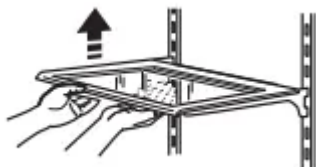

Ingredient Care Center

The control for the Ingredient Care Center adjusts the storage temperature of the pan. Cold air flows into the pan through the air duct between the freezer and the refrigerator. Setting the controls allows more or less cold air through the air duct.

To Adjust the Ingredient Care Center

1. Choose a setting based on the item to be stored in the pan.
2. Push the button that corresponds to that setting.
3. The indicator light for that setting will illuminate to verify that the pan is ready to be loaded.



Remove and Replace the Ingredient Care Center Cover

1. Remove food from Ingredient Care Center cover. Pull drawer out about 4" (10.16 cm). Reach under the glass shelf with both hands and lift gently upward until back of shelf is free. Tilt the shelf at an angle and remove the shelf from the refrigerator. Be sure not to bump the glass.

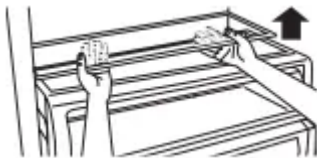

2. Replace the cover by holding the glass shelf firmly with both hands, tilt the shelf at an angle and position it above the support rails. Place shelf gently on support rails on side wall.

FREEZER FEATURES

Freezer Shelf

To remove and replace the shelf:

1. Remove the shelf by lifting it up and pulling it straight out.
2. Replace the shelf by putting it over the supports and lowering it into place.



Freezer Basket

The freezer basket can be used to store bags of frozen fruits and vegetables that may slide off freezer shelves.

To remove and replace the freezer basket:

1. Pull the basket straight out to the stop.
2. Lift the front of the basket and slide it out the rest of the way

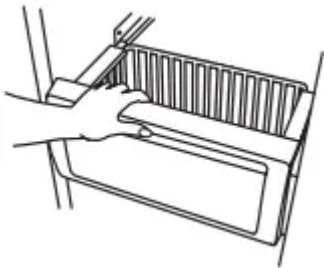

3. Replace the basket by positioning it on the side wall guide rails. Lift the basket front slightly while pushing it past the guide rail stops and slide basket in the rest of the way

DOOR FEATURES

Utility Compartment (on some models)

The utility compartment can be placed in any position on the refrigerator door.

To remove and replace the utility bin:

1. Remove utility compartment by grasping both ends and lifting compartment up and out.
2. Replace the bin by sliding it in above the desired support and pushing it down until it stops.

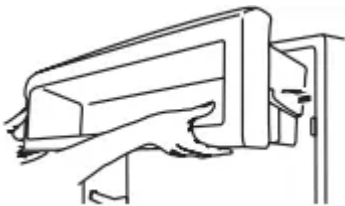

Door Bins

Large door bins hold gallon containers and the smaller door bins hold 2-liter bottles. The door bins are adjustable and removable for easy cleaning and adjusting.

Gallon Door Bin

To install the gallon door bin:

NOTE: The gallon door bin can only be placed on the lower door support.

1. Position gallon door bin above lowest door adjustment slot.
2. Push down to secure bin.
3. Adjust other bins, as necessary to allow for milk or beverage container height.

Door Bins

To remove and replace the door bins:

1. Remove the bin by lifting it up and pulling it out.
2. Replace the bin by sliding it in above the desired support and pushing it down until it stops.



REFRIGERATOR CARE

Cleaning

Both the refrigerator and freezer sections defrost automatically. However, clean both sections about once a month to avoid buildup of odors. Wipe up spills immediately.

To Clean Your Refrigerator:

1. Remove the top grille. See "Power On/Off Switch."
2. Press the power switch to OFF.
3. Remove all removable parts from inside, such as shelves, crispers, etc.
4. Hand wash, rinse, and dry removable parts and interior surfaces thoroughly. Use a clean sponge or soft cloth and a mild detergent in warm water.
 - Do not use abrasive or harsh cleaners such as window sprays, scouring cleansers, flammable fluids, cleaning waxes, concentrated detergents, bleaches or cleansers

containing petroleum products on plastic parts, interior and door liners or gaskets. Do not use paper towels, scouring pads, or other harsh cleaning tools. These can scratch or damage materials.

- To help remove odors, you can wash interior walls with a mixture of warm water and baking soda (2 tbs to 1 qt [26 g to 0.95 L] of water).

5. Wash stainless steel and painted metal exteriors with a clean sponge or soft cloth and a mild detergent in warm water. Do not use abrasive or harsh cleaners, or cleaners containing chlorine. Dry thoroughly with a soft cloth.

- NOTE: To keep your Stainless Steel refrigerator looking like new and to remove minor scuffs or marks, it is suggested that you use the manufacturer's approved Stainless Steel Cleaner and Polish.
- IMPORTANT: This cleaner is for stainless steel parts only!

Do not allow the Stainless Steel Cleaner and Polish to come into contact with any plastic parts such as the trim pieces, dispenser covers or door gaskets. If unintentional contact does occur, clean plastic part with a sponge and mild detergent in warm water. Dry thoroughly with a soft cloth. To order the cleaner, see "Accessories."

6. Press the power switch to ON.

7. Replace the top grille. See "Power On/Off Switch."

Lights

The lights in both the refrigerator and freezer compartments are LEDs which do not need to be replaced. If the lights do not illuminate when the door or drawer is opened, call for assistance or service. In the U.S.A., call 1-800-422-1230. In Canada call 1-800-807-6777.

Power Interruptions

If the power will be out for 24 hours or less, keep the door or doors closed (depending on your model) to help food stay cold and frozen.

If the power will be out for more than 24 hours, do one of the following:

- Remove all frozen food and store it in a frozen food locker.
- Place 2 lbs (907 g) of dry ice in the freezer for every cubic foot (28 L) of freezer space. This will keep the food frozen for 2 to 4 days.
- If neither a food locker nor dry ice is available, consume or can perishable food at once.

REMEMBER: A full freezer stays cold longer than a partially filled one. A freezer full of meat stays cold longer than a freezer full of baked goods. If you see that food contains ice crystals, it may be refrozen, although the quality and flavor may be affected. If the condition of the food is poor, dispose of it.

Vacation Care

Your refrigerator is equipped with the Sabbath Mode feature, which is designed for the traveler or for those whose religious observances require turning off the lights and ice maker. By selecting this feature, the temperature set points remain unchanged, the ice maker will be disabled and the interior lights will turn off. For most efficient refrigerator operation, it is recommended to exit Sabbath mode when it is no longer required.

If You Choose to Leave the Refrigerator On While You're Away:

1. Use up any perishables and freeze other items.
2. Press the SABBATH touch pad.
3. If your refrigerator has an automatic ice maker, shut off the water supply to the ice maker.
4. Empty the ice bin.
5. When you return from vacation, press the SABBATH touch pad to return to normal operation.

If You Choose to Turn Off the Refrigerator Before You Leave:

1. Remove all food from the refrigerator.
2. If your refrigerator has an automatic ice maker:
 - Turn off the water supply to the ice maker at least one day ahead of time.
 - When the last load of ice drops, raise the wire shutoff arm to the OFF (up) position.
3. Under the Fridge or Freezer menu, press and hold COOLING OFF for 3 seconds to turn off cooling. NOTE: To turn off the power completely, use the power ON/ OFF switch located behind the top grille. See "Power On/Off Switch."
4. Clean refrigerator, wipe it, and dry well.
5. Tape rubber or wood blocks to the tops of both doors to prop them open far enough for air to get in. This stops odor and mold from building up.

TROUBLESHOOTING

Refrigerator Operation

The refrigerator will not operate

- Power cord unplugged? Plug into a grounded 3 prong outlet.
- Is outlet working? Plug in a lamp to see if the outlet is working.
- Household fuse blown or circuit breaker tripped? Replace the fuse or reset the circuit breaker. If the problem continues, call an electrician.
- Are controls on? Make sure the refrigerator controls are on. See "Using the Control(s)."

- New installation? Allow 24 hours following installation for the refrigerator to cool completely.
- NOTE: Adjusting the temperature controls to coldest setting will not cool either compartment more quickly.

The motor seems to run too much

Your new refrigerator may run longer than your old one due to its high-efficiency compressor and fans. The unit may run even longer if the room is warm, a large food load is added, doors are opened often, or if the doors have been left open.

The refrigerator seems noisy

Refrigerator noise has been reduced over the years. Due to this reduction, you may hear intermittent noises from your new refrigerator that you did not notice from your old model. Below are listed some normal sounds with explanations.

- Buzzing - heard when the water valve opens to fill the ice maker.
- Pulsating - fans/compressor adjusting to optimize performance.
- Rattling - flow of refrigerant, movement of water lines, or from items placed on top of the refrigerator.
- Sizzling/Gurgling - water dripping on the heater during defrost cycle.
- Popping - contraction/expansion of inside walls, especially during initial cool-down.
- Water running - may be heard when ice melts during the defrost cycle and water runs into the drain pan.
- Creaking/Cracking - occurs as ice is being ejected from the ice maker mold.

There is no audible door open alarm

Has the door been open less than 10 minutes? The door open alarm will only flash when the door has been open for 10 minutes. The audible alarm will sound the first time the door is left open for more than 10 minutes. Subsequent door open alarms will only flash. You must reset the audible alarm each time. See “Using the Control(s).”

The doors will not close completely

- Door blocked open? Move food packages away from door.
- Bin or shelf in the way? Push bin or shelf back in the correct position.

The doors are difficult to open

- Are the gaskets dirty or sticky? Clean gaskets and contact surfaces with mild soap and warm water. Rinse and dry with soft cloth.

The lights do not work

- Is the refrigerator in Sabbath mode? See “Using the Controls.”

- Has the door been open more than 10 minutes? See “Using the Controls.”

Temperature and Moisture

Temperature is too warm

- New installation? Allow 24 hours following installation for the refrigerator to cool completely.
- Door(s) opened often or left open? Allows warm air to enter refrigerator. Minimize door openings and keep doors fully closed.
- Large load of food added? Allow several hours for refrigerator to return to normal temperature.
- Controls set correctly for the surrounding conditions? Adjust the controls a setting colder. Check temperature in 24 hours. See “Using the Control(s).”
- Refrigerator not cooling? For models with digital controls, turn the refrigerator OFF and then ON to reset. If this does not correct the problem, call for service.
- Air vents blocked? Remove any item from in front of the air vents.

There is interior moisture buildup

NOTE: Some moisture buildup is normal.

- Humid room? Contributes to moisture buildup.
- Door(s) opened often or left open? Allows humid air to enter refrigerator. Minimize door openings and keep doors fully closed.

Ice and Water

The ice maker is not producing ice or not enough ice

- Refrigerator connected to a water supply and the supply shutoff valve turned on? Connect refrigerator to water supply and turn water shutoff valve fully open.
- Kink in the water source line? A kink in the line can reduce water flow. Straighten the water source line.
- Ice maker turned on? Make sure wire shutoff arm or switch (depending on model) is in the ON position.
- New installation? Wait 24 hours after ice maker installation for ice production to begin. Wait 72 hours for full ice production.
- Freezer door closed completely? Firmly close the freezer compartment door. If the freezer compartment door will not close all the way, see “The doors will not close completely,” earlier in this section.
- Large amount of ice recently removed? Allow 24 hours for ice maker to produce more ice.

- Ice cube jammed in the ice maker ejector arm? Remove ice from the ejector arm with a plastic utensil.
- Water filter installed on the refrigerator? Remove filter and operate ice maker. If ice volume improves, then the filter may be clogged or incorrectly installed. Replace filter or reinstall it correctly.
- Reverse osmosis water filtration system connected to your cold water supply? This can decrease water pressure. See “Water Supply Requirements.”

The ice cubes are hollow or small

NOTE: This is an indication of low water pressure.

- Water shutoff valve not fully open? Turn the water shutoff valve fully open.
- Kink in the water source line? A kink in the line can reduce water flow. Straighten the water source line.
- Water filter installed on the refrigerator? Remove filter and operate ice maker. If ice quality improves, then the filter may be clogged or incorrectly installed. Replace filter or reinstall it correctly.
- Reverse osmosis water filtration system connected to your cold water supply? This can decrease water pressure. See “Water Supply Requirements.”
- Questions remain regarding water pressure? Call a licensed, qualified plumber.

Ice is sticking together in the ice storage bin

- It is normal for frost to be on top of the ice storage bin due to normal opening and closing of the freezer.
- It is normal for ice to stick together when it is not dispensed or used frequently. It is recommended that the ice storage bin be emptied and cleaned as needed. See “Ice Maker and Storage Bin.”

Off-taste, odor or gray color in the ice

- New plumbing connections? New plumbing connections can cause discolored or off-flavored ice.
- Ice stored too long? Discard ice. Wash ice bin. Allow 24 hours for ice maker to make new ice.
- Odor transfer from food? Use airtight, moisture proof packaging to store food.
- Are there minerals (such as sulfur) in the water? A water filter may need to be installed to remove the minerals.
- Is there a water filter installed on the refrigerator? Gray or dark discoloration in ice indicates that the water filtration system needs additional flushing.

The ice dispenser will not operate properly

- Freezer door closed completely? Close the door firmly. If it does not close completely, see “The doors will not close completely.”
- Ice bin installed correctly? Be sure the ice bin is firmly in position.
- New installation? Wait 24 hours after ice maker installation for ice production to begin. Wait 72 hours for full ice production.
- Ice stuck in the delivery chute? Use a plastic utensil to clear the delivery chute.
- Has the wrong ice been added to the bin? Use only cubes produced by the current ice maker.
- Has the ice melted around the auger (metal spiral) in the ice bin? Empty the ice container. Use warm water to melt the ice if necessary
- Is the ice dispenser stalling while dispensing “crushed” ice? Change the ice button from “crushed” to “cubed.” If cubed ice dispenses correctly, depress the button for “crushed” ice and begin dispensing again.
- Has the dispenser arm been held in too long? Ice will stop dispensing when the arm is held in too long. Wait 3 minutes for dispenser motor to reset before using again.

The water dispenser will not operate properly

- Freezer door closed completely? Close the door firmly. If it does not close completely, see “The doors will not close completely.”
- Refrigerator connected to a water supply and the supply shutoff valve turned on? Connect refrigerator to water supply and turn water shutoff valve fully open.
- Is the water pressure at least 30 psi (207 kPa)? The water pressure to the home determines the flow from the dispenser. See “Water Supply Requirements.”
- Kink in the home water source line? Straighten the water source line.
- New installation? Flush and fill the water system.
- Water filter installed on the refrigerator? The filter may be clogged or incorrectly installed.
- Is a reverse osmosis water filtration system connected to your cold water supply? See “Water Supply Requirements” in either the Installation Instructions or the Use & Care Guide.

Water is leaking from the dispenser

NOTE: One or two drops of water after dispensing is normal.

- Glass not being held under the dispenser long enough? Hold the glass under the dispenser 2 to 3 seconds after releasing the dispenser lever.
- New installation? Flush the water system. See “Prepare the Water System” or “Water and Ice Dispensers.”

- Recently changed water filter? Flush the water system. See “Prepare the Water System” or “Water and Ice Dispensers.”

The dispenser water is not cool enough

NOTE: Water from the dispenser is chilled to only 50°F (10°C).

- New installation? Allow 24 hours after installation for the water supply to cool completely.
- Recently dispensed large amount of water? Allow 24 hours for water supply to cool completely.
- Water not been recently dispensed? The first glass of water may not be cool. Discard the first glass of water.
- Refrigerator connected to a cold water pipe? Make sure the refrigerator is connected to a cold water pipe. See “Water Supply Requirements.”

Warning

This content is compiled from multiple sources and is provided for reference purposes only. It may not be complete or fully applicable to all situations. If you are unable to resolve your issue, please contact the product manufacturer or an authorized service provider for official support.