

## VACUUM ASSEMBLY

### CARTON CONTENTS

- A. Handle\*
- B. Vacuum Base
- C. Wand
- D. Crevice Tool
- E. Turbo Tool
- F. Adjustable Dusting Brush\*
- G. (1) Large Screw
- H. Dirt Cup

\*Varies per model.

Remove all parts from carton and identify each item shown.

Make sure all parts are located before disposing of packing materials.

### ATTACH HANDLE

1.2 Insert handle section into vacuum base. Push down firmly. Using a Phillips screwdriver, fasten (1) large screw behind handle into vacuum base.

1.3 Wrap hose around top of hose guide located on the handle. Insert the hose into hose tube until you hear a click.

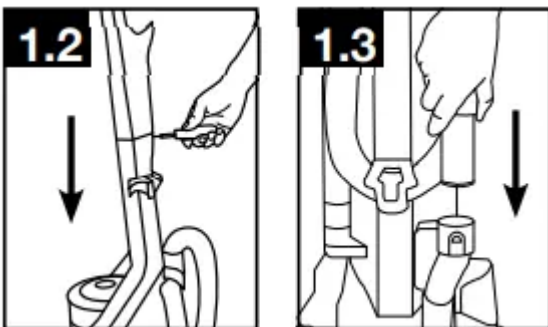

### POSITION TOOLS

1.4 Place Crevice Tool into Wand and slide into tool storage area on left back side (C) of vacuum and place Turbo Tool on right back side (E) of vacuum as shown.

1.5 Place adjustable dusting brush (F) on top of wand.

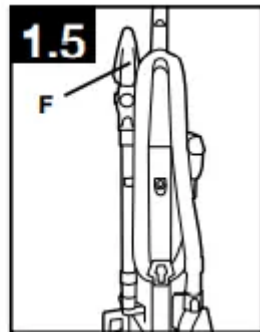
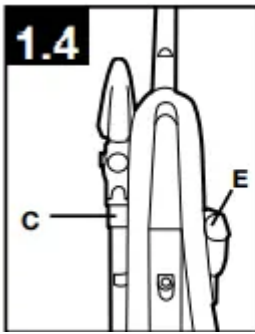

## ATTACH DIRT CUP

1.6 Place bottom of dirt cup into vacuum body first. Pivot cup into vacuum. Dirt cup is secure when you hear a click.

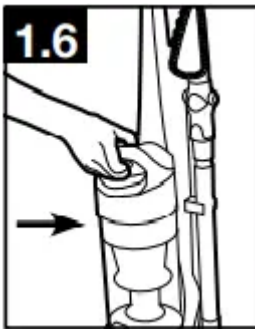

## HOW TO USE

### VACUUM DESCRIPTION

1. Handle
2. Dirt Cup Release Button
3. Carry Handle
4. System Check Indicator
5. Rinsable Filter Access
6. Dirt Cup
7. Filter made with HEPA media
8. Height Adjustment
9. Furniture Guard
10. Adjustable Dusting Brush
11. Wand
12. Crevice Tool (inside wand)
13. Cord Rewind Pedal
14. Brushroll ON/OFF Pedal

- 15. Handle Release Pedal
- 16. Hose
- 17. Turbo Tool
- 18. ON/OFF Switch
- 19. Hose Release Button
- 20. Hose Connecting Tube

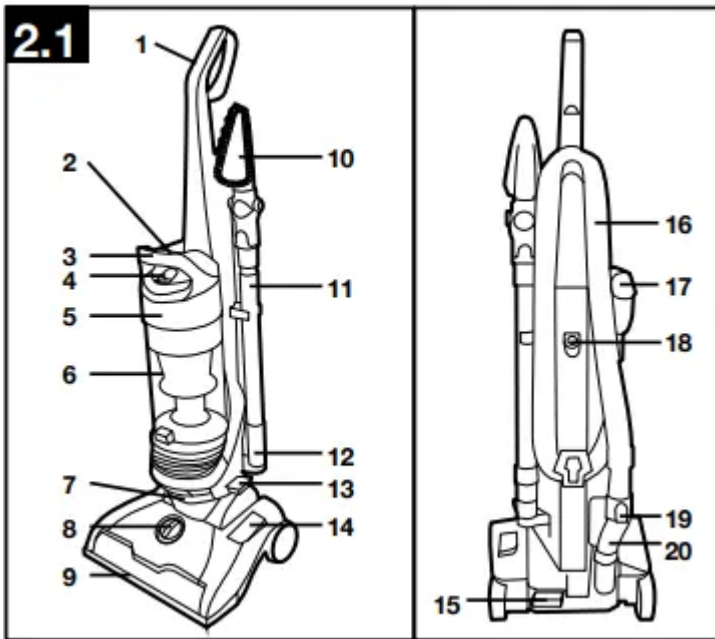

## ON-OFF SWITCH

2.2 Plug cord into electrical outlet.

To turn vacuum ON (I=ON), push ON/OFF switch (A) to ON position.

To turn vacuum OFF (O=OFF), push switch to OFF position.

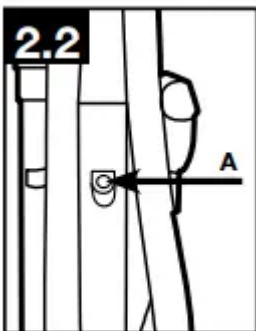

## CORD RELEASE

2.3 Prior to using, grasp the end of the plug and pull to release the cord from the cord reel until red tape is reached.

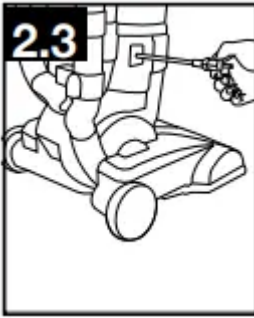

### CARPET HEIGHT ADJUSTMENT\*

2.4 To adjust height setting, PUSH DOWN and TURN knob (C) to desired height setting.

For maximum cleaning performance, the following carpet height settings are recommended:

- Hard floor setting: for use on hard floors only.
- Low through High settings: Adjust depending on carpet type.
- For high pile carpet, use high carpet setting to ease pushing effort.

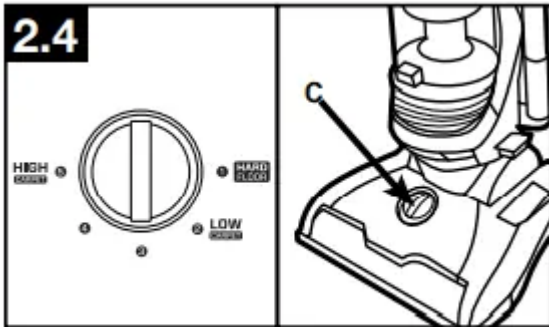

\*Number of height settings vary per model.

### SUCTION ONLY MODE/ BRUSHROLL SHUT-OFF for bare floors and very high pile carpet

2.3 For optimal cleaning performance on bare floors and carpet with pile deeper than 1", brushroll should be turned off.

The vacuum is shipped with the brushroll in the ON position. To turn brushroll OFF for Suction Only Mode, step on pedal (A).

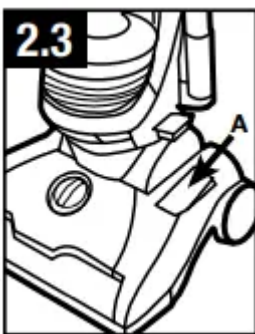

## TOOLS

Tools allow for cleaning surfaces above the floor and for reaching hard to clean areas. The vacuum is ready for tool use when handle is in upright position.

### SELECT PROPER TOOL

A. Wand is used to give extra length to your hose. Use it with any of the above tools.

B. Crevice Tool may be used in tight spaces, corners and along edges in such places as dresser drawers, upholstered furniture, stairs and baseboards.

C. Turbo Tool may be used for upholstered furniture, draperies, mattresses, clothing, and carpeted stairs.

D. Use Adjustable Dusting Brush to clean upholstered furniture, draperies, mattresses, clothing, carpeted stairs, light fixtures, and fans with 5 cleaning positions.

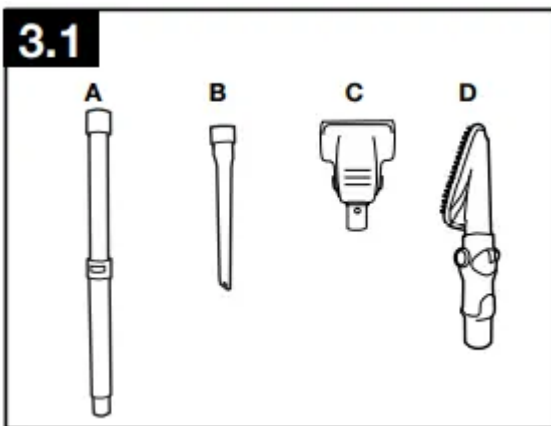

### REMOVING HOSE

3.2 To remove hose for tool use, press the hose release button and pull hose end out. To lock back into place, push hose into hose tube until you hear a click.

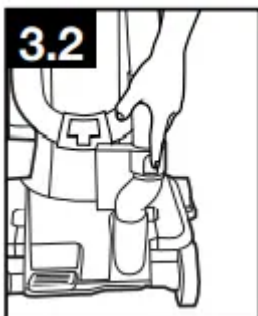

### ATTACH WAND AND TOOLS

3.3 To attach tool or wand to hose, push firmly into place.

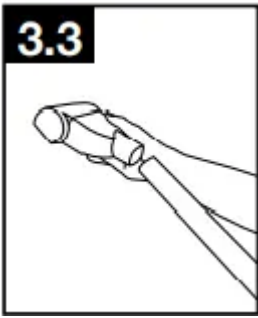

### STAIR CLEANING

3.4 Use the Hose and Turbo Tool (Tool varies per model) for stair cleaning

CAUTION Use extra care when cleaning on stairs. To avoid personal injury or damage, and to prevent the cleaner from falling, always place cleaner at bottom of stairs on floor. Do not place cleaner on stairs or furniture, as it may result in injury or damage. When using tools, always ensure handle is in the upright position.

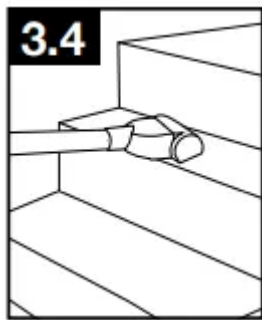

### CORD REWIND AND STORAGE

3.5 To return cord for storage, hold plug and press down Cord Release Pedal (B) on side of cord reel.

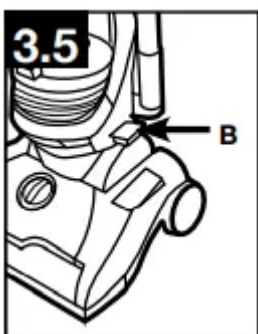

### HOW TO CLEAN TOOLS

To clean Hose and Turbo Tool, wipe with a damp cloth. DO NOT submerge in water. Other cleaning tools may be washed in warm water with a detergent. Rinse and air dry 24 hours before using.

## MAINTENANCE

Familiarize yourself with these home maintenance tasks as proper use and care of your vacuum will ensure continued cleaning effectiveness.

4.1 The System Check Indicator located at (A), alerts you to possible system performance issues.

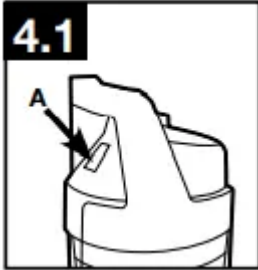

### If System Check Indicator is red:

- Rinsable filter and/or filter made with HEPA media is dirty.
  - Clean rinsable filter and/or filter made with HEPA media
- Dirt cup is full and/or clogged.
  - Empty dirt cup
- Cyclone filter assembly is clogged.
  - Clean cyclone filter assembly

Any other servicing should be done by an authorized service representative. If appliance is not working as it should, has been dropped, damaged, left outdoors, or dropped into water, take it to a service center prior to continuing use.

### DIRT CUP: When to Empty

4.2 To maintain optimal performance, empty the dirt cup before the dirt cup reaches the max line (B). Place the vacuum in the upright position before removing the dirt cup.

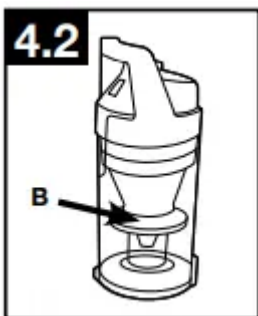

### How to Empty

4.3 Press dirt cup release button (C) and pivot cup out.

4.4 Hold dirt cup over trash receptacle, push dirt cup door release lever (D) to open dirt cup door (E). Close dirt cup door (E). Press firmly to secure.

4.5 Place bottom of dirt cup into vacuum body first. Pivot dirt cup into vacuum body and press firmly until it locks into place.

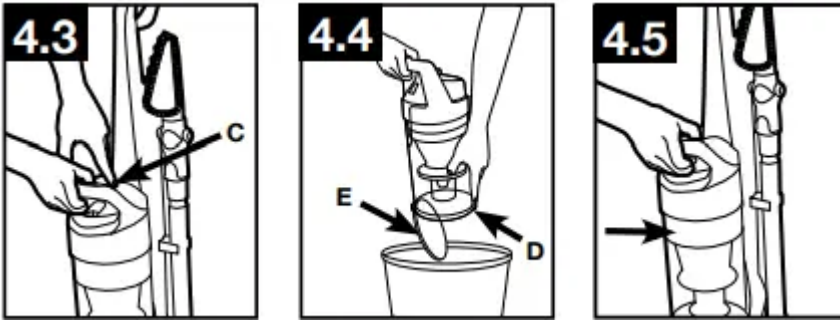

#### **FILTERS: When to Clean**

To maintain optimal performance, filters should be cleaned at least every two months under normal use.

#### **Rinsable Filter: How to Clean**

Remove dirt cup as described in Fig. 4.3.

4.6 Twist the dirt cup handle counterclockwise to open and remove lid.

4.7 Pull tab to remove rinsable filter.

Rinse with water for two minutes or until water runs clear. Then squeeze out excess water. Allow 24 hours for filter to dry completely.

Replace filter, tab side out.

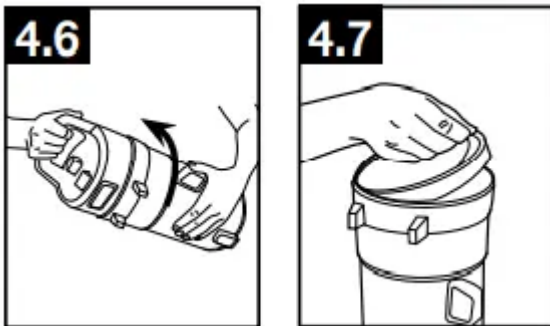

4.8 Replace dirt cup lid and twist clockwise until locked in position.

Replace dirt cup as described in Fig 4.5.



### Cyclonic Filter Assembly: How to Clean

Remove dirt cup and twist the dirt cup handle counterclockwise to open and remove lid as described in 4.6.

4.9 Pull filter assembly (G) out of dirt cup and remove.

4.10 Dirt and debris can be cleaned from the filter assembly with the adjustable dusting brush.

4.11 Place the filter assembly on the dirt cup. Line up tabs (H) on lid with dirt cup body.

4.12 Replace dirt cup lid and twist clockwise until locked in position.

Replace dirt cup as described in Fig 4.5.

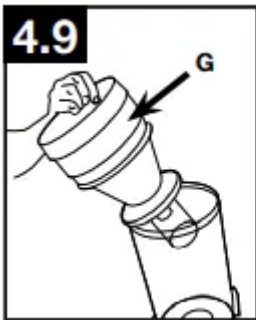

### Filter Made With HEPA Media: How to Clean

4.13 With fingers under filter door lip, pull filter frame (A) out and away from vacuum body. Hold filter over a trash receptacle and tap out dirt and debris.

4.14 Bottom filter (B) must be pushed back into place first.

4.15 Then push the upper handle in (C) until it clicks.

4.16 Filter diagram: (B) bottom filter. (C) upper handle.

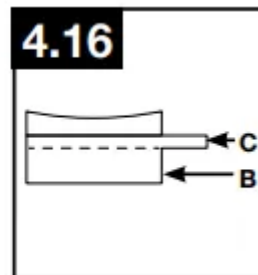
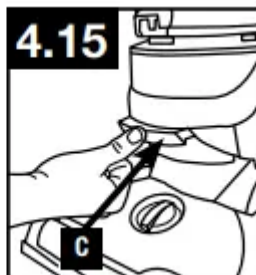
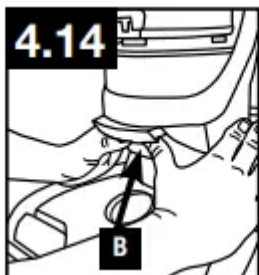
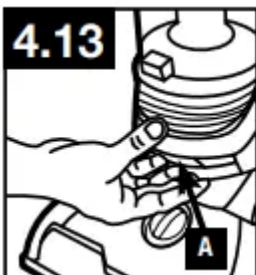

### BRUSHROLL: How to Clean

CAUTION ! To reduce the risk of injury from moving parts - Unplug before servicing.

### **Brushroll - Bottom plate with screws**

Place handle in the low position and turn the cleaner over so the bottom side is up.

4.17 Remove the 6 screws as shown with a Phillips screwdriver.

4.18 Pivot off bottom plate.

4.19 Remove any debris and/or hair from brushroll.

Replace the bottom plate aligning the screw holes and install the 6 screws as shown.

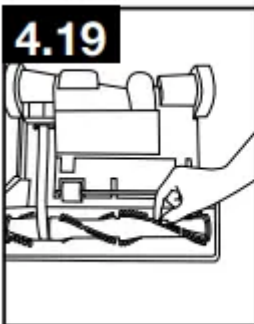

### **BELT**

The belt is located under the bottom plate of the vacuum and should be checked from time to time to be sure it is in good condition.

#### **When To Replace**

Replace belt if it is damaged, cut or broken. Refer to directions below.

#### **How To Replace - Bottom plate with screws**

Place handle in the low position and turn the cleaner over so the bottom side is up.

4.20 Remove the 6 screws as shown with a Phillips screw driver.

4.21 Lift off bottom plate (A).

4.22 Remove used belt from brushroll (C) then from motor shaft (metal rod) (D) and discard.

4.23 With lettering on outside of belt, slide new belt over motor shaft (metal rod) (E).

Then slip around area of brushroll without bristles (G).

4.24 With belt in place, pull and slide brushroll into nozzle making sure that the brushroll end caps are in the correct orientation.

Place the bottom plate aligning the screw holes and re-install the 6 screws.

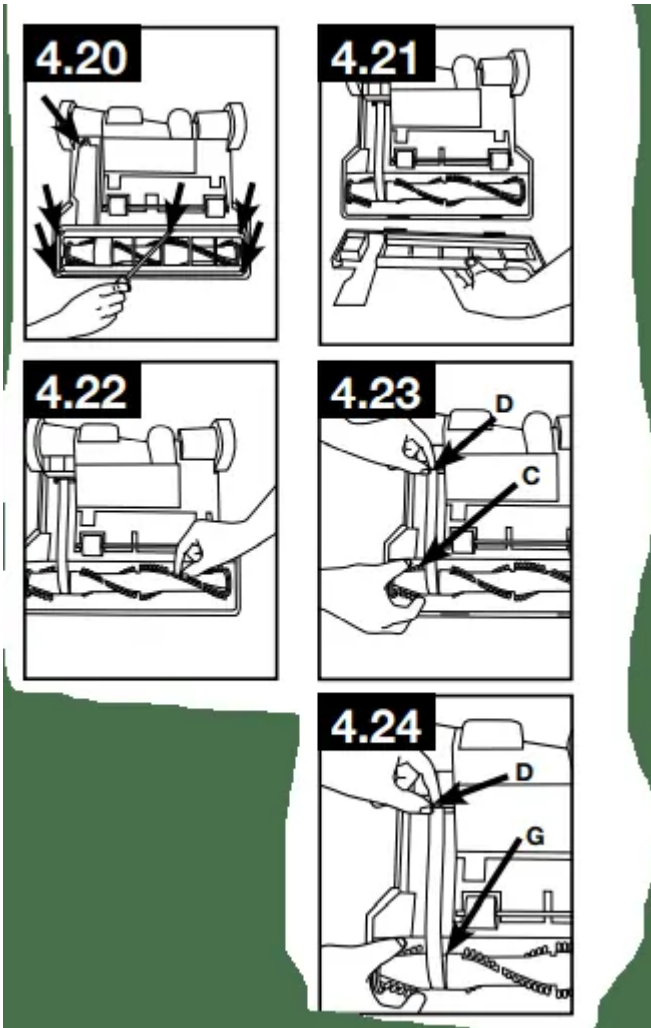

## HOSE

### How to Clean

4.25 To remove hose for tool use, press the hose release button (A) and pull hose end out.

Clear away debris or obstructions from hose. Do not use sharp objects to clean out hose as they can cause damage. To lock back into place, push hose into hose tube until you hear a click.

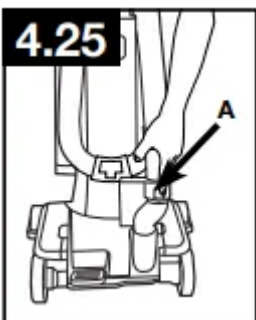

## POWERED HAND TOOL: How to Clean (Tool varies per model)

4.26 Clean the Turbo Tool by removing the two screws (A), located on the bottom cover, with a Phillips head screwdriver.

4.27 Remove the bottom cover (B). Clean out any debris or hair from the brushroll and turbine fan.

4.28 Replace the bottom cover, insert and tighten the (2) screws.

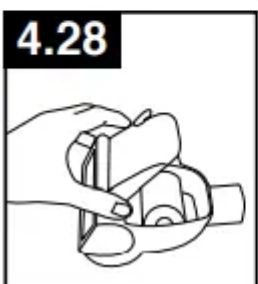
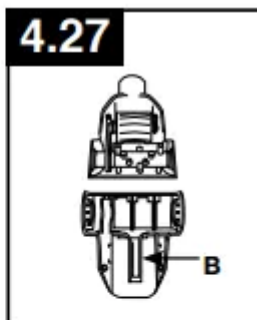
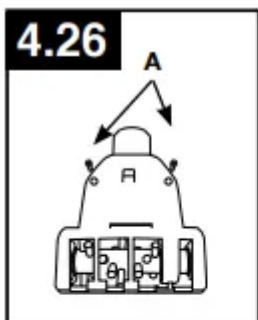

## LUBRICATION

The motor and brushroll are equipped with bearings which contain sufficient lubrication for their lifetime.

The addition of lubricant could cause damage. Do not add lubricant to motor or brushroll.

## TROUBLESHOOTING

If a minor problem occurs, it usually can be solved quite easily when the cause is found by using the checklist below.

Any other servicing should be done by an authorized service representative. If appliance is not working as it should, has been dropped, damaged, left outdoors, or dropped into water, take it to a service center prior to continuing use.

### Vacuum won't run

- Power cord not firmly plugged into outlet.
  - Plug unit in firmly.
- Blown fuse or tripped breaker.
  - Check fuse or breaker in home. Replace fuse/reset breaker in home.

- Thermal Protector activated.
  - Unplug and allow vacuum to cool for 30min. (This will reset the thermal protector)

**System Check Indicator has turned red or Vacuum won't pick up or Low suction**

- Rinsable Filter and/ or Filter made with HEPA media is dirty.
  - Clean Rinsable Filter and or Filter made with HEPA media
- Dirt cup full and/ or clogged.
  - Empty dirt cup
- Broken or worn belt.
  - Replace belt
- Brushroll and/ or Hose clogged.
  - Check Hose Check Brushroll
- Carpet height setting is incorrect.
  - Set Carpet Height Adjustment to appropriate setting for carpet being cleaned
- Suction Only Mode is ON.
  - Step on Brushroll ON/OFF Pedal to turn Suction Only Mode OFF

**Cord Rewind does not work**

- Cord reel does not retract.
  - Call 1-800-944-9200 for the nearest authorized service representative

**Dust escaping from vacuum**

- Dirt cup full
  - Empty dirt cup
- Dirt cup not installed correctly.
  - Review Dirt Cup removal & replacement
- Hose not installed correctly.
  - Review Hose installation
- Rinsable and/ or Filter made with HEPA media not installed completely.
  - Review Filter Removal and Cleaning



### **Vacuum is difficult to push or won't move forward**

- Carpet height setting is incorrect.
  - Set Carpet Height Adjustment knob to appropriate setting for carpet being cleaned

### **Turbo Tool brushroll won't turn**

- Too much pressure being applied to tool.
  - Continue using tool applying light pressure.
- Blockage.
  - Remove blockage
- Low vacuum suction.
  - Check items under "Vacuum won't pick or Low suction."

### **Smoky/burning smell detected**

- Belt broken or stretched.
  - Replace brushroll belt
- Brushroll is clogged.
  - Clear/ remove debris from brushroll

#### **Warning**

This content is compiled from multiple sources and is provided for reference purposes only. It may not be complete or fully applicable to all situations. If you are unable to resolve your issue, please contact the product manufacturer or an authorized service provider for official support.