

CONTROL PANEL AND FEATURES

Not all features and cycles are available on all models.

NOTES:

- The control panel features a sensitive surface that responds to a light touch of your finger. To ensure your selections are registered, touch the control panel with your fingertip, not your fingernail. When selecting a setting or option, simply touch its name.
- At cycle completion, your setting and option choices will be remembered for your next use of that cycle. However, if power is lost to the washer, the settings and options will go back to the factory defaults.

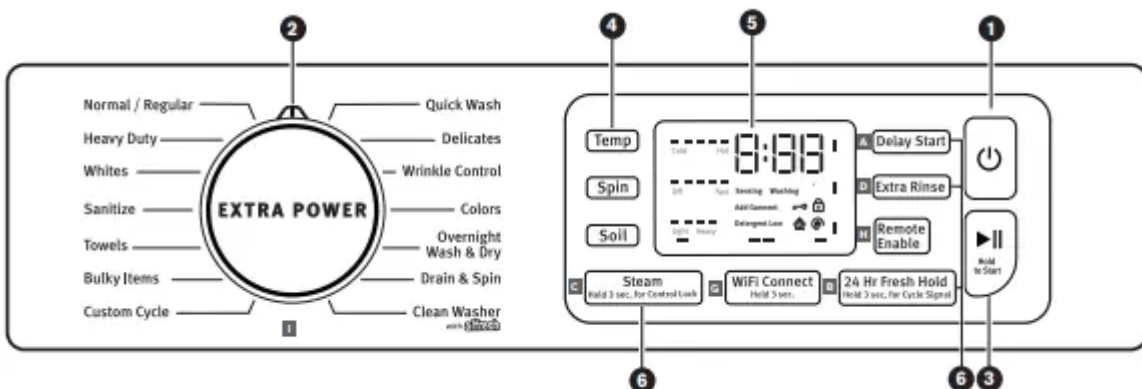
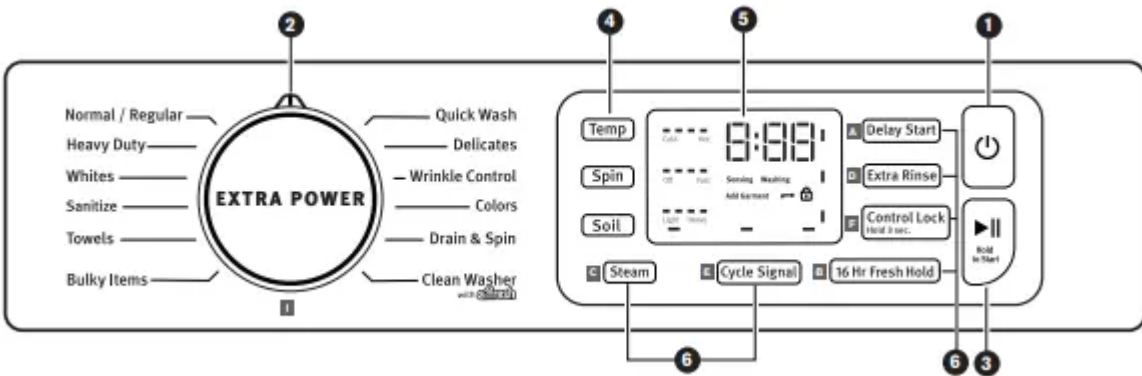
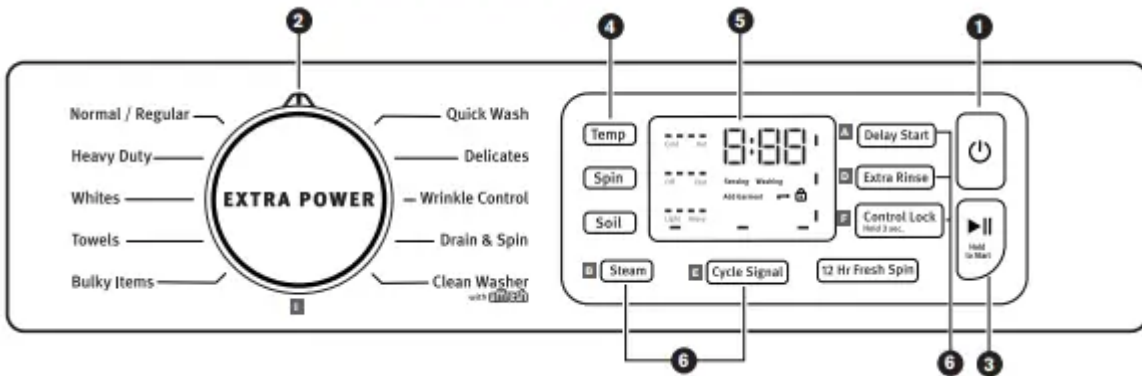

1. POWER

Touch to turn the washer on and off. Touch to stop/cancel a cycle at any time.

NOTE: Turning the Wash Cycle knob will also turn the washer on.

2. WASH CYCLE KNOB

Turn the knob to select a cycle for your laundry load. Press the Wash Cycle knob to enable the Extra Power option.

NOTE: The Clean Washer with affresh® LED will flash when the washer has run 30 wash cycles as a reminder to run the Clean Washer with affresh® cycle.

See “Cycle Guide” for detailed descriptions of cycles.

NOTE: For best results when using the Overnight Wash & Dry cycle, use for loads weighing 2 lbs or less, such as a soccer uniform or a running tank and shorts. Allow the cycle to run the full duration of 12 hours.

EXTRA POWER

Extra Power option can be used for increased cleaning power. Press the Wash Cycle Knob to activate the Extra Power option, which runs a cold pre-wash cycle before the main cycle. When Extra Power is activated, the Cycle Control Knob will illuminate and the estimated time remaining on the display will increase. On single load dispenser models, add an extra dose of detergent to the Bleach/Detergent for Extra Power compartment when using Extra Power, for best results.

3. START

Touch and hold for 3 seconds until the light above START comes on to start a cycle or touch once while a cycle is in process to pause it. If you want to add a garment, you can touch START when the “Add Garment” LED is on.

4. LED DISPLAY AND SETTINGS

When you select a cycle, its default settings will light up and the Estimated Time Remaining will be displayed. Factors such as load size, wash temperature, and water pressure may affect the time shown in the display. Tightly packing, unbalanced loads, or excessive suds may cause the washer to lengthen the cycle time as well.

Touch the desired setting on the display to adjust. See “Cycle Guide” for available settings on each cycle. Not all settings are available with all cycles.

Temp

- The recommended wash temperature is preset for each cycle. You may also select a wash temperature based on the type of fabric and soils being washed. For best results, use the warmest wash water safe for your fabric, following the garment label instructions. All wash temperatures feature a cold rinse.

Spin

This washer automatically selects the spin speed based on the cycle selected. Some preset speeds can be changed.

- Faster spin speeds mean shorter dry times but may increase wrinkling in your load.
- Slower spin speeds reduce wrinkling but will leave your load more damp.

Soil

Soil Level (wash time) is preset for each wash cycle. When you change the soil setting, the cycle time will increase or decrease in the Estimated Cycle Time display.

For most loads, use the soil level that is preset with the cycle you have chosen. For heavily soiled and sturdy fabrics, use the Soil Level setting to select a higher soil level. For lightly soiled and delicate fabrics, use the Soil Level setting to select a lower soil level. Lower soil level settings will help reduce tangling and wrinkling.

5. CYCLE STATUS LIGHTS

NOTE: Not all Cycle Status Lights are available on all models.

The Cycle Status Lights show the progress of a cycle. At each stage of the process, you may notice sounds or pauses that are different from traditional washers.

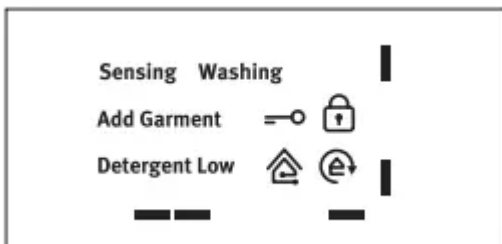

Sensing

- When START is touched and held, the washer will first perform a self-test on the door lock mechanism and the sensing light will come on. You will hear a click, the drum will make a partial turn, and the door will click again as it unlocks briefly. The door will click one more time when it locks again.
- Once the door has locked the second time, the washer will begin spinning to sense the load size. This sensing process will continue throughout the cycle. You may also hear water flowing through the dispenser, adding detergent to the load.
- After the load size is sensed, the estimated time based on load size will be displayed. The actual cycle time may be lengthened; however, the display will continue to show the estimated time.
- The sensing light will blink once a second at various times during the cycle, such as when the washer is reducing extra suds.

Washing

- During the wash cycle, this will display to let you know the cycle is in progress.

Add Garment

- When “Add Garment” is lit, you may pause the washer, open the door, and add items. Touch and hold START to start the washer again.

Detergent Low

- When detergent in the dispenser is running low, the display will show the detergent level (Low).

6. OPTIONS

Touch to activate additional wash options or additional features on the washer. Not all options are available on all models

A. Delay Start

Touch this option to delay the start of the wash cycle by up to 12 hours.

B. Fresh Hold®/Fresh Spin™

The Fresh Hold®/Fresh Spin™ option will periodically tumble the load after the end of the cycle for up to 24 hours while the integrated fan circulates air through the washer to reduce humidity. Fresh Spin™ also periodically tumbles the load after the end of the cycle but does not use an integrated fan. To turn on the Fresh Hold®/Fresh Spin™ option, touch FRESH HOLD. If, however, the Fresh Hold®/Fresh Spin™ option is turned on, it will stay on for all future cycles until turned back off – the washer remembers the last on/off status set. To turn off the Fresh Hold®/Fresh Spin™ option, touch FRESH HOLD.

To turn off the Fresh Hold®/Fresh Spin™ option when it is running, touch POWER.

NOTE: The door will lock while the Fresh Hold®/Fresh Spin™ option is active. To cancel the option and unlock the door, touch POWER.

C. Steam

The Steam option adds additional soak and wash time to many cycles to help remove tough stains as well as a steam boost for added cleaning power. An integrated heater helps to maintain optimal wash temperatures.

D. Extra Rinse

Activate this option to add an extra rinse to most cycles.

E. Cycle Signal

Touch and hold CYCLE SIGNAL for about 3 seconds the display will count down you will see “3,” then “2,” then “1.” The display will start displaying the sound levels you will

see “1,” then “2,” then “3,” then “OFF.” When the CYCLE SIGNAL is released the last value shown will be the current selection.

F. Control Lock

Touch and hold for 3 seconds to lock the controls to avoid unwanted changes or operation. Touch and hold 3 seconds again to unlock. For each second CONTROL LOCK is held down, the display will count down 1 second; you will see “3,” then “2,” then “1.” You may still touch START to pause the cycle or touch POWER to turn off the washer.

G. WiFi Connect

Download the Maytag™ app and follow the instructions to connect your washer/dryer to your home Wi-Fi network.

H. Remote Enable

Touch this button to be able to use the Maytag® app to control the washer. Press this button each time after Power On and when the door is opened and closed.

I. Extra Power

The Extra Power option boosts stain fighting performance on any wash cycle with a dual temperature wash, combining cold and hot temperature during different phases of the wash time. To use this function press the knob to activate the Extra Power option. For single dose dispensers and an additional 1/2 the manufacturer’s recommended amount into the dispenser marked for Extra Power. For the Optimal Dispenser it will automatically dispense the detergent at the optimal time.

7. DISPENSERS

Optimal Dispense Drawer (on some models)

The Optimal Dispense drawer gives you the convenience of automatically adding HE detergent, liquid chlorine bleach, and liquid fabric softener to the wash load at the proper time. See “Using the Optimal Dispense Drawer” for information on using the dispenser drawer.

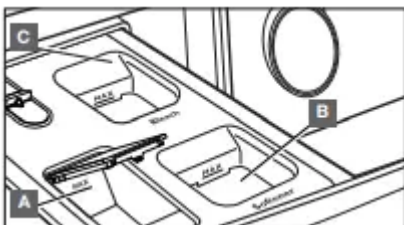

Single Load Dispenser Drawer (on some models)

The dispenser drawer gives you the convenience of adding HE detergent, liquid chlorine bleach, and liquid fabric softener to the wash load at the proper time. See “Using the Dispenser Drawer” for information on using the dispenser drawer.

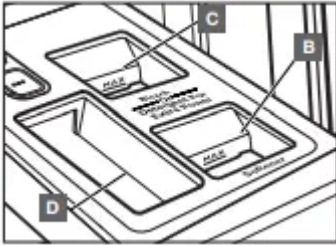





CYCLE GUIDE







Settings and options shown in bold are default settings for that cycle. For best fabric care, choose the cycle, options, and settings that best fit the load being washed. Not all settings are available with each cycle and some options cannot be used together.

Not all cycles and options are available on all models.

Load Size Recommendations

For best results, follow the load size recommendations noted for each cycle.

-  Small load: Fill the washer drum with 3–4 items, not more than $\frac{1}{4}$ full.
-  Medium load: Fill the washer drum up to about $\frac{1}{2}$ full.
-  Large load: Fill the washer drum up to about $\frac{3}{4}$ full.
-  Extra-large load: Fill the washer drum, but make sure clothes can tumble freely. For best results, avoid packing tightly.







Items to wash using default cycle settings:	Cycle:	Wash Temperature*	Spin Speed***	Soil Level:	Options/Modifiers:	Cycle Details:
Normally soiled cottons, linens, sheets, and mixed garment loads	Normal	Cold Cool Warm Very Warm Hot	Off Medium Med Fast Fast	Light Medium Med Heavy Heavy	Steam** Extra Rinse Fresh Hold®/Fresh Spin™ Extra power	 This cycle combines medium-speed tumbling and an extra-high-speed spin. This cycle is designed to provide the most energy efficiency.
Sturdy colorfast fabrics and heavily soiled garments	Heavy Duty	Cold Cool Warm Very Warm Hot	Off Slow Medium Med Fast Fast	Light Medium Med Heavy Heavy	Steam** Extra Rinse Fresh Hold®/Fresh Spin™ Extra power	 Fast-speed tumbling and an extra-fast-speed final spin help provide optimal cleaning and reduce drying times.
Heavily soiled white fabrics and garments	Whites	Cold Cool Warm Very Warm Hot	Off Slow Medium Med Fast Fast	Light Medium Med Heavy Heavy	Steam** Extra Rinse Fresh Hold®/Fresh Spin™ Extra power	 Uses a longer wash time with fast-speed tumbling, extra rinsing, and an extra-fast-speed spin to provide optimal cleaning and rinsing when bleach is used.
Sturdy towels and wash cloths	Towels	Cold Cool Warm Very Warm Hot	Off Slow Medium Med Fast Fast	Light Medium Med Heavy Heavy	Steam** Extra Rinse Fresh Hold®/Fresh Spin™ Extra power	 Provides fast-speed tumbling, longer wash time, normal rinsing, and an xtrafast- speed spin to shorten drying time.
Large items such as sleeping bags, small comforters, jackets	Bulky Items	Cold Cool Warm Very Warm Hot	Off Slow Medium Med Fast Fast	Light Medium Med Heavy Heavy	Steam** Extra Rinse Fresh Hold®/Fresh Spin™ Extra power	 Use this cycle to wash large items such as jackets and small comforters. The washer will fill with enough water to wet down the load before the wash portion of the cycle begins. Do not tightly pack basket.
Small loads of 2-4 lightly soiled garments	Quick Wash	Cold Cool Warm Very Warm Hot	Off Slow Medium Med Fast Fast	Light Medium Med Heavy Heavy	Steam** Extra Rinse Fresh Hold®/Fresh Spin™ Extra power	 For small loads (2-4 items) needed quickly. This cycle combines fast-speed tumbling, a shortened wash time, and an extra-fast-speed spin for reduced drying times.

*All temperature selections feature a Cold rinse.

**The Steam option is only available when a Warm, Very Warm, or Hot water temperature is selected.

***Spin speed varies by model.



Items to wash using default cycle settings:	Cycle:	Wash Temperature*	Spin Speed***	Soil Level:	Options/Modifiers:	Cycle Details:
Sheer fabrics, lingerie, sweaters, and lightly soiled shirts, blouses, trousers, pants, and skirts	Delicates	Cold Cool Warm Very Warm Hot	Off Slow Medium Med Fast Fast	Light Medium Med Heavy Heavy	Steam** Extra Rinse Fresh Hold®/Fresh Spin™ Extra power	 This cycle combines slow-speed tumbling and slow-speed spin for gentle fabric care and reduced wrinkling.
Lightly soiled shirts, blouses, trousers, pants, and dresses	Wrinkle Control	Cold Cool Warm Very Warm Hot	Off Slow Medium Med Fast Fast	Light Medium Med Heavy Heavy	Steam** Extra Rinse Fresh Hold®/Fresh Spin™ Extra power	 This cycle combines low-speed tumbling and medium-speed spin for gentle fabric care and reduced wrinkling.
Clothing, bedding and towels requiring sanitization	Sanitize	Hot	Off Slow Medium Med Fast Fast	Light Medium Med Heavy Heavy	Steam** Extra Rinse Fresh Hold®/Fresh Spin™ Extra power	 This cycle eliminates 99.99% of the most common bacteria found in clothes, sheets, and towels. The extra hot wash temperature ensures sanitization. Check recommended wash temperature of your items. Bacteria tested were K. pneumonia, P. aeruginosa, and S. aureus.
Bright or darkly colored cottons, linens, casual and mixed loads	Colors	Cold	Off Medium Med Fast Fast	Light Medium Med Heavy Heavy	Extra Rinse Fresh Hold®/Fresh Spin™ Extra power	 Cold water with an additional wash action gently lifts stains while caring for fabrics. Settings may be adjusted as desired, but must use only cold water settings.
2-4 lightly soiled synthetic garments, athletic uniforms, or workout wear	Overnight Wash & Dry	Cold Cool Warm Very Warm Hot	Fast	Light Medium Med Heavy Heavy	Steam** Extra Rinse Fresh Hold®/Fresh Spin™ Extra power	 This short wash cycle has an extra-high-speed spin followed by intermittent tumbling and fan activation to circulate air through the clothes.
Wet load of clothes	Drain & Spin	N/A	Off Slow Medium Med Fast Fast	N/A	Extra Rinse Fresh Hold®/Fresh Spin™	 Use Drain & Spin to remove excess water from the load. Spin speed can be set to a lower setting.

*All temperature selections feature a Cold rinse.

**The Steam option is only available when a Warm, Very Warm, or Hot water temperature is selected.

***Spin speed varies by model.

Items to wash using default cycle settings:	Cycle:	Wash Temperature*	Spin Speed***	Soil Level:	Options/Modifiers:	Cycle Details:
No clothes in washer	Clean Washer with affresh®	N/A	N/A	N/A	N/A	Use this cycle every 30 washes to keep the inside of your washer fresh and clean. This cycle uses a higher water level. Use with affresh® washer cleaner tablet or liquid chlorine bleach to thoroughly clean the inside of your washer. This cycle should not be interrupted. See "Washer Care." IMPORTANT: Do not place garments or other items in the washer during the Clean Washer with affresh® cycle. Use this cycle with an empty wash tub. See "Washer Care" in "Washer Maintenance."

**All temperature selections feature a Cold rinse.*

***The Steam option is only available when a Warm, Very Warm, or Hot water temperature is selected.*

****Spin speed varies by model.*

USING YOUR WASHER

First wash cycle without laundry

Before washing clothes for the first time, add liquid or powdered HE detergent to the detergent dispenser. Choose the Quick Wash cycle and run it without clothes. Use only HE detergent. This initial cycle serves to ensure the interior is clean and the dispenser drawer is ready for use before washing clothes.

1. Sort and prepare your laundry

Sort items by recommended cycle, water temperature, and colorfastness. Separate heavily soiled items from lightly soiled. Separate delicate items from sturdy fabrics. Treat stains promptly and check for colorfastness by testing stain remover products on an inside seam.

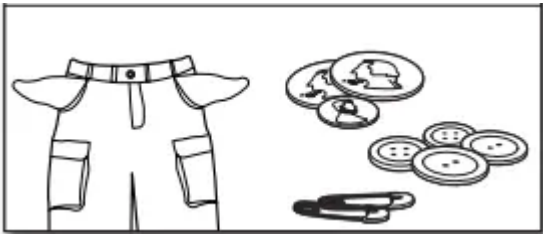

IMPORTANT:

- Empty pockets. Loose change, buttons, or any small object can plug pumps and may require a service call.
- Close zippers, fasten hooks, tie strings and sashes, and remove non-washable trim and ornaments.
- Mend rips and tears to avoid further damage to items during washing.
- Turn knits inside out to prevent pilling. Separate lint-takers from lint-givers. Synthetics, knits, and corduroy fabrics will pick up lint from towels, rugs, and chenille fabrics.
- Do not dry garments if stains remain after washing because heat can set stains into fabric.
- Always read and follow fabric care labels and laundry product instructions. Improper usage may cause damage to your garments.

2. Add laundry products (if desired)

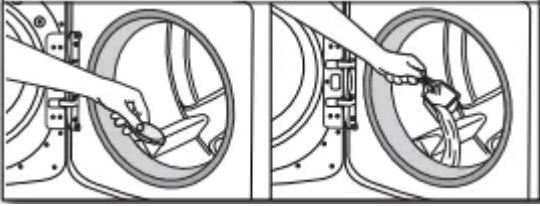

Single-dose laundry packets, Oxi-type boosters, color-safe bleach, or fabric softener crystals can be added to the drum prior to adding laundry.

NOTE: Always follow manufacturer's instructions.

3. Load laundry into washer

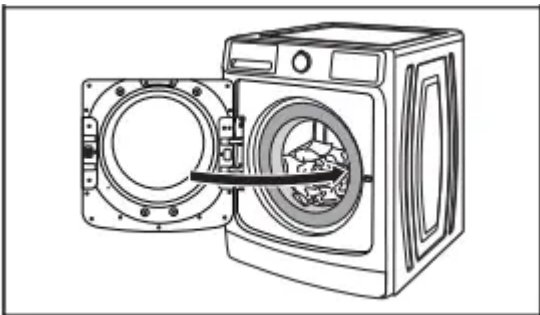

Place a load of sorted items loosely in the washer. Items need to move freely for best cleaning and to reduce wrinkling and tangling. Close the washer door by pushing it firmly until the latch clicks.

- Depending on load type and cycle, the washer can be fully loaded but not tightly packed. Washer door should close easily. See “Cycle Guide” for loading suggestions.
- Mix large and small items and avoid washing single items. Load evenly.
- Wash small items in mesh garment bags. For multiple items, use more than one bag and fill bags equally.

4. Add HE detergent

Optimal Dispense Drawer

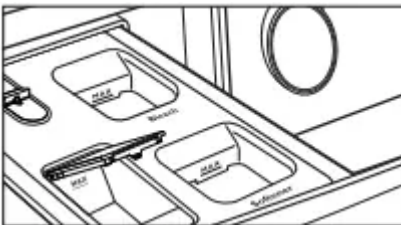

If using the optimal dose dispenser, do not need to add detergent for every load, the dispenser will take automatically.

Single Load Dispenser Drawer

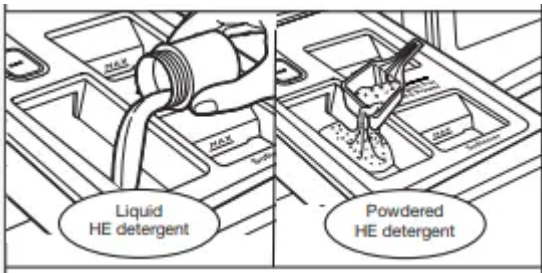

Adjust the selector, based on type of HE detergent used (either liquid or powdered). See “Using the Dispenser Drawer” section on how to use the dispenser.

- Push load fully into washer. Make sure no items are resting on the rubber seal to avoid trapping them between the seal and the door glass.

NOTE: Do not add single-dose laundry packets, Oxi-type boosters, color-safe bleach, or fabric softener crystals to dispensers. They will not dispense correctly.

5. Add liquid fabric softener to dispenser (if desired)

Optimal Dispense Drawer

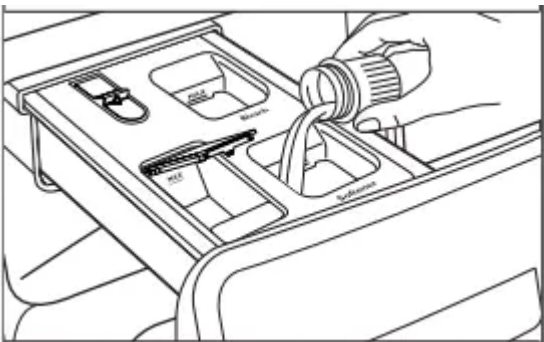

Single Load Dispenser Drawer

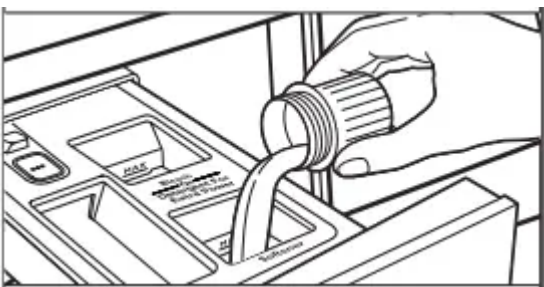

Pour a measured amount of liquid fabric softener into liquid fabric softener compartment. Always follow manufacturer's directions for correct amount of fabric softener based on your load size.

Fabric softener is always dispensed in the last rinse, even if Extra Rinse is selected.

IMPORTANT: Do not overfill, dilute, or use more than manufacturer's recommendation for dosing of fabric softener. Do not fill past the Max line. Overfilling dispenser will cause fabric softener to immediately dispense into washer.

- Do not spill or drip any fabric softener onto the clothes.

- Do not use liquid fabric softener dispenser balls in this washer. They will not dispense correctly

6. Add liquid chlorine bleach to dispenser (if desired)

Optimal Dispense Drawer

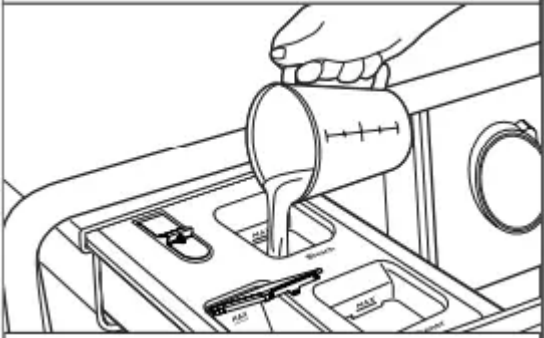

Single Load Dispenser Drawer

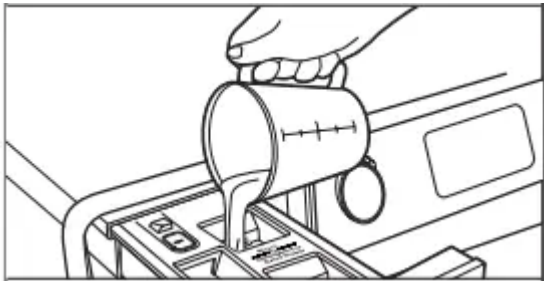

Add liquid chlorine bleach to the bleach compartment. Do not overfill, dilute, or use more than manufacturer's recommendation for dosing. Do not use color-safe bleach or Oxi in the same cycle with liquid chlorine bleach.

IMPORTANT:

- Always measure liquid chlorine bleach. Use a measuring cup with a pour spout; do not guess.
- Do not fill beyond the Max level. Overfilling could cause garment damage.
- Do not use thickened, easy-pour, or no-splash bleach when running the Clean Washer with affresh® cycle as excess suds may occur.

7. Touch **POWER** to turn on washer

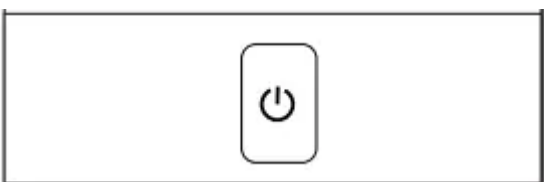

Slowly close the Dispense drawer. Make sure the drawer is closed completely, then touch **POWER** to turn on the washer or go to Step 8.

8. Select CYCLE*

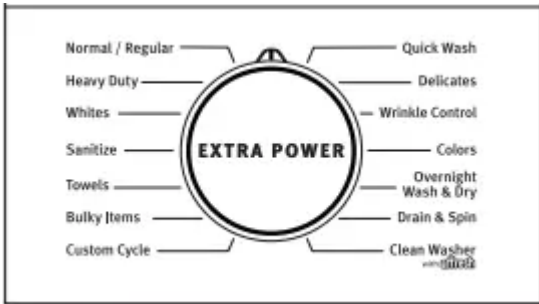

Turn cycle knob to select your wash cycle. See “Cycle Guide” for details on cycle features. Press the knob for enabling the Extra Power option.

The Extra Power option boosts stain fighting performance on any wash cycle with a dual temperature wash, combining cold and hot temperature during different phases of the wash time. Press the knob to select this option.

9. Adjust settings, if desired*

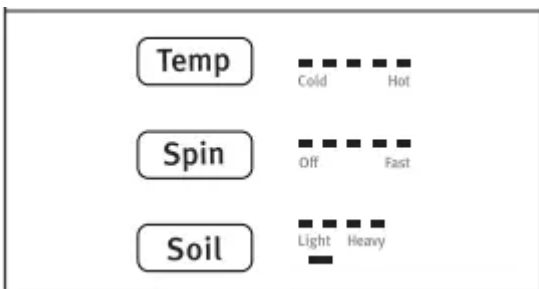

The display will show the default settings for the selected cycle. To adjust a setting, touch its name – Temp, Spin or Soil.

Adjusting settings will change the Estimated Cycle Time. Tightly packing the load, unbalanced loads, or excessive suds may also cause the washer to increase the cycle time.

10. Select any additional options*

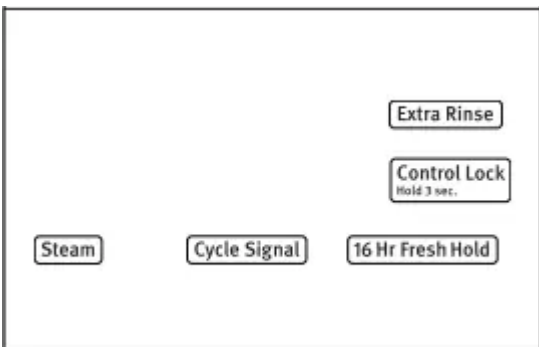

To add an option to the cycle, touch its name – Fresh Hold, Steam, Extra Rinse, Cycle Signal, or Control Lock. To remove an option from the selected cycle, touch the option again.

11. Set detergent concentration (On Optimal Dispense Model only)

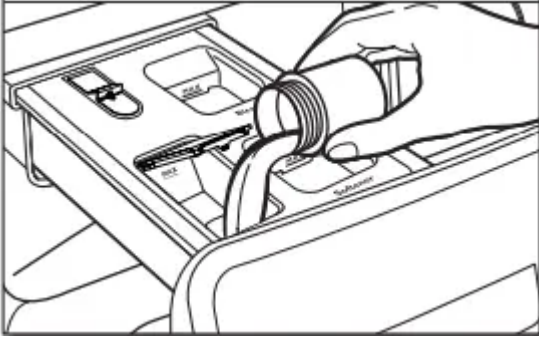

You can adjust the detergent concentration setting if needed. Default settings are 2x detergent concentration. If the detergent concentration is not listed on the package, see “About Detergent Concentration” to calculate the concentration.

To Adjust Dispenser Settings:

Press and hold the Temp & Soil until the display shows the desired concentration level.

The washer will remember this level until it is changed.

12. Set a delayed wash

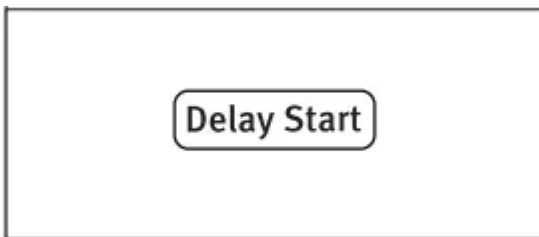

If you do not want to begin a cycle immediately, you may choose the Delay Hrs. option. This will delay the start of the wash cycle by up to 12 hours.

To set a delayed wash:

1. Touch SELECT Delay Start to set the desired delay time.
2. Touch and hold START to start the delay countdown. The countdown stops blinking.

13. Touch and hold START to begin wash cycle

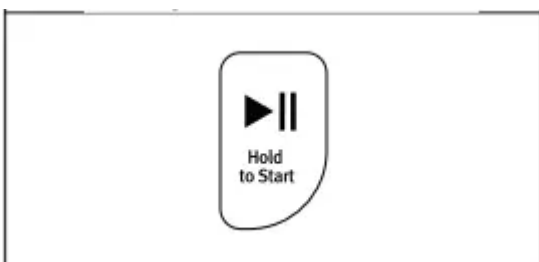

Touch and hold START to start the wash cycle. To pause a cycle in progress, touch START once, then touch and hold again to continue the cycle. To cancel a cycle, touch POWER.

Once you touch and hold START, you will hear the door lock, unlock, and lock again. The washer door will remain locked during the wash cycle.

Unlocking the door to add garments:

If you need to open the door to add 1 or 2 missed garments, you may do so while the “Add Garment” light is lit. The time allowed to add a garment will vary based on cycle selection and load size.

Touch START once; the door will unlock once the washer movement has stopped. This may take several minutes. Then close the door and touch and hold START again to restart the cycle.

Adding items after “Add Garment” light is off:

Cancel current cycle. Water will drain and you will need to reselect cycle and restart.

For wash performance and optimal energy savings, add garments only when the “Add Garment” light is on.



14. Remove garments promptly after cycle is finished



Promptly remove garments after cycle has completed to avoid odor and rusting of metal objects on garments. When unloading garments, pull back the door seal and check for small items between the tub and the washer drum.

If you will be unable to remove the load promptly, use the Fresh Hold®/Fresh Spin™ option. If the Fresh Hold®/Fresh Spin™ option is selected, the washer will automatically activate the fan and tumble the load periodically for up to 24 hours. To turn off the Fresh Hold®/Fresh Spin™ option, touch POWER. To set the washer so that the Fresh Hold®/Fresh Spin™ option does not come on for future cycles, touch FRESH HOLD.

NOTES:

- The door will remain locked while the Fresh Hold®/Fresh Spin™ option is active. To cancel the option and unlock the door, touch POWER.
- A small amount of water may remain in the dispensers after the wash cycle is complete. This is normal.
- This washer has a tight seal to avoid water leaks. To avoid odors, leave the door open to allow the washer to dry between uses.

WASHER MAINTENANCE

WATER INLET HOSES

Replace inlet hoses after 5 years of use to reduce the risk of hose failure. Periodically inspect and replace inlet hoses if bulges, kinks, cuts, wear, or leaks are found.

When replacing your inlet hoses:

- Mark the date of replacement on the label with a permanent marker.
- Check that the old washers are not stuck on the washer inlet valves.
- Use new washers in the new inlet hoses to ensure a proper seal.

WASHER CARE

Recommendations to Help Keep Your Washer Clean and Performing at Its Best

1. Always use High Efficiency (HE) detergents and follow the HE detergent manufacturer's instructions regarding the amount of HE detergent to use. Never use more than the recommended amount because that may increase the rate at which detergent and soil residue accumulate inside your washer which, in turn, may result in undesirable odor.
2. Use warm or hot water washes sometimes (not exclusively cold water washes) because they do a better job of controlling the rate at which soils and detergent accumulate.
3. Always leave the washer door slightly ajar between uses to help dry out the washer and avoid the buildup of odor-causing residue.
4. Periodically clean residue from all interior surfaces of the glass window. For better care, wipe the entire inside of the glass door with a damp cloth.

Cleaning Your Front-Loading Washer

- Read these instructions completely before beginning the routine cleaning processes recommended below.
- This Washer Maintenance Procedure should be performed, at a minimum, once per month or every 30 wash cycles, whichever occurs sooner, to control the rate at which soils and detergent may otherwise accumulate in your washer.

Cleaning the Door Seal

1. Open the washer door and remove any clothing or items from the washer.
2. Inspect the gray-colored seal between the door opening and the drum for stained areas or soil buildup. Pull back the seal to inspect all areas under the seal and to check for foreign objects.
3. If stained areas or soil buildup is found, wipe down these areas of the seal using either of the following two procedures:
 - a. affresh® Machine Cleaning Wipes Procedure:
 - i. When the cycle is complete, gently pull back the rubber door seal and clean the entire surface with the textured side of an affresh® Machine Cleaning Wipe
 - b. Dilute Liquid Chlorine Bleach Procedure:
 - i. Mix a dilute bleach solution, using $\frac{3}{4}$ cup (177 mL) of liquid chlorine bleach and 1 gallon (3.8 L) of warm tap water.
 - ii. Wipe the seal area with the dilute solution, using a damp cloth.
 - iii. Let stand 5 minutes
 - iv. Wipe down area thoroughly with a dry cloth and let washer interior air dry with door open.

IMPORTANT:

- Wear rubber gloves when cleaning with bleach.
- Refer to the bleach manufacturer's instructions for proper use.

Cleaning the Inside of the Washer

This washer has a special cycle that uses higher water volumes in combination with affresh® Washer Cleaner or regular liquid chlorine bleach to thoroughly clean the inside of the washer. Steam washer models also utilize steam to enhance cleaning in this special cycle.

IMPORTANT: Do not use thickened, easy-pour, or no-splash bleach when running the Clean Washer with affresh® cycle as excess suds may occur.

NOTE: Read these instructions completely before beginning the cleaning process.

Begin Procedure

1. Clean Washer with affresh® Cycle Procedure (Recommended for Best Performance):
 - a. Open the washer door and remove any clothing or items.
 - b. Use an affresh® Machine Cleaning Wipe or a soft, damp cloth or sponge to clean the inside door glass.
 - c. Add an affresh® Washer Cleaner tablet to the washer drum.
 - d. Do not add the affresh® Washer Cleaner tablet to the dispenser drawer.

e. Do not add any detergent or other chemical to the washer when following this procedure.

f. Close the washer door.

g. Select the Clean Washer with affresh® cycle.

h. On some models: Select the Fresh Hold®/Fresh Spin™ option to help dry the washer interior after the cycle is complete.

NOTE: The washer remembers your last option selection and will use it for future wash cycles until you deselect that option. While the fan is ON, the washer door will lock. To unlock the door, touch POWER.

i. Touch and hold START to begin the cycle. The Clean Washer with affresh® Cycle Operation is described below.

2. Chlorine Bleach Procedure:

a. Open the washer door and remove any clothing or items.

b. Open the dispenser drawer and add regular liquid chlorine bleach to the MAX level in both the bleach compartment and the fabric softener compartment. Either traditional or HE chlorine bleach can be used.

IMPORTANT: Do not use thickened, easy-pour, or no-splash bleach as excess suds may occur.

NOTE: Use of more liquid chlorine bleach than is recommended above could cause washer damage over time.

c. Close the washer door and the dispenser drawer.

d. Do not add any detergent or other chemicals to the washer when following this procedure.

e. Close the washer door.

f. Select the Clean Washer with affresh® cycle.

g. On some models: Select the Fresh Hold®/Fresh Spin™ option to help dry the washer interior after the cycle is complete.

NOTE: The washer remembers your last option selection and will use it for future wash cycles until you deselect that option. While the fan is ON, the washer door will lock. To unlock the door, touch POWER.

h. Touch and hold START to begin the cycle. The Clean Washer with affresh® Cycle Operation is described below.

NOTE: For best results, do not interrupt cycle.

3. Steam models only:

During the first 20 minutes of the cycle, it will activate the steamer but the drum will not spin or fill with water. You may see condensation on the door glass during this initial phase. If you are using an affresh® Washer Cleaner tablet, it will not dissolve completely during the steam phase. This is normal.

After the cycle is complete, leave the door open slightly to allow for better ventilation and drying of the washer interior.

Cleaning the Dispensers

After a period of using your washer, you may find some residue buildup in the washer's dispensers. To remove residue from the dispensers, remove the drawer and wipe the surfaces with an affresh® Machine Cleaning Wipe or a damp cloth and towel dry either before or after you run the Clean Washer with affresh® cycle. Use an all-purpose surface cleaner, if needed.

IMPORTANT: Dispenser is not dishwasher safe.

Cleaning the Outside of the Washer

Use an affresh® Machine Cleaning Wipe or a soft, damp cloth or sponge to wipe up any spills. Occasionally wipe the outside of your washer to help keep it looking new. Use an affresh® Machine Cleaning Wipe or mild soap and water.

IMPORTANT: To avoid damaging the washer's finish, do not use abrasive products.

CLEAN WASHER CYCLE REMINDER

NOTE: Not all models have the Clean Washer with affresh® cycle reminder light.

The Clean Washer with affresh® LED will flash at the end of a wash cycle when the washer has run 30 wash cycles. This is a reminder to run the Clean Washer with affresh® cycle.

If the Clean Washer with affresh® cycle is not turned on, the LED will stop flashing at the end of a wash cycle after running 3 more regular wash cycles. After 30 more wash cycles are completed, the Clean Washer with affresh® LED will again flash at the end of a wash cycle as a reminder



WINTER STORAGE CARE

IMPORTANT: To avoid damage, install and store washer where it will not freeze. Because some water may stay in hoses, freezing can damage washer. If storing or moving during freezing weather, winterize your washer.

To winterize washer:

1. Shut off both water faucets, then disconnect and drain water inlet hoses. **HELPFUL TIP:** Attach a reminder note to the washer to turn the water back on before washer's next use.
2. Put 1 qt (1 L) of R.V.-type antifreeze in washer drum and run washer on Normal cycle for about 2 minutes to mix antifreeze and remaining water.
3. Unplug washer or disconnect power.

TRANSPORTING YOUR WASHER

1. Shut off both water faucets. Disconnect and drain water inlet hoses.
2. If washer will be moved during freezing weather, follow “Winter Storage Care” directions before moving.
3. Disconnect drain hose from drain system and from back of washer.
4. Unplug power cord.
5. Place inlet hoses and drain hose inside washer drum.
6. Bundle power cord with a rubber band or cable tie to keep it from hanging onto the ground.

IMPORTANT: Call for service to install new transport bolts. Do not reuse transport bolts. Washer must be transported in the upright position. To avoid structural damage to your washer, it must be properly set up for relocation by a certified technician.

REINSTALLING/USING WASHER AGAIN

To reinstall washer after non-use, vacation, winter storage, or moving:

1. Refer to Installation Instructions to locate, level, and connect washer.
2. Before using again, run washer through the following recommended procedure:

To use washer again:

1. Flush water pipes and hoses. Reconnect water inlet hoses. Turn on both water faucets.
2. Plug in washer or reconnect power.
3. Run washer through Power Wash cycle to clean washer and remove antifreeze, if used. Use only HE detergent. Use half the manufacturer’s recommended amount for a medium-size load.

TROUBLESHOOTING

Error Code Appears in Display (for 2- and 3-digit displays)

Once any possible issues are corrected, touch POWER once to clear the code. Reselect and restart the cycle.

“Sd” or “Sud” (excess suds) appears in display

- Excessive suds in washer. Washer is running a suds-reduction routine.

Allow the washer to continue. Use only HE detergent. Always follow the detergent manufacturer’s instructions to determine the amount of detergent to use and base detergent quantity on load size. Not all detergents labeled as High Efficiency are identical in formulation and their ability to reduce suds. For example, natural, organic,

or homemade HE detergents may generate a high level of suds. If you use one of these and see an “Sd” or “Sud” error code appear in the display, consider using a different HE detergent.

Lo followed by FL or F8 followed by E1 or Lo followed by FL or F08 followed by E01 (water supply error) appears in display

- Check for proper water supply

Unit will drain for 8 minutes while door remains locked. The drain cycle must be allowed to complete or the error code cannot reset. When complete, touch POWER once to clear the code. Then touch POWER again to restart washer.

If code appears again, call for service.

Both hoses must be attached and have water flowing to the inlet valve.

Both hot and cold water faucets must be ON.

Inlet valve screens on washer may be clogged.

Remove any kinks in the inlet hose.

If used, auto shut-off connectors and hoses must be properly installed and in working order.

- Check for proper inlet hoses.

Use only manufacturer's recommended inlet hoses.

F9 followed by E1 or F09 followed by E01 (drain pump system error) appears in display

- Check plumbing for correct drain hose installation. Drain hose extends into standpipe farther than 41/2" (114 mm).

Check drain hose for proper installation.

Make sure the drain hose is not kinked, pinched, or blocked.

Remove any clogs from drain hose.

Use drain hose form and securely attach to drainpipe or tub.

Lower drain hose if the end is higher than 96" (2.4 m) above the floor.

- Not using HE detergent or using too much HE detergent.

Use only HE detergent. Always measure detergent and follow manufacturer's directions based on load size and soil level.

F5 followed by E2 or F05 followed by E02 (door will not lock) appears in display

- Washer door not locking.

Touch POWER to cancel the cycle. Check that the door is closed completely and latching. Check for items in the washer drum that may be keeping the door from closing completely.

“rL” (remove load) appears in display

- Load detected in drum during Clean Washer with affresh® cycle.

Remove items from washer drum and restart Clean Washer with affresh® cycle.

F# E# or F## E## code other than as described above appears in display

- System error code.

Touch POWER once to clear the code. Then touch POWER again to restart washer. If code appears again, call for service. Unplug washer for 30 seconds, then plug back in.

Washer making error beeps

- Door has not been opened and closed for at least 3 cycles.

This code may occur when the washer is first turned on. Open and close the door to clear the display.

Washer beeps when START is touched

- Door not closed.

Close the door completely.

Clean Washer LED flashing at end of wash cycle (on some models)

- The washer has run 30 wash cycles and is indicating a reminder to run the Clean Washer with affresh® cycle.

Run the Clean Washer with affresh® cycle. If the Clean Washer with affresh® cycle is not turned on, the LED will stop flashing at the end of a wash cycle after running 3 more regular wash cycles. After 30 more wash cycles are completed, the Clean Washer with affresh® LED will again flash at the end of a wash cycle as a reminder.

Vibration or Off-Balance

Vibration, rocking, or “walking”

- Feet may not be in contact with the floor and locked.

Front and rear feet must be in firm contact with floor and washer must be level to operate properly. Jam nuts must be tight against the bottom of the cabinet.

- Washer may not be level.

Check floor for flexing or sagging. If flooring is uneven, a ¾" (19 mm) piece of plywood under your washer will reduce sound. Do not install washer on a raised wooden platform.

See “Level the Washer” in Installation Instructions.

- Load could be unbalanced or too large.

Avoid tightly packing the load. Avoid washing single items. Balance a single item such as a rug or jeans jacket with a few extra items.

Item or load is not suitable for selected cycle. See “Cycle Guide” and “Using Your Washer.”

- The shipping bolts are still in the back of the washer.

See “Remove transport bolts from washer” in the Installation Instructions.

Noises

Clicking or metallic noises

- Door locking or unlocking.

The door will lock, unlock, and lock again. You will hear 3 clicks after touching and holding START. This is normal.

- Objects caught in washer drain system.

Empty pockets before washing. Loose items such as coins could fall between washer drum and tub or may block pump. It may be necessary to call for service to remove items.

It is normal to hear metal items on clothing, such as metal snaps, buckles, or zippers, touch against the stainless steel drum

Gurgling or humming

- Washer may be draining water.

The pump may make a humming sound with periodic gurgling or surging as final amounts of water are removed during the spin/drain cycles. This is normal at certain stages of the cycle.

Rolling or sloshing and occasional clicking (on slow-speed spin)

- Steel balls in the balancing system are balancing the load.

This is normal at certain stages of the cycle.

Water Leaks

Check the following for proper installation

- Fill hoses not attached tightly.

Tighten fill-hose connection.

- Fill-hose washers.

Properly seat all four fill-hose flat washers.

- Drain hose connection.

Check that the drain hose is properly secured to drainpipe or laundry tub.

- Check household plumbing for leaks or clogged sink or drain.

Water can back up out of a clogged sink or drainpipe. Check all household plumbing for leaks (laundry tubs, drain pipe, water pipes, and faucets).

- Strainer (or nylon stocking) on end of drain hose is clogged.

Strainer (or nylon stocking) on end of drain hose is clogged.

Water or suds leaking from door or rear of cabinet

- Not using HE detergent or using too much HE detergent.

Only use HE detergent. Suds from regular detergents can cause leaking from the door or rear of cabinet. Always measure detergent and follow manufacturer's directions based on your load requirements.

- Using thickened, easy-pour, or no-splash bleach when running the Clean Washer with affresh® cycle.

Use affresh® tablet or regular, non-thickened chlorine bleach when running the Clean Washer with affresh® cycle.

- Residue on door glass.

Periodically clean the underside of the glass window to avoid potential leaks.

- Door opened during "Add Garment."

Water can drip off the inside of the door when the door is opened after the start of a cycle.

Leaking around door

- Hair, lint, or other debris on inner door glass preventing proper seal with rubber door seal.

Clean inner door glass and seal. See "Cleaning the Door Seal" in the "Washer Maintenance" section.

Washer not performing as expected

Load not completely covered in water

- Water level not visible on door or does not cover clothes.

This is normal for an HE front-load washer. The washer senses load sizes and adds the correct amount of water for optimal cleaning.

Washer won't run or fill; washer stops working

- Check for proper water supply

Both hoses must be attached and have water flowing to the inlet valve.

Both hot and cold water faucets must be turned on.

Check that inlet valve screens have not become clogged.

Check for any kinks in inlet hoses, which can restrict water flow.

Plug power cord into a grounded 3 prong outlet.

Do not use an extension cord.

Ensure there is power to outlet.

Do not plug into a GFCI (Ground Fault Circuit Interrupter).

Check electrical source or call an electrician to check if voltage is low.

Reset a tripped circuit breaker. Replace any blown fuses.

NOTE: If problems continue, contact an electrician.

- Normal washer operation

Door must be completely closed and latched for washer to run.

Washer will pause during certain phases of cycle. Do not interrupt cycle.

The washer pauses for about 2 minutes during certain cycles. Allow the cycle to continue. Some cycles feature periods of tumbling and soak.

Washer may be stopped to reduce suds. Use only a proper amount of HE detergent.

Cold Wash uses less water in the beginning of the cycle to provide a high concentration of detergent for optimal cleaning action. Following this concentrated tumbling, more water is used to complete the wash.

Steam Models only: During the first 20 minutes of the Clean Washer with affresh® cycle, it will activate the steamer but the drum will not spin or fill with water. You may see condensation on the door glass during this initial phase. If you are using an affresh® Washer Cleaner tablet, it will not dissolve completely during the steam phase. This is normal.

- The washer door is not firmly shut.

The door must be closed during operation.

- Washer not loaded as recommended.

Remove several items and rearrange load evenly in washer drum. Close door, then touch and hold START.

Do not add more than 1 or 2 additional items after cycle has started to avoid tightly packing or unbalancing.

Do not add more water to the washer.

- Not using HE detergent or using too much HE detergent.

Only use HE detergent. Suds from regular detergents can slow or stop the washer. Always measure detergent, following manufacturer's directions based on your load requirements.

To remove suds, cancel cycle. Select DRAIN & SPIN with Extra Rinse. Touch START. Do not add more detergent.

- Door not opened between cycles.

After any wash cycle is completed, the door must be opened and then closed before a new cycle can begin.

Washer not draining/ spinning; loads are still wet

- Drain hose extends into standpipe farther than 4.5" (114 mm).

Check drain hose for proper installation. Use drain hose form and securely attach to drainpipe or tub. Do not tape over drain opening.

- The drain hose is clogged or the end of the drain hose is more than 96" (2.4 m) above the floor.

Lower drain hose if the end is higher than 96" (2.4 m) above the floor. Remove any clogs from drain hose. See "Installation Requirements" in Installation Instructions.

- Strainer/nylon stocking on end of drain hose.

Remove strainer/nylon stocking from drain hose.

- The drain hose fits too tightly in the standpipe or it is taped to the standpipe.

The drain hose should be loose, yet fit securely. Do not seal the drain hose with tape. The hose needs an air gap. See "Secure the Drain Hose" in Installation Instructions.

- Using cycles with a slower spin speed.

Cycles with slower spin speeds remove less water than cycles with fast spin speeds. Use the recommended cycle/ speed spin for your garment.

- Washer not loaded as recommended.

A tightly packed or unbalanced load may not allow the washer to spin correctly, leaving the load wetter than normal. See "Cycle Guide" for load size recommendation for each cycle.

- The load may be out of balance.

Avoid washing single items. Balance a single item, such as a rug or jeans jacket, with a few extra items.

- Not using HE detergent or using too much HE detergent.

Use only HE detergent. Suds from regular detergent or using too much detergent can slow or stop draining or spinning. Always measure and follow manufacturer's directions for your load. To remove extra suds, select DRAIN & SPIN with Extra Rinse. Do not add detergent.

- Small items may have been caught in the pump or stuck between the washer drum and the outer tub.

Check the drum for any items sticking through the drum holes. Empty pockets and use garment bags when washing small items.

- There are too many clothes in the Overnight Wash & Dry cycle.

Only use the Overnight Wash & Dry cycle for 2–4 lightly soiled synthetic garments, athletic uniforms, or workout wear.

Door locked at end of wash cycle

- Water remaining in washer after cycle.

Select DRAIN & SPIN to remove any water remaining in the washer. The washer door will unlock at the end of the drain.

- Fresh Hold®/Fresh Spin™ option is ON.

While this option is ON, the fan blows and the load is tumbled periodically for up to 12 hours. The door remains locked during this time. To unlock the door, cancel the Fresh Hold®/ Fresh Spin™ option by touching POWER.

Door will not unlock

- Door locks when cycle has started.

If the "Add Garment" light is lit, touch START once. The door will unlock.

Load is wrinkled, twisted, or tangled

- Washer not loaded as recommended.

Add load loosely. Items need to move freely to reduce wrinkling and tangling. See the "Cycle Guide" for load size recommendations for each cycle.

Reduce tangling by mixing types of load items. Use the recommended cycle for the type of garments being washed.

- Wash action too long for load.

Select a lower soil level. Note that items will not be cleaned as deeply as when using a higher soil level.

- Spin speed too fast for load.

Select a slower spin speed. Note that items will be wetter than when using a faster speed spin.

- The washer is not unloaded promptly.

Unload the washer as soon as it stops or use Fresh Hold®/Fresh Spin™ option if you will not be able to unload the washer at the end of the cycle.

Not cleaning or removing stains

- Washer not loaded as recommended.

Add load loosely. Items need to move freely for best cleaning. See the “Cycle Guide” for load size recommendations for each cycle.

Add only 1 or 2 garments after washer has started.

- Washer not loaded as recommended.

Use only HE detergent. Always measure detergent and follow manufacturer’s directions based on load size and soil level.

- Hard water or high level of iron (rust) in water.

You may need to install a water softener and/or iron filter.

- Fabric softener dispensing ball used.

Dispensing balls will not operate correctly with this washer. Add liquid fabric softener to the fabric softener compartment.

- Powdered detergent used for slow-speed cycle.

Consider using liquid detergent.

Warning

This content is compiled from multiple sources and is provided for reference purposes only. It may not be complete or fully applicable to all situations. If you are unable to resolve your issue, please contact the product manufacturer or an authorized service provider for official support.