

OWNER'S MANUAL DRYER

PRODUCT FEATURES

- **Easy-to-Use Control Panel:** Rotate the cycle selector knob to select the desired dry cycle. Add cycle options or adjust settings with the touch of a button.
- **Easy-Access Reversible Door:** The wide-opening door provides easy access for loading and unloading. The door hinge can be reversed to adjust for installation location.
- **Steam Functions (Steam Models):** LG's steam technology allows you to inject fabrics with a swirling jet of hot steam to refresh clothes, reduce static, and make ironing easier. Simply select the Steam Fresh™ cycle, or you can add a Steam option to selected cycles.
- **Flow Sense™ Duct Blockage Sensing System Indicator:** The Flow Sense™ duct blockage sensing system detects and alerts you to restrictions in the installed household ductwork that reduce exhaust airflow through the dryer. If you see the alert: Clean or repair the ducts to remove the restrictions. Keep your ducts clean to help increase efficiency and reduce long drying times caused by blocked ducts.
- **Smart Diagnosis™:** Should you experience any technical difficulty with your dryer, it has the capability of transmitting data via your telephone to the Customer Information Center. The call center agent records the data transmitted from your machine and uses it to analyze the issue, providing a fast and effective diagnosis.
- **SmartThinQ™:** Download the new LG smart phone app to set options, self-diagnose and troubleshoot problems with the appliance, and other useful features. This function uses Wi-Fi.



**Protocol P154 Sanitization
Performance of Residential Clothes
dryer**

PRODUCT OVERVIEW

Parts

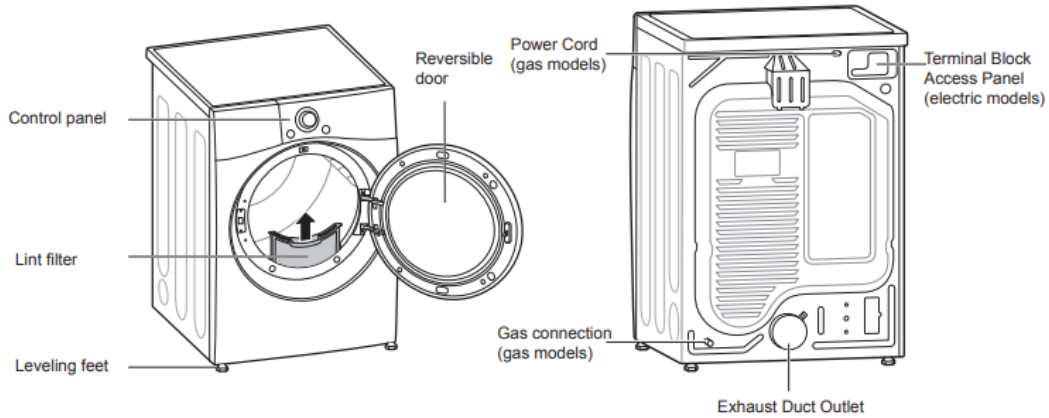

OPERATION

OPERATION: To reduce the risk of fire, electric shock, or injury to persons, read the SAFETY INSTRUCTIONS before operating this appliance.

Using the Dryer

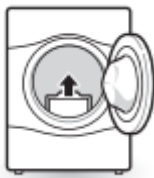

1. Clean the Lint Filter: If the lint filter has not already been cleaned, lift out the filter and remove the lint from the last load. This will help ensure the fastest and most efficient drying performance. Make sure to reinstall the filter, pressing down until it clicks firmly into place.

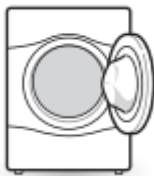

2. Load the Dryer: Load the dryer with the wet laundry from the washer. If the load is extra large, you may need to divide it into smaller loads for proper performance and fabric care.



3. Turn on the Dryer: Press the Power button to turn on the dryer. The cycle LEDs will illuminate and a chime will sound.



4. Select a Cycle: Turn the cycle selector knob either direction until the LED for the desired cycle is on. The preset temperature, dry level, and option settings for that cycle will be shown. Default settings for the selected cycle can now be changed if desired. Refer to the Cycle Setting and Options page for details.



5. Begin Cycle: Press the Start/Pause button to begin the cycle. The cycle can be paused at any time either by opening the door or by pressing the Start/Pause button. If the cycle is not restarted within 4 minutes of being paused, the dryer will shut off and the settings will be lost.



6. End of Cycle: When the cycle is finished, the chime will sound. Immediately remove your clothing from the dryer to reduce wrinkling. If Wrinkle Care is selected, the dryer will tumble briefly every few minutes to help prevent wrinkles from setting in the clothes.

Check the Lint Filter Before Every Load

- Always make sure the lint filter is clean before starting a new load; a clogged lint filter will increase drying time. To clean, pull the lint filter straight up and roll any lint off the filter

with your fingers. Push the lint filter firmly back into place. See Regular Cleaning for more information.

- Always ensure the lint filter is properly installed before running the dryer. Running the dryer with a loose or missing lint filter will damage the dryer and articles in the dryer.

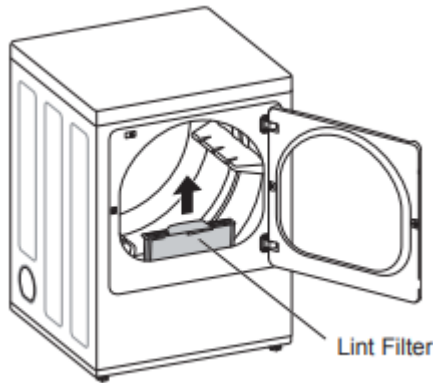

Sorting Laundry

Fabric Care Labels

- Many articles of clothing include a fabric care label. Using the chart below, adjust the cycle and option selections to care for your clothing according to the manufacturer's recommendations.

Tumble dry			
	Dry		Gentle/delicate
	Normal		Do not tumble dry
	Permanent Press/ wrinkle resistant		Do not dry (used with do not wash)
Heat setting			
	High		Low
	Medium		No heat/air

Grouping Similar Items

- For best results, sort clothes into loads that can be dried with the same drying cycle.
- Different fabrics have different care requirements, and some fabrics will dry more quickly than others.

Loading the Dryer

NOTE Loading Tips

- Combine large and small items in the same load.
- Damp clothes will expand as they dry. Do not overload the dryer; clothes require room to tumble and dry properly.
- Close zippers, hooks, and drawstrings to prevent these items from snagging or tangling on other clothes.

Control Panel

Non-Steam Models (DLE3500*, DLG3501*)

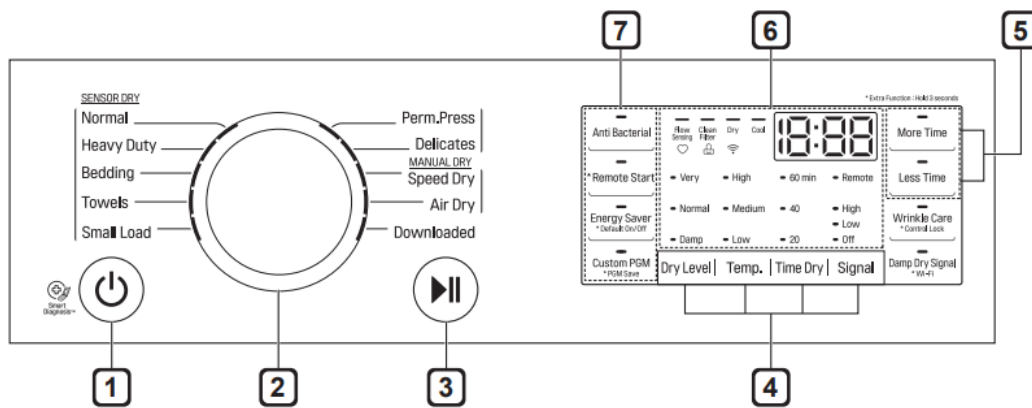

1. Power Button Press the button to turn the dryer ON. Press again to turn the dryer OFF.

NOTE: Pressing the Power button during a cycle will cancel that cycle and any load settings will be lost.

2. Cycle Selector Knob: Turn this knob to select the desired cycle. Once the desired cycle has been selected, the standard presets will be shown in the display. On Manual Dry cycles, these settings can be adjusted using the cycle Modifier buttons anytime before starting the cycle.

3. Start/Pause Button: Press this button to start the selected cycle. If the dryer is running, use this button to pause the cycle without losing the current settings.

NOTE: If you do not press the Start/Pause button to resume a cycle within 4 minutes, the dryer turns off automatically and all cycle settings are lost.

4. Cycle Modifier Buttons: Use these buttons to select the desired cycle settings for the selected cycle. The current settings are shown in the display. Press the button for that option to view and select other settings.

5. More Time/Less Time Buttons: Use these buttons with the Time Dry and other Manual Dry cycles to adjust the drying time. Press the More Time button to increase the selected manual cycle time by 1 minute; press the Less Time button to decrease the cycle time by 1 minute.

6. Time and Status Display: The display shows the settings, estimated time remaining, options, and status messages for the dryer.

7. Cycle Option Buttons: Press each of these buttons to select additional cycle options. And press and hold any button marked with an asterisk for 3 seconds to activate a special function.

8. Steam Functions: LG's steam technology allows you to inject fabrics with a swirling jet of steam to refresh clothes, reduce static, and make ironing easier. Simply select the Steam Fresh™ cycle or you can add a Steam option to selected cycles.

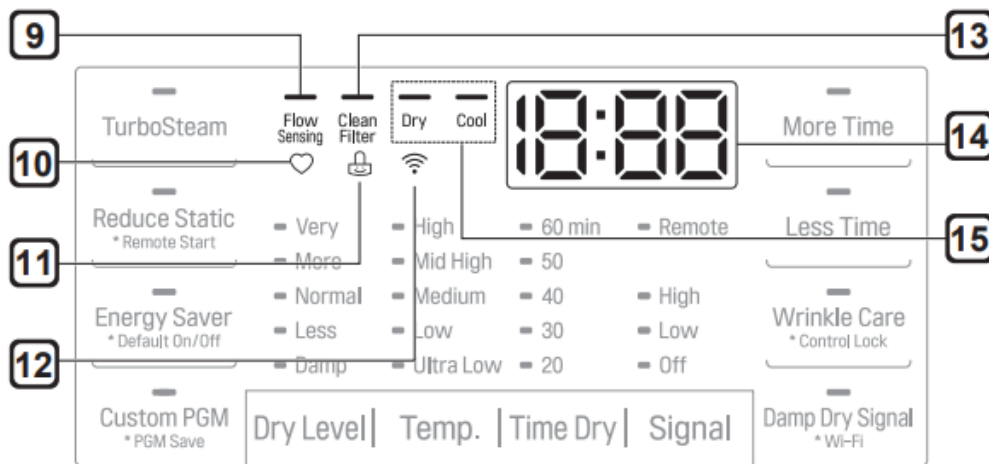

9. Flow Sense™ Duct Blockage Sensing System Indicator: The Flow Sense™ duct blockage sensing system detects and alerts you to blockages in the ductwork that reduce exhaust flow from the dryer. Maintaining a clean exhaust system improves operating efficiency and helps minimize service calls, saving you money.

10. Custom PGM: If you have a special combination of settings that you use frequently, you can save these settings as a Custom Program.

11. Control Lock Indicator: When Control Lock is set, the Control Lock indicator appears and all buttons are disabled except the POWER button. This prevents children from changing settings while the dryer is operating.

12. Wi-Fi Indicator: When the appliance is connected to the Internet through a home Wi-Fi network, this indicator appears.

13. Check Filter Reminder: The display will show Check Filter when the dryer is turned on as a reminder to check the filter. It turns off when the START/PAUSE button is pressed.



14. Estimated Time Remaining: This display shows the estimated time remaining for Sensor Dry cycles or the actual time remaining for Time Dry or Manual Dry cycles.

NOTE: The cycle time on Sensor Dry cycles may fluctuate as the dryer recalculates drying time for optimal results.

15. Cycle Completion Indicator with Clean Filter Reminder: This portion of the display shows which stage of the drying cycle is currently underway (Check Filter, Drying, Cooling).

Cycle Guide

Sensor Dry Cycles

- Sensor Dry cycles utilize LG's unique dual sensor system to detect and compare the moisture level in clothes and in the air and adjust the drying time as needed to ensure superior results. The dryer automatically sets the dryness level and temperature at the recommended setting for each cycle. The estimated time remaining will be shown in the display.

NOTE: To protect your garments not every dryness level, temperature, or option is available with every cycle. See the Cycle Guide for details.

Manual Dry Cycles

- Use Manual Dry cycles to select a specific amount of drying time and a drying temperature. When a Manual Dry cycle is selected, the Estimated Time Remaining display shows the actual time remaining in your cycle. You can change the actual time in the cycle by pressing the More Time or Less Time buttons.

NOTE: The Energy Saver option is turned on by default in the Normal Cycle. Turn off the Energy Saver option for a faster Normal cycle which begins with heated drying. To turn the Energy Saver default off, press and hold the Energy Saver button. ON or OFF appears in the display.

NSF Certification

NSF International (formerly the National Sanitation Foundation), certifies that the ANTI BACTERIAL cycle reduces 99.9% of bacteria on laundry, and none of the bacteria will carry over onto the next laundry load.

- The default settings for the ANTI BACTERIAL cycle are High temperature and Very Dry. These default settings cannot be changed.
- Do NOT use this cycle with delicate items or fabrics.



**Protocol P154 Sanitization
Performance of Residential
Clothes dryer**

(DLE3500*, DLG3501*, DLEX3700*, DLGX3701*, DLEX3900*, DLGX3901*)

Non-Steam Models (DLE3500*, DLG3501*)

☐ = default setting
● = allowable option
* = Energy Saver

Cycle	Fabric Type	Dry Level	Temp.	Time in Min.	Wrinkle Care	Damp Dry Signal	Anti Bacterial
SENSOR DRY							
Normal*	Work clothes, corduroys, etc.	Normal	Mid High	Elec: 57 Gas: 63	●	●	●
		Adj.					
Heavy Duty	Jeans, heavyweight items	Normal	High	54	●	●	●
		Adj.					
Bedding	Comforters, Pillows, Shirts	Normal	Medium	55			
		Adj.					
Towels	Denims, towels, heavy cottons	Normal	Medium	55	●	●	●
		Adj.					
Small Load	Only normal & cotton/towels fabric type (Max. 3lb)	Normal	High	30	●		
		Adj.					
Perm. Press	Permanent press, synthetic items	Normal	Medium	32	●	●	
		Adj.					
Delicates	Lingerie, sheets, blouses	Normal	Low	28	●	●	
		Adj.					
MANUAL DRY							
Speed Dry	For small loads with short drying times	Off	High	25	●		
			Adj.	Adj.			
Air Dry	For items that require heat-free drying such as plastics or rubber	Off	No Heat	30	●		
				Adj.			

Cycle Modifier Buttons

Sensor Dry cycles have preset settings that are selected automatically. Manual Dry cycles have default settings, but you may also customize the settings using the cycle modifier buttons. Press the button for that option to view and select other settings.

Dry Level



Use this button to select the level of dryness for the cycle. Press the Dry Level button repeatedly to scroll through available settings.

- This option is only available with Sensor Dry cycles.
- The dryer will automatically adjust the cycle time. Selecting More Dry or Very Dry will increase the cycle time, while Less Dry or Damp Dry will decrease the cycle time.
- Use a Less Dry or Damp Dry setting for items that you wish to iron.

Temp.

Use this button to adjust the temperature setting. This allows precise care of fabrics and garments. Press the Temp. button repeatedly to scroll through available settings.

Time Dry

- Use this button to manually select the drying time, from 20 to 60 minutes, in 10-minute increments. Use this for small loads or to remove wrinkles. Use the More Time/Less Time buttons to add or reduce the drying time in 1-minute increments.

Signal

- Use this button to adjust the volume of the Signal or turn off the Signal. Press the button repeatedly until the desired volume setting is illuminated.

Option Buttons

The dryer features several additional cycle options to customize cycles to meet individual needs. Certain option buttons also feature a special function that can be activated by pressing and holding that option button for 3 seconds.

Adding Cycle Options to a Cycle

1. Turn on the dryer and turn the Cycle selector knob to select the desired cycle.
2. Use the cycle modifier buttons to adjust the settings for that cycle.
3. Press the cycle option button(s) to add the desired options. A confirmation message is shown in the display.
4. Press the Start/Pause button to start the cycle. The dryer starts automatically.

Wrinkle Care

- Selecting this option will tumble the load periodically for up to 3 hours after the selected cycle, or until the door is opened. This is helpful in preventing wrinkles when you are unable to remove items from the dryer immediately.

Damp Dry Signal

- When this option is selected, the dryer signals when the load is approximately 80% dry. This allows you to remove faster-drying lightweight items or items that you would like to iron or hang while they are still slightly damp.

Energy Saver

- This option helps to reduce the energy consumption of the Normal Cycle, depending on the load size. When the Energy Saver option is selected, the cycle begins with an air dry section and the drying time is increased.

Special Functions

Some cycle option buttons also activate secondary functions. These special functions are marked with an asterisk (*). Press and hold the option button marked with the special function to activate it.

Control Lock

Use this option to prevent unwanted use of the dryer or to keep cycle settings from being changed while the dryer is operating.

Activating the Control Lock Function

- Press and hold the Wrinkle Care button for 3 seconds.
- The Control Lock icon will be shown in the display, and all controls will be disabled except the Power button.

Deactivating the Control Lock Function

- Press and hold the Wrinkle Care button for 3 seconds.
- Once set, Control Lock remains active until it is manually deactivated. Control Lock must be turned off to run another cycle.

Custom PGM

Save special combinations of settings that are used frequently as a custom program.

Saving a Custom Program

1. Turn on the dryer and select the desired settings using the cycle selector knob and cycle modifier or option buttons.
2. Press and hold the Custom PGM button for three seconds.

Recalling a Custom Program

1. Turn on the dryer and press the Custom PGM button.
2. Press the Start/Pause button to start the cycle.

Default On/Off

- This option allows the Energy Saver settings to be changed. To run a Normal cycle without the Energy Saver option, press and hold the Energy Saver button for three seconds. ON or OFF appears in the display

Using the Steam Functions

- LG's new steam technology injects fabrics with a swirling jet of hot steam to refresh clothes, reduce static, and make ironing easier.
- Simply select the Steam Fresh™ cycle, or add a steam option to selected cycles.

The Steam Sanitary™ Cycle

- The Steam Sanitary™ cycle is ideal for sanitizing non-washable items quickly and easily using the power of steam.
- Use this cycle for cotton and polyester material. (Do NOT use for urethane foam, down feathers or delicate items).

The Steam Fresh™ Cycle

- Steam Fresh™ uses the power of steam to quickly reduce wrinkles and odors in fabrics. It brings new life to wrinkled clothes that have been stored for an extended time and makes heavily wrinkled clothes easier to iron. Steam Fresh™ can also be used to help reduce odors in fabrics.

Using the Steam Fresh™ Cycle

1. Turn on the dryer and turn the cycle selector knob to select the Steam Fresh™ cycle.
2. To add an option function, select Reduce Static, or Wrinkle Care.
3. The display shows the load size (number of items). Change the steam time by pressing the More Time or Less Time buttons to fit the size of the load.
4. Press Start/Pause to start the cycle.

The Steam Options

- The Reduce Static option injects steam late in the drying cycle to reduce the static electricity caused by dry fabrics rubbing together.

Adding Steam to a Standard Cycle

1. Turn on the dryer and turn the cycle selector knob to select the desired cycle.
2. Use the cycle setting buttons to adjust the settings for that cycle.
3. Press the Steam option button (Reduce Static, or Wrinkle Care) for the desired steam option. Then adjust for the load size using the More Time or Less Time buttons.
4. Press Start/Pause to start the cycle.

	STEAM	DEFAULT TIME	TEMP.	DRY LEVEL	FABRIC STATE	FABRIC TYPE	MAXIMUM AMOUNT
STEAM SANITARY™		39 minutes			Dry	Comforter Bedding	Single (1 each)
						Children's clothing	3 lbs.
STEAM FRESH™		20 minutes	•		Dry	Comforter	Single (1 each)
						Shirts*	5 each
	REDUCE STATIC	10 minutes			Dry	Shirts*	8 lbs. (18 Items.)
STEAM OPTION	REDUCE STATIC	FOLLOWS SELECTED CYCLE		•	Wet	Varies by selected cycle	8 lbs. (18 Items.)
	+Turbo Steam	FOLLOWS SELECTED		•	Wet	Varies by selected cycle	8 lbs. (18 Items.)
TIME DRY	REDUCE STATIC	45 minutes	•		Wet	Varies by selected cycle	8 lbs. (18 Items.)



•* Shirt: 70% cotton, 30% poly blend. Except especially delicate fabrics

SMART FUNCTIONS

LG SmartThinQ Application

The LG SmartThinQ application allows you to communicate with the appliance using a smartphone.

Before Using LG SmartThinQ

For appliances with the  or  logo

1. Use a smartphone to check the strength of the wireless router (Wi-Fi network) near the appliance.
 - If the distance between the appliance and the wireless router is too far, the signal strength becomes weak. It may take a long time to register or installation may fail.
2. Turn off the Mobile data or Cellular Data on your smartphone.



3. Connect your smartphone to the wireless router.



NOTE



- To verify the Wi-Fi connection, check that Wi-Fi  icon on the control panel is lit.
- The appliance supports 2.4 GHz Wi-Fi networks only. To check your network frequency, contact your Internet service provider or refer to your wireless router manual.
- LG SmartThinQ is not responsible for any network connection problems or any faults, malfunctions, or errors caused by network connection.
- The surrounding wireless environment can make the wireless network service run slowly
- If the appliance is having trouble connecting to the Wi-Fi network, it may be too far from the router. Purchase a Wi-Fi repeater (range extender) to improve the Wi-Fi signal strength.
- The network connection may not work properly depending on the Internet service provider.
- The Wi-Fi connection may not connect or may be interrupted because of the home network environment.
- If the appliance cannot be registered due to problems with the wireless signal transmission, unplug the appliance and wait about a minute before trying again.
- If the firewall on your wireless router is enabled, disable the firewall or add an exception to it.
- The wireless network name (SSID) should be a combination of English letters and numbers. (Do not use special characters.)
- Smartphone user interface (UI) may vary depending on the mobile operating system (OS) and the manufacturer.
- If the security protocol of the router is set to WEP, network setup may fail. Change the security protocol (WPA2 is recommended), and register the product again.

Installing the LG SmartThinQ Application

- Search for the LG SmartThinQ application from the Google Play Store or Apple App Store on a smart phone. Follow instructions to download and install the application.

NOTE: If you choose the simple login to access the LG SmartThinQ application, you must go through the appliance registration process each time you change your smartphone or reinstall the application.

LG SmartThinQ Application Features

For appliances with the  or  logo

Dryer Cycle

- Download new and special cycles that are not included in the basic cycles on the appliance.
- Appliances that have been successfully registered can download a variety of specialty cycles specific to the appliance.
- Only one cycle can be stored on the appliance at a time.
- Once cycle download is completed in the appliance, the appliance keeps the downloaded cycle until a new cycle is downloaded.

Venting Tips

- Provides venting tips.

Energy Monitoring

- This feature keeps track of the refrigerator's power consumption and the number of door openings.

Remote Control

- Control the Refrigerator Temperature, Fresh Air Filter and Ice Plus from the smart phone app.

Push Messages

- If the door remains open for more than ten minutes, you will receive a push message. When Ice Plus is finished, you will receive a push message.

Smart Diagnosis™

- This function provides useful information for diagnosing and solving issues with the appliance based on the pattern of use.

Settings

- Allows you to set various options on the refrigerator and in the application.

NOTE

- If you change your wireless router, your Internet service provider or your password after registering the appliance, delete it from the LG SmartThinQ Settings → Edit Product and register again.
- This information is current at the time of publication. The application is subject to change for product improvement purposes without notice to users.
- NFC function would vary depending on smart phones.

Wireless LAN Module Specifications

Model	LCW-004
Frequency Range	2412 to 2462 MHz
Output Power (Max)	IEEE 802.11 b: 22.44 dBm
	IEEE 802.11 g: 24.68 dBm
	IEEE 802.11 n: 24.11 dBm

FCC Notice

This equipment has been tested and found to comply with the limits for a Class B digital device, pursuant to Part 15 of the FCC Rules. These limits are designed to provide reasonable protection against harmful interference in a residential installation. This equipment generates, uses, and can radiate radio frequency energy and, if not installed and used in accordance with the instructions, may cause harmful interference to radio communications. However, there is no guarantee that interference will not occur in a particular installation. If this equipment does cause harmful interference to radio or television reception, which can be determined by turning the equipment off and on, the user is encouraged to try to correct the interference by one or more of the following measures:

- Reorient or relocate the receiving antenna.
- Increase the separation between the equipment and the receiver.
- Connect the equipment to an outlet on a circuit different from that to which the receiver is connected.
- Consult the dealer or an experienced radio/TV technician for help.

This device complies with part 15 of the FCC Rules. Operation is subject to the following two conditions:

- 1) this device may not cause harmful interference and
- 2) this device must accept any interference received, including interference that may cause undesired operation of the device.

Any changes or modifications in construction of this device which are not expressly approved by the party responsible for compliance could void the user's authority to operate the equipment.

FCC RF Radiation Exposure Statement

- This equipment complies with FCC radiation exposure limits set forth for an uncontrolled environment. This transmitter must not be co-located or operating in conjunction with any other antenna or transmitter.

- This equipment should be installed and operated with a minimum distance of 20 cm (7.8 inches) between the antenna and your body. Users must follow the specific operating instructions for satisfying RF exposure compliance.



Open Source Software Notice Information

- To obtain the source code under GPL, LGPL, MPL, and other open source licenses, that is contained in this product, please visit <http://opensource.lge.com>. In addition to the source code, all referred license terms, warranty disclaimers and copyright notices are available for download.
- LG Electronics will also provide open source code to you on CD-ROM for a charge covering the cost of performing such distribution (such as the cost of media, shipping, and handling) upon email request to opensource@lge.com. This offer is valid for three (3) years from the date on which you purchased the product.

Smart Diagnosis™ Function

Should you experience any problems with the appliance, it has the capability of transmitting data via your telephone to the LG Customer Information Center. NFC or Wi-Fi equipped models can also transmit data to a smartphone using the LG SmartThinQ application.



Smart Diagnosis™ through the Customer Information Center

For appliances with the  or  logo

This method allows you to speak directly to our trained specialists. The specialist records the data transmitted from the appliance and uses it to analyze the issue, providing a fast and effective diagnosis.

1. Call the LG Electronics Customer Information Center at: (LG U.S.A.) 1-800-243-0000 (LG Canada) 1-888-542-2623
2. When instructed to do so by the call center, place the mouthpiece of the phone close to the Smart Diagnosis™ icon. Do not press any other buttons.
3. Press and hold the Temp. button for 3 seconds.
4. Keep the phone in place until the tone transmission has finished.
5. Once the countdown is over and the tones have stopped, resume your conversation with the call center agent, who will then be able to assist you using the information transmitted for analysis.

SmartThinQ Smart Diagnosis™

For appliances with the  or  logo

- Use the Smart Diagnosis feature in the SmartThinQ application for help diagnosing issues with the appliance without the assistance of the LG Customer Information Center.

- Follow the instructions in the SmartThinQ application to perform a Smart Diagnosis using your smartphone

MAINTENANCE

Regular Cleaning

WARNING: To reduce the risk of fire, electric shock, injury to persons, or death when using this appliance, follow basic precautions, including the following:

- Unplug the dryer before cleaning.
- Never use harsh chemicals, abrasive cleaners, or solvents to clean the washer. They will damage the finish.

Cleaning the Exterior

Proper care of your dryer can extend its life. The outside of the machine can be cleaned with warm water and a mild, nonabrasive household detergent. Immediately wipe off any spills with a soft, damp cloth.

NOTE

- Do not use methylated spirits, solvents, or similar products.
- Never use steel wool or abrasive cleansers; they can damage the surface.

Cleaning the Interior

- Wipe around the door opening and seal with a soft, damp cloth to prevent lint and dust buildup that could damage the door seal.
- Clean the window with a soft cloth dampened with warm water and a mild, nonabrasive household detergent, then wipe dry.
- The stainless steel drum can be cleaned with a conventional stainless steel cleaner, used according to the manufacturer's specifications. Never use steel wool or abrasive cleansers; they may scratch or damage the surface.

Cleaning Around and Under the Dryer

- Vacuum lint and dust from around the dryer and underneath it regularly. Vent ductwork should be checked for lint buildup and cleaned at least once per year. If any noticeable reduction in airflow or drying performance occurs, immediately check ductwork for obstructions and blockages.

Maintaining Ductwork

- Vent ductwork should be checked for lint buildup once per month and cleaned at least once per year. If any noticeable reduction in airflow or drying performance occurs,

immediately check ductwork for obstructions and blockages. Contact a qualified technician or service provider.

Cleaning the Lint Filter

Always clean the lint from the filter after every cycle.

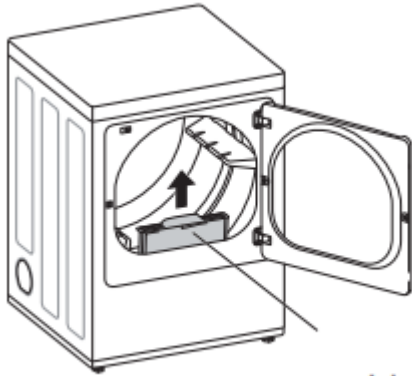

Lint Filter

To clean the lint filter, open the dryer door and pull the lint filter straight up. Then:

1. For everyday cleaning, roll any lint off the filter with your fingers, or

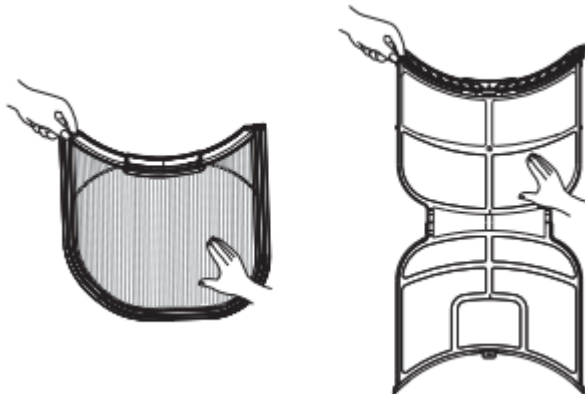

2. Vacuum the lint filter.

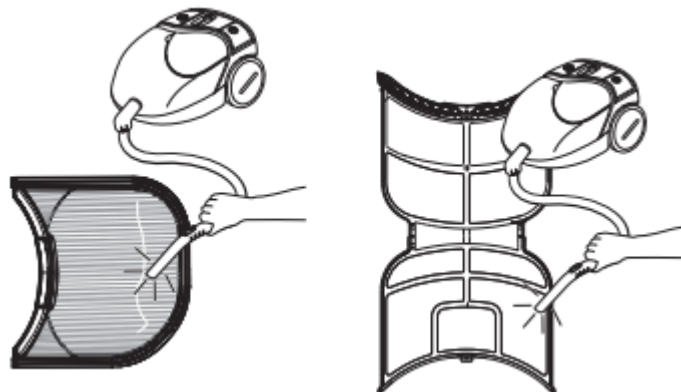

3. If the lint filter has become very dirty or clogged with fabric softener, wash the lint filter in warm, soapy water and allow it to dry thoroughly before reinstalling.

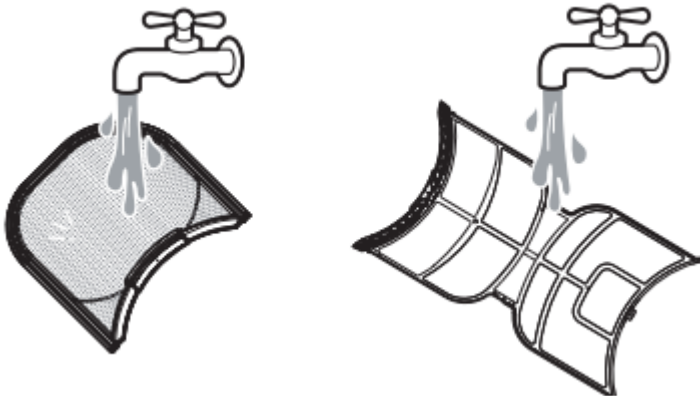

NOTE: NEVER operate the dryer without the lint filter in place.

TROUBLESHOOTING

FAQs: Frequently Asked Questions

Q: When I press a button, why does my dryer beep and then nothing happens?

A: The Control Lock feature is turned on. To turn off Control Lock, turn the dryer on, then press and hold the button that has *Control Lock on or under it for 3 seconds.

Q: Why does my dryer take so long to dry clothes?

A: Proper airflow is critical to the efficient operation of clothes dryers. A lint filter which is full of lint or clogged with fabric softener sheet residue can reduce the airflow to the point that the time required to dry clothing will be greatly increased. Another factor affecting dry time is your home exhaust system. An exhaust system which is dirty and clogged with lint, or is excessively long, needs to be professionally cleaned or repaired.

Q: Why does my dryer start by itself every few minutes?

A: This is how the Wrinkle Care feature works. The dryer runs briefly every few minutes for up to 3 hours after the cycle finishes. This feature is designed to help prevent wrinkles from setting in when the dryer is not unloaded immediately after the cycle is finished.

Q: Why does my dryer show 3 minutes when I select the Steam Fresh™ cycle?

A: When the Steam Fresh™ cycle is selected, the dryer displays the recommended number of garments for the cycle, not the estimated cycle time, until the cycle is started. Use the More Time or Less Time buttons to adjust the load size setting for the number of garments you desire. For a large load or single bulky item use the **b: 9** (big) setting.

User Support Videos

For further assistance, there are videos and tutorials available through the LG.com website.

1. On the lg.com/us home page, click on the Support menu tab to bring up the menu selections. Select Video Tutorials.
2. Type Dryer in the search box on the new page and click the Search button



Scan this QR code to quickly access the video search page on the LG website. Once there, type Dryer in the search box.

Before Calling for Service

This dryer is equipped with an automatic error-monitoring system to detect and diagnose problems at an early stage. If the dryer does not function properly or does not function at all, check the following before you call for service.

Operation

Problem	Possible Cause	Solutions
<p>The Flow Sense™ indicator remains active after clearing the restriction in the venting.</p>	<p>After clearing the restriction, the Flow Sense™ system requires multiple, consecutive cycles to determine that the performance value has improved before the Flow Sense™ indicator is reset.</p>	<ul style="list-style-type: none"> • If the Flow Sense™ indicator remains active for more than five cycles after the restriction has been cleared, call for service.
<p>Dryer will not turn on</p>	<p>Power cord is not properly plugged in.</p>	<ul style="list-style-type: none"> • Make sure that the plug is securely plugged into a grounded outlet matching the dryer's rating plate.
	<p>House fuse is blown, circuit breaker has tripped, or power outage has occurred.</p>	<ul style="list-style-type: none"> • Reset circuit breaker or replace fuse. Do not increase fuse capacity. If the problem is a circuit overload, have it corrected by a qualified electrician.
<p>Dryer does not heat</p>	<p>House fuse is blown, circuit breaker has tripped, or power outage has occurred.</p>	<ul style="list-style-type: none"> • Reset circuit breaker or replace fuse. Do not increase fuse capacity. If the problem is a circuit overload, have it corrected by a qualified electrician. • NOTE: Due to the design of electric dryers, it is possible for a circuit problem to allow an electric dryer to run without heat.
	<p>Gas supply or service is turned off.</p>	<ul style="list-style-type: none"> • Confirm that the house gas shutoff and the dryer gas shutoff valves are both fully open. Even if gas is not supplied to the dryer, it will run and no error codes will display. Verify that other gas appliances in the home are working normally.
	<p>ENERGY SAVER option selected (on some models)</p>	<ul style="list-style-type: none"> • If using the Normal cycle, deselect the ENERGY SAVER option. The Energy Saver option is selected by default. This option reduces energy



		<p>use by adding an air dry section to the beginning of the cycle. It is normal to feel no heat at the beginning of the cycle while in ENERGY SAVER mode.</p>
<p>Clothes take too long to dry</p>	<p>Exhaust ducts are blocked, dirty, or duct run is too long.</p>	<ul style="list-style-type: none"> • Confirm that the exhaust duct is properly configured and free of debris, lint, and obstructions. Make sure that outside wall dampers can open properly and are not blocked, jammed, or damaged.
	<p>Load is not properly sorted.</p>	<ul style="list-style-type: none"> • Separate heavy items from lightweight items. Larger and heavier items take longer to dry. Light items in a load with heavy items can fool the sensor because the light items dry faster.
<p>Clothes take too long to dry</p>	<p>Large load of heavy fabrics.</p>	<ul style="list-style-type: none"> • Heavy fabrics take longer to dry because they tend to retain more moisture. To help reduce and maintain more consistent drying times for large and heavy fabrics, separate these items into smaller loads of a consistent size.
	<p>Dryer controls are not set properly.</p>	<ul style="list-style-type: none"> • Use the appropriate control settings for the type of load you are drying. Some loads may require an adjustment of the dry level setting for proper drying.
	<p>Lint filter needs to be cleaned.</p>	<ul style="list-style-type: none"> • Remove the lint from the filter before every load. With the lint removed, hold the filter up to a light to see if it is dirty or clogged. With some loads that produce high amounts of lint, such as new bath towels, it may be necessary to pause the cycle and clean the filter during the cycle.



	<p>House fuse is blown, circuit breaker has tripped, or power outage has occurred.</p>	<ul style="list-style-type: none"> • Reset circuit breaker or replace fuse. Do not increase fuse capacity. If the problem is a circuit overload, have it corrected by a qualified electrician. • NOTE: Due to the design of electric dryers, it is possible for a circuit problem to allow an electric dryer to run without heat.
	<p>Dryer is overloaded.</p>	<ul style="list-style-type: none"> • Divide extra large loads into smaller loads for better drying performance and efficiency.
	<p>Dryer is underloaded.</p>	<ul style="list-style-type: none"> • If you are drying a very small load, add a few extra items to ensure proper tumbling action. If the load is very small and you are using SENSOR DRY cycles, the electronic control cannot properly sense the dryness of the load and may shut off too soon. Use TIME DRY or add some extra wet clothes to the load.
	<p>ENERGY SAVER option selected (on some models)</p>	<ul style="list-style-type: none"> • If using the Normal cycle, deselect the ENERGY SAVER option. This option reduces energy use by adding an air dry section to the beginning of the cycle.
<p>Drying time is not consistent</p>	<p>Heat settings, load size, or dampness of clothing is not consistent.</p>	<ul style="list-style-type: none"> • The drying time for a load will vary depending on the type of heat used (electric, natural gas, or LP gas), the size of the load, the type of fabrics, the wetness of the clothes, and the condition of the exhaust duct and lint filter. Even an unbalanced load in the washer can cause poor spinning, resulting in wetter clothes which will take longer to dry.

Performance



Problem	Possible Cause	Solutions
Greasy or dirty spots on clothes	Fabric softener used incorrectly.	<ul style="list-style-type: none"> • Confirm and follow the instructions provided with your fabric softener.
	Clean and dirty clothes are being dried together.	<ul style="list-style-type: none"> • Use your dryer to dry only clean items. Soil from dirty clothes can transfer to the clean clothes in the same or later loads.
	Clothes were not properly cleaned or rinsed before being placed in the dryer.	<ul style="list-style-type: none"> • Stains on dried clothes could be stains that were not removed during the washing process. Make sure that clothes are being completely cleaned or rinsed according to the instructions for your washer and detergent. Some difficult soils may require pre-treating prior to washing.
Clothes are wrinkled	Clothes dried too long (over dried).	<ul style="list-style-type: none"> • Over drying a load of laundry can lead to wrinkled clothes. Try a shorter drying time or LESS DRY setting and remove items while they still retain a slight amount of moisture.
	Clothes left in dryer too long after cycle ends.	<ul style="list-style-type: none"> • Use the WRINKLE CARE option. This feature will tumble the clothes briefly every few minutes for up to 3 hours to help prevent wrinkling.
Clothes are shrinking	Garment care instructions are not being followed.	<ul style="list-style-type: none"> • To avoid shrinking your clothes, always consult and follow fabric care instructions. Some fabrics will naturally shrink when washed. Other fabrics can be washed but will shrink when dried in a dryer. Use a low or no heat setting.

Lint on clothes	Lint filter not cleaned properly.	<ul style="list-style-type: none"> Remove the lint from the filter before every load. With the lint removed, hold the filter up to a light to see if it is dirty or clogged. If it looks dirty, follow the cleaning instructions. With some loads that produce high amounts of lint, it may be necessary to clean the filter during the cycle.
	Laundry not sorted properly.	<ul style="list-style-type: none"> Some fabrics are lint producers (i.e., a fuzzy white cotton towel) and should be dried separately from clothes that are lint trappers (i.e., a pair of black linen pants).
	Excess static in clothes.	<ul style="list-style-type: none"> Use a fabric softener to reduce static electricity. Be sure to follow the manufacturer's instructions. Overdrying a load of laundry can cause a buildup of static electricity. Adjust settings and use a shorter drying time, or use SENSOR DRY cycles.
	Dryer is overloaded.	<ul style="list-style-type: none"> Divide extra large loads into smaller loads for drying.
	Tissue, paper, etc., left in pockets.	<ul style="list-style-type: none"> Check pockets thoroughly before washing and drying clothes.
Excess static in clothes after drying	Fabric softener is not used or used incorrectly.	<ul style="list-style-type: none"> Use a fabric softener or the REDUCE STATIC option, if equipped, to reduce static electricity. Be sure to follow the manufacturer's instructions.
	Clothes dried too long (overdried).	<ul style="list-style-type: none"> Overdrying a load of laundry can cause a buildup of static electricity. Adjust settings and use a shorter drying time, or use MANUAL DRY cycles. Select a LESS DRY setting



		on SENSOR DRY cycles, if necessary.
	Drying synthetics, permanent press, or synthetic blends.	<ul style="list-style-type: none"> • These fabrics are naturally more prone to static buildup. Try using fabric softener, or use LESS DRY and/or shorter TIME DRY time settings.
Clothes have damp spots after a Sensor Dry cycle.	Very large load or very small load. Single large item such as a blanket or comforter.	<ul style="list-style-type: none"> • If items are too tightly packed or too sparse the sensor may have trouble reading the dryness level of the load. Use a TIME DRY cycle for very small loads. • Large, bulky items such as blankets or comforters can sometimes wrap themselves into a tight ball of fabric. The outside layers will dry and register on the sensors, while the inner core remains damp. When drying a single bulky item, it may help to pause the cycle once or twice and rearrange the item to unwrap and expose any damp areas. • To dry a few remaining damp items from a very large load or a few damp spots on a large item after a sensor cycle has completed, empty the lint trap, then set a TIME DRY cycle to finish drying the item(s).
Trouble connecting appliance and smartphone to WiFi network	The password for the WiFi network was entered incorrectly.	<ul style="list-style-type: none"> • Delete your home Wi-Fi network and begin the registration process again.
	Mobile data for your smartphone is turned on.	<ul style="list-style-type: none"> • Turn off the Mobile data on your smartphone before registering the appliance.
		<ul style="list-style-type: none"> • The wireless network name (SSID) should be a combination of English

	<p>The wireless network name (SSID) is set incorrectly.</p>	<p>letters and numbers. (Do not use special characters.)</p>
	<p>The router frequency is not 2.4 GHz.</p>	<ul style="list-style-type: none"> • Only a 2.4 GHz router frequency is supported. Set the wireless router to 2.4 GHz and connect the appliance to the wireless router. To check the router frequency, check with your Internet service provider or the router manufacturer.
	<p>The distance between the appliance and the router is too far.</p>	<ul style="list-style-type: none"> • If the appliance is too far from the router, the signal may be weak and the connection may not be configured correctly. Move the router closer to the appliance or purchase and install a Wi-Fi repeater.

Steam Functions (Steam Models)



Problem	Possible Cause	Solutions
Water drips from nozzle when STEAM CYCLE starts	This is normal.	<ul style="list-style-type: none"> • This is steam condensation. The dripping water will stop after a short time.
Garments still wrinkled after Steam Fresh™	Too many or overly different types of garments in dryer.	<ul style="list-style-type: none"> • Small loads of 1 to 5 items work best. Load fewer garments. Load similar types of garments.
Creases or pleats are gone from garments after Steam Fresh™	The function of this cycle is to remove wrinkles from fabric.	<ul style="list-style-type: none"> • Use an iron to replace creases and pleats in garments.
Garments have static after using the Reduce Static option	This is normal.	<ul style="list-style-type: none"> • The amount of static experienced will depend on the individual moisture level in the skin.
Garments are too damp or too dry after using the Reduce Static option	Correct drying options not selected.	<ul style="list-style-type: none"> • Select the load weight manually before starting the Reduce Static option.
Steam does not generate, but no error code is shown	Water level error.	<ul style="list-style-type: none"> • Unplug dryer and call for service.
Water drips from door during STEAM CYCLE	This is normal.	<ul style="list-style-type: none"> • Condensation will normally form on the inside of the dryer door during steam operation. Some condensation may drip out the bottom of the door.

<p>Steam is not visible during STEAM CYCLE</p>	<p>This is normal.</p>	<ul style="list-style-type: none"> • Steam vapor is difficult to see when the door is closed. However, condensation will normally form on the inside of the dryer door if the steam system is operating normally.
<p>Drum does not turn during STEAM CYCLE</p>	<p>This is normal.</p>	<ul style="list-style-type: none"> • The drum is turned off so that the steam vapor remains in the drum. The drum will normally turn for about 2 seconds once a minute.
<p>Cannot see steam vapor at the beginning of cycle</p>	<p>This is normal.</p>	<ul style="list-style-type: none"> • Steam is released at different stages of the cycle for each option.
<p>Odors remain in clothing after Steam Fresh™</p>	<p>Steam Fresh™ did not remove odor completely.</p>	<ul style="list-style-type: none"> • Fabrics containing strong odors should be washed in a normal cycle.

Error Codes



Problem	Possible Cause	Solutions
Error code: tE1 through tE7	Temperature sensor failure.	<ul style="list-style-type: none"> • Turn off the dryer and call for service.
Display shows error code: PS	Power cord is connected incorrectly.	<ul style="list-style-type: none"> • Check the connection of the power cord to the terminal block.
<p>*Flow Sense™ indicator shows four bars during the drying cycle or the display shows "d80" after drying</p> <p>* This warning light is not a dryer failure and is not covered by the dryer warranty. Contact a duct cleaning service to set up an appointment to have your exhaust system cleaned and inspected.</p>	Exhaust system is too long or has too many turns/restrictions.	<ul style="list-style-type: none"> • Install a shorter or straighter duct run. See the Installation Instructions for details.
	Partial blockage of the ductwork due to lint buildup or other foreign object.	<ul style="list-style-type: none"> • Ductwork should be checked/cleaned immediately. Dryer can be used in this condition, but drying times will be longer and energy consumption will increase.
	The appliance has detected a restriction in the external dryer venting.	<ul style="list-style-type: none"> • If exhaust restrictions are sensed by the Flow Sense™ system, the indicator will remain on for 2 hours after the end of the cycle. Opening the door or pressing the Power button will turn off the display.
The Flow Sense™ indicator remains active after clearing the restriction in the venting.	After clearing the restriction, the Flow Sense™ system requires multiple, consecutive cycles to determine that the performance value has improved before the Flow Sense™ indicator is reset.	<ul style="list-style-type: none"> • If the Flow Sense™ indicator remains active for more than five cycles after the restriction has been cleared, call for service.



<p>The display shows big</p>	<p>More Time button was pressed.</p>	<ul style="list-style-type: none"> • This display indicates that the steam option has been set for a “big” item such as a comforter. <p>Press the LESS TIME button to reduce the indicated load size.</p>
<p>The display shows</p> 	<p>The duct work is about 75% - 95% blocked. (“d75”, “d80”, “d90” or “d95” error code is displayed for 2 hours only)</p>	<ul style="list-style-type: none"> • Do not use the dryer until the exhaust system has been cleaned and/or repaired. Using the dryer with a severely restricted exhaust is dangerous and could result in a fire or other property damage. <p>Check the outside dryer vent while the dryer is operating to make sure there is strong airflow.</p> <p>If the exhaust system is extremely long, have it repaired or rerouted.</p>
	<p>House exhaust system blocked.</p>	<ul style="list-style-type: none"> • Keep the area around the dryer clean and free of clutter. <p>Check vent hood for damage or lint clogging. Make sure the area around the vent hood is clear.</p>
<p>Check filter indicator is on during the drying cycle</p>	<p>Lint filter not cleaned properly.</p>	<ul style="list-style-type: none"> • Remove the lint from the filter before every load. With the lint removed, hold the filter up to a light to see if it is dirty or clogged. If it looks dirty, follow the cleaning instructions. With some loads that produce high amounts of lint, it may be necessary to clean the filter during the cycle.



Warning

This content is compiled from multiple sources and is provided for reference purposes only. It may not be complete or fully applicable to all situations. If you are unable to resolve your issue, please contact the product manufacturer or an authorized service provider for official support.

Document generated by [ManualsFile](#)