

APPLIANCE FEATURES

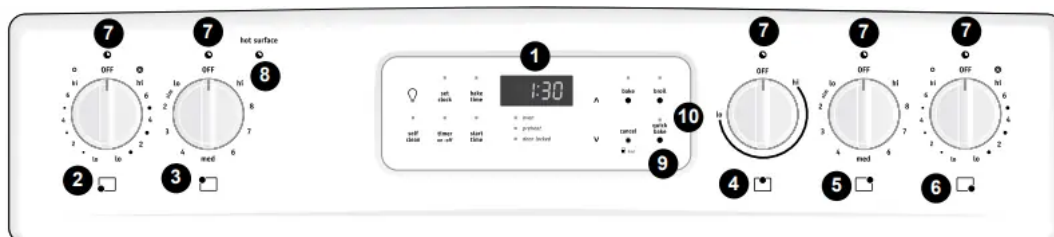

Your electric range features include:

1. Electronic oven control with kitchen timer.
2. Left front single (some models), dual (some models) or triple (some models) radiant element control.
3. Left rear single (some models) or dual (some models) radiant control.
4. Keep Warm zone radiant element control (some models).
5. Right rear single (some models) or dual (some models) radiant element control.
6. Right front single (some models), dual (some models) or triple (some models) radiant control.
7. Element ON indicator light(s).
8. HOT SURFACE indicator light(s).
9. Quick Bake cooking system pad (some models).
10. Quick Bake cooking system indicator light (some models).
11. Oven interior light with removable cover.
12. Automatic oven door light switch (some models).
13. Self-cleaning oven interior.
14. Self-clean door latch.
15. Quick Bake cooking system fan (some models).
16. Adjustable interior oven rack(s). Effortless Oven Rack™ system (not shown-some models).
17. Large 1-piece oven door handle.
18. Full width oven door with window.
19. Storage drawer with large 1-piece door handle (some models) or lower cover panel (some models).
20. Easy to clean upswept cooktop.
21. Ceramic smoothtop (elements, styles and color will vary by model).

- 22. 6" single radiant element (some models).
- 23. 5-7" dual radiant element (some models).
- 24. 9" single radiant element (some models).
- 25. 6-9" dual radiant element (some models).
- 26. 12" single radiant element (some models).
- 27. Keep Warm zone radiant element (some models).
- 28. Broil pan (some models).
- 29. Broil pan insert (some models).
- 30. Leveling legs and **anti-tip** bracket (included).

The features shown for your appliance may vary according to model type & color.

Be sure to visit us online at www.frigidaire.com for a complete line of accessories.



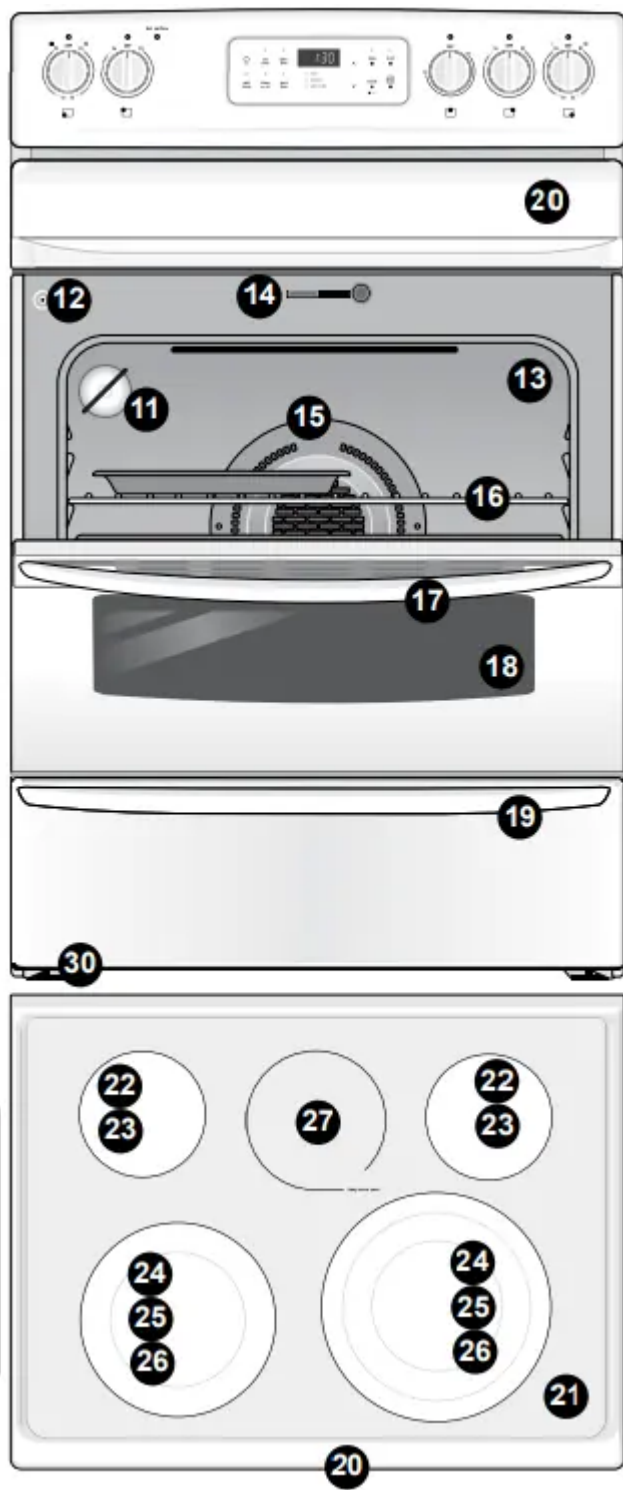



BEFORE SETTING OVEN CONTROLS

Oven vent location

The oven vent is located **under the left side of the control panel** (See Fig. 1). When the oven is on, warm air passes through this vent. This venting is necessary for proper air circulation in the oven and good baking results. **Do not block the oven vent.**

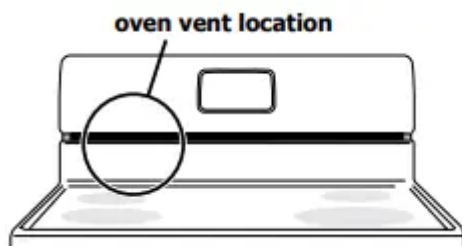

Fig. 1

Removing, replacing & arranging racks

To remove - pull the rack forward until it stops. Lift up front of rack and slide out.

To replace - fit the rack onto the guides on the oven walls. Tilt the front of the rack upward and slide the rack back into place.

Arranging - always arrange the oven racks when the oven is cool (prior to operating the oven).

CAUTION: Always use oven mitts when using the oven. When using the appliance, oven racks and cooktop will become very hot which can cause burns.

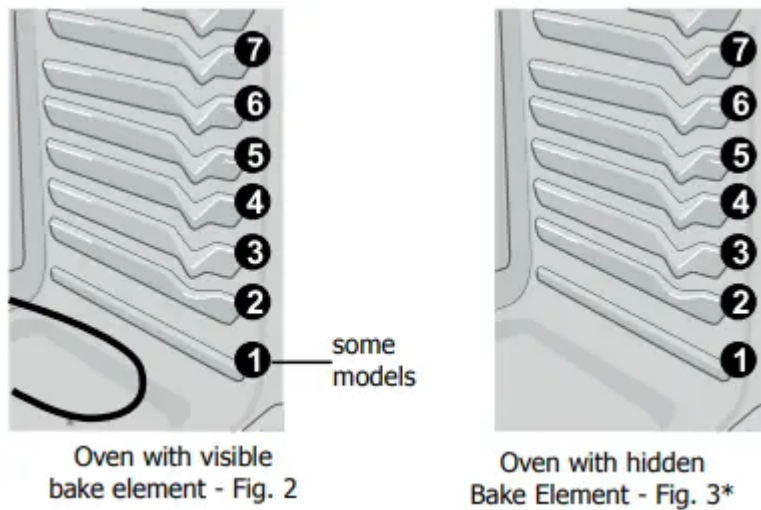

Recommended rack positions by food type

Food type

Broiling meats

Cookies, cakes, pies, biscuits & muffins

Frozen pies, angel food cake, yeast, bread, casseroles

Small cuts of meat or poultry

Turkey, roast or ham

Types of oven racks

Your range may be equipped with one or more of the oven rack styles shown.

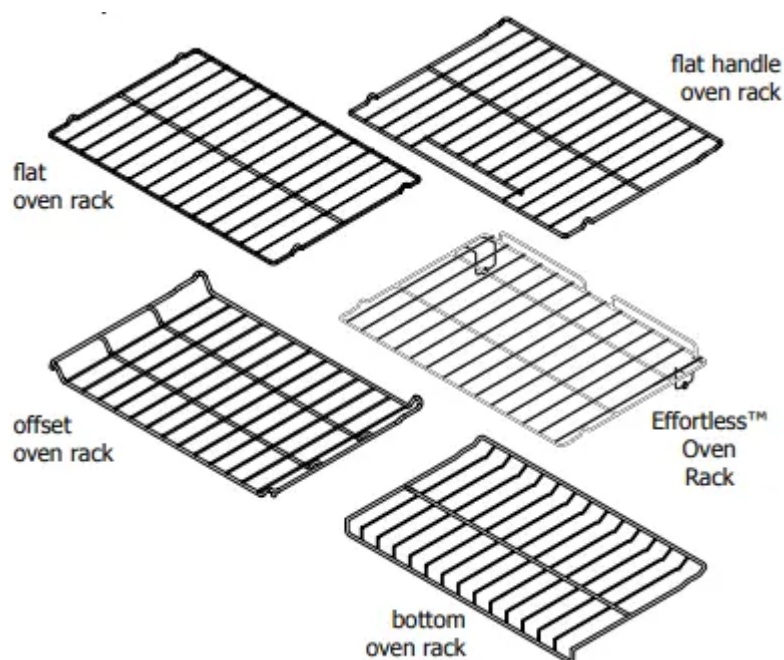

The **flat oven rack** or **flat handle oven rack** (some models) may be used for most cooking needs. The **Effortless™ Oven Rack** (some models) is described later in this section.

The **offset oven rack** (some models) is designed to place the base of the rack about 1/2 of a rack position lower than normal. This rack design provides several additional possible positions between the standard positions.

To maximize oven cooking space place the **bottom oven rack** (some models) in the lowest rack position for baking and when roasting large cuts of meat.

IMPORTANT: Only the Effortless™ Oven Rack should be used in oven rack position 2. Placing any other rack in rack position 2 will prevent the oven door from fully closing.

Position models with visible bake element (Fig. 2)

See broil section

3 or 4

2 or 3

2

Position models with hidden bake element (Fig. 3*)

See broil section

3 or 4

2 or 3

1 or 2

Effortless Oven Rack system

Some models are equipped with a special oven rack system that automatically partially extends the oven rack from the interior oven glides to assist in easier access to your food items. This feature works whenever the oven door is opened or closed.

To assemble the Effortless Oven Rack system:

1. Locate all required parts. You will need the supplied oven rack (Effortless Oven Rack is a flat rack with a special **dark coating** on the **left and right rack sides**) and the 2 supplied chrome connector arms.
2. Open the oven door. Be sure the oven is completely cool before proceeding.
3. Place the oven rack in positions **2, 3 or 4 only** (see previous page to verify positions). Be sure the rack connector brackets are at the rear of the range and pointing towards oven bottom (See Fig. 2).

4. Assemble one connector arm at a time. With the oven door open and the oven rack in place, install one end of the connector arm to the hole in the **door connector bracket** (Fig. 1) and the other end in the hole in the **rack connector bracket** (Fig. 2 and as in Fig. 3). The oven rack may need to be adjusted in or out in the rack position to match the length of the connector arm.
5. While holding the connector arm in place, twist the connector arm so the ends of the connector arm point **upwards** (See Figs. 4 & 5). The connector arm should now be locked into position.
6. Repeat steps 4 and 5 for the other connector arm.
7. Once both connector arms are properly in place, be sure to test the oven rack operation by gently closing the oven door. The oven rack should move in and out of the oven freely when the door is opened or closed.

CAUTION: Never pick up hot oven rack parts. Make sure the oven and oven racks are COMPLETELY cool and safe to touch before attempting to assemble or disassemble the Effortless Oven Rack.

IMPORTANT: REMOVE ALL OVEN RACKS and accessories before starting a self-clean cycle. If the oven racks are left in the oven during the self-clean cycle, the glide ability of the Effortless™ Oven Rack system will be damaged and will cause oven racks to lose their shiny finish. Remove **ALL** oven racks and clean according to instructions provided in the Care & Cleaning section of this manual.

IMPORTANT:

- **Only the Effortless™ Oven Rack system should be used in oven rack position 2.** Placing ANY other rack in oven rack position 2 **will prevent the oven door from fully closing** and **may** damage the oven door, oven cavity or the door connector brackets.
- If the rack system is not assembled with the connector arms the Effortless™ Oven rack may be used in oven rack positions 2 thru 7. Do not attempt to use the Effortless™ Oven rack in rack position 1.

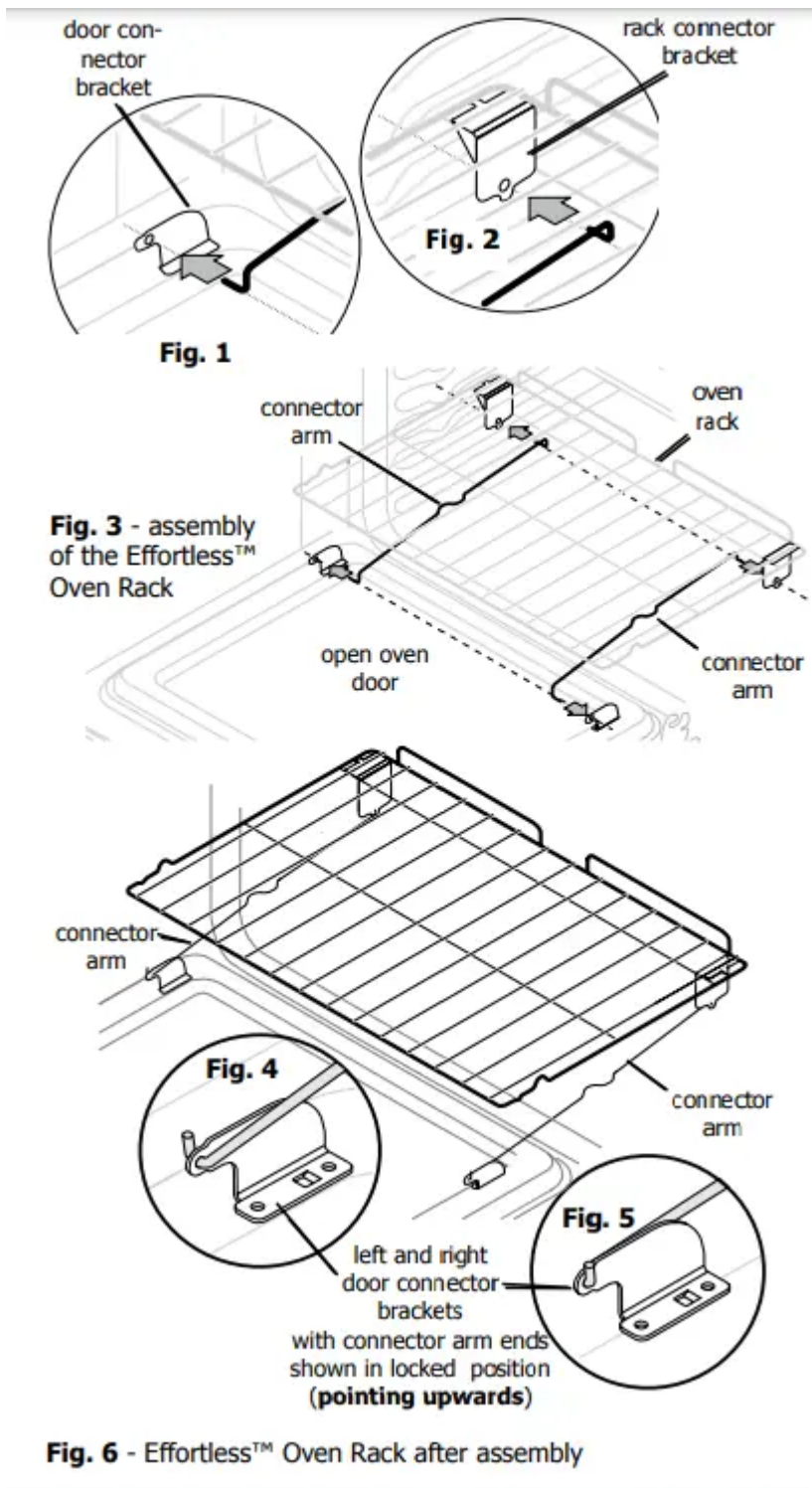

BEFORE SETTING SURFACE CONTROLS

Air circulation in the oven

For best baking results allow 2-4" (5-10 cm) around the cookware for proper air circulation and be sure pans and cookware do not touch each other, the oven door, sides or back of the

oven cavity. Hot air must be able to circulate around the pans and cookware in the oven for even heat to reach around the cookware (See Fig. 1).

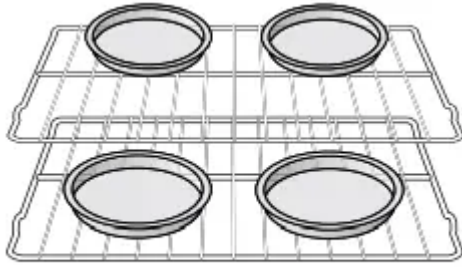

Fig. 1

Baking layer cakes with 1 or 2 oven racks

For best results when baking cakes using 2 oven racks, place cookware on rack positions 3 & 5. For best results when using a single oven flat rack, place cookware on rack positions 3 or 4.

About the ceramic glass cooktop

The ceramic cooktop has radiant surface elements located below the surface of the glass. The design of the ceramic cooktop outlines the area of the surface element underneath. **Be sure** to match the pan size with the diameter of the element outline on the cooktop and only flat-bottomed cookware should be used.

The type and size of cookware, the number of surface elements in use and their settings are all factors that will affect the amount of heat that will spread to areas beyond the surface elements. The areas surrounding the elements may become **hot enough to cause burns**.

About the radiant surface elements

The element temperature rises gradually and evenly. As the temperature rises, the element will glow red. To maintain the selected setting the element will cycle ON and OFF. The heating element retains enough heat to provide a uniform and consistent heat during the off cycle.

For efficient cooking, turn OFF the element several minutes before cooking is complete. This will allow residual heat to complete the cooking process.

Element ON & hot surface indicator lights

Your appliance is equipped with two different types of radiant surface control indicator lights that will glow on the backguard — the **Element On** indicator light and the **Hot Surface** indicator lights (See Fig. 2).

The **Element ON indicator lights** are located on the control panel above each radiant element control knob and will glow when a surface element is turned ON. A quick glance at this indicator light after cooking is an easy check to be sure ALL surface controls are turned OFF. The **Hot Surface** indicator light located on the control panel will glow when any surface cooking area heats up and will **remain on** until the glass cooktop has cooled to a **MODERATE** level.

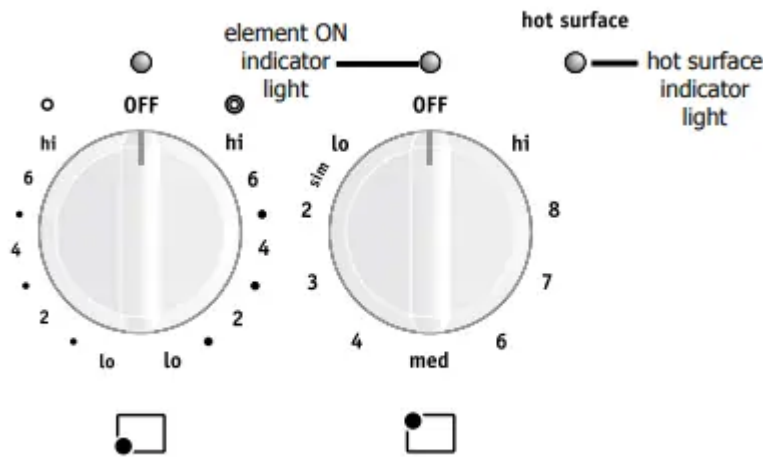

Fig. 2

NOTES:

- Radiant elements have a limiter that allows the surface element to cycle ON and OFF, even at the HI setting. This helps to prevent damage to the ceramic smoothtop. Cycling at the HI setting is normal and will occur more often if the cookware is too small for the radiant element or if the cookware bottom is not flat.
- **Be sure** to read the detailed instructions for ceramic glass cooktop cleaning in the **Care & Cleaning** and **Before You Call** checklist sections of this Use & Care Manual.

Types of cooktop elements

The ceramic glass cooktop has radiant surface elements located below the surface of the glass. The patterns on the ceramic glass will outline the size and type of element available. The **single** radiant element will have one round outline pattern shown (**keep warm** zone is designed to keep food warm only). The **dual** radiant element is flexible because you may set just the smaller inner portion as a single element or both inner and outer portions can be set to heat together (See Fig. 1).

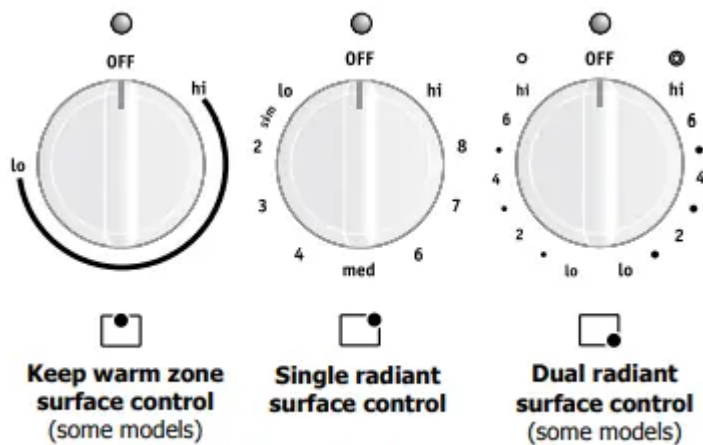

Fig. 1

Cookware material types

The cookware material determines how evenly and quickly heat is transferred from the surface element to the pan bottom. The most popular materials available are:

Aluminum - Excellent heat conductor. Some types of food will cause it to darken (Anodized aluminum cookware resists staining & pitting). If aluminum pans slide across the ceramic cooktop, they may leave metal marks which will resemble scratches. Remove these marks immediately.

Copper - Excellent heat conductor but discolors easily. May leave metal marks on ceramic glass (see Aluminum).

Stainless - Slow heat conductor with uneven cooking results. Is durable, easy to clean and resists staining.

Cast Iron - A slow heat conductor however will retain heat very well. Cooks evenly once cooking temperature is reached. Not recommended for use on ceramic cooktops.

Porcelain-enamel on metal - Heating characteristics will vary depending on base material. Porcelain-enamel coating must be smooth to avoid scratching ceramic cooktops.

Glass - Slow heat conductor. Not recommended for ceramic cooktop surfaces because it may scratch the glass.

Using proper cookware

The size and type of cookware used will influence the setting needed for best cooking results. Be sure to follow the recommendations for using proper cookware as illustrated in Figs. 2 & 3.

Fig. 2

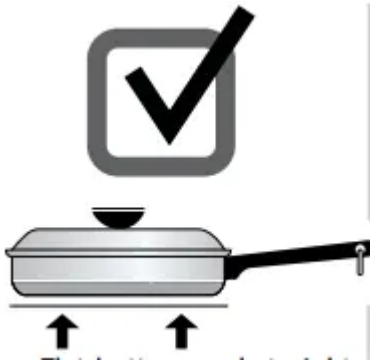

- Flat bottom and straight sides.
- Tight fitting lids.
- Weight of handle does not tilt pan. Pan is well balanced.
- Pan sizes match the amount of food to be prepares and the size of the surface element.
- Made of a material that conducts heat well.
- Easy to clean.
- Always match pot diameter to element size.



- Curved and warped pan.



- Pan larger than cooking area marked on cooktop by more than one-half inch or 12mm.



- Heavy handle tilts pan.



- Pan is smaller or larger than heating area marked on cooktop

Cookware should have flat bottoms that make good contact with the entire surface heating element (See Fig. 2). Check for flatness by rotating a ruler across the bottom of the cookware (See Fig. 3).

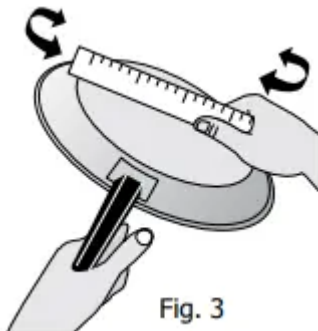

IMPORTANT: Do not place empty aluminum, glass or porcelain-enamel coated cookware on the ceramic cooktop! The melting point of some cookware may be reached if left on the cooktop empty and then can bond to the ceramic cooktop. If the cookware melts it will damage the cooktop! Be sure to follow all the cookware manufacturer's suggestions when using any type of cookware on the ceramic cooktop.

SETTING SURFACE CONTROLS

Single radiant surface elements (all models)

To operate the single radiant element:

1. Place correctly sized cookware on single radiant surface element.
2. Push in and turn the surface control knob in either direction (Fig. 2) to the desired setting (Refer to the **Suggested radiant surface element settings table** Fig. 1). Start most cooking operations on a higher setting and then turn to a lower setting to finish cooking. The surface control knobs do not have to be set exactly on a particular spot. Use the graphics provided as a guide and adjust the control knob as needed (See Fig. 2). Each surface element provides a constant amount of heat at each setting. A glowing red surface heating area extending beyond the bottom edge of the cookware indicates the cookware is **too small** for the surface heating area.
3. When cooking is complete, turn the radiant surface element OFF before removing the cookware.

Suggested radiant surface element settings

The suggested settings found in Fig.1 below are based when cooking with medium-weight aluminum pans with lids. Settings may vary when using other types of pans.

Fig. 1

Suggested settings for single and dual radiant elements table	
Settings	Type of cooking
High (HI - 9)	Start most foods, bring water to a boil, pan broiling
Medium high (7 - 8)	Continue a rapid boil, fry, deep fat fry
Medium (5 - 6)	Maintain a slow boil, thicken sauces and gravies or steam vegetables
Medium Low (2 - 4)	Keep foods cooking, poach, stew
Low (LO - 1)	Keep warm, melt, simmer

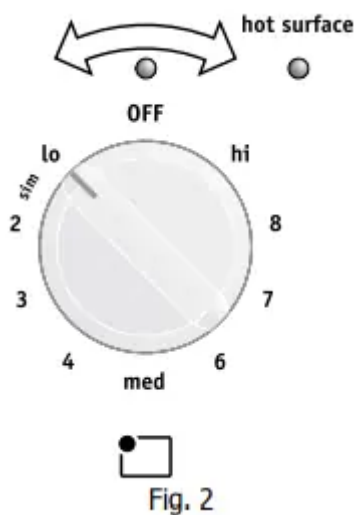

IMPORTANT:



- Radiant surface elements may appear to have cooled after they have been turned off. **The glass surface may still be hot** and burns may occur if the glass surface is touched before it has cooled sufficiently.
- **Do not place flammable items** such as plastic salt and pepper shakers, spoon holders or plastic wrappings on top of the range when it is in use. These items could melt or ignite. Potholders, towels or wooden spoons could catch fire if placed too close to the surface elements.

IMPORTANT: Do not allow aluminum foil, or ANY material that can melt to make contact with the ceramic glass cooktop. If these items melt on the cooktop they will damage the ceramic cooktop.

NOTES:

- The size and type of utensil used, and the amount and type of food being cooked will influence the setting needed for best cooking results.
- The **Element ON** indicator lights will glow when one or more elements are turned ON. A quick glance at these indicator lights when finished cooking is an easy check to be sure all control knobs are turned OFF. The **Hot Surface** indicator light will continue to glow AFTER the control knob is turned to the “OFF” position and will glow until the heating surface area has cooled sufficiently.

Dual radiant surface elements (some models)

Symbols on the backguard will help choose which portion of the dual radiant element to set. The  symbol indicates a setting for the inner coil only. The  symbol indicates a setting for both inner and outer coils.

To operate a dual radiant element:

1. Place correctly sized cookware on dual radiant surface element.
2. Push in and turn the surface control knob clockwise (See Fig. 2) to begin heating both the inner and outer portions of the dual element. If only the inner heating portion is needed for smaller cookware, push in and turn the knob counter-clockwise (See Fig. 1).
3. When cooking is complete, turn the dual radiant surface element OFF before removing the cookware.

Start most cooking operations on a higher setting and then turn to a lower setting to finish cooking. The surface control knobs do not have to be set exactly on a particular mark. Use the marks as a guide and adjust the control knob as needed. A glowing red surface heating area extending beyond the bottom edge of the cookware indicates the cookware is **too small** for the surface heating area.

You may switch from either single or dual element setting at any time during cooking. See **Suggested radiant surface element settings table** on previous page.

CAUTION:

- Radiant surface elements may appear to have cooled after they have been turned off. **The glass surface may still be hot** and burns may occur if the glass surface is touched before it has cooled sufficiently.
- **Do not place flammable items** such as plastic salt and pepper shakers, spoon holders or plastic wrappings on top of the range when it is in use. These items could melt or ignite. Potholders, towels or wooden spoons could catch fire if placed too close to the surface elements.

IMPORTANT: Do not allow aluminum foil, or ANY material that can melt to make contact with the ceramic glass cooktop. If these items melt on the cooktop they will damage the ceramic cooktop.

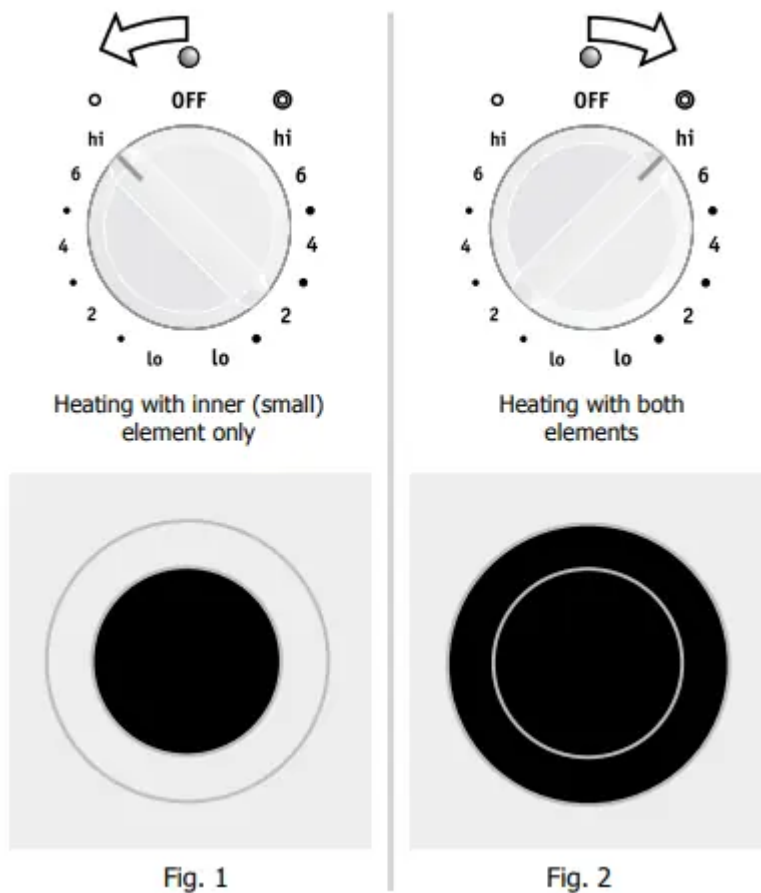

NOTES

- The size and type of utensil used, and the amount and type of food being cooked will influence the setting needed for best cooking results.
- The **Element ON** indicator lights will glow when one or more elements are turned ON. A quick glance at these indicator lights when finished cooking is an easy check to be sure all control knobs are turned OFF. The **Hot Surface** indicator light will continue to glow AFTER the control knob is turned to the "OFF" position and will remain on until the heating surface area has cooled sufficiently

Keep warm (some models)

The purpose of the keep warm zone is to keep hot cooked foods at serving temperature. Use the keep warm feature to keep cooked foods hot such as; vegetables, gravies, casseroles, soups, stews, breads, pastries and oven-safe dinner plates.

Always start with hot food. It is not recommended to heat cold food on the keep warm zone. All food placed on the warming zone should be covered with a lid to maintain quality.

For best results, when warming pastries or breads, the cover should have an opening to allow moisture to escape. **Do not use plastic wrap to cover food. Plastic may melt onto the surface and be very difficult to clean.** Use only dishware, utensils and cookware recommended for oven and cooktop use on the keep warm zone.

Setting the keep warm control:

1. Push in either direction and turn the knob (See Fig 1). The temperatures are approximate, and are designated by **hi** and **lo**. However, the control can be set at any position between **hi** and **lo** for different levels of warming.
2. When ready to serve, turn the control to OFF. The keep warm zone will remain warm until the **indicator light** turns OFF.

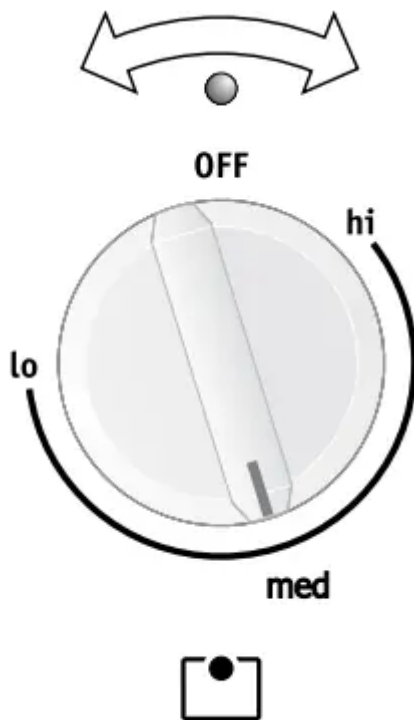

Fig. 1 (with approximate setting for medium shown)

Temperature selection - Refer to the **keep warm zone recommended food settings table** (See Fig. 2). If a particular food is not listed, start with the medium level, and adjust as needed. Most foods can be kept at serving temperatures by using the medium level.

Fig. 2: **Keep warm zone recommended food settings table**



Food Item	Heating Level
Breads/Pastries	LO (Low)
Casseroles	LO (Low)
Dinner Plates with Food	LO (Low)
Eggs	LO (Low)
Gravies	LO (Low)
Meats	MED (Medium)
Sauces	MED (Medium)
Soups (cream)	MED (Medium)
Stews	MED (Medium)
Vegetables	MED (Medium)
Fried Foods	HI (High)
Hot Beverages	HI (High)
Soups (liquid)	HI (High)

CAUTION:

- Unlike the surface elements, the keep warm zone will not glow red when it is hot. To avoid burns always use potholders or oven mitts when removing food from the cooktop including the **keep warm zone** as cookware and plates **will be hot**.
- Radiant surface elements may appear to have cooled after they have been turned off. **The glass surface may still be hot** and burns may occur if the glass surface is touched before it has cooled sufficiently.
- **Do not place flammable items** such as plastic salt and pepper shakers, spoon holders or plastic wrappings on the cooktop when it is in use. These items could melt or ignite. Potholders, towels or wooden spoons could catch fire if placed too close to the surface elements.

IMPORTANT: Do not allow aluminum foil, or ANY material that can melt to make contact with the ceramic glass cooktop. If these items melt on the cooktop they will damage the ceramic cooktop.

Home Canning

Be sure to read and observe all the following points when home canning with your appliance. Check with the USDA (United States Department of Agriculture) website and be sure to read all the information they have available as well as follow their recommendations for home canning procedures.

- Use only quality flat bottom canners when home canning. Use a straight-edge to check canner bottom (see “Cookware material types” in the **Before setting surface controls** section).
- Use only a **completely flat bottom canner** with no ridges that radiate from the bottom center when home canning using a ceramic cooktop.
- **Make sure the diameter of the canner does not exceed 1 inch beyond the surface element markings or burner.** It is recommended to use smaller diameter canners on electric coil and ceramic glass cooktops.
- Start with hot tap water to bring water to boil more quickly.
- Use the highest heat setting when first bringing the water to a boil. Once boiling is achieved, reduce heat to lowest possible setting to maintain that boil.

IMPORTANT: NEVER place or straddle a cooking utensil over 2 different surface cooking areas at the same time. This may cause the ceramic cooktop to fracture.

CAUTION:

- Radiant surface elements may appear to have cooled after they have been turned off. **The glass surface may still be hot** and burns may occur if the glass surface is touched before it has cooled sufficiently.
- **Do not place flammable items** such as plastic salt and pepper shakers, spoon holders or plastic wrappings on the cooktop when it is in use. These items could melt or ignite. Potholders, towels or wooden spoons could catch fire if placed too close to the surface elements.

IMPORTANT: Do not allow aluminum foil, or ANY material that can melt to make contact with the ceramic glass cooktop. If these items melt on the cooktop they will damage the ceramic cooktop.

OVEN CONTROL FUNCTIONS

READ THE INSTRUCTIONS CAREFULLY BEFORE USING THE OVEN.

For satisfactory use of your oven, become familiar with the various keypad functions as described below.

Oven control (for models with Quick Bake only)

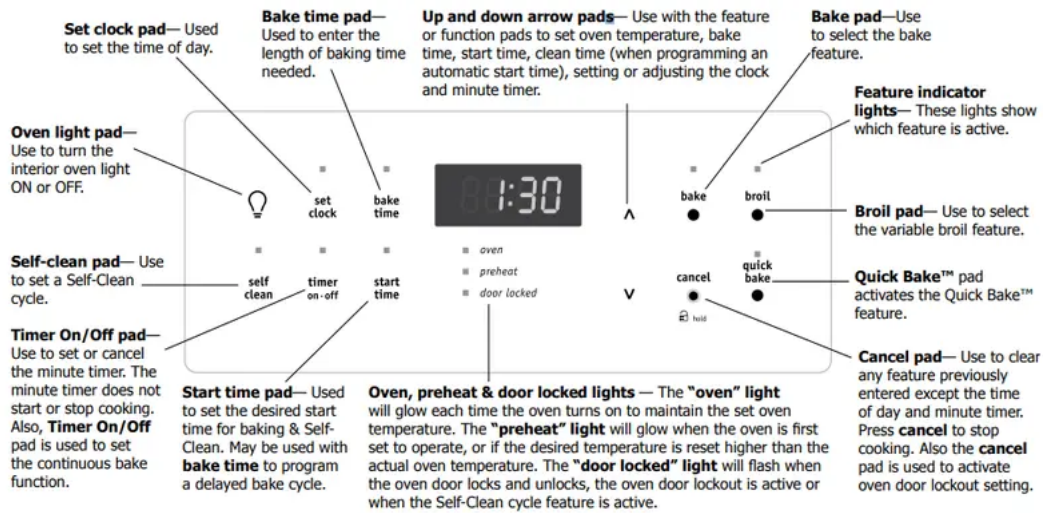

Oven control (for all other models)

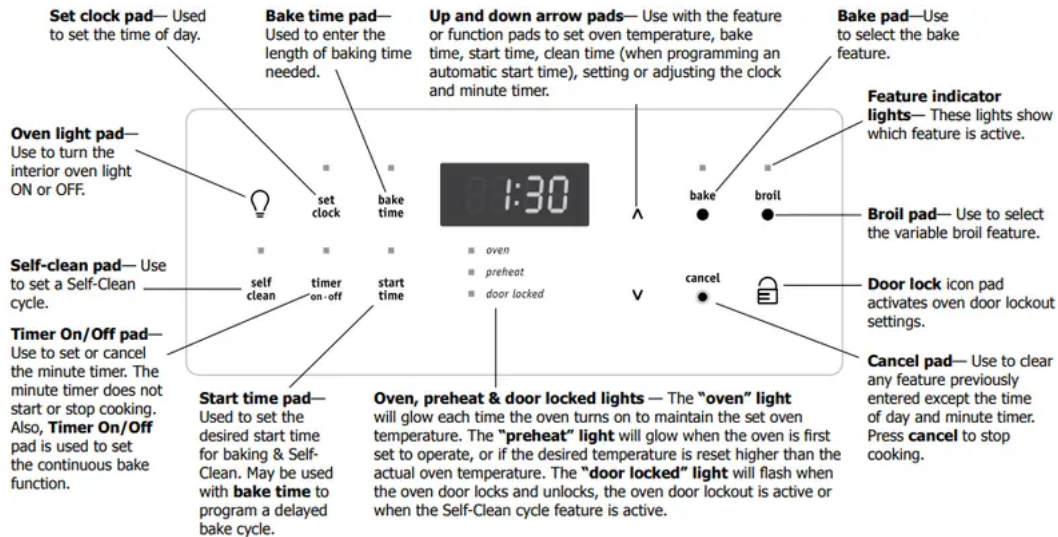

SETTING OVEN CONTROLS

Setting the clock

When the appliance is first plugged in or when the power supply to the appliance has been interrupted, the display will flash “12:00”. It is recommended to always set the clock for the correct time of day before using the appliance.

To set the clock:

1. Press **set clock** once (do not hold pad down).
2. Within 5 seconds, press and hold the **^** or **v** until the correct time of day appears in the display.

NOTE: The time of day cannot be changed when the oven or self-clean is active.

Changing between continuous bake setting or 12-Hour Energy Saving feature

The oven control has a built-in 12-Hour Energy Saving feature that will shut off the oven if the control is left on for more than 11 hours and 59 minutes. The oven can be programmed to override this feature for continuous baking.

Changing to continuous bake setting:

1. Press and hold **timer on-off** down for 5 seconds until a tone sounds. “— — hr” will appear in display for continuous cooking. The current time of day will return to the display.
2. To cancel the continuous bake setting, press **timer on-off** and hold for 5 seconds until a tone sounds. “12hr” will appear in display indicating that the control has returned to the 12-Hour Energy Saving feature.

NOTE: Changing between continuous bake or the 12-Hour Energy saving mode does not change how the cooktop controls operate.

Changing temperature display (°F or °C)

The electronic oven control is set to display in °F (Fahrenheit) when shipped from the factory. The oven can be programmed for any temperature from 170°F to 550°F (77°C to 287°C).

To change the temperature to display °C (Celsius) or from °C to °F (control should not be set for Bake or Self-clean when setting this feature):

1. Press **broil** “— —” appears in the display.
2. Press and hold the **▲** until “HI” appears in the display.
3. Press and hold **broil** until °F or °C appears in the display.
4. Press the **▲** or **▼** to change °F to °C or °C to °F.
5. Press any control pad to return to normal operating mode.

NOTE: The temperature display feature cannot be changed when the oven or self-clean is active.

Setting a silent control panel

When choosing a function, a beep will be heard each time a pad is pressed. If desired, the control can be programmed for silent operation. Press and hold **start time**. After 7 seconds, the control will beep once. This will block the controls from sounding when a pad is pressed. To return the sound, press and hold **start time** again for 7 seconds until the control beeps once.



Setting oven lockout

The control can be programmed to lock the oven door and lockout the oven control pads.

To set the oven lockout feature (for models with Quick Bake)

1. Press and hold for 3 seconds. “**Loc**” will appear in display. the “Door Locked” indicator light will flash and the motor driven door lock will begin to close automatically. **Allow about 15 seconds** for the oven door to lock. Once the oven door is locked. the current time of day will appear in the display.
2. To cancel the oven lockout feature. press and hold for 3 seconds. The control will unlock the oven door and resume normal operation.



To set the oven lockout feature (for models without Quick Bake feature)

1. Press  and hold for 3 seconds. “**Loc**” will appear in display. the “Door Locked” indicator light will flash and the motor driven door lock will begin to close automatically. **Allow about 15 seconds** for the oven door to lock. Once the oven door is locked. the current time of day will appear in the display.
2. To cancel the Oven Lockout feature. press  and hold for 3 seconds. The control will unlock the oven door and resume normal operation.

NOTES

- To avoid possible damage to the oven door latch mechanism. do not attempt to open or close the oven door whenever the DOOR LOCKED indicator light is flashing.
- If a control key pad is pressed when oven lockout is active. **Loc** will appear in the display as a reminder that the key pad action is not available when the oven lockout feature is active.

Setting the minute timer

1. Press  **timer on-off**
2. Press the  to increase the time in one minute increments. Press and hold the  to increase the time in 10 minute increments. The timer can be set for any amount of time from 1 minute to 11 hours and 59 minutes.

Note: If the  pad is pressed first. the timer will advance to 11 hours and 59 minutes.

3. When the set time has run out. the timer will beep 3 times and will continue to beep 3 times every 60 seconds until  **timer on-off** is pressed.

To change the timer while it is in use

While the timer is active and shows in the display, press and hold the **^** or **v** to increase or decrease the time remaining.

To cancel the minute timer before the set time has run out

timer
Press **on-off** once.

NOTES

- The indicator light located above the **timer on-off** pad will glow while the minute timer is active.
- The timer does not start or stop the cooking process. It serves as an extra timer in the kitchen that will beep when the set time has run out. The timer may be used alone or when any other oven function is active.
- The timer will display hours and minutes until 1 hour remains. When less than 1 hour remains, the display will count down in minutes and seconds. Once the timer has less than 1 minute remaining only seconds will display.
- If the timer is active when oven cooking, the minute timer will show in the display by default. To view information of any other active oven function, press the key pad once for the active function to view status.

Setting bake

The oven may be programmed to bake at any temperature from 170°F to 550°F (77°C to 287°C). The factory preset automatic bake temperature is 350°F (177°C).

Note: For optimum cooking results it is recommended to preheat the oven when baking foods such as cookies, biscuits and breads. Use racks 3 and 5 for 2 rack baking and 3 or 4 for single rack baking.

To set bake

1. Press **bake**. “— — —” appears in the display.
2. Within 5 seconds, press the **^** or **v**. The display will show “350°F (177°C).” By pressing and holding the **^** or **v**, the temperature may be adjusted in 5°F increments (1°C if the control is set to display Celsius).
3. As soon as the **^** or **v** keypad is released, the oven will begin heating to the selected temperature. When the displayed temperature reaches the desired baking temperature, the preheat indicator light will turn OFF. The control will beep 3 times as a reminder.
4. To stop bake, press **cancel**.

To change the oven temperature after bake has started

1. Press **bake**. Visually check the bake temperature at this time.

2. Press the **^** or **v** pad to increase or decrease the set temperature to the desired new oven temperature.

IMPORTANT: Dark or dull pans absorb more heat than shiny bakeware resulting in dark or overbrowning of foods. It may be necessary to reduce the oven temperature or cook time to prevent overbrowning of some foods. Dark pans are recommended for pies. Shiny pans are recommended for cakes, cookies and muffins.

NOTES

- A short time after starting bake the **PREHEAT** indicator light will turn OFF, indicating your oven has reached the set baking temperature. The control will sound 3 beeps as a reminder the oven is ready.
- The **OVEN** indicator light on the oven control display will turn ON and OFF while using the Bake feature. This is normal and indicates that the oven elements are cycling to maintain the selected baking temperature.

Setting timed bake and delayed timed bake features

The **bake time** and **start time** pads operate the features that will turn the oven ON and OFF at the times you select in advance. The oven can be programmed to start immediately and shut off automatically (timed bake) or to begin baking at a later time with a delayed start time (delayed timed bake).

CAUTION: Use caution with the timed bake and delayed timed bake features. Foods that can easily spoil such as milk, eggs, fish, meat or poultry, should be chilled in the refrigerator first. Even when chilled, they should not stand in the oven for more than 1 hour before cooking begins, and should be removed promptly when cooking is completed.

To program the oven to begin baking immediately and to shut off automatically (timed bake)

1. Be sure that the clock shows the correct time of day.
2. Place the food in the oven.
3. Press **bake**. “ — — — ° ” appears in the display.
4. Within 5 seconds, press the **^** or **v**. The display will show “350°F (177°C).” By holding the **^** or **v**, the temperature can then be adjusted in 5°F increments (1°C if the control is set to display Celsius).
5. Press **bake time**. “:00” will appear in the display.
6. Press the **^** or **v** until the desired baking time appears in the display.
7. The oven will turn ON and begin heating.

NOTES

- A bake time or start time setting cannot be added when broiling.
- The bake time feature may be added when using Quick Bake (some models).
- The maximum bake time setting is 11 hours & 59 minutes.
- While baking with a bake time setting, press the bake time key pad to display any cook time remaining.

Setting timed bake and delayed timed bake features (cont'd)

WARNING: FOOD POISONING HAZARD. Do not let food sit for more than one hour before or after cooking. Doing so can result in food poisoning or sickness.

CAUTION: Use caution with the timed bake and delayed timed bake features. Foods that can easily spoil such as milk, eggs, fish, meat or poultry, should be chilled in the refrigerator first. Even when chilled, they should not stand in the oven for more than 1 hour before cooking begins, and should be removed promptly when cooking is completed.

To program oven for a delayed start time and to shut-off automatically (delayed Timed Bake)

1. Be sure that the clock shows the correct time of day.
2. Place the food in the oven.
3. Press **bake** . “ — — — ° “ appears in the display.
4. Within 5 seconds, press the **▲** or **▼** . The display will show “350°F (177°C).” By holding the **▲** or **▼** the temperature can then be adjusted in 5°F increments (1°C if the control is set to display Celsius).
5. Press **bake time** “:00” will appear in the display.
6. Press the **▲** or **▼** until the desired baking time appears.
7. Press **start time** . The time of day will appear in the display.
8. Press the **▲** or **▼** until the desired start time appears in the display.
9. Once the controls are set, the control calculates the time when baking will stop in order to start at the time you have set.
10. The oven will turn ON at the delayed start time and begin heating.

When the set bake time runs out

1. “**End**” will appear in the display window and the oven will shut-off automatically.
2. The control will beep 3 times every 60 seconds as a reminder until **cancel** is pressed.

To change the oven temperature or bake time after baking has started

1. Press the function pad you want to change.
2. Press the **▲** or **▼** to adjust the setting.

NOTES

- A timed bake or start time setting cannot be added when broiling.
- The maximum bake time or start time setting is 11 hours & 59 minutes.
- During a delayed timed bake operation the preheat function will be delayed until the set time to start cooking is reached.

Quick Bake (some models)

Benefits of the Quick Bake feature

- Foods will cook faster, saving time and energy.
- Multiple rack baking.
- No special pans or bakeware needed.

How Quick Bake works

Quick Bake uses a fan to circulate the oven's heat uniformly and continuously around the oven. This improved heat distribution allows for fast, even cooking and browning results. It also gives better baking results when using two racks at the same time.

Heated air flows around the food from all sides, sealing in juices and flavors. Meats cooked with **Quick Bake** are juicier. Poultry is crisp on the outside while staying tender and moist on the inside. Breads and pastry brown more evenly. Most foods baked in a standard oven can be cooked faster and more evenly with **Quick Bake**.

Suggestions for Quick Bake

When baking

- For optimum cooking results it is recommended to preheat the oven when baking foods such as cookies, biscuits and breads.
- Reduce oven temperature 25°F from recipe's recommended oven temperature. Follow the remainder of the recipe's instructions using the minimum recommended cook time.
- When using 2 oven racks at the same time, place in positions 3 & 5 for best results (See Fig. 1).

When roasting

- Preheating is not necessary when roasting foods using **Quick Bake**.
 - Since **Quick Bake** cooks food faster, reduce the cook time by 25% from the recommended cook time of your recipe. Check the food at this time. If necessary, increase cook time until the desired doneness is obtained.
- Do not cover foods when dry roasting - this will prevent the air from circulating around the food.

NOTES

- Layer cakes will have better results using the **bake** pad.
- When using Quick Bake (some models) cook time reductions may vary depending on the amount and type of food being cooked.

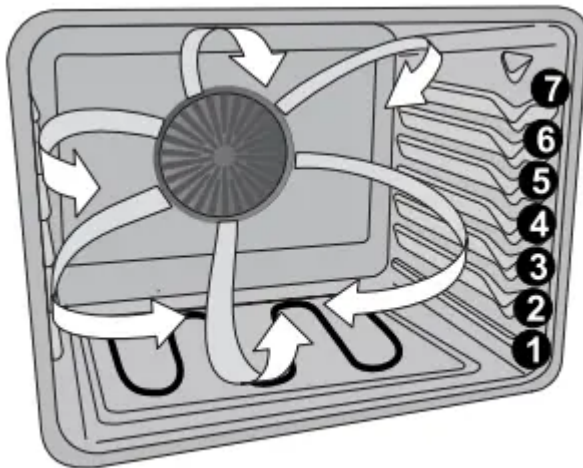

Fig. 1

Setting Quick Bake

The oven can be programmed to Quick Bake at any temperature from 170°F to 550°F (77°C to 287°C). The factory preset automatic bake temperature is 350°F (177°C).

To set Quick Bake

1. Press **quick bake** “— — —” appears in the display.
2. Within 5 seconds, press the **^** or **v**. The display will show “350°F (177°C).” By pressing and holding the **^** or **v** the temperature can then be adjusted in 5°F increments (1°C if the control is set to display Celsius).
3. As soon as the **^** or **v** pad is released, the oven will begin heating to the selected temperature. When the displayed temperature reaches the desired baking temperature, the preheat indicator light will turn OFF and the control will beep 3 times.

4. To cancel quick bake. press

To change the oven temperature after Quick Bake has started

1. Press **quick
bake**
2. If necessary. press the **^** or **v** pad to increase or decrease the oven set temperature.

Setting broil

Use the broil feature to cook meats that require direct exposure to radiant heat for optimum browning results. When broiling always remember to arrange the oven racks while oven is still cool. Position the rack as suggested in the **broil settings table** (See Figs. 1 & 4).

To set Broil

1. Arrange the oven rack while oven is still cool.
2. Press **broil**. “ — — “ will appear in display.
3. Press and hold the **^** or **v** until the desired broil setting level appears in the display.
Press the **^** for **HI** broil or the **v** for **LO** broil. Most foods may be broiled at the **HI** broil setting. Select the **LO** broil setting to avoid excess browning or drying of foods that should be cooked to the well-done stage.
4. **For optimum results. preheat oven for 2 minutes before adding food.**
5. Place the insert on broil pan (if equipped). then place food on broil pan insert (if equipped - See Fig. 2).
6. Place broiler pan and insert on oven rack.
7. **Keep the oven door open** to the broil stop position when broiling (See Fig. 3).
8. Broil food on one side until desired brownness is obtained. Turn food and broil on other side.
9. When finished broiling remove food and press **cancel**

NOTE: Always pull the oven rack out to the stop position before turning or removing the food.

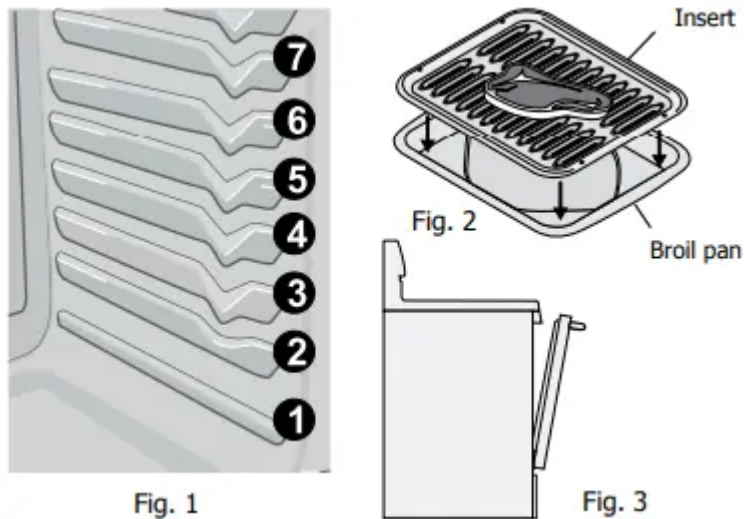

WARNING: Should an oven fire occur, close the oven door and turn the oven OFF. If the fire continues, use a fire extinguisher. **DO NOT** put water or flour on the fire. Flour may be explosive.

CAUTION: The broiler pan and the insert (some models) allows grease to drain and be kept away from the high heat of the broiler. **DO NOT** use the pan without the insert. **DO NOT** cover the insert with foil; the exposed grease could ignite. **DO NOT** use the broil pan without the insert or cover the insert with **aluminum foil**. The exposed fat could ignite. To insure the best results when broiling **ONLY** use Electrolux Home Products, Inc. approved broil pan & insert.

Suggested broil settings table

Fig 4

Food	Rack position	Setting	Cook time in minutes		Internal temperature	Doneness
			1st side	2nd side		
Steak 1" thick	7th*	Hi	4	4	125°F/52°C	Rare
Steak 1" thick	5th or 7th*	Hi	6	4	145°F/63°C	Medium
Steak 1" thick	6th or 7th*	Hi	7	5	160°F/71°C	Medium-well
Steak 1" thick	6th or 7th*	Hi	8	7	170°F/77°C	Well
Pork chops 3/4" thick	6th	Hi	8	6	170°F/77°C	Well
Chicken-bone in	5th	Lo	20	10	170°F/77°C	Well
Chicken-boneless	6th	Lo	8	6	170°F/77°C	Well
Fish	6th	Hi	13	n/a	170°F/77°C	Well
Shrimp	5th	Hi	5	n/a	170°F/77°C	Well
Hamburger 1" thick	7th*	Hi	4	4	125°F/52°C**	Rare
Hamburger 1" thick	7th*	Hi	9	7	145°F/63°C**	Medium
Hamburger 1" thick	6th	Hi	10	8	170°F/77°C	Well

*Use the off-set rack if you choose to use oven rack position 7.



**We recommend following the USDA guidelines of 160°F/71°C as a safe minimum internal temperature for Ground beef. Consuming raw or undercooked meats, poultry, seafood or shellfish may increase your risk of food borne illness.

*** Broiling is direct heat cooking and will produce some smoke. If smoke is excessive, place food further away from the element. Always watch food carefully to prevent burning.



Adjusting the oven temperature

Your appliance has been factory calibrated and tested to ensure an accurate baking temperature. For the first few uses, follow your recipe times and temperature recommendations carefully. If you think the oven is cooking too hot or too cool for your recipe times, you can adjust the control so the oven cooks hotter or cooler than the temperature displayed.

To adjust oven temperature

1. Press **bake**
2. Set the temperature to 550°F (287°C) by pressing and holding the  keypad.
3. Within 2 seconds, press and hold **bake** until the 2 digit display appears. Release **bake** keypad. The display now indicates the amount of degrees offset between the original factory temperature setting and the current temperature setting. If the oven control has the original factory calibration, the display will read "0."
4. The temperature can now be adjusted up or down 35°F (19°C), in 5°F increments by pressing and holding the  or  keypad. Adjust until the desired amount of offset appears in the display. When lowering the oven temperature, a minus sign (-) will appear before the number to indicate that the oven will be cooler by the displayed amount of degrees.
5. When you have made the desired adjustment, press **cancel** to go back to the time of day display

NOTES

- Any oven temperature offset made will not affect the broil or self-cleaning feature temperatures.
- If the oven display has been set to display Celsius, adjustments made will be in 1°C increments with each press of the  or  keypad.
- **DO NOT USE** oven thermometers such as those found in grocery stores to check the temperature settings inside the oven. These oven thermometers may vary as much as 20 to 40 degrees from actual temperatures.

Operating the oven light

The interior oven light will automatically turn ON when the oven door is opened.

Press  to turn the interior oven light ON and OFF whenever the oven door is closed.

The interior oven light is located at the upper left rear wall of the oven interior and is covered with a glass shield held by a wire holder. The glass shield must be in place whenever the oven is in use.

To change the interior oven light, see “Changing the oven light” in the **Care & Cleaning** section.

Self-Cleaning

A self-cleaning oven cleans itself with high temperatures (well above normal cooking temperatures) which eliminate soils completely or reduces them to a fine powdered ash you can wipe away with a damp cloth.

IMPORTANT: Read before starting self-clean

- **Completely remove ALL OVEN RACKS and ANY ACCESSORIES FROM OVEN CAVITY** to avoid possible damage to oven racks. If the oven racks are not removed they may discolor. The Effortless Oven Rack system must be removed during the self-clean cycle to avoid damaging the glide ability of the rack.
- Remove **ALL** items from the oven and cooktop including **cookware, utensils and ANY ALUMINUM FOIL**. Aluminum foil will not withstand high temperatures from a self-clean cycle.
- **DO NOT** line the oven walls, racks, bottom or any other part of the range with aluminum foil. Doing so will destroy heat distribution, produce poor baking results and may cause permanent damage to the oven interior. During self-clean temperatures in the oven can become hot enough to melt aluminum foil.
- **DO NOT** use or spray oven cleaners or oven protective coatings in or around any part of the oven interior.
- Clean any soil from the outer oven frame, the door liner outside the oven door gasket and the small area at the front center of the oven bottom. These areas (See Fig. 1) heat sufficiently to burn soil on. Clean using soap and water before starting self-clean.
- Remove any excessive **spillovers**. Any spills on the oven bottom should be wiped-up and removed **before starting self-clean**. To clean, use hot, soapy water and a cloth. Large spillovers can cause heavy smoke or fire when subjected to high temperatures. **DO NOT** allow food spills with a high sugar or acid content (such as milk, tomatoes, sauerkraut, fruit juices or pie filling) to remain on the surface as they may leave a dull spot even after cleaning.
- **DO NOT clean the oven door gasket** (See Fig. 1). The woven material of the oven door gasket is essential for a good seal. Care should be taken not to rub, damage or remove the gasket. **DO NOT** use any cleaning materials on the oven door gasket. Doing so could cause damage to the door gasket.

CAUTION:

- **DO NOT** leave small children unattended near the appliance. During the self-cleaning cycle, the outside of the range can become very hot to the touch.
- The health of some birds is extremely sensitive to the fumes given off during the self-cleaning cycle of any range. Move birds to another well-ventilated room.
- **DO NOT** force the oven door open when self-clean is active. This can damage the automatic door locking system. Use caution when opening the door after the self-Cleaning cycle is completed. The oven may still be **VERY HOT**.
- The oven bake and broil elements may appear to have cooled after they have been turned OFF. **The elements may still be hot** and burns may occur if these elements are touched before they have cooled sufficiently.



Fig. 1

(For models that have a visible bottom bake element ONLY) To help remove excessive spills from the oven bottom, the lower element may be tilted up from the front of the element. Wait until the oven is completely cool and remove the bottom oven rack before attempting to raise the element. Do not to raise the lower element more than 4 or 5 inches from the resting position.



SELF-CLEANING

Setting a self-clean cycle or a delayed start self-clean cycle

Setting a self-clean cycle

1. Remove all items and oven rack from the oven and close the oven door. Be sure the clock displays the correct time of day.

IMPORTANT: To start a self-clean cycle immediately without a **delay**, skip steps 2 & 3 in the instructions provided below.

2. Press **start time** The “ : ” in the time of day will flash.

3. Press and hold the **^** pad to scroll to the time to start the delayed Self-Clean cycle. Release the pad when the desired time is displayed

4. Press **self clean** “---” appears in the display.

5. Press the **^** or **v** pad once. “3:00” will appear in the display indicating that a 3 hour self-clean time is set. To change to a 2 hour self-clean time press **v** once (2:00 appears in the display).

(some models) To self-clean using a 4 hour clean time press **^** once (4:00 appears in display).

NOTE: As soon as the controls are set, the motor driven lock will begin to automatically lock the oven door. The “LOCK” indicator light will flash. **DO NOT** open the oven door while the indicator is flashing (it takes about 15 seconds for the oven door to completely lock).

6. “CLn” will appear in the display during the self-clean cycle and the “LOCK” light will glow until the self cleaning cycle is complete or cancelled and the oven temperature has cooled.

When the self-clean cycle has completed:

1. The time of day will appear in the display window and the “Clean” and “LOCK” light will continue to glow.
2. Once the oven has cooled down for about 1 HOUR and the “LOCK” light has turned off, the oven door can be opened.

Stopping or interrupting a self-clean cycle

If it becomes necessary to stop or interrupt a self cleaning cycle once it has been activated:

1. Press **cancel**.

2. Once the oven has cooled down (about 1 hour) and the “LOCK” light has turned off, the oven door can be opened.
3. If needed, the self-clean may be restarted.

CAUTION:

- To avoid possible burns use care when opening the oven door after the self-cleaning cycle. **Stand to the side of the oven** when opening the door to allow hot air or steam to escape.
- **DO NOT** force the oven door open. This can damage the automatic door locking system. Use caution and avoid possible burns when opening the oven door after the self-cleaning cycle has completed. The oven may still be **VERY HOT**.

NOTES

- Whenever the self-clean feature is active you may check the amount of time remaining in the self-clean cycle by pressing the **self clean** keypad once. Remember the oven door cannot be opened until the range has cooled sufficiently. You will need to **add about 1 hour to the time** displayed before you can use the oven for cooking again.
- After the oven door has unlocked and the oven has completely cooled, wipe away any residue or powdered ash with a damp cloth or paper towel.

CARE & CLEANING

Cleaning recommendation table



Surface type	Recommendation
<ul style="list-style-type: none"> • Control knobs (some models) • Painted body parts • Painted decorative trim • Aluminum, plastic or vinyl trim 	<p>For general cleaning, use hot, soapy water and a cloth. For more difficult soils and built-up grease, apply a liquid detergent directly onto the soil.</p> <p>Leave on soil for 30-60 minutes. Rinse with a damp cloth and dry. Do not use abrasive cleaners on any of these materials; they can scratch. To remove control knobs, turn to OFF position; grasp firmly and pull straight off the shaft. To replace knobs after cleaning, line up the flat sides of both knob and shaft; then push knob into place.</p>
<ul style="list-style-type: none"> • Control panel • Control key pad membrane • Decorative trim (some models) 	<p>Before cleaning the control panel, turn all controls OFF, activate oven lockout (on some models) and if needed remove any knobs from panel. Do not use abrasive cleaners on any of these materials; they can scratch. Clean using hot, soapy water and a dishcloth. Be sure to squeeze excess water from dishcloth before wiping control panel; especially when wiping around the controls area. Excess water in or around the controls may cause damage to the appliance. When rinsing, use clean water and a dishcloth and be sure to squeeze excess water from dishcloth before wiping the control panel.</p>
<ul style="list-style-type: none"> • Easy Care™ Stainless Steel (some models) 	<p>If your range finish is Easy Care™ Stainless Steel (some models), clean the stainless with warm soapy water using a clean sponge or cloth. Rinse with clean water and dry with a soft clean cloth. DO NOT use ANY store bought cleaners like Stainless Steel cleaners or any other types of cleaners containing any abrasive, chlorides, chlorines or ammonia. It is recommended to use mild dish soap and water or a 50/50 solution of water and vinegar.</p>

<ul style="list-style-type: none"> • Porcelain enamel parts • Porcelain enamel broiler pan and broiler pan insert (if equipped) 	<p>Gentle scrubbing with a soapy no-scratch cleaning pad will remove most spots. Rinse with a 1:1 solution of clear water and ammonia. If necessary, cover difficult spots with an ammonia-soaked paper towel for 30 to 40 minutes. Rinse with clean water and a damp cloth, and then scrub with a soap-filled no-scratch cleaning pad. Rinse and wipe dry with a clean cloth.</p> <p>Do not allow food spills with high sugar or acid content (milk, tomatoes, sauerkraut, fruit juices or pie filling) to remain on the surface; they may cause a dull spot even after cleaning.</p>
<ul style="list-style-type: none"> • Oven interior 	<p>Remove excessive spillovers from oven cavity bottom before starting self-clean. Clean any soils from oven frame and door liner outside the oven door gasket. For very important preparation information be sure to read all the instructions in the Self-Cleaning section.</p>
<ul style="list-style-type: none"> • Oven racks 	<p>Oven racks must be removed from oven. Do not clean oven racks in oven during the self-clean cycle. Remove and clean using a mild, abrasive cleaner following manufacturer's instructions. Thoroughly rinse and dry.</p>
<ul style="list-style-type: none"> • Oven door 	<p>Use soap & water to thoroughly clean the top, sides and front of the oven door. Rinse well. You may use a glass cleaner on the outside glass of the oven door. Do not immerse the door in water. Do not spray or allow water or the glass cleaner to enter the door vents. Do not use oven cleaners, cleaning powders or any harsh abrasive cleaning materials on the outside of the oven door. Do not clean the oven door gasket. On selfcleaning models the oven door gasket is made of a woven material which is essential for a good seal. Care should be taken not to rub, damage or remove this gasket.</p>
<ul style="list-style-type: none"> • Ceramic cooktop 	<p>See Cooktop Cleaning and Maintenance in the Care & Cleaning section.</p>

Cooktop maintenance

IMPORTANT: Consistent and proper cleaning is essential to maintaining your ceramic glass cooktop.

Prior to using your cooktop for the first time, apply a ceramic cooktop cleaning cream (available in most hardware, grocery and department stores) to the ceramic surface. Clean

and buff with a clean paper towel. This will make cleaning easier when soiled from cooking. Cooktop cleaning creams leave a protective finish on the glass to help prevent scratches and abrasions.

Sliding aluminum or copper clad bottom pans on the cooktop can cause metal markings on the cooktop surface. These marks should be removed **immediately** after the cooktop has cooled using the cooktop cleaning cream. Metal marks can become permanent if not removed prior to future use. Cookware (cast iron, metal, ceramic or glass) with rough or dirty bottoms can **mark or scratch** the cooktop surface.

To maintain the cooktop appearance DO NOT:

- Slide anything metal or glass across the cooktop.
- Use cookware with dirt or dirt build up on bottom; replace with clean cookware before using.
- Use your cooktop as a cutting board or work surface in the kitchen.
- Cook foods directly on the cooktop surface without a pan.
- Drop heavy or hard objects on the ceramic glass cooktop, they may cause it to crack.

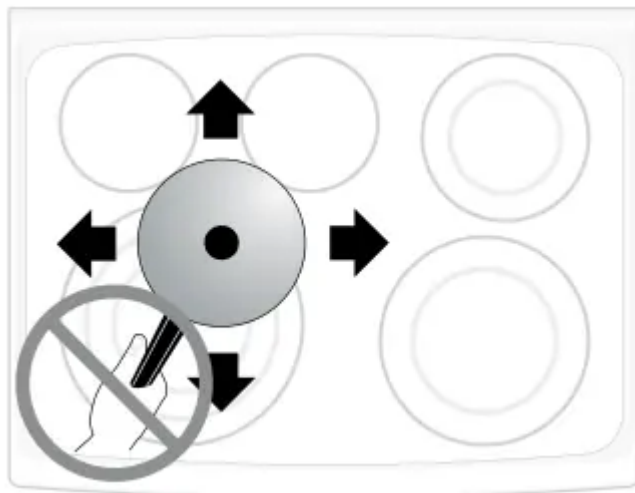

Cooktop cleaning

CAUTION: Before cleaning the cooktop, be sure the controls are turned to OFF and the cooktop is COOL.

WARNING: DO NOT use a cooktop cleaner on a hot cooktop. The fumes can be hazardous to your health and can chemically damage the ceramic glass surface.

For light to moderate soil- Apply a few drops of cooktop cleaning cream directly to the cooktop. Use a clean paper towel to clean the entire cooktop surface. Make sure the cooktop is cleaned thoroughly, leaving no residue. Do not use the towel you use to clean the cooktop for any other purpose.

For heavy, burned on soil- Apply a few drops of glassceramic cooktop cleaner directly to the soiled area. Rub the soiled area using a non-abrasive plastic type noscratch cleaning pad, applying pressure as needed. Do not use the pad you use to clean the cooktop for any other purpose.

If soils remain, carefully scrape soils with a metal razor blade scraper, holding scraper at a 30 degree angle to the surface. Remove loosened soils with cooktop cleaning cream and buff surface clean.

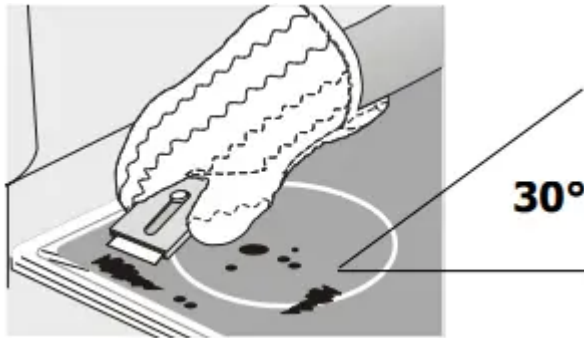

Removing plastic or foods with a high sugar content: These types of soils need be removed immediately if spilled or melted onto the ceramic cooktop surface. Permanent damage (such as pitting of the cooktop surface) may occur if not removed **immediately**. After turning the surface elements OFF, use a razor blade scraper or a metal spatula with a mitt and scrape the soil from the hot surface (as illustrated). Allow the cooktop to cool, and use the same method for heavy or burned on soils.

IMPORTANT: Damage to the ceramic glass cooktop may occur if you use an abrasive cleaning pad. Only use cleaning products that have been specifically designed for cooktops.

Cooktop cleaning (cont'd)

DO NOT use the following on the cooktop:



- Do not use abrasive cleaners and scouring pads, such as metal and some nylon pads. They may scratch the cooktop, making it more difficult to clean.
- Do not use harsh cleaners, such as chlorine bleach, ammonia or oven cleaners, as they may etch or discolor the cooktop.
- Do not use dirty sponges, cloths or paper towels, as they can leave soil or lint on the cooktop which can burn and cause discoloration.

Aluminum foil and oven liners

WARNING: Protective liners—Do not use aluminum foil to line the oven bottom. Only use aluminum foil as recommended in this manual. Improper installation of these liners may result in risk of electric shock, or fire.

Using a liner in the oven will restrict the heat and air flow needed to obtain the best possible cooking results for any oven, including the warmer drawer (some models).

Do not use oven bottom liners or use aluminum foil to cover the oven bottom or any oven racks.

During self-clean the oven temperature can become hot enough to melt aluminum cooking utensils or aluminum foil which could result in damage to the oven interior porcelain finish



To replace the oven light bulb:

1. Turn electrical power off at the main source or unplug the range.
2. While holding the glass shield in place, press wire holder to one side to release the glass shield.
3. Remove glass shield. Replace bulb with a new 40 watt appliance bulb.
4. Replace glass shield over bulb and snap wire holder into place.
5. Turn power back on again at the main source (or plug the range back in).
6. The clock will then need to be reset. To reset, see Setting the Clock and Minute Timer in this Use & Care Manual.

The glass shield must always be in place to protect and shield the oven interior light whenever using the oven.

Be sure the range is unplugged and all parts are COOL before replacing oven light. Wear a leather-faced glove for protection against possible broken glass.

Aluminum foil and oven liners (cont'd)

Aluminum foil and the cooktop - Use of aluminum foil on a hot cooktop can damage the ceramic glass. Do not use thin aluminum cooking utensils or allow aluminum foil to touch the ceramic cooktop under ANY circumstances.

Aluminum utensils and the cooktop - Care must be taken when aluminum pots or pans are used on the cooktop. If aluminum pans are allowed to boil dry when using the cooktop, the utensil be damaged or destroyed, and may fuse to, break or mark the ceramic glass surface, permanently damaging the cooktop surface.

Replacing interior oven light

CAUTION: Be sure the range is unplugged and all parts are COOL before replacing oven light. Wear a leather-faced glove for protection against possible broken glass.

The interior oven light is located at the rear of the oven interior back wall and is covered with a glass shield held by a wire holder.

The glass shield must always be in place to protect and shield the oven interior light whenever using the oven.

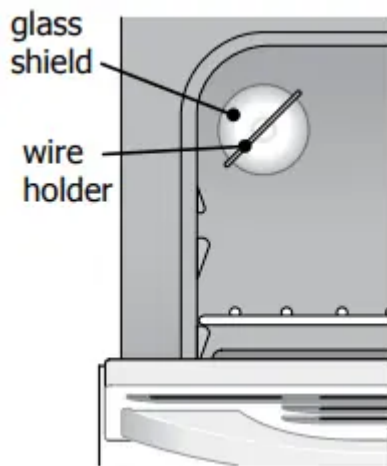

To replace the oven light bulb:

1. Turn electrical power off at the main source or unplug the range.
2. While holding the glass shield in place, press wire holder to one side to release the glass shield.
3. Remove glass shield. Replace bulb with a new 40 watt appliance bulb.
4. Replace glass shield over bulb and snap wire holder into place.
5. Turn power back on again at the main source (or plug the range back in).
6. The clock will then need to be reset. To reset, see **Setting the Clock and Minute Timer** in this Use & Care Manual.

Removing and replacing the lift-off oven door

CAUTION:

- To avoid possible injury when removing or replacing the oven door, follow the instructions below carefully and always hold the door with both hands positioned away from the door hinge area.
- The door is heavy. For safe, temporary storage, lay the door flat with the inside of the door facing down.

To remove oven door:

1. Open oven door completely (horizontal with floor - See Fig. 1).

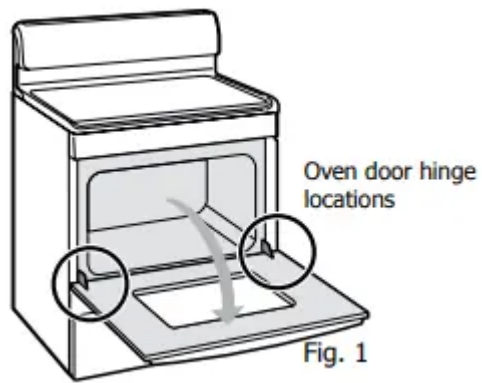

2. Pull the door hinge locks on both left and right door hinges down from the oven frame completely towards the oven door to unlock (See Fig. 2). A tool such as a small flat-blade screwdriver may be required.

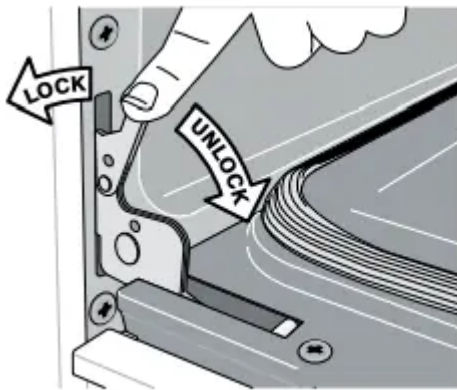

Fig. 2

3. Firmly grasp both sides of oven door along the door sides (Do not use the oven door handle).
4. Close the door to the broil stop position. The oven door will stop into this position just before fully closing.
5. With the oven door in the broil stop position lift the oven door hinge arms over the roller pins located on each side of the oven frame (see fig. 4)

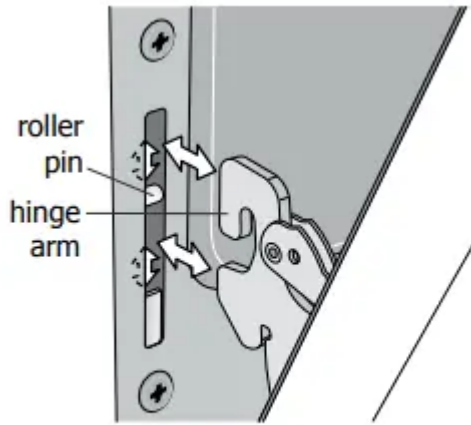

Fig. 4

To replace oven door:

1. Firmly grasp both sides of oven door along the door sides (Do not use the oven door handle - see fig 3).

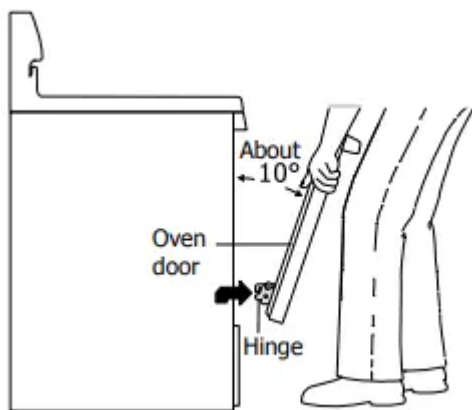

Fig. 3

2. Holding the oven door at the same angle as the removal position, sit the hook of the hinge arm over the roller pins located on each side of the oven door frame (See Fig. 4). The hook of the hinge arms must be fully seated onto the roller pins.

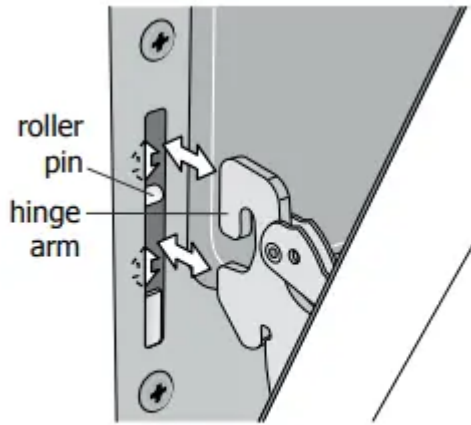
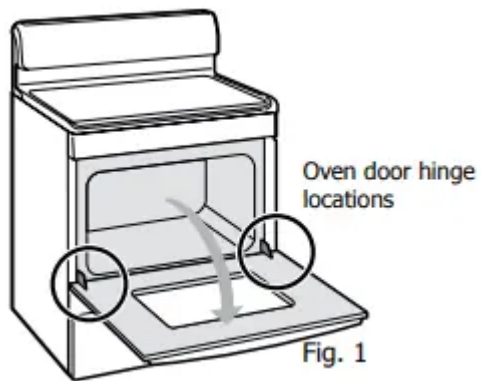

Fig. 4

3. Fully open the oven door (horizontal with floor - See Fig. 1).



4. Push the door hinge locks up towards and into the oven frame for both left and right oven door hinges to the locked position (See Fig. 2).

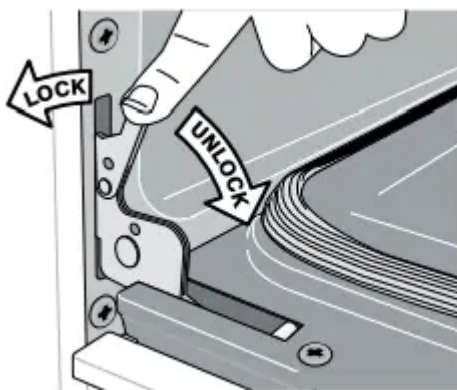

Fig. 2

5. Close the oven door.

Special door care instructions - Most oven doors contain glass that can break. Read the following recommendations:

1. **Do not** close the oven door until all the oven racks are fully positioned into the oven interior.
2. Do not hit the glass with pots, pans, or any other object.
3. Scratching, hitting, jarring or stressing the glass may weaken its structure causing an increased risk of breakage at a later time.

BEFORE YOU CALL

Solutions to common problems



Problem	Solution
<p>Oven control beeps and displays F code (fault code) error.</p>	<ul style="list-style-type: none"> • The oven control has detected a fault or error condition. Press cancel to clear the display & stop beeping. Try the bake or broil feature again. If the F code error repeats, remove electric power from appliance, wait 5 minutes and then repower appliance and set clock for the time of day. Try the bake or broil feature again. If the fault recurs, record fault and call your authorized service agent.
<p>Poor baking results.</p>	<ul style="list-style-type: none"> • Allow oven to preheat to the set temperature before placing food in oven. • Make sure the proper oven rack position is used. • Center food in the oven and space pans to allow air to circulate. • Try adjusting the recipe's recommended temperature or baking time. • If you feel the oven is too hot or cool, see "Adjusting oven temperature" in Setting Oven Controls section.
<p>Appliance is not level.</p>	<ul style="list-style-type: none"> • Be sure floor is level, strong & stable enough to support the appliance. If floor is sagging or sloping, contact a carpenter to correct the problem. • Cooktop or oven racks not level. To correct, place oven rack in center of oven. Place a bubble level on the oven rack. Adjust by turning leveling legs at base of appliance until the oven rack rests level. • Kitchen cabinet alignment may make range appear not level. Be sure cabinets are square & have sufficient room for appliance clearance.
<p>Cannot move appliance easily. Appliance must be accessible for service.</p>	<ul style="list-style-type: none"> • Cabinets not square or are built in too tightly to appliance sides. Contact builder or installer to make appliance accessible. • Carpet interferes with appliance. Provide sufficient space so appliance may be lifted over carpet.
	<ul style="list-style-type: none"> • Make sure power cord is plugged correctly into outlet.



<p>Entire appliance does not operate.</p>	<ul style="list-style-type: none"> • Electrical power outage. Check house lights to be sure. Call your local electric company for service. • Service wiring is not complete. Contact your dealer, installing agent or authorized service agent.
<p>Oven portion of appliance does not operate.</p>	<ul style="list-style-type: none"> • Be sure the oven controls are set properly for the desired cooking feature. See Setting Oven Controls section in this manual or see “Entire appliance does not operate” in this checklist. • The time of day is not set. The time of day must first be set in order to properly operate the oven. See “Setting the clock” in Setting Oven Controls section.
<p>Surface element does not heat cookware</p>	<ul style="list-style-type: none"> • Lightweight or warped pans used. Use only flat, evenly balanced, medium or heavyweight quality cookware. Flat pans heat better than warped pans. Cookware materials and weight of the material affect heating. Heavy & medium-weight pans heat evenly. Because lightweight pans heat unevenly, foods may burn easily.
<p>Surface element seems too hot or not hot enough.</p>	<ul style="list-style-type: none"> • Incorrect control setting. Be sure the matching control is set for the surface element that you are attempting to use or adjust power level setting.
<p>Flames inside oven or smoking from oven vent.</p>	<ul style="list-style-type: none"> • Excessive spillovers in oven. For example this will happen for pie spillovers or large amounts of grease left on the oven bottom. Wipe up excessive spillovers before starting oven. If flames or excessive smoke are present see “Broiling” in the Setting Oven Controls section for additional recommendations.
<p>Oven smokes excessively when broiling.</p>	<ul style="list-style-type: none"> • Incorrect setting or food preparation. Follow broiling instructions in Setting Oven Controls section. • Make sure oven door is open to broil stop position. • Food positioned too close to upper element. Reposition the food item lower if necessary to provide proper clearance between the food & the broil element. Try preheating the oven before broiling. • Food not properly prepared. Remove excess fat from meat. Cut remaining fatty edges to prevent curling.



	<ul style="list-style-type: none"> • Broil pan and insert (some models) wrong side up and grease not draining. Always place insert on top of broil pan with ribs up & slots down to allow excess grease to drip into broil pan. • Do not use aluminum foil. Aluminum foil will trap grease, expose grease to high temperatures and increase smoking. • Grease has built up on interior oven surfaces. Regular cleaning is necessary if broiling frequently. Old grease or food spatters cause excessive smoking.
Convection does not work (some models)	<ul style="list-style-type: none"> • Oven control not set properly. Review instructions for “Quick Bake” in “Setting Oven Controls” section. • See “Convection fan does not rotate” in this checklist
Convection fan does not rotate (some models)	<ul style="list-style-type: none"> • Oven door is open. The convection fan will turn off if oven door is opened when any convection feature is active. Close oven door
Self-cleaning cycle does not work	<ul style="list-style-type: none"> • Oven control not set properly for self-clean. Follow the instructions provided in the “Self-Cleaning” section of this manual. • Self-clean cycle was interrupted. Refer to the “Self-Cleaning” section for more detailed information.
Soil not completely removed after running a self-cleaning cycle.	<ul style="list-style-type: none"> • Dirty front oven frame outside oven door gasket area. These areas are not within the self-cleaning area, but get hot enough to burn on residue. Manually clean these areas before starting a self-clean cycle. • Excessive food spillovers in oven. Wipe up spillovers before starting selfclean cycle.
Oven light does not work	<ul style="list-style-type: none"> • See “Replacing the interior oven light” in the Care & Cleaning section. Also be sure the oven light bulb is secure in the socket.
Scratches or abrasions on cooktop surface	<ul style="list-style-type: none"> • Coarse particles such as salt or sand between cooktop and utensils can cause scratches. Be sure cooktop surface and bottoms of utensils are clean before usage. Small scratches do not affect cooking and will become less visible with time. • Cleaning materials not recommended for ceramic-glass cooktop have been used. See “Cooktop Cleaning” and



	<p>“Cooktop Maintenance” in the Care and Cleaning section of this Use & Care Guide.</p> <ul style="list-style-type: none"> • Cookware with rough bottom has been used. Use smooth, flat-bottomed cookware
Metal marks on the cooktop.	<ul style="list-style-type: none"> • Sliding or scraping of metal utensils on cooktop surface. Do not slide metal utensils on cooktop surface. Use a ceramic-glass cooktop cleaning creme to remove the marks. See “Cooktop Cleaning and Maintenance” in the Care & Cleaning section.
Brown streaks or specks on cooktop surface.	<ul style="list-style-type: none"> • Spillovers are cooked onto ceramic surface. Use razor blade scraper to remove soil. See “Cooktop Cleaning” and “Cooktop Maintenance” in the Care & Cleaning section.
Areas of discoloration with metallic sheen on cooktop surface.	<ul style="list-style-type: none"> • Mineral deposits from water and food. Remove using a ceramic-glass cooktop cleaning creme. Use cookware with clean, dry bottoms.

Warning

This content is compiled from multiple sources and is provided for reference purposes only. It may not be complete or fully applicable to all situations. If you are unable to resolve your issue, please contact the product manufacturer or an authorized service provider for official support.