

Installation

Where to install the tumble dryer

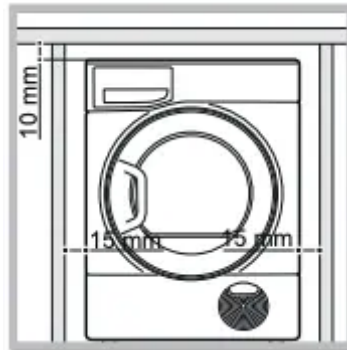

If the dryer is installed below a worktop, ensure there are 10 mm between the upper panel of the dryer and any objects above it, and 15 mm between the sides of the machine and the walls or furniture units adjacent to it. This ensures adequate air circulation. The appliance must be installed with the rear surface placed against a wall.

Ventilation

Make sure that the dryer is installed in a room free of humidity and with adequate air circulation. The flow of air around the dryer is essential to allow water to condense during drying; the dryer will not function properly if it is placed in an enclosed space or inside a cabinet. Some condensation may form if the dryer is used in a small or cold room.

Water drain

If your dryer is installed next to a drain the water can be plumbed into this drain. This does away with the need to empty the water container. If the dryer is stacked onto or installed next to a washing machine it can share the same drain. The height of the drain must be less than 3' (1 m) from the bottom of the dryer.

Remove existing hose from position shown in picture A and fit a suitable length of hose and connect as shown in picture B. The drain tube has to be below 1 m from the bottom of the Dryer. Make sure that the hose is not squashed or kinked when the dryer is in its final location.

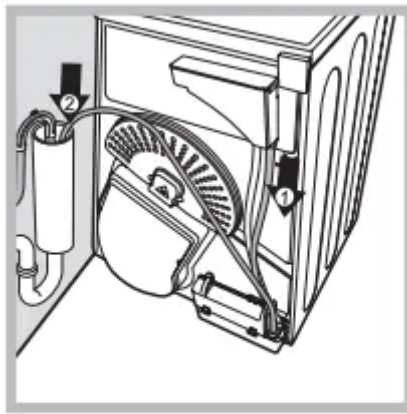

Picture A

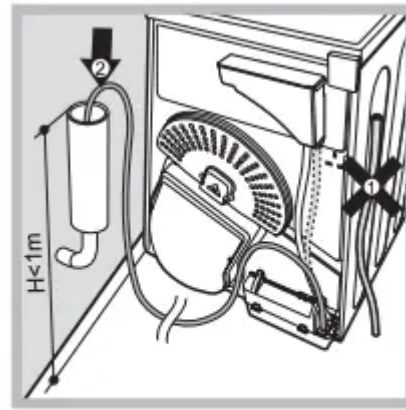

Picture B

We do not recommend that the dryer is installed in a cupboard but the dryer must never be installed behind a lockable door, a sliding door or a door with a hinge on the opposite side to that of the dryer door.

Electrical connections

Before plugging the appliance into the socket, check the following:

- ⚠ Make sure your hands are dry.
- ⚠ The socket must have an earth connection.
- ⚠ The socket must be able to withstand the machine's maximum power output as indicated on the rating plate.
- ⚠ The power supply voltage must fall within the values indicated on the data plate.
- ⚠ Do not use extension leads. Do not pull the power supply cable. Do not use multiple plug adaptors if the appliance is fitted with a plug. For appliances with fitted plug, if the plug is not suitable for your socket outlet, contact a qualified technician.

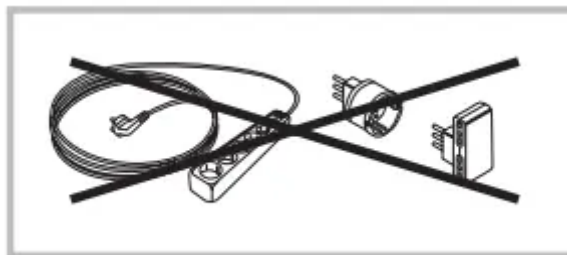

- ⚠ The dryer must not be installed outdoors, even if the space is sheltered.
- ⚠ Once installed, the dryer's electrical wire and plug must be within reach.
- ⚠ The power cord must not be bent or squashed.

 If the plug being replaced is a non-rewirable type, then the cut-off plug must be disposed of safely. DO NOT leave it where it can be inserted into a socket and create a shock hazard.

 The power must be regularly checked. If the supply cord is damaged, it must be replaced by service agent . (see Assistance).



 The manufacturer denies any responsibility should any of these rules not be followed.

 If in doubt about any of the above consult a qualified electrician.

Preliminary information

Once the tumble dryer is installed, clean the inside of the drum before operating it and remove any dirt accumulated during transportation.

Maximum load sizes: 9 kg

Power consumption			
off-mode (Po) - Watts			0.17
left-on mode (Pl) - Watts			0.17
Programs	Kg	kWh	Minutes
Standard cotton* 	9	5.16	161
Standard cotton 	4.5	2.85	97
Synthetics	3	1.27	55
* This is the reference program for the energy label and suitable to dry normal wet cotton laundry. This is the most efficient programme in terms of energy consumption for drying wet cotton laundry.			

Care and maintenance

Disconnecting the power supply

Disconnect the dryer when not in use or during cleaning and maintenance operations.

Cleaning the filter after each cycle

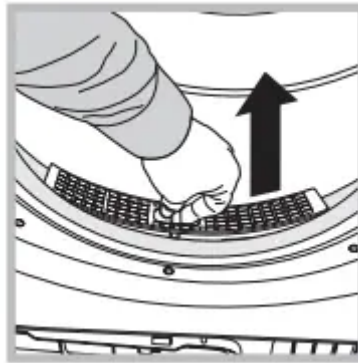

The filter is a fundamental component of the dryer: its function is to collect lint and fluff that form during drying.

Clean the filter once drying is completed, by rinsing it under running water or cleaning it with a vacuum cleaner.

Should the filter become clogged, the flow of air inside the dryer will be seriously hampered: drying times becomes longer and more energy is consumed.

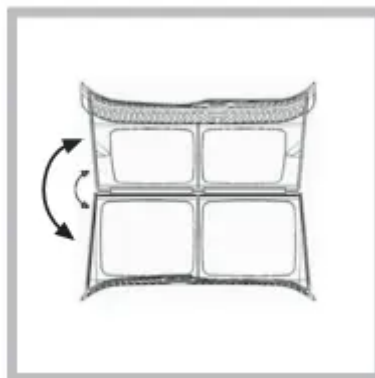

Moreover, the dryer may become damaged. The filter is located in front of the dryer seal (see Picture).

Removing the filter:

- Pull the filter's plastic handle upwards (see Picture).
- Clean the fluff off the filter and replace it correctly. Ensure that the filter is pushed fully home.

! Do not use the dryer unless the filter has been replaced in its holder.

Checking the drum after each cycle

Rotate the drum manually to remove smaller items (handkerchiefs) that could have been left inside the dryer.

Cleaning the drum

! Avoid using abrasives, steel wool or stainless steel cleaning agents to clean the drum. A coloured film may appear on the stainless steel drum surface: it may be caused by a combination of water and/or cleaning agents such as wash-softeners. This coloured film does not affect the dryer's performance.

Emptying the water container after each cycle

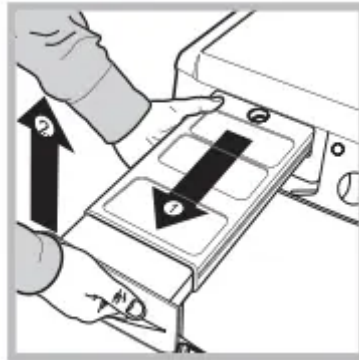

Remove the water container and empty it into a sink or other suitable drain outlet, then replace it correctly. Always check the water container and empty it before starting a new drying cycle.

-Failure to empty the water container may cause the following:

- The dryer stops heating (thus the load may still be damp at the end of the drying cycle).

Priming the Water Collection System

When your dryer is new, the Water Container will not collect Water until the system is primed, this will take 1 or 2 drying cycles. Once primed it will collect Water during every cycle.

Cleaning the condenser unit.

- Remove the condenser (see Picture below) unit regularly (monthly) and clean off any fluff deposits from the plates by rinsing it with cold water running on the rear end of the condenser.

Removing the condenser:

1. Disconnect the dryer from the power supply and open the door.
2. Open the condenser cover (see Picture below), unlock the three catches by turning them 90° anti-clockwise, then pull on the grip to remove the condenser.
3. Clean the surface of the seals and replace the unit with the arrows pointing upwards, while making sure that the catches are securely fixed.

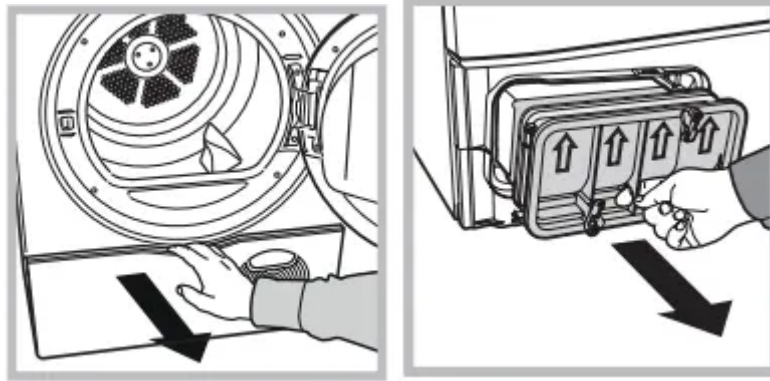

Cleaning the tumble dryer

- The external metal, plastic and rubber parts can be cleaned with a damp cloth.
- Clean the front air intake grille regularly (every 6 months) with a vacuum cleaner to remove any lint, fluff or dust deposits. Furthermore, remove any lint deposits from the front part of the condenser and from the filter area, using a vacuum cleaner every so often.

! Do not use solvents or abrasives.

! Have the dryer checked regularly by authorised technical personnel in order to ensure that the electrical and mechanical parts work safely (see Assistance).

Quick Tips

!Remember to clean your filter and Condenser unit after each load.

! Remember to empty your water container after each load.

! Doing this will keep your machine working at its BEST!

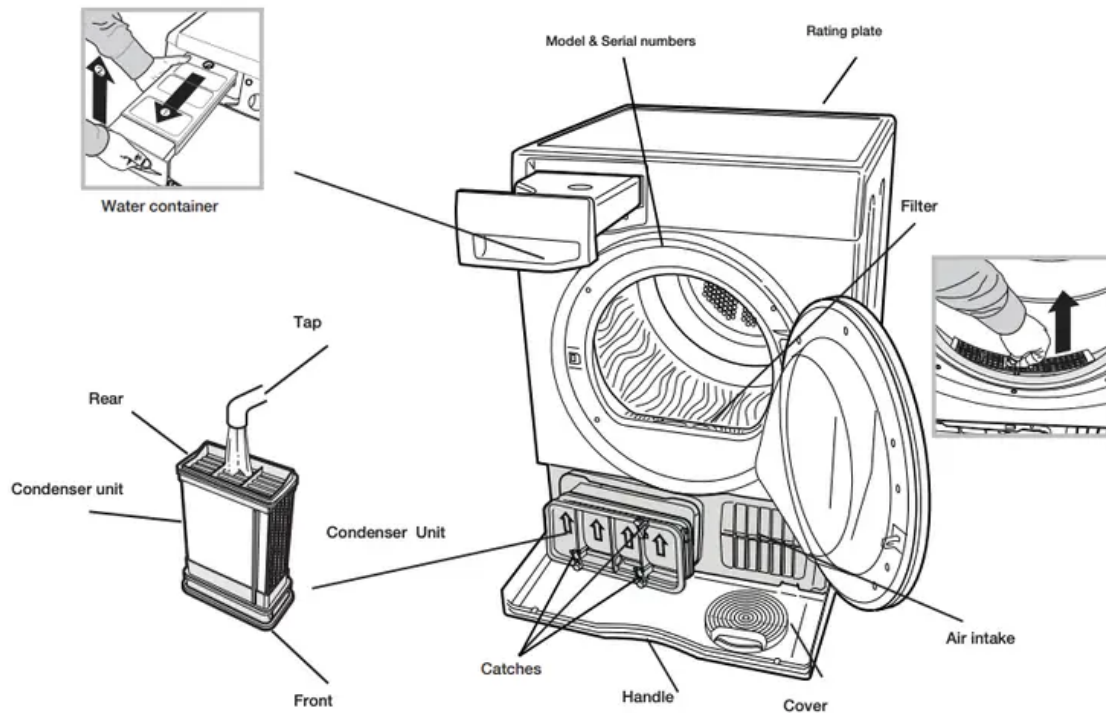

Control panel

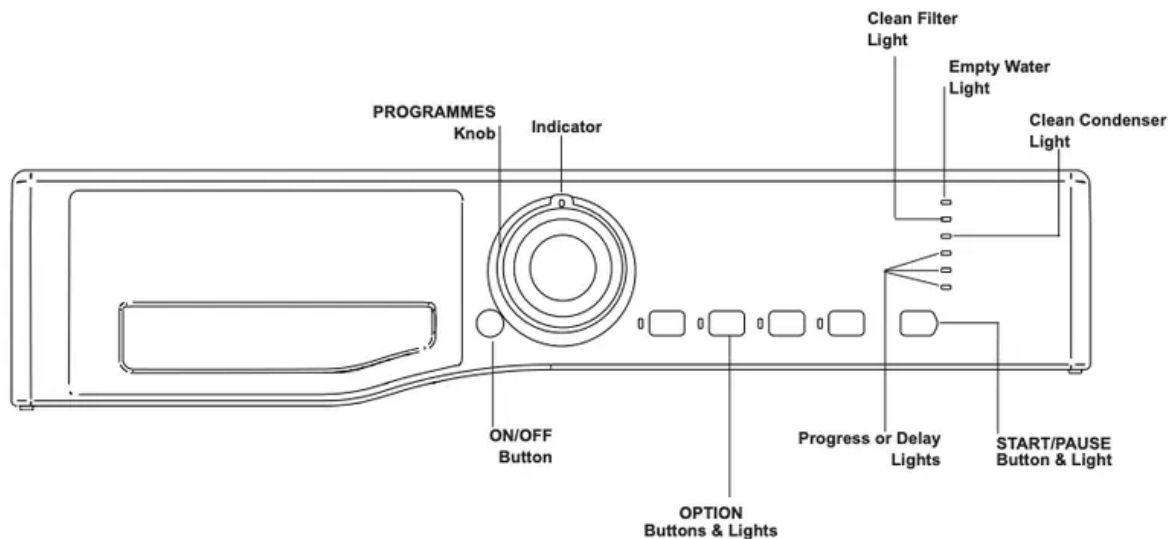

ON/OFF/Reset button

Pressing the button normally will cause the machine to switch on or off. If the button is pressed for 3 seconds while the dryer is in function, the machine will switch off and the running cycle will reset.

Programme selection knob

Allows for setting the programme: turn until the indicator points towards the desired programme (see Starting and selecting a programme).

Options buttons

Allow for selecting the options available for the selected programme. The relative indicator lights turn on when the option has been selected (see Programmes and options).

START/PAUSE button and indicator light

When the green light flashes slowly, press the button to start the programme. When the cycle is under way, the indicator light remains on. To put the programme into pause mode, press the button again; the indicator light will turn and start flashing again.

To resume the programme from the point it was interrupted, press the button again (see Start and programme selection).

Indicator lights

“Maintenance” indicator lights

The indicator lights provide important information. They indicate the following:

The “Empty water container” indicator light  signals that the water container must be emptied.

If the water container fills during the course of the programme, the LED lights up. The dryer automatically starts a COOL TUMBLE cycle and the START/PAUSE LED flashes orange. Press the START/PAUSE button to resume the cycle from the point it was interrupted.

In order to avoid this procedure, always empty the water container after using the tumble dryer

(see Care and maintenance). Before each programme, the “Clean filter” indicator light  signals that it is essential to clean the filter each time before using the tumble dryer (see Care and maintenance).

The “Clean condenser unit” indicator light  signals that it is essential to clean the condenser regularly (see Care and maintenance).

“Drying phases” indicator lights

The  indicator light signals that the drying phase is running.

The  indicator light signals that the cooling phase is running.

The END indicator light signals that the programme has ended.

“Delay timer” indicator light

If the “Delay timer” option has been activated (see “Programmes and options”), after the programme has started, the indicator light corresponding to the chosen delay time will start flashing: As time passes, the remaining delay will be displayed and the corresponding indicator

light will flash: Once the set delay time ends, the flashing LED will turn off and the set programme will start.

CARE LABEL

Always check the care labels, especially when placing garments in the tumble dryer for the first time. Below are the most commonly used symbols:

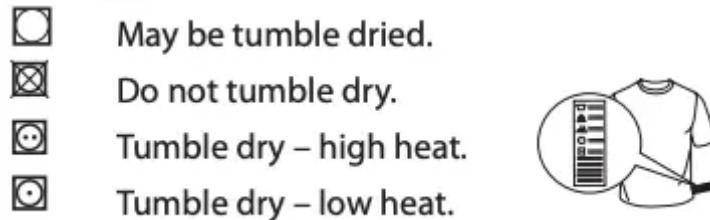

Start and Programmes

Starting and selecting a programme

1. Plug the dryer into the power supply socket.
2. Select the programme according to the type of laundry.
3. Open the door, ensure that the filter is clean and securely placed and that the water container is empty and correctly slotted (see Care and maintenance).
4. Load the machine, making sure that no piece of laundry gets between the door and the relative seal. Close the door.
5. Press the ON/OFF button to start the machine.
6. After consulting the programme chart and the indications for each type of fabric, turn the Programme selection knob towards the programme corresponding to the type of laundry to be dried (see Programmes and options).

Warning: If the position of the programme selection knob changes after pressing the START/PAUSE button, the selected programme will NOT be modified. To modify the programme, press the START/PAUSE button to put the programme in pause mode, then select a new programme and the relative options. Press the START/PAUSE button to start the new programme.

7. If necessary, set the 'time for the delayed start and any other options (see Programmes and options).
8. Press the START/PAUSE button to start the drying cycle. Laundry can be checked while the drying programme runs and any garments already dry can be removed, while drying continues for the remaining items. After closing the door, press the START/PAUSE button to resume machine operation.
9. The final COOL TUMBLE phase (i.e. the fabrics are cooled) activates during the last few minutes of the drying programme; always allow this phase to terminate.

10. When the END indicator light turns on, the programme has ended. The buzzer will beep 3 times to let you know that your programme is complete. Open the door, remove the laundry then clean the filter and replace it. Empty the water container and put it back in its slot (see Care and maintenance). If the “Crease Care” option was selected and laundry is not removed immediately, the drum will rotate garments at intervals for 10 hours or until the door is opened.

11. Disconnect the dryer from the power supply.

Standby mode

This tumble dryer, in compliance with new energy saving regulations, is fitted with an automatic standby system which is enabled after about 30 minutes if no activity is detected. Press and hold the ON/OFF button until the dryer reactivates.

n*	Programme Max. load	Description of program	Cycle duration*
1	Ready to Wear Max	Programme suitable for drying cotton garments ready to wear.	130'
2	Standard Cotton Max	Standard cotton programme, suitable to dry normally wet cotton laundry. Most efficient programme in terms of energy consumption for drying cotton laundry. The values on the Energy Label are based on this programme.	120'
3	Cotton Iron Dry Max	Drying for cotton garments intended to make ironing easier, immediately after the end of the cycle.	90'
4	Shirts 3 kg	*This is a programme for Shirts made from cotton or cotton blend/synthetics. *	75'
5	Anti Allergy Max	This cycle has the “Allergy UK” approval of “The British Allergy Foundation” attesting the effective reduction and elimination of allergens. It can be used both with damp load (drying and treatment) and dry load (half load only).	170'
6	Synthetics 3 kg	For drying laundry made of synthetic fibres or a mixture of synthetic/cotton fibres. Some fabrics may require a further timed dry period for the desired dryness level, we recommend smaller loads use a (low heat) timed programme 11 or 12 - without High Heat option.	60'
7	Jeans 3 kg	For drying cotton jeans-wear and garments made of robust cotton, like denim, such as trousers and jackets.	100'
8	Wool 1 kg	Programme for drying wool clothing. It is advisable to turn the garments inside out before drying. Leave to dry naturally the heaviest edges that are still damp.	60'
9	Silk 0.5 kg	Gentle drying of silk garments.	60'
10	Baby Delicate 2 kg	A programme intended to dry garments and linen of new-born babies (cotton and chenille), as well as delicate garments. Do not dry garments having plastic covering.	85'

***Note:** The duration of the program will depend on the size of the load, types of textiles, the spin speed used in your washer and any extra options selected

n°	Programme	Description of program	Cycle duration*
	Max. load	Notes/ Options available	
11 12	Short 30' Long 60'	These programmes can be used in order to set the drying time.	-
13	Cuddly Toy 2.5 kg	The cycle preserves the original appearance and brilliance of the cuddly toys at best. Remove all accessories before proceeding with drying. Every single piece must not exceed 600 gr.	200'
14	Heat & Enjoy	This programme helps to heat towels & bathrobes for a warm sensation after a bath or shower. It is also useful for warming clothes before dressing during winter. The cycle heats clothes to 37°C (Body Temperature) and runs at this temperature for a maximum of 4 hours or until you stop the cycle by opening the door.	-
15	Easy Iron	This cycle allows to extend the fibres of garments thus making ironing and folding easier. Do not use in case of garments that are still wet. Suitable for small loads of cotton textiles or cotton blends. The cycle duration is about 15 minutes.	-
16	Refresh	A short programme suitable for refreshing fibres and garments by means of fresh air. Do not use with garments that are still wet. It can be used on with any load size but is more effective with small loads. The cycle duration is about 20 minutes.	-

Options

The options allow for customising the selected programme according to one's own needs.

These buttons serves to personalise the selected programme according to personal requirements. Not all options are available for all programmes. Some options are incompatible with the ones previously set. The buzzer and/ or blinking indicators will signal the incompatibility. If the option is available, the option indicator will stay on. Some options may be kept in the memory of the programme if selected in the previous drying

High Heat

It improves the drying capacity. Option suitable for drying tough garments, it is used with timed cycles.

Quick Dry

Enables quicker drying.

Crease Care

The pre-care option is only available if a delayed start has been selected. It tumbles the clothes occasionally during the delayed period to help prevent creases developing. The post-care option occasionally tumbles the clothes after the end of the drying and cool tumble cycles to prevent creases developing, should you not be available to remove the load immediately the programme is complete. The End light is on during this phase.

Note: The Start/Pause light flashes during this phase. Selecting this option enables both the pre and post care functions if appropriate.

Delay timer

This option allows you to set the delay of the cycle start. Press the corresponding button several times to obtain the required delay. After having reached the max. settable time, the option is reset by pressing the button again. An indicator on the control panel signals the time being selected.

After having pressed the button Start/Pause, the machine signals the remaining time for the cycle start. In case of door opening, after closing, it is necessary to press the button Start/Pause.

Opening the door

If the door is opened (or the START/PAUSE button is pressed) while a programme is running, the dryer stops and the following may occur:

- The START/PAUSE button flashes orange.
- When a delayed start is running, the delay countdown continues. It is necessary to press the START/PAUSE button to resume the “Delay timer” programme. One of the “Delay timer” indicator light flashes to signal the delay time entered.
- It is necessary to press the START/PAUSE button to resume the programme. The progress indicator lights signal the running phase and the START/PAUSE indicator light stops flashing and turns green.
- During the post care phase, the programme ends. Pressing the START/PAUSE button reactivates a new programme from the beginning.
- By turning the Programme selection knob, a new programme is selected and the START/PAUSE indicator light flashes green. This procedure can be used to select the Cool tumble programme to cool garments if they are judged to be dry enough. Press the START/PAUSE button to start the new programme.

Note: If you have a power cut, switch off the power or remove the plug. When power is restored, plug in the machine, press and hold the ON/OFF button until the dryer reactivates, then press Start/Pause button.

Troubleshooting

If you feel that the dryer is not working properly, consult the following troubleshooting suggestions before contacting the Technical Assistance Centre (see Assistance).

The dryer does not start.

- The plug has not been inserted far enough into the socket to make contact.
- There has been a power cut.
- The fuse has burned out. Try connecting another appliance to the same socket.
- If an extension cord is used, try connecting the dryer plug directly into the socket.
- The door has not been closed properly.
- The programme has not been set correctly (see How to carry out a drying cycle).
- The START/PAUSE button has not been pressed (see How to carry out a drying cycle).

The drying cycle does not start.

- A delayed start time has been set (see Programmes and options).
- The START/PAUSE button has been pressed; a short delay follows before the dryer starts running. Wait for the drying cycle to start; do not press the START/PAUSE button otherwise the dryer switches to the pause mode and the drying cycle will not start.

Drying times are too long.

- The filter has not been cleaned (see Care and maintenance).
- The water container must be emptied? The “Empty water container” indicator light flashes (see Care and maintenance).
- The condenser needs to be cleaned (see Care and maintenance).
- The heat setting is not suited to the type of fabric to be dried (see Programmes and options).
- An incorrect drying time was selected for the type of load (see Laundry).
- The air intake grille or the rear air vents are clogged up (see Installation, and Care and maintenance).
- The items are too wet (see Laundry).
- The dryer is overloaded (see Laundry).

The “Empty water container” indicator light flashes.

- The water bottle was not emptied before starting the programme. Always empty it before starting a new drying programme (see Description of the tumble dryer) - do not wait for the bottle full signal (buzzer beeps once every 5 seconds and the indicator light flashes) before emptying the water container.

The programme is finished but the items are damper than expected.

- For safety reasons, the dryer programmes last a maximum of 5 hours. If an automatic programme has not detected the final dampness level required in this interval, the dryer completes the programme and stops. Check the above points and repeat the programme; if the items are still damp, contact the Technical Assistance Centre (see Assistance).

The “Options” and “START/PAUSE” indicator lights flash and one of the “Maintenance” or “Drying phases” indicator lights turns on without flashing.

- Switch the appliance off and unplug it, then clean the filter and condenser (see “Care and Maintenance”). Reinsert the plug, switch the appliance on and start another programme. If the problem persists, contact the Technical Assistance Service.

The dryer is noisy during the first few minutes of operation.

- This is normal, especially if the dryer has not been used for a long time. If the noise persists during the entire cycle, contact the Technical Assistance Centre.

The lights on the dryer control panel are off although the dryer is switched on.

The dryer has gone into standby mode to save power. This occurs if you have left the dryer on or have had a power cut. It occurs after 30 minutes:

- if you leave the dryer without starting a programme;
- after your drying programme has finished.

Press and hold the ON/OFF button until the dryer reactivates

Warning

This content is compiled from multiple sources and is provided for reference purposes only. It may not be complete or fully applicable to all situations. If you are unable to resolve your issue, please contact the product manufacturer or an authorized service provider for official support.