

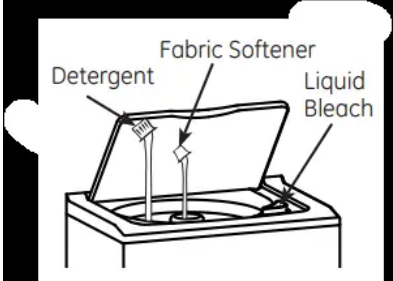



Operating Instructions

About the Washer control panel.

Quick Start Guide

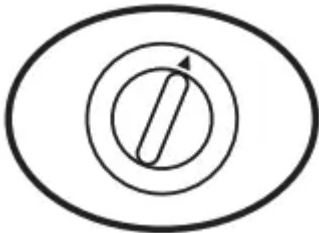
<p>STEP 1</p> <ul style="list-style-type: none">• Add detergent• Add fabric softener (optional)• Add bleach (optional).	
<p>STEP 2</p> <ul style="list-style-type: none">• Add clothes	
<p>STEP 3</p> <ul style="list-style-type: none">• Select load size and other wash options• Select wash cycle	
<p>STEP 4</p> <ul style="list-style-type: none">• Close lid• Push Start	

LID LOCKED



Your washer has a security system that prevents opening the lid during the spin cycle. The lid lock prevents anyone (especially children) from reaching into the washer while the basket is spinning. The lid lock will be release within 5 seconds after the basket stop spinning.

Trying to open the lid while locked could result in injuries. If the lid does not unlock after spinning, please contact service.

NOTE: If there is a power outage the lid lock can take 3 minutes to release.

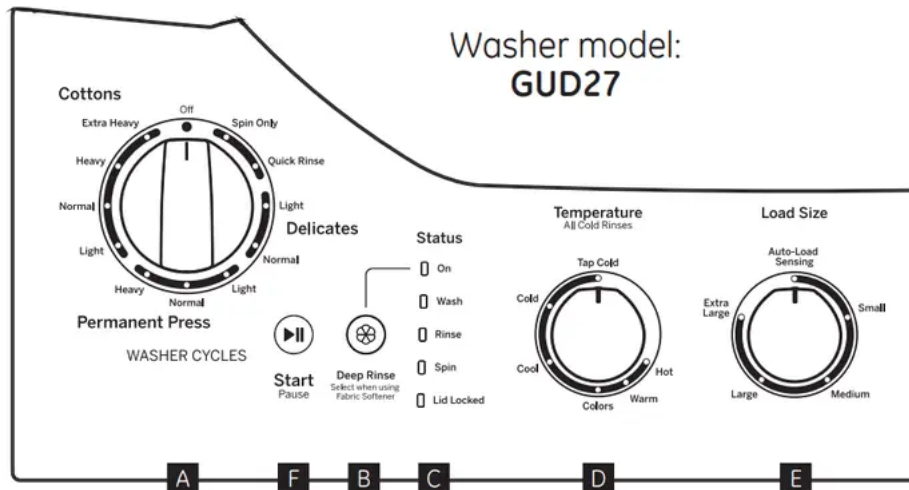

Note: This appliance is designed so that the washer and dryer can be operated at the same time.

A. Wash Cycle Selector

The wash cycle controls the length and intensity of the washing process. The knob can be turned in either direction. Turning the Cycle Selector knob after starting a cycle will stop the washer and reset the cycle to the new selection. Press Start to begin the new cycle selection.

The chart below will help you match the wash cycle setting with your clothing. The chart is ranked from longest to shortest cycle time and wash intensity. (Cycles vary by model.)

Power Clean - Uses more water than standard wash cycles. It is recommended for extra-large loads and heavily soiled clothes.

Cottons - For heavy to lightly soiled cottons, household linens, work and play clothes.

Permanent Press - For wrinkle-free and permanent press items, and knits.

Delicates - For lingerie and special-care fabrics with light to normal soil.

Quick Rinse - Rinses and spins non-soiled items where a rinse only is desired.

Spin Only - For draining the tub and spinning water out of clothes.

Off - Washer is turned off and the Start button does not function

NOTE: When the control is turned to OFF, the **Status** lights are off.

NOTE: The cycle selector does not rotate during the operation of the washer.

B. Deep Rinse

Set this option when adding fabric softener to the washer.

C. Status lights

The **Status** lights show the stage the washer is in. When the selector knob is set to a new cycle, the **Status** lights will flash momentarily, showing the stages the cycle will go through.

Status light	Illuminates
On	When the fabric softener option has been selected.
Wash	When the washer is in the wash portion of the cycle.
Rinse	When the washer is in the rinse portion of the cycle.
Spin	When the washer draining and/or spinning.
Lid Locked	When the washer lid is locked. This feature prevents the lid from being opened while the washer is in the spin cycle or coasting to a stop.

D. Temperature

Select the water temperature for the wash cycle (all rinses use cold water). Always follow fabric manufacturer's care label or instructions when laundering.

Tap Cold* uses incoming tap water, which can provide energy savings. For all other temperature selections, a mixture of hot and cold water is used to achieve the ideal temperature for each temperature setting.

*Please note that some detergents do not fully dissolve in very cold water. If you experience this, it is recommended you choose a setting other than **Tap Cold**.

E. Load Size

Loosely load clothes no higher than the top row of holes in the washer basket.

Auto Load Sensing- This selection automatically provides the correct amount of water suited to the size and type of load placed in the unit.

F. Start

Press **Start** to begin the cycle. With the lid closed pressing **Start** again will pause the cycle and **Status** lights will blink. To continue the cycle, close the lid and press **Start** again. The water fill will continue with the lid opened, except when **Auto Load Sensing** is selected as the load size. (The lid must be closed to continue filling when **Auto Load Sensing** is selected.)

If the lid is opened during the cycle, the cycle will pause and the **Status** lights will blink. To resume the cycle, close the lid and press **Start**.

If the machine is paused for more than 24 hours, the cycle will be cancelled. To stop the cycle, turn the Cycle Selector to the **Off** position.

About the Washer features.

The Fabric Softener Dispenser



The fabric softener dispenser automatically releases liquid fabric softener at the proper time during the cycle.

Do not stop the washer during the first spin. This will cause the dispenser to empty too soon.

To use, follow these steps:

1. Make sure dispenser is securely attached to .
2. Use only diluted liquid fabric softener. Pour into dispenser, using amount recommended on package.

Never pour fabric softener directly on clothes. It may stain them.

NOTE: Do not pour bleach into FABRIC SOFTENER dispenser.

3. Add water to dispenser until it reaches the maximum fill line.



Do not pour anything into the agitator if the dispenser is removed.

4. Select **FABRIC SOFTENER** button on control panel for proper dispersion of the fabric softener.

Cleaning the Fabric Softener Dispenser

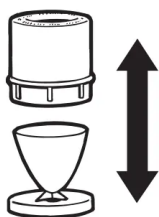

Separate for cleaning

1. Remove the dispenser from the top of the agitator.
2. Separate the dispenser cup from the cover by grasping the top and pushing down on the inside of the cup with your fingers. Dispenser cup will pop free from the cover.
3. To clean the dispenser, soak both the dispenser cup and the dispenser cover in the following solution:
 - 1 US gallon (3.8 liters) warm water
 - 1/4 cup (60 ml) heavy-duty liquid detergent
 - 1 cup (240 ml) bleach
4. If necessary, loosen buildup with a clean, soft cloth after soaking. Do not use a stiff brush; you may roughen the surface of the dispenser.
5. Rinse and reassemble dispenser. Place dispenser back on the agitator.

Care and Cleaning

Care and cleaning of the washer.

Wash Basket: Leave the lid open after washing to allow moisture to evaporate. If you want to clean the basket, use a clean soft cloth dampened with liquid detergent; then rinse. (Do not use harsh or gritty cleaners.)

Fill Hoses: GE recommends changing the hoses every 5 years.

Exterior: Immediately wipe off any spills. Wipe with damp cloth. Try not to hit surface with sharp objects.

Moving and Storage: Ask the service technician to remove water from drain pump and hoses. See the Installation Instructions packed with product for information on how to reinstall the shipping rod to keep the tub stationary when moving the washer. For more information, visit GEAppliances website or call 800. GE.CARES (800.432.2737).

In Canada, visit GEAppliances ca or call 800.561.3344. Do not store the washer where it will be exposed to the weather.

Long Vacations: Be sure water supply is shut off at faucets. Drain all water from hoses if weather will be below freezing.

Care and Cleaning of the Dryer.

The Exterior: Wipe or dust any spills or washing compounds with a damp cloth. Dryer control panel and finishes may be damaged by some laundry pretreatment soil and stain remover products. Apply these products away from the dryer. The fabric may then be washed and dried normally. Damage to your dryer caused by these products is not covered by your warranty.

The Lint Filter: Clean the lint filter before each use. Slide out the grid that covers the filter. Run your fingers across the filter. A waxy buildup may form on the lint filter from using dryer-added fabric softener sheets. To remove this buildup, wash the lint screen in warm, soapy water. Dry thoroughly and replace. Do not operate the dryer without the lint filter and grid in place. Have a qualified technician vacuum the lint from the dryer once a year.

Dryer Interior and Duct: The interior of the appliance and exhaust duct should be cleaned once a year by qualified service personnel.

The Exhaust Duct: Inspect and clean the exhaust ducting at least once a year to prevent clogging. A partially clogged exhaust can lengthen the drying time.

Follow these steps:

1. Turn off electrical supply by disconnecting the plug from the wall socket.
2. Disconnect the duct from the dryer.

3. Vacuum the duct with the hose attachment and reconnect the duct.

The Exhaust Hood: Check with a mirror that the inside flaps of the hood move freely when operating. Make sure that there is no wildlife (birds, insects, etc.) nesting inside the duct or hood.

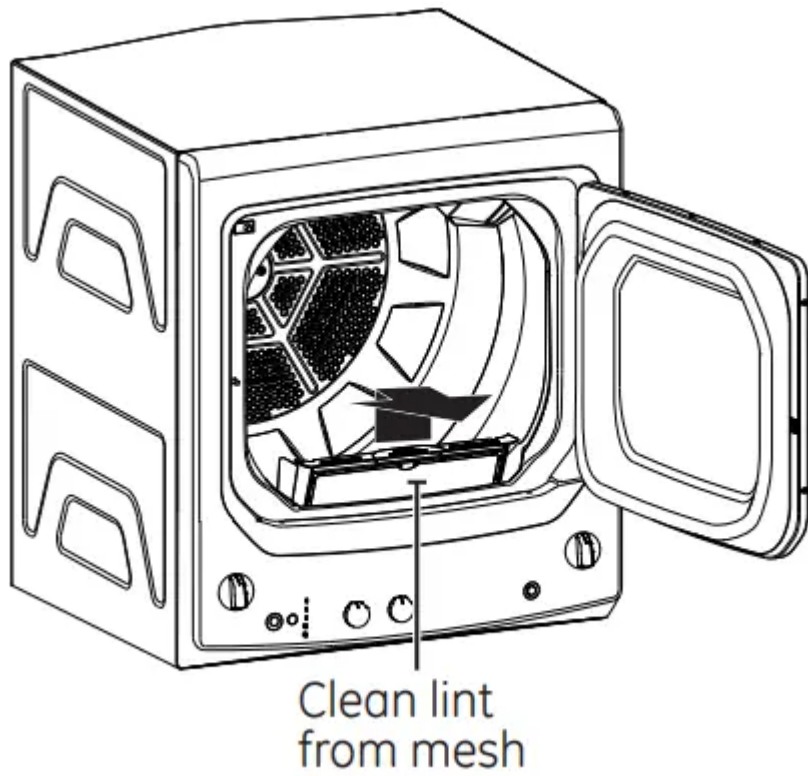

Troubleshooting



<i>Water</i>	<i>Possible Causes</i>	<i>What to do</i>
<i>Too many suds</i>	Too much detergent	Measure your detergent carefully. Use less soap if you have soft water, a smaller load or a lightly soiled load.
<i>Water leaks</i>	Using too much detergent	Use less detergent. Use less soap if you have soft water, a smaller load or a lightly soiled load.
	Fill hoses or drain hose is improperly connected	Make sure hose connections are tight at faucets and are installed. Make sure end of drain hose is correctly secured to drain facility.
	Household drain may be clogged	Check household plumbing. You may need to call a plumber.
	Constant water pressure to the fill hoses at the water source	Tighten hoses at the faucets and turn the water off after use. Check condition of the fill hoses; they should be replaced every 5 years.
<i>Water temperature seems incorrect</i>	Cooler water temperatures provide improved energy efficiency	New laundry detergents have been formulated to work at lower water temperatures without affecting wash performance.
	Water supply is turned off or improperly connected	Turn both hot and cold faucets fully on and make sure hoses are connected to correct faucets.
	Water valve screens are stopped up	Turn off the water source and remove the water valve screens from the upper back of the washer. Use a brush or toothpick to clean the screens in the machine. Reconnect the hoses and turn the water back on.
	House water heater is not set properly	Make sure house water heater is delivering water at 120°F (48°C-60°C).



<i>Water pumped out before cycle is complete</i>	Lid lifted or cycle was put in pause for over 24 hours	Reset cycle.
<i>Water won't drain</i>	Drain hose is kinked or improperly connected	Straighten drain hose and make sure washer is not sitting on floor. Drain outlet should be less than 8 ft (2.5 m) above floor.
<i>Washer pauses during spin cycle</i>	This is normal	The washer may pause during the spin cycle to remove lint more efficiently.
<i>Can hear but not see water at the end of the cycle</i>	This is normal	The pump leaves a little water in its intake and this is clean rinse water.



<i>Washer Operation</i>	<i>Possible Causes</i>	<i>What to do</i>
<i>Washer won't operate</i>	Washer is unplugged	Make sure cord is plugged securely into a working outlet.
	Water supply is turned off	Turn both hot and cold faucets fully on.
	Controls are not set properly	Check controls.
	Lid is open-safety feature prevents agitation and spinning when lid is up	Close lid and reset cycle, to the beginning if necessary.
	Circuit breaker/fuse is tripped/blown	Check house circuit breakers/fuses. Replace fuse or reset breaker. Washer should have separate outlet.
	Electronics need to be reset	Unplug washer, wait 2 minutes, plug back in and restart.
	Start was not pressed	Press Start .
	Lid magnet missing	Call for service.
<i>Movement inside machine when shut off</i>	Shifting mechanism is disengaging the motor	When the machine is manually turned off, the shifting mechanism disengages the motor before completely shutting off. If lid is raised before the motor is disengaged, it will vibrate when lid is closed.



<i>Washer Performance</i>	<i>Possible Causes</i>	<i>What to do</i>
<i>Clothes too wet</i>	<i>Incorrect spin cycle selected</i>	Make sure the spin cycle selected matches the load and fabric type. Some fabrics will feel wetter when rinsed with water.
<i>Colored spots</i>	<i>Incorrect use of fabric softener</i>	Check fabric softener package for instructions and directions for using dispenser. Pretreat stain and rewash.
	<i>Dye transfer</i>	Sort whites or lightly colored items from dark colors.
<i>Grayed or yellowed clothes</i>	<i>Not enough detergent</i>	Use more detergent (especially with larger loads) and follow detergent manufacturer's directions.
	<i>Hard water</i>	Use a water conditioner like Calgon brand or in-line water softener.
	<i>Water is not hot enough</i>	Make sure water heater is delivering water at 120°F (48°C-60°C).
	<i>Washer is overloaded</i>	Select load size to match clothes load.
	<i>Detergent is not dissolving</i>	Add detergent as wash basket fills with water before clothes.
	<i>Dye transfer</i>	Sort clothes by color. If fabric label states wash separately, unstable dyes may be indicated.
<i>Lint or residue on clothes</i>	<i>Clothes are air or line dried</i>	If you do not dry your clothes with a clothes dryer, they may retain more lint.
	<i>Incorrect sorting</i>	Separate lint producers from lint collectors.

Washing too long	Wash small loads for a shorter time than larger loads.
Detergent not dissolving	Add detergent as wash basket fills with water, before clothes.
	Try a liquid detergent.
	Use warmer water temperature.
Overloading	Load clothes no higher than the top row of holes in the basket.
Incorrect use of fabric softener	Check fabric softener package for instructions and directions for using dispenser.



Washer Performance	Possible Causes	What to do
Pilling	Result of normal wear on poly-cotton blends and fuzzy fabrics	While this is not caused by the washer, you can process by washing garments inside out.
Snags, holes, tears, rips or excessive wear	Pins, snaps, hooks, sharp buttons, belt buckles, zippers and sharp objects left in pockets	Fasten snaps, hooks, buttons and zippers.
		Remove loose items like pins, objects in pockets buttons.
		Turn knits (which snag easily) inside out.
	Undiluted chlorine bleach	Check bleach package instructions for proper amount.
		Never add undiluted bleach to wash or allow clothes contact with undiluted bleach.
Chemicals like hair bleach or dye, permanent wave solution	Rinse items that may have chemicals on them before washing.	
Wrinkling	Improper sorting	Avoid mixing heavy items (like work clothes) with light items (like blouses).
		Try a fabric softener.
	Overloading or incorrect water level	Load your washer so clothes have enough room to move with water covering all of the clothes.
	Incorrect wash and dry cycles	Match Cycle selection to the type of fabric you are washing (especially for easy care loads).
	Repeated washing in water that is too hot	Wash in warm or cold water.

Washer Sounds	Possible Causes	What to do
"Metallic clicking"	Shifter mechanism is engaging or disengaging	The drive system will engage at the start of agitate and disengage when agitate is complete. This occurs during the wash.
Back and forth "swoosh" or light "clicking" sound during agitate	Electric motor reversing direction	This machine has a drive system that doesn't use a clutch. The sound is the motor rotating back and forth to agitate laundry.
Quick short agitation sounds at end of agitate	Clothing redistribution	At the end of agitate, the motor makes short agitates to redistribute the load.
"Click" when water stops filling	Relay switch	The relay makes a click sound when activated. The relay activates the relay and stops filling.
"Clicking" behind Control Panel during fill	Automatic Temperature Control Valve	This valve mixes in cold and hot water. The "clicking" sound is the valve turning on and off.
Water volume changes during fill	Automatic Temperature Control Valve	This valve mixes in cold and hot water. The sound is the valve turning on and off.
Motor "whining up" or "coasting down" in spin	Motor ramping up/down during spin cycle	The motor will speed up incrementally during the spin cycle. When spin is complete, it will coast until it stops.
"Humming"	Water drain pump	The drain pump will make a humming sound when it starts drawing water after agitation stops and continues until spinning is complete.
"Gurgling"	Water drain pump	When the pump starts drawing in air, it starts to gurgling. The washer should then begin spinning and the sound will stop until it is done spinning.

<i>Dryer Problem</i>	<i>Possible Causes</i>	<i>What to do</i>
<i>Dryer doesn't start</i>	Dryer is unplugged	Make sure the dryer plug is pushed completely in.
	Fuse is blown/circuit breaker is tripped	Check the house fuse/circuit breaker box and reset breaker. Note: Most electric dryers use 2 fuses.
<i>Dryer doesn't heat</i>	Fuse is blown/circuit breaker is tripped; the dryer may tumble but not heat	Check the house fuse/circuit breaker box and reset both breakers. Your dryer may tumble if one fuse is blown or one breaker tripped.
	Gas service is off	Make sure gas shutoff at dryer and main shutoff are on.
<i>Dryer shakes or makes noise</i>	Some shaking/noise is normal. Dryer may be sitting unevenly	Move dryer to an even floor space, or adjust leveling legs if necessary until even.
<i>Greasy spots on clothes</i>	Improper use of fabric softener	Follow directions on fabric softener package.
	Drying dirty items with clean ones	Use your dryer to dry only clean items. Dirty items can transfer dirt to clean items and the dryer.
	Clothes were not completely clean	Sometimes stains which cannot be seen when they are wet appear after drying. Use proper washing procedure before drying.
<i>Lint on clothes</i>	Lint filter is full	Clean lint screen before each load.
	Improper sorting	Sort lint producers (like chenille) from lint collectors (like corduroy).
	Static electricity can attract lint	See suggestions in this section under STATIC.

	Overloading	Separate large loads into smaller ones.
	Paper, tissue, etc. left in pockets	Empty all pockets before laundering clothes.
<i>Static occurs</i>	No fabric softener was used	Try a fabric softener.
		Bounce® Fabric Conditioner Dryer Sheets have for use in all GE Dryers when used in accordance with manufacturer's instructions.
	Overdrying	Try a fabric softener.
		Adjust setting to <i>Less Dry</i> .
Synthetics, permanent press and blends can cause static	Try a fabric softener.	
<i>Inconsistent drying times</i>	Type of heat	Automatic drying times will vary according to the heat source used (electric, natural or LP gas), size of load, type of clothes, wetness of clothes and condition of exhaust duct.



Dryer Problem	Possible Causes	What to do
Clothes take too long to dry	Improper sorting	Separate heavy items from lightweight items (generally, a well-sorted washer load is a well-sorted dryer load).
	Large loads of heavy fabrics (like beach towels)	Large, heavy fabrics contain more moisture and take longer to dry. Separate large, heavy fabrics into smaller loads to reduce drying time.
	Controls improperly set	Match control settings to the load you are drying.
	Lint filter is full	Clean lint filter before every load.
	Improper or obstructed ducting	Check installation instructions for proper ducting.
		Make sure ducting is clean, free of kinks and unobstructed.
		Check to see if outside wall damper operates easily.
		Check the Installation Instructions to make sure venting is correct.
Blown fuses or tripped circuit breaker	Replace fuses or reset circuit breakers. Since most homes have two fuses/breakers, make sure both are operating.	
Overloading/combining loads	Do not put more than one washer load in the dryer.	
Underloading	If you are drying only one or two items, add a few more items to ensure proper tumbling.	
Clothes are wrinkled	Overdrying	Select a shorter drying time.
		Remove items while they still hold a slight amount of moisture. Select a Less Dry setting.



	Letting items sit in dryer after cycle ends	Remove items when cycle ends and fold or hang
	Overloading	Separate large loads into smaller ones.
<i>Clothes shrink</i>	Some fabrics will naturally shrink when washed. Others can be safely washed, but will shrink in the dryer	To avoid shrinkage, follow garment care labels e
		Some items may be pressed back into shape aft
		If you are concerned about shrinkage in a particu machine wash or tumble dry it.

Warning

This content is compiled from multiple sources and is provided for reference purposes only. It may not be complete or fully applicable to all situations. If you are unable to resolve your issue, please contact the product manufacturer or an authorized service provider for official support.

