

PARTS AND FEATURES

This manual covers different models. The oven you have purchased may have some or all of the items listed. The locations and appearances of the features shown here may not match those of your model.

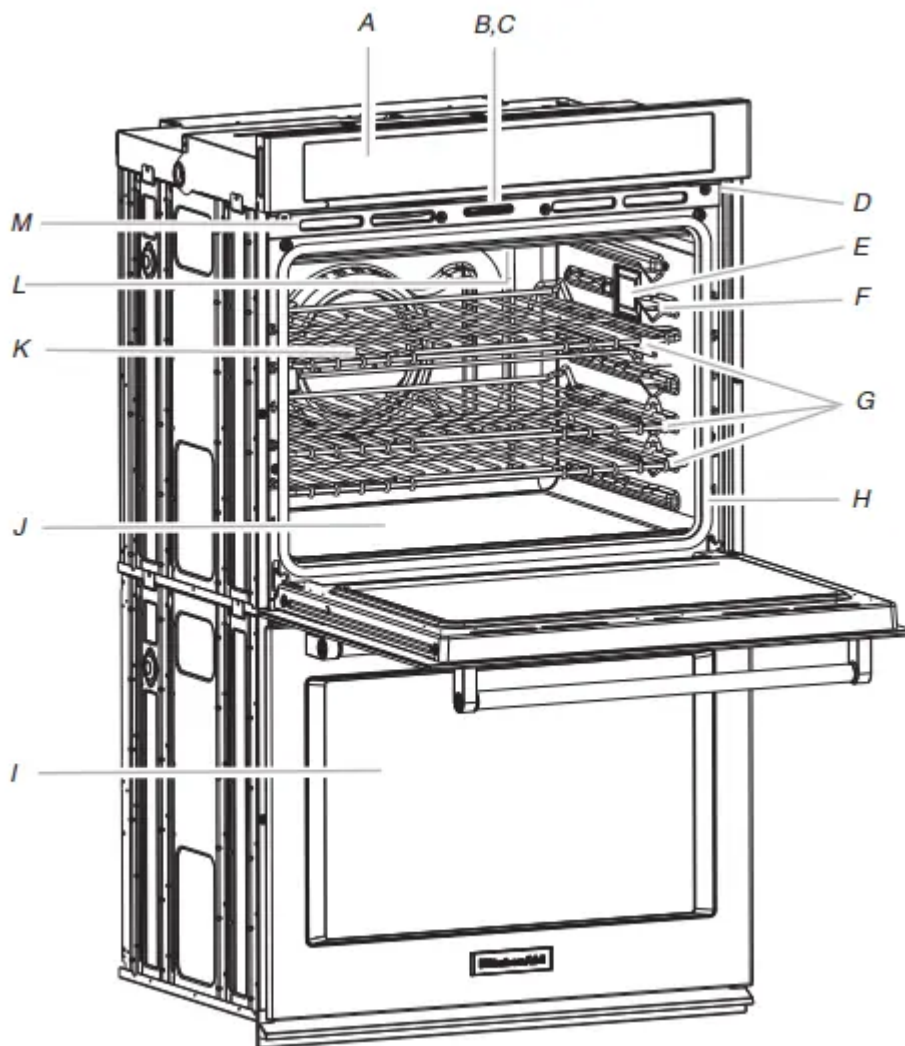

- A. Electronic oven control
- B. Automatic oven light switch
- C. Oven door lock latch
- D. Model and serial number plate (on bottom edge of control panel, right hand side)
- E. Oven lights
- F. Temperature probe jack (oven with
- G. Oven racks (roll-out racks available

- H. Gasket I. Lower oven (on double oven)
- J. CleanBake bake element (hidden beneath floor panel)
- K. Convection element and fan (in back panel)
- L. Broil elements (not shown) M. Oven vent

Parts and Features not shown Temperature probe

FEATURE GUIDE

WARNING Food Poisoning Hazard Do not let food sit in oven more than one hour before or after cooking. Doing so can result in food poisoning or sickness

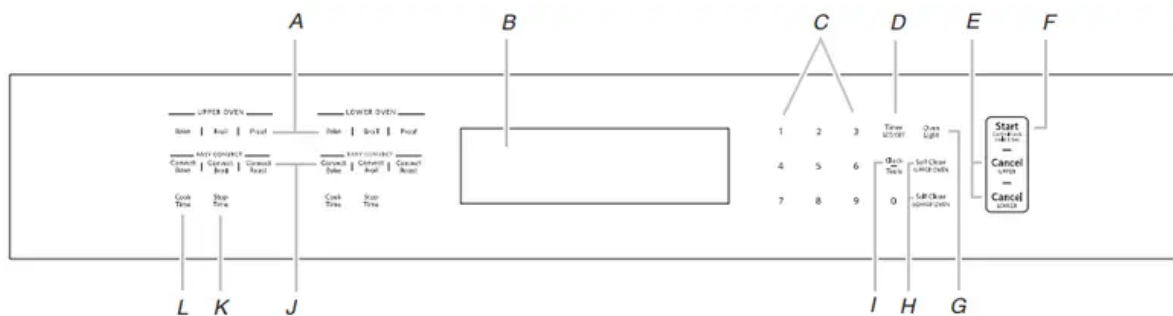

- A. Oven settings
- B. Oven display
- C. Number keys
- D. Kitchen timer
- E. Upper and lower oven Cancel (double oven models) Cancel (single oven models)
- F. Start/control lock
- G. Oven light
- H. Self clean
- I. Clock/Tools
- J. Convection cooking settings
- K. Stop time
- L. Cook time



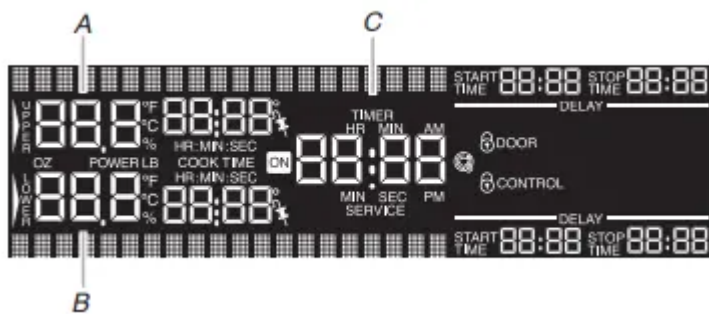

Double Oven Display

- A. Upper oven cavity display
- B. Lower oven cavity display
- C. Time of day, timer display

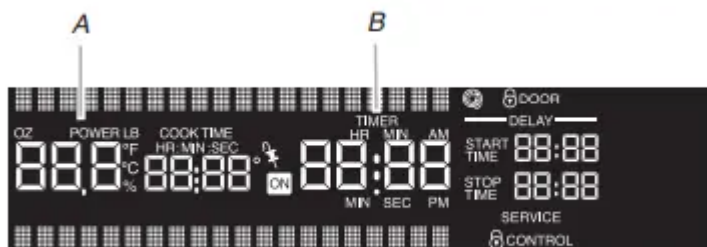

Single Oven Display

- A. Oven cavity display
- B. Time of day, timer display

CLOCK/TOOLS

- Clock
 - The Clock uses a 12 hour cycle. See the “Electronic Oven Controls” section.
1. Touch CLOCK/TOOLS.
 2. Touch the “1” key to select Clock. Then touch the number keys to set the time of day.
 3. Touch START.

CLOCK/TOOLS

- Settings
 - Enables you to personalize the audible tones and oven operation to suit your needs. See the “Electronic Oven Controls” section.



OVEN LIGHT

- Oven cavity light
 - The oven light is controlled by a key on the oven control panel. While the oven door is closed, touch OVEN LIGHT to turn the light on and off. When the oven door is opened, the oven light will automatically come on.

TIMER (SET/OFF)

- Oven timer
 - The Timer can be set in hours or minutes up to 23 hours and 59 minutes.
 - 1. Touch TIMER SET/OFF. Touch TIMER SET/OFF again to switch between MIN/SEC, HR/ MIN, and OFF. If no action is taken, the control will continue to wait for a length of time to be entered.
 - 2. Touch the number keys to set the length of time.
 - 3. Touch TIMER SET/OFF. If the key is not touched, the control will continue to wait for SET/ START to be touched. When the set time ends, 4 chimes will continuously repeat until the Timer Set/Off key is touched.
 - 4. Touch TIMER SET/OFF anytime to cancel the Kitchen Timer or stop the reminder tones. If CANCEL is touched, the respective oven will turn off. However, the kitchen timer can be turned off only by using TIMER SET/OFF.

START

- Cooking start
 - The Start key begins any oven function. If Start is not touched within 5 minutes after touching a key, the function is canceled and the time of day is displayed.

CANCEL UPPER CANCEL LOWER

- Range function
 - The Cancel keys stop any function for the appropriate oven except the Clock and Timer.

BAKE (Upper and Lower Oven)

- Baking and roasting
 - 1. Touch Upper Oven or Lower Oven BAKE. Touch the number keys to enter a temperature other than 350°F (177°C). The bake range can be set between 170°F and 550°F (77°C and 288°C).
 - 2. Touch START. "Lo" will appear on the oven display if the actual oven temperature is under 100°F (38°C), and "Preheating" will appear in the lower area of the display. When the actual oven temperature reaches 100°F (38°C),

the oven display will begin displaying the temperature as it increases. When the set temperature is reached, if on, one tone will sound.

- 3. Touch CANCEL for the selected oven when finished cooking.

BROIL

- Broiling

- Close the door.
- 1. Touch Upper or Lower BROIL. Touch the number keys to enter a temperature other than 550°F (288°C). The broil range can be set between 450°F and 550°F (232°C and 288°C).
- 2. Touch START. A long chime will sound. The set oven temperature will appear on the oven display until the oven is turned off.
- 3. Touch CANCEL for the selected oven when finished cooking.

EASY CONVECT BAKE

- Convect bake

- Before convection baking, position racks according to the “Rack And Bakeware Positions” section.

- 1. Touch Upper or Lower CONVECT BAKE.
- 2. Touch the number keys to choose whether or not to convert the recipe.
- 3. If “1: Yes” has been selected, you will see a screen with “easy convect bake.” Then touch the number keys to enter a temperature. The convection bake range can be set between 170°F and 550°F (77°C and 288°C). The oven temperature will automatically be reduced by 25°F (14°C) for EasyConvect™ Bake, and the adjusted temperature will show on the display, but the cook time will not be adjusted. Then touch the number keys to enter a cook time.
- **NOTE:** If a temperature between 170°F and 194°F (77°C and 90°C) is entered, the display will show only 170°F (77°C) and not the reduced temperature.
- 4. If “2: No” has been selected, Convect Bake will continue without conversion. Touch the “1” number key to use Rapid Preheat or “2” to continue without Rapid Preheat. Then touch the number keys to enter a temperature.
- **NOTE:** Rapid Preheat Convect Bake should only be used for 1-rack baking.
- 5. Touch START. “Lo” will appear on the oven display if the actual oven temperature is under 100°F (38°C), and “Preheating” will appear in the lower area of the display. When the actual oven temperature reaches 100°F (38°C), the oven display will show the oven temperature increasing. When the set temperature is reached, if on, 1 chime will sound.
- 6. Touch CANCEL for the selected oven when finished cooking.

EASY CONVECT ROAST

- Convect roast
 - 1. Touch Upper or Lower CONVECT ROAST.
 - 2. Touch the number keys to choose whether or not to convert the recipe.
 - 3. If “1: Yes” has been selected, you will see a screen with “easy convect roast.” Touch the number keys to enter a temperature. The convection roast range can be set between 170°F and 550°F (77°C and 288°C). Touch the number keys to enter a cook time. The cook time will automatically be adjusted to 80% of the time entered, and the adjusted cook time will appear on the display, but temperature will not be adjusted.
 - 4. If “2: No” has been selected, Convect Roast will continue without conversion. Touch the number keys to enter a temperature.
 - 5. Touch START. A long chime will sound. The set oven temperature will appear on the oven display until the oven is turned off.
 - 6. Touch CANCEL for the selected oven when finished cooking

CONVECT MODE

- Convect broil Close the door.
 - 1. Touch Upper or Lower CONVECT BROIL. Touch the number keys to enter a temperature other than 550°F (288°C). The convection broil range can be set between 450°F and 550°F (232°C and 288°C).
 - 2. Touch START. The set oven temperature will appear on the oven display until oven is turned off.
 - 3. Touch CANCEL for the selected oven when finished cooking.

PROOF

- Proofing bread
 - 1. Touch Upper or Lower PROOF. Display will show 100°F (38°C).
 - 2. Touch START. Let dough rise until nearly doubled in size, and then check at 20 to 25 minutes. Proofing time may vary depending on dough type and quantity.
 - 3. Touch CANCEL for the selected oven when finished cooking. Refer to the “Proofing Bread” section for more information.

STOP TIME

- Delayed start
 - The Stop Time key is used to enter the starting time for an oven function with a delayed start. Stop Time should not be used for foods such as breads and cakes because they may not bake properly.
 - To set Cook Time or Stop Time, see the “Timed Cooking” section.

COOK TIME

- Timed cooking
 - Cook Time allows the oven to cook for a set length of time, and/or shut off automatically. To set Cook Time or Stop Time, see the “Timed Cooking” section.

Electronic Oven Controls

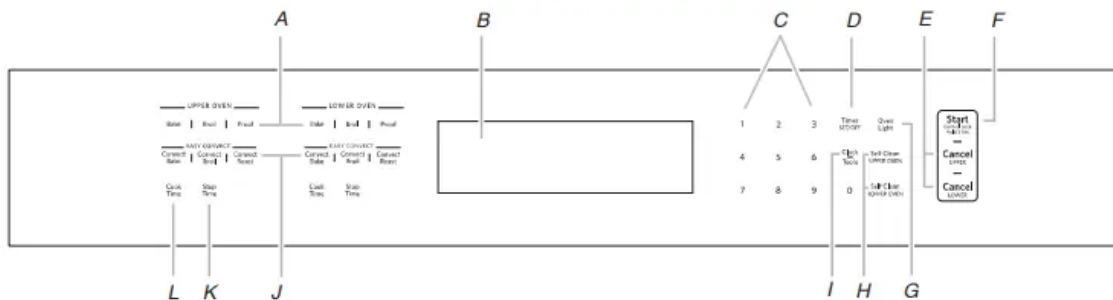

- A. Oven settings
- B. Oven display
- C. Number keys
- D. Kitchen timer
- E. Upper and lower oven cancel (double oven models) Cancel (single oven models)
- F. Start/control lock
- G. Oven light
- H. Self clean
- I. Clock/Tools
- J. Convection cooking settings
- K. Stop time
- L. Cook Time

Display

When power is first supplied to the oven, the timer display will flash “12:00”, and “Clock-Enter Time” will appear on the display. Enter the time by touching the number keys. Touch START to allow operation. To allow operation without setting a time, touch START or CANCEL.

Oven Display

When the oven(s) are in use, this display shows the oven temperature, heat source(s) and start time. On double oven models, this display will also show which oven is being set. The upper cavity symbol represents the upper oven; the lower cavity symbol represents the lower oven.

In addition, during Timed Cooking, this display shows a time countdown and the stop time (if entered). Time of Day, Timer Display When the oven(s) are not in use, this display shows the time of day or Timer countdow

Time of Day, Timer Display

When the oven(s) are not in use, this display shows the time of day or Timer countdown.

Start

The START key begins all oven functions except Sabbath Mode. If the Start key is not touched within 5 seconds after touching another key, “START?” will appear on the oven display as a reminder. If the Start key is not touched within 5 minutes after touching another key, the oven display will return to inactive mode and the programmed function will be canceled.

Lower Cancel, Upper Cancel and Cancel

The Lower Cancel, Upper Cancel and Cancel keys stop their respective oven functions except for the Clock, Kitchen Timer, and Control Lock. The oven cooling fan(s) may continue to operate even after an oven function has been canceled or completed, depending on the oven temperature.

Tones

Tones are audible signals, indicating the following:

One beep

Valid key touch

Function has been entered

One chime

Preheat cycle has been completed

Three beeps

Invalid key touch

Three chimes

End of a cooking cycle

Four chimes

When timer reaches zero Includes using the Kitchen Timer for functions other than cooking.

Tone Volume

The volume is preset at low, but can be changed to high. To Change: Touch TOOLS, and then “4” to toggle volume between high and low settings.

All Tones

All tones are preset on, but can be turned off. To Turn Off/On: Touch TOOLS, and then “3” to toggle tones between on/off settings.

End-of-Cycle and Reminder Tones

The Timed Cooking end-of-cycle and reminder tones are preset on, but can be turned off. If all tones have been turned off, the end-of-cycle and reminder tones cannot be independently turned on.

To Turn Off/On: Touch TOOLS, and then “5” to turn On. Touch TOOLS, and then “5” to turn Off.

NOTE: Turning off this reminder tone does not turn off the Kitchen Timer tone.

Fahrenheit and Celsius

The temperature is preset in Fahrenheit; however it can be changed to Celsius.

To Change: Touch TOOLS, and then “2” to toggle temperature between Fahrenheit and Celsius settings.

When the temperature is in Fahrenheit, “°F” follows the oven temperature.

When the temperature is in Celsius, “°C” follows the oven temperature.

Tools

The Tools selection key allows you access to 9 hidden functions within the Electronic Oven Control. These hidden functions allow you to set the clock, change the oven temperature between Fahrenheit and Celsius, turn the audible signals and prompts on and off, and adjust the oven calibration, change the language, and turn on the Demo Mode.

The Sabbath Mode is also set using the Tools selection key.

To Use: Touch CLOCK/TOOLS. The oven display will scroll through the various tools, starting at “1” and ending automatically at “9.” You can also touch the Tools key repeatedly to manually scroll through the list of tools.

| TOOLS | HIDDEN FUNCTION |
|-------|-----------------------------------|
| 1 | Clock |
| 2 | Fahrenheit and Celsius conversion |
| 3 | Sound On/Off |
| 4 | Sound High/Low |
| 5 | End tone On/Off |
| 6 | Calibration |
| 7 | Sabbath |
| 8 | Language |
| 9 | Demo Mode |

Clock

This is a 12 hour clock. Before setting, make sure the oven(s), Kitchen Timer, and Timed Cooking are off. To Set:

1. Touch CLOCK/TOOLS.
2. Touch the “1” key.
3. Select Clock, and then touch the number keys to set the time of day.
4. Touch START.

Kitchen Timer

The Kitchen Timer can be set in minutes and seconds or hours and minutes, and counts down the set time.

NOTE: The Kitchen Timer does not start or stop the oven.

Control Lock

The Control Lock shuts down the control panel keys to avoid unintended use of the oven(s). The Control Lock will remain set after a power failure, if set before the power failure occurs. When the control is locked, only the Start, Timer Set/Off and Oven Light keys will function.

The Control Lock is preset unlocked, but can be locked.

To Lock Control: Touch and hold START for approximately 3 seconds, until “Control Locked” appears on the lower text line and a lock icon appears in the display.

To Unlock Control: Repeat to unlock. “Control Unlocked” appears on the lower text line and the lock icon will be removed.

Oven Temperature Control

IMPORTANT: Do not use a thermometer to measure the oven temperature. Elements will cycle on and off as needed to maintain a consistent temperature but may run slightly hot or cool at any point

in time due to this cycling. Opening the oven door will affect cycling of the elements and impact the temperature.

The oven provides accurate temperatures and has been thoroughly tested at the factory. However, it may cook faster or slower than your previous oven, causing baking or browning differences. If necessary, the temperature calibration can be adjusted in either Fahrenheit or Celsius.

On double ovens, the upper oven and the lower oven can each be calibrated independently.

A minus sign means the oven will be cooler by the displayed amount. The absence of a minus sign means the oven will be warmer by the displayed amount. Use the following chart as a guide.

NOTE: The oven display will continue to show the original set temperature and will not reflect the calibration offset. For example, if set to 350° (177°C) and calibrated to -20, the display will continue to show 350° (177°C).

| ADJUSTMENT °F (AUTOMATIC °C CHANGE) | COOKS FOOD |
|--|--------------------|
| 10°F (6°C) | ...a little more |
| 20°F (12°C) | ...moderately more |
| 30°F (18°C) | ...much more |
| 0°F (0°C) | default setting |
| -10°F (-6°C) | ...a little less |
| -20°F (-12°C) | ...moderately less |
| -30°F (-18°C) | ...much less |

To Adjust Oven Temperature Calibration:

1. Touch TOOLS, and then “6” to set the calibration.
2. Touch the “1” key to select the upper oven or the “2” key to select the lower oven. Each oven calibration can be independently set.
3. Touch “3” to increase and “6” to decrease the temperature.
4. Touch START to end calibration.

Sabbath Mode

The Sabbath Mode sets the oven(s) to remain on in a bake setting until turned off. A timed Sabbath Mode can also be set to keep the oven on for only part of the Sabbath.

When the Sabbath Mode is set, the allowed keys are: the number keys, Start, Tools (to disable only), and Cancel. The display will scroll information on selecting the desired oven temperature.

When the oven door is opened or closed, the oven light will not turn on or off, and the heating elements will not turn on or off immediately.

If a power failure occurs when the Sabbath Mode is set, the oven(s) will remain in Sabbath Mode but will no longer be actively cooking. The “ON” indicator will no longer be lit. Touch Upper or Lower CANCEL to return to normal operating mode (non-Sabbath Mode, not cooking).

To Enable: Before the Sabbath Mode can be regularly set, the oven(s) must first be enabled with a one time only setup. On double oven models, the following step will enable both ovens

1. Touch CLOCK/TOOLS, and then touch number key “7.” “SABBATH MODE ON” will appear on the oven display for approximately 5 seconds.

To Disable:

The oven(s) can be disabled of the ability to set the Sabbath Mode by repeating the previous steps. See the “To Enable” section. When the oven(s) is disabled, “SABBATH MODE OFF” will appear on the display and remain on for approximately 5 seconds.

The Sabbath Mode cannot be regularly set until re-enabled.

On double oven models, these steps will disable both ovens.

To Regularly Set, Untimed to Activate:

Sabbath Mode must be enabled before starting the Bake cycle. See the “To Enable” section.

1. Touch Upper or Lower BAKE. Touch the number keys to enter a temperature other than 350°F (177°C). The bake range can be set between 170°F and 550°F (77°C and 288°C).

2. Touch START.

3. Touch CLOCK/TOOLS, and then number key “7.” “SABBATH MODE” will appear on the oven display

To Regularly Set, Timed:

WARNING Food Poisoning Hazard Do not let food sit in oven more than one hour before or after cooking. Doing so can result in food poisoning or sickness

Sabbath Mode must be enabled before starting the Bake cycle. See the “To Enable” section.

1. Touch Upper or Lower BAKE. Touch the number keys to enter a temperature other than 350°F (177°C). The bake range can be set between 170°F and 550°F (77°C and 288°C).

2. Touch COOK TIME.

3. Touch the number keys to enter the length of Sabbath Mode time, up to 11 hours 59 minutes.

4. Touch START. The oven will begin a timed bake cycle.

5. Touch CLOCK/TOOLS, and then touch number key “7.” “SABBATH MODE” will appear on the oven display. The start time and stop time will appear on the lower oven display.

6. When the stop time is reached, the oven will automatically turn off. The oven control will remain in Sabbath Mode until the Cancel button is touched.

Temperature Change

The oven temperature can be changed when the oven(s) are in the Sabbath Mode. No tones will sound, and the display will not change. The heating elements will not turn on or off for a random time, anywhere from 16 to 24 seconds. It may take up to one-half hour for the oven to change temperature.

Number keys "1" through "0" represent temperatures. Use the following chart as a guide.

| NUMBER KEY | OVEN TEMPERATURE |
|------------|------------------|
| 1 | 170°F (76°C) |
| 2 | 200°F (93°C) |
| 3 | 225°F (107°C) |
| 4 | 250°F (121°C) |
| 5 | 300°F (148°C) |
| 6 | 325°F (162°C) |
| 7 | 350°F (176°C) |
| 8 | 375°F (190°C) |
| 9 | 400°F (204°C) |
| 0 | 450°F (232°C) |

To Change Temperature:

Initially, on double ovens, the cavities can be set for independent temperatures. However, once Sabbath Mode is running, if the temperature is changed, both cavities will use the new temperature.

1. Touch the number key from the chart.
2. Touch START.

OVEN USE

Odors and smoke are normal when the oven is used the first few times, or when it is heavily soiled.

During oven use, the heating elements will not remain on, but will cycle on and off throughout oven operation.

IMPORTANT: The health of some birds is extremely sensitive to the fumes given off. Exposure to the fumes may result in death to certain birds. Always move birds to another closed and wellventilated room

Aluminum Foil

IMPORTANT: To avoid permanent damage to the oven bottom finish. do not line the oven bottom with any type of foil or liner.

- For best cooking results. do not cover entire rack with foil because air must be able to move freely.
- To catch spills. place foil on rack below dish. Make sure foil is at least 1/2" (1.3 cm) larger than the dish and that it is turned up at the edges.

Oven Racks

IMPORTANT: To avoid permanent damage to the porcelain finish. do not place food or bakeware directly on the oven door or bottom.

Racks

- Position racks before turning on the oven.
- Do not position racks with bakeware on them.
- Make sure racks are level.

To move a rack. pull it out to the stop position. raise the front edge. then lift out. Use the following illustration and charts as guides.

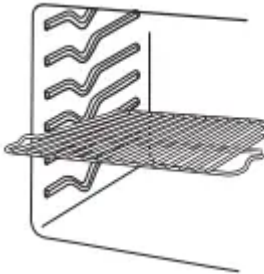

Rack and Bakeware Positions

Rack Positions - Upper And Lower Oven

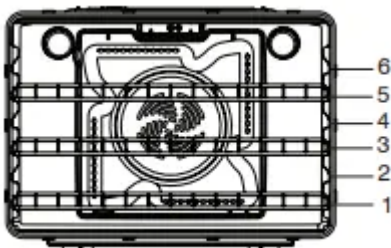

Broiling

- Most broiling
 - Rack Position: 6

For hamburger patties to have a well-seared exterior and a rare interior. use a flat rack in position 6. Side 1 should cook for approximately 3 minutes. Side 2 should cook for approximately 3 to 4 minutes. Expect a moderate degree of smoke when broiling.

Traditional Cooking

Large roasts. turkeys. angel food. bundt cakes. quick breads. pies

Rack Position: 1 or 2

Yeast breads. casseroles. meat and poultry

Rack Position: 2

Cookies. biscuits. muffins. cakes

Rack Position: 2 or 3 when single-rack baking; 2f and 5f when multi rack baking

Convection Cooking

| OVEN SETTING | NUMBER OF RACKS USED | RACK POSITION(S) |
|-------------------------------|----------------------|------------------|
| Rapid Preheat Bake | 1 | 3 |
| Rapid Preheat Convection Bake | 1 | 3 |
| Convection Bake | 1 | 1, 2 or 3 |
| Convection Bake | 2 | 2 and 5 |
| Convection Bake | 3 | 1, 3 and 5 |
| Convection Roast | 1 | 1 or 2 |
| Convection Broil | 1 | 4, 5 or 6 |

Baking Cakes on 2 Racks

For best results when baking cakes on 2 racks. use the Bake function and flat racks in positions 2 and 5. Place the cakes on the racks as shown. Keep at least 2 inches of space between the front of the racks and the front of the cakes.

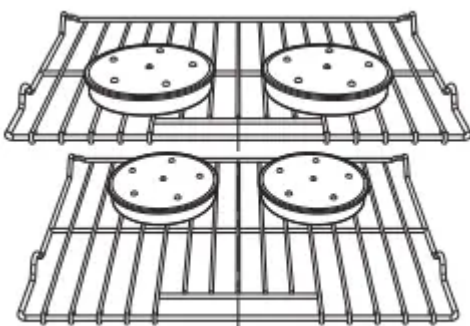

Baking Cookies on 2 Racks

For best results when baking cookies on 2 racks. use the Convection Bake function and place flat racks in positions 2 and 5.



Bakeware

To cook food evenly, hot air must be able to circulate. For best results, allow 2" (5 cm) of space around bakeware and oven walls.

Use the following chart as a guide.

- 1: Center of rack.
- 2: Side by side or slightly staggered.
- 3 or 4: See the rack position graphics in this section for pan placement recommendations.

SatinGlide Roll-Out Extension Rack

The SatinGlide roll-out extension rack allows easy access to position and remove food in the oven. It can be used in rack positions 1 through 6.

Open Position

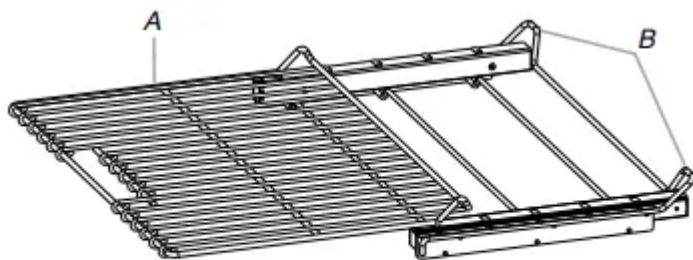

A. SatinGlide™ roll-out extension rack
B. Sliding shelf

Closed and Engaged Position

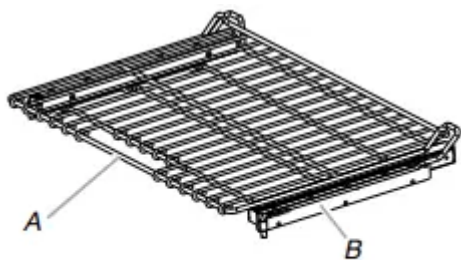

A. SatinGlide™ roll-out extension rack
B. Sliding shelf

To Remove SatinGlide Roll-Out Extension Rack:

1. Slide the rack in completely so that it is closed and engaged
2. Using 2 hands, lift up on the front edge of the rack and push

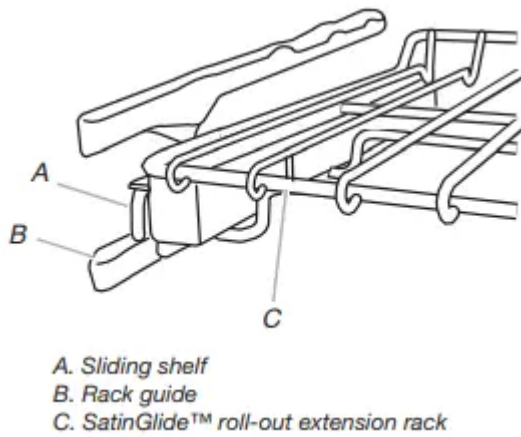

3. Pull the rack and the sliding shelf out.

To Replace SatinGlide Roll-out Extension Rack

1. Using 2 hands, grasp the front of the closed rack and the
2. Using 2 hands, lift up on the front edge of the rack and the
3. Slowly push the rack and the sliding shelf to the back of the

To avoid damage to the sliding shelves, do not place more than 25 lbs (11.4 kg) on the rack.

Do not clean the SatinGlide roll-out extension rack in a dishwasher. It may remove the rack's lubricant and affect its ability to slide.

See the "General Cleaning" section for more information.

Bakeware

The bakeware material affects cooking results. Follow manufacturer's recommendations and use the bakeware size recommended in the recipe. Use the following chart as a guide.

Light colored aluminum

- Light golden crusts
- Even browning
- Use temperature and time recommended in recipe.

Dark aluminum and other bakeware with dark, dull and/or nonstick finish

- Brown, crisp crusts
- May need to reduce baking temperatures slightly.
- Use suggested baking time.
- For pies, breads and casseroles, use temperature recommended in recipe.
- Place rack in center of oven.

Insulated cookie sheets or baking pans

- Little or no bottom browning
- Follow rack recommendations in the “Position Racks and Bakeware” section.
- May need to increase baking time.

Stainless steel

- Light, golden crusts
- Uneven browning
- May need to increase baking time.

Stoneware/Baking stone

- Crisp crusts
- Follow manufacturer’s instructions.

Ovenproof glassware, ceramic glass or ceramic

- Brown, crisp crusts
- May need to reduce baking temperatures slightly.

Meat Thermometer

Not all models have a temperature probe. On models without a temperature probe, use a meat thermometer to determine whether meat, poultry and fish are cooked to the desired degree of doneness. The internal temperature, not appearance, should be used to determine doneness.

Oven Vent(s)

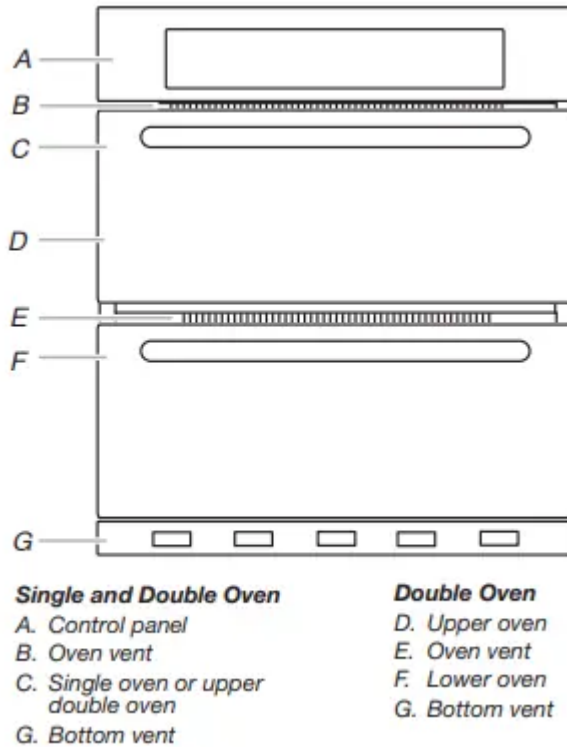

The oven vent(s) should not be blocked or covered since they allow the inlet of fresh air into the cooling system. Also, the bottom vent should not be blocked or covered since it allows the inlet of fresh air into the cooling system and the outlet of hot air from the cooling system. Blocking or covering vents will cause poor air circulation, affecting cooking, cleaning and cooling results.

Preheating and Oven Temperature

Preheating

When beginning a Bake or Convection Bake cycle, the oven begins preheating after Start is touched. The oven will take approximately 12 to 17 minutes to reach 350°F (177°C) with all of the oven racks provided with your oven inside the oven cavity. Higher temperatures will take longer to preheat. The preheat cycle rapidly increases the oven temperature. The actual oven temperature will go above your set temperature to offset the heat lost when your oven door is opened to insert food. This ensures that when you place your food in the oven, the oven will begin at the proper temperature. Insert your food when the preheat tone sounds. Do not open the door during preheat until the tone sounds.

Oven Temperature

While in use, the oven elements will cycle on and off as needed to maintain a consistent temperature. They may run slightly hot or cool at any point in time due to this cycling. Opening the oven door while in use will release the hot air and cool the oven which could impact the cooking time and performance. It is recommended to use the oven light to monitor cooking progress.

Baking and Roasting

IMPORTANT: The convection fan and convection element may operate during the Bake function to enhance performance and heat distribution.

The oven will take approximately 12 to 17 minutes to reach 350°F with all oven racks inside the oven cavity. The preheat cycle rapidly increases the temperature inside the oven cavity. Higher temperatures will take longer to preheat. Factors that impact preheat times include room temperature, oven temperature, and the number of racks. Unused oven racks can be removed prior to preheating your oven to help reduce preheat time. The actual oven temperature will go above the set temperature to offset the heat lost when the oven door is opened to insert food.

This ensures that the oven will begin at the proper temperature when you place food in the oven. Insert food when the preheat tone sounds. Do not open the door during preheat until the tone sounds.

During baking or roasting, the bake and broil elements will cycle on and off in intervals to maintain the oven temperature.

Depending on the model, if the oven door is opened during baking or roasting, the heating elements (bake and broil) will turn off approximately 30 seconds after the door is opened. They will turn on again approximately 30 seconds after the door is closed.

Broiling

Broiling uses direct radiant heat to cook food.

The element cycles on and off in intervals to maintain the oven temperature.

IMPORTANT: Close the door to ensure proper broiling temperature.

If the oven door is opened during broiling, the broil element will turn off in approximately 30 seconds. When the oven door is closed, the element will come back on approximately 30 seconds later.

- For best results, use a broiler pan and grid. It is designed to drain juices and help avoid spatter and smoke.
- If you would like to purchase a Broiler Pan Kit, it may be ordered. See “Accessories” section to order.
- For proper draining, do not cover the grid with foil. The bottom of the broiler pan may be lined with aluminum foil for easier cleaning.
- Trim excess fat to reduce spattering. Slit the remaining fat on the edges to avoid curling.
- Pull out oven rack to stop position before turning or removing food. Use tongs to turn food to avoid the loss of juices. Very thin cuts of fish, poultry or meat may not need to be turned.

- After broiling, remove the pan from the oven when removing the food. Drippings will bake on the pan if left in the heated oven, making cleaning more difficult.

Convection

In a convection oven, the fan-circulated hot air distributes heat more evenly. This movement of hot air helps maintain a consistent temperature throughout the oven, cooking foods more evenly, while sealing in moisture.

Most foods, using convection baking mode, can be cooked by lowering cooking temperatures 25°F (14°C). The cooking time can be shortened significantly when using Convection Roast, especially for large turkeys and roasts.

- It is important not to cover foods with lids or aluminum foil so that surface areas remain exposed to the circulating air, allowing browning and crisping.
- Keep heat loss to a minimum by opening the oven door only when necessary. It is recommended to use the oven light to monitor progress.
- Choose cookie sheets without sides and roasting pans with lower sides to allow air to move freely around the food.
- Test baked goods for doneness a few minutes before the minimum cooking time using a method such as a toothpick.
- Use a meat thermometer or the temperature probe to determine the doneness of meats and poultry. Check the temperature of pork and poultry in 2 or 3 places.

Convection Bake (on some models)

The convection element is hidden in the rear panel of the oven cavity, and assisted by the convection fan, provides balanced, efficient heating.

Convection baking can be used for baking delicate cakes and pastries, as well as foods on multiple racks. It is helpful to stagger items on the racks to allow a more even flow of heat. If the oven is full, extra cooking time may be needed.

When cooking an oven meal with several different types of foods, be sure to select recipes that require similar temperatures.

Cookware should sit in the oven with at least 2" (5 cm) of space between the cookware and the sides of the oven.

During convection baking preheat, the convection element, broil element and the CleanBake element all heat the oven cavity.

After preheat, the convection element, broil element and the CleanBake element will cycle on and off in intervals to maintain oven temperature, while the fan circulates the hot air.

If the oven door is opened during convection baking, the fan turns off immediately when the door is opened and turns on immediately when the door is closed. Convection, Bake and Broil elements will turn off approximately 30 seconds after the door is opened. They will turn on again approximately 30 seconds after the door is closed.

NOTE: It is normal for the convection fan to run during non convection cycles as well as during preheat.

- Reduce recipe temperature 25°F (14°C). The cook time may need to be reduced also.

To Convection Bake:

Before convection baking, position racks according to the “Rack and Bakeware Positions” section.

Convection Roast (on some models)

Convection roasting can be used for roasting meats and poultry.

During convection roasting, the broil, convection, and CleanBake elements will cycle on and off in intervals to maintain oven temperature, while the fan circulates the hot air.

If the oven door is opened during convection roasting, the fan turns off immediately when the door is opened and turns on immediately when the door is closed. Bake, broil, and convection elements will turn off approximately 30 seconds after the door is opened. They will turn on again approximately 30 seconds after the door is closed.

NOTE: It is normal for the convection fan to run during non convection cycles as well as during preheat.

To Convection Roast

Before convection roasting, position racks according to the “Rack and Bakeware Positions” section. It is not necessary to wait for the oven to preheat before putting food in, unless recommended in the recipe.

Convection Broil (on some models)

During convection broiling, the broil element will cycle on and off in intervals to maintain oven temperature, while the fan circulates the hot air.

The temperature is preset at 550°F (288°C), but can be changed to a different temperature. Cooking times will vary depending on the rack position and temperature and may need to be adjusted.

If the oven door is opened during convection broiling, fan turns off immediately when the door is opened and turns on again immediately when the door is closed. Broil elements will turn off approximately 30 seconds after the door is opened. They will turn on again approximately 30 seconds after the door is closed.

NOTE: It is normal for the convection fan to run during non convection cycles as well as during preheat.

To Convection Broil

Allow the oven to preheat for 5 minutes. Position food on the unheated grid on the broiler pan, and then place it in the center of the oven rack with the longest side parallel to the door.

Proofing Bread

Proofing bread prepares dough for baking by activating the yeast. Proofing twice is recommended unless the recipe directs otherwise.

To Proof

Before first proofing, place dough in a lightly greased bowl and cover loosely with waxed paper or plastic wrap coated with shortening. Place on rack guide 2. See "Rack and Bakeware Positions" for diagram. Close door.

1. Touch Upper or Lower PROOF. Display will show 100°F (38°C).
2. Touch START.

Let dough rise until nearly doubled in size, and then check at 20 to 25 minutes. Proofing time may vary depending on dough type and quantity.

3. Touch CANCEL for the selected oven when finished proofing.

Before second proofing, shape dough, place in baking pan(s) and cover loosely. Follow same placement, and control steps above. Before baking, remove waxed paper or plastic wrap.

Temperature Probe (single, upper and, on some models, lower oven)

The temperature probe accurately measures the internal temperature of meat, poultry and casseroles with liquid and should be used in determining the doneness of meat and poultry.

The temperature probe should only be used with Bake, Convection Bake or Convection Roast.

Always unplug and remove the temperature probe from the oven when removing food.

To Use

Before using, insert the probe into the food item. (For meats, the probe tip should be located in the center of the thickest part of the meat and not into the fat or touching a bone). Place food in oven and connect the temperature probe to the jack. Keep probe as far away from heat source as possible. Close oven door.

NOTE: The temperature probe must be inserted into the food item before the mode is selected.

1. Touch the number keys to enter a probe temperature. The
2. Touch Upper or Lower BAKE, CONVECTION BAKE or CONVECTION ROAST.

Touch number keys to enter an oven temperature other than the one displayed. The oven temperature is the temperature given in the recipe.

3. Touch START.

The set oven temperature will appear on the oven display throughout cooking. "Lo" will appear as the probe temperature until the internal temperature of the food reaches 45°F (7°C). Then the display will show the temperature increasing.

When the set probe temperature is reached, the oven will shut off automatically and "Cooking Complete" will appear on the oven display.

If enabled, end-of-cycle tones will sound, then reminder tones will sound every minute.

4. Touch CANCEL for the selected oven, or open the oven door

5. Always unplug and remove the temperature probe from the

To Change Probe Temperature During a Cooking Cycle

1. Touch a probe enabled cooking mode (Bake, Convection Bake or Convection Roast).

2. Follow steps 1 through 5 in the "To Use" section.

Timed Cooking

WARNING Food Poisoning Hazard Do not let food sit in oven more than one hour before or after cooking. Doing so can result in food poisoning or sickness

Timed Cooking allows the oven(s) to be set to turn on at a certain time of day, cook for a set length of time, and/or shut off automatically. Delay start should not be used for food such as breads and cakes because they may not bake properly.

To Set a Cook Time

1. Select a cooking function.

Touch the number keys to enter a temperature other than the one displayed.

Timed Cooking may also be used with the Bread Proof function, but the temperature is not adjustable.

2. Touch COOK TIME.

3. Touch number keys to enter the length of time to cook.

4. Touch START.

The minute time countdown will appear on the oven display. The start time and stop time are not displayed until the oven is finished preheating.

When the stop time is reached, the oven will shut off automatically, and "cooking complete" will appear on the oven display.

If enabled, end-of-cycle tones will sound, then reminder tones will sound every minute.

5. Touch CANCEL for the selected oven, or open and close the

To Set a Cook Time and Stop Time

Before setting, make sure the clock is set to the correct time of day. See “Clock” section.

1. Select a cooking function.

Touch the number keys to enter a temperature other than the one displayed.

Timed Cooking may also be used with the Bread Proof function, but the temperature is not adjustable.

2. Touch COOK TIME.

3. Touch number keys to enter the length of time to cook.

4. Touch STOP TIME.

5. Touch the number keys to enter time of day to stop.

6. Touch START.

The start time is automatically calculated and displayed. “DELAY” and the stop time will also appear on the oven display.

When the start time is reached, the oven will automatically turn on. The minute time countdown will appear on the oven display.

When the stop time is reached, the oven will shut off automatically, and “cooking complete” will appear on the oven display.

If enabled, end-of-cycle tones will sound, then reminder tones will sound every minute.

7. Touch CANCEL for the selected oven, or open and close the oven door to clear the display and/or stop reminder tones.

High Temp Self-Cleaning Cycle

WARNING Burn Hazard

Do not touch the oven during the Self-Cleaning cycle.

Keep children away from oven during Self-Cleaning cycle.

Failure to follow these instructions can result in burns.

IMPORTANT: The health of some birds is extremely sensitive to the fumes given off during the High Temp Self-Cleaning cycle. Exposure to the fumes may result in death to certain birds. Always move birds to another closed and well-ventilated room. Self-clean the oven before it becomes heavily soiled. Heavy soil results in longer cleaning and more smoke

Keep the kitchen well-ventilated during the High Temp Self-Cleaning cycle to help get rid of heat, odors, and smoke. Do not block the oven vent(s) during the High Temp Self-Cleaning cycle. Air must be able to move freely. Depending on your model, see “Oven Vent” or “Oven Vents” section. Do not clean, rub, damage or move the oven door gasket. The door gasket is essential for a good seal.

Prepare Oven:

- Remove the broiler pan, grid, cookware and bakeware and, on some models, the temperature probe from the oven.
- Remove oven racks to keep them shiny and easy to slide. See “General Cleaning” section for more information.
- Remove any foil from the oven because it may burn or melt, damaging the oven.
- Hand clean inside door edge and the 1½" (3.8 cm) area around the inside oven cavity frame, being certain not to move or bend the gasket. This area does not get hot enough during high temp self-cleaning to remove soil. Do not let water, cleaner, etc., enter slots on door frame. Use a damp cloth to clean this area.
- Wipe out any loose soil to reduce smoke and avoid damage. At high temperatures, foods react with porcelain. Staining, etching, pitting or faint white spots can res

How the Cycle Works

IMPORTANT: The heating and cooling of porcelain on steel in the oven may result in discoloring, loss of gloss, hairline cracks and popping sounds.

The High Temp Self-Cleaning Cycle uses very high temperatures, burning soil to a powdery ash.

The oven is preset for a 4 hour 30 minute clean cycle; however, the time can be changed.

Suggested clean times are 3 hours 30 minutes for light soil and between 4 hours 30 minutes and 5 hours 30 minutes for average to heavy soil.

Use the following chart as a guide to determine the desired cleaning level.

| CLEANING LEVEL | TOTAL CLEANING TIME (includes a 30 minute cool down time) |
|----------------|--|
| 1 (Quick) | 3 hours 30 minutes |
| 2 (Reg) | 4 hours 30 minutes |
| 3 (Maxi) | 5 hours 30 minutes |

Once the oven has completely cooled, remove ash with a damp cloth. To avoid breaking the glass, do not apply a cool damp cloth to the inner door glass before it has completely cooled.

The oven lights will not work during the High Temp Self-Cleaning cycle.

On double oven models, only one oven can self-clean at a time. If one oven is high temp self-cleaning, the other oven cannot be set or turned on.



NOTE: The oven has a 2 speed cooling fan motor. During self clean, the fan(s) will operate at its highest speed to increase airflow to better exhaust the hotter air through the oven vent(s). An increase in noise may be noticeable during and after the self-clean cycle until the oven cools.

To Start High-Temp Self-Cleaning

Before high temp self-cleaning, make sure the door is closed completely or it will not lock and the cycle will not begin.

1. Touch SELF CLEAN (Upper or Lower Oven). Touch SELF

CLEAN repeatedly to set a clean time other than 4 hours and 30 minutes. The clean time can be set between 3 hours and 30 minutes and 5 hours and 30 minutes.

Number keys cannot be used to set a clean time.

2. Touch START.

The oven will start locking the door and display “Locking Door.” Opening the door at this point will cancel the self-clean cycle. “Door Locked” will display once the door is locked.

Then, the start time and stop time will appear in the oven display.

When the cycle is complete and the oven is cool, “self clean complete” will appear on the oven display and “DOOR LOCKED” will disappear. The door will not unlock until the oven is cool.

If enabled, end-of-cycle tones will sound, then reminder tones will sound every minute.

3. Touch CANCEL for the selected oven, or open and close the

To Delay the Start of High Temp Self-Cleaning

Before starting a delayed High Temp Self-Clean cycle, make sure the clock is set to the correct time of day. See “Clock” section. Also, make sure the door is closed completely or it will not lock and the cycle will not begin.

1. Touch SELF CLEAN (Upper or Lower Oven). Touch SELF

CLEAN repeatedly to set a clean time other than 4 hours and 30 minutes. The clean time can be set between 3 hours and 30 minutes and 5 hours and 30 minutes.

Number keys cannot be used to set clean time.

2. Touch STOP TIME.

3. Touch the number keys to enter the time of day to stop.

4. Touch START.

The start time and stop time is automatically calculated and displayed.

The door will not lock until the start time is reached.

When the start time is reached, the oven will automatically turn on. The oven will start locking the door and will display "Locking Door." Opening the door at this point will cancel the self-clean cycle. "Door Locked" will display once the door is locked.

When the cycle is complete and the oven cools, "self clean complete" will appear on the oven display and "DOOR LOCKED" will disappear. The door will not unlock until the oven is cool.

5. Touch CANCEL for the selected oven, or open and close the

To Stop High Temp Self-Cleaning anytime:

Touch Upper or Lower CANCEL. If the oven temperature is too high, the door will remain locked. It will not unlock until the oven cools.

OVEN CARE

General Cleaning

IMPORTANT: Before cleaning, make sure all controls are off and the oven is cool. Always follow label instructions on cleaning products.

Soap, water and a soft cloth or sponge are suggested first unless otherwise noted.

STAINLESS STEEL (on some models)

To avoid damage to stainless steel surfaces, do not use soap-filled scouring pads, abrasive cleaners, Cooktop Cleaner, steel-wool pads, gritty washcloths or abrasive paper towels.

Cleaning Method:

- Rub in direction of grain to avoid damaging.
- Affresh Stainless Steel Cleaner Part Number W10355016 (not included) or affresh Stainless Steel Cleaning Wipes Part Number W10355049 (not included): See "Accessories" section to order.

OVEN DOOR EXTERIOR

Cleaning Method:

- Glass cleaner and a soft cloth or sponge: Apply glass cleaner to soft cloth or sponge, not directly on panel.
- Affresh Kitchen and Appliance Cleaner Part Number W10355010 (not included): See "Assistance or Service" section to order.

OVEN DOOR INTERIOR

Cleaning Method:

- Self-Cleaning cycle: For optimal door cleaning result, wipe away any deposits with a damp sponge before running cycle.

CONTROL PANEL

To avoid damage to the control panel, do not use abrasive cleaners, steel-wool pads, gritty washcloths or abrasive paper towels.

Cleaning Method:

- Glass cleaner and soft cloth or sponge: Apply glass cleaner to soft cloth or sponge, not directly on panel.
- Affresh Kitchen and Appliance Cleaner Part Number W10355010 (not included): See “Accessories” section to order.

OVEN CAVITY

Do not use oven cleaners.

Food spills should be cleaned when oven cools. At high temperatures, foods react with porcelain and staining, etching, pitting or faint white spots can result.

Cleaning Method:

- Self-Cleaning cycle: See “High Temp Self-Cleaning Cycle” first.

OVEN RACKS

Cleaning Method:

- Self-Cleaning cycle: See “High Temp Self-Cleaning Cycle” first. Remove racks or they will discolor and become harder to slide. If this happens, a light coating of vegetable oil applied to the rack guides will help them slide.
- Steel-wool pad

Oven Lights

The oven lights are 120 V, 40 W maximum halogen bulbs. They will come on when the oven door is opened. On double oven models, both upper and lower lights will come on when either door is opened. The oven lights will not work during the Self-Cleaning cycle. When the oven door is closed, touch OVEN LIGHT to turn light on or off.

To Replace:

Before replacing the bulb, make sure the oven is off and cool.

1. Disconnect power.
2. Remove glass light cover by grasping the front edge and pulling away from oven.

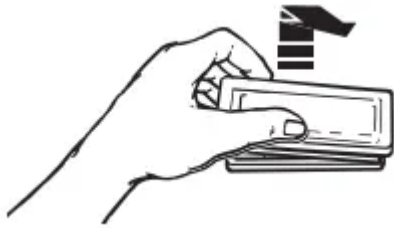

3. Remove bulb from socket.
4. Replace bulb. using tissue or wearing cotton gloves to handle
5. Replace bulb cover by snapping back into wall.
6. Reconnect power.

IMPORTANT: Do not use lamps rated higher than 40 W.

Oven Door

IMPORTANT:

To avoid oven door glass breakage:

- Do not close the oven door if the racks are not fully inserted into the oven cavity or when bakeware extends past the front edge of an oven rack.
- Do not set objects on the glass surface of the oven door.
- Do not hit glass surfaces with bakeware or other objects.
- Do not wipe down glass surfaces until the oven has completely cooled.

For normal oven use, it is not suggested to remove the oven door.

However, if removal is necessary, make sure the oven is off and cool. Then, follow these instructions. The oven door is heavy.

To Remove:

1. Open oven door all the way.
2. Flip up the hinge latch on each side.

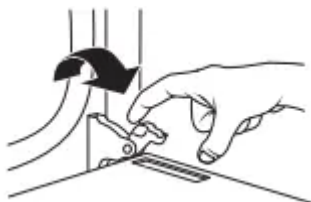

3. Close the oven door as far as it will shut.
4. Lift the oven door while holding both sides.

Continue to push the oven door closed and pull it away from the oven door frame.



To Replace:

1. Insert both hanger arms into the door.



2. Open the oven door.

You should hear a “click” as the door is set into place.

3. Move the hinge levers back to the locked position. Check that the door is free to open and close. If it is not, repeat the removal and installation procedures.

TROUBLESHOOTING

Try the solutions suggested here first in order to avoid the cost of an unnecessary service call.

Nothing will operate

- Has a household fuse blown. or has a circuit breaker tripped?
 - Replace the fuse or reset the circuit breaker. If the problem continues. call an electrician.

Oven will not operate

- Is the electronic oven control set correctly?
 - See “Electronic Oven Controls” section.
- Has a delay start been set?
 - See “Timed Cooking” section.
- Is the Control Lock set?
 - See “Control Lock” section.

- Is the Sabbath Mode set?
 - See “Sabbath Mode” section.
- On double oven models. is one oven self-cleaning?
 - When one oven is self-cleaning. the other oven cannot be set or turned on.

Oven temperature too high or too low

- Does the oven temperature calibration need adjustment?
 - See “Oven Temperature Control” section.

Warm air coming from oven vent

- Warm air coming from the oven vent is normal. During a self-clean cycle. the air stream is increased.
- The cooling fan may operate both during an oven’s cycle and after the cycle has ended. causing warm air to exit from the oven vent.

Display shows messages

- Is the display showing a letter followed by a number?
 - Clear the display. See “Display(s)” section. If a letter followed by a number reappears. call for service. See “Warranty” section.

Fan runs during Bake function

- It is normal for the convection fan and element to operate during Bake mode to enhance performance and heat distribution.

Long preheat times

- Not all cycles require preheating. See cycle instructions for preheat recommendations. Most cycles preheat to 350°F (177°C) in 12 to 17 minutes. Higher temperatures will take more time. Removing unused oven racks prior to preheating can help reduce preheat time.

Self-Cleaning cycle will not operate

- Is the oven door open?
 - Close the oven door all the way.
- Has the function been entered?
 - See “Self-Cleaning Cycle” section.
- On some models. has a delay start Self-Clean cycle been set?
 - See “Self-Cleaning Cycle” section.



- Has a delay start been set?
 - See “Timed Cooking” section.
- On double oven models. is one oven self-cleaning?
 - When one oven is self-cleaning, the other oven cannot be set to self-clean.

Oven cooking results not what expected

- Is the proper temperature set?
 - Double-check the recipe in a reliable cookbook.
- Is the proper oven temperature calibration set?
 - See “Oven Temperature Control” section.
- Was the oven preheated?
 - See “Baking and Roasting” section.
- Is the proper bakeware being used?
 - See “Bakeware” section.
- Are the racks positioned properly?
 - See “Rack and Bakeware Positions” section.
- Is there proper air circulation around bakeware?
 - See “Rack and Bakeware Positions” section.
- Is the batter evenly distributed in the pan?
 - Check that batter is level in the pan.
- Is the proper length of time being used?
 - Adjust cooking time.
- Has the oven door been opened while cooking?
 - Oven peeking releases oven heat and can result in longer cooking times.
- Are baked items too brown on the bottom?
 - Move rack to higher position in the oven.
- Are pie crust edges browning early?
 - Use aluminum foil to cover the edge of the crust and/or reduce baking temperature.

Uneven browning of baked items

- See “Rack and Bakeware Positions” section.

- Center the baking pan(s) on the rack and allow a minimum of 2" (5 cm) of clearance around all sides of the pan(s).
- Allow a minimum of 2" (5 cm) of clearance between the oven door and the front edge of baking pans.

Warning

This content is compiled from multiple sources and is provided for reference purposes only. It may not be complete or fully applicable to all situations. If you are unable to resolve your issue, please contact the product manufacturer or an authorized service provider for official support.